

# 1

## Chapter 1: Walking Across the Playground

$$a = \begin{pmatrix} a_0 \\ a_1 \\ \vdots \\ a_n \end{pmatrix}$$

$$a = \begin{pmatrix} a_{00} & a_{01} & a_{02} \\ a_{10} & a_{11} & a_{12} \\ a_{20} & a_{21} & a_{22} \end{pmatrix}$$

$$a = \begin{pmatrix} 2 & 5 & 7 \\ 10 & 3 & 5 \\ 4 & 1 & 4 \end{pmatrix}$$

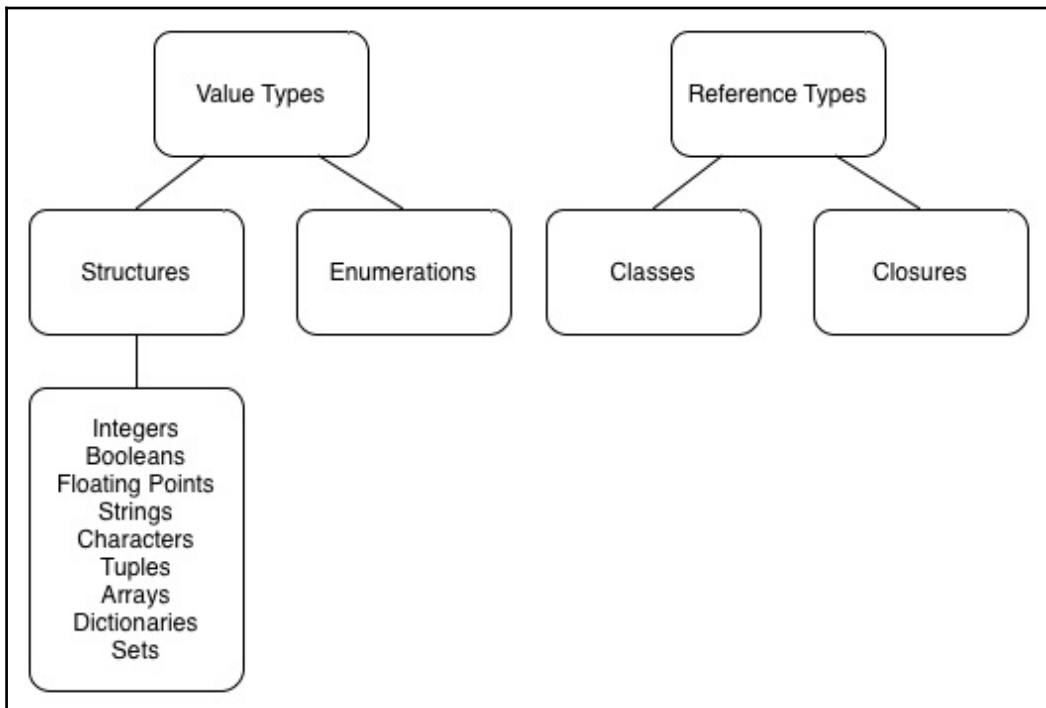
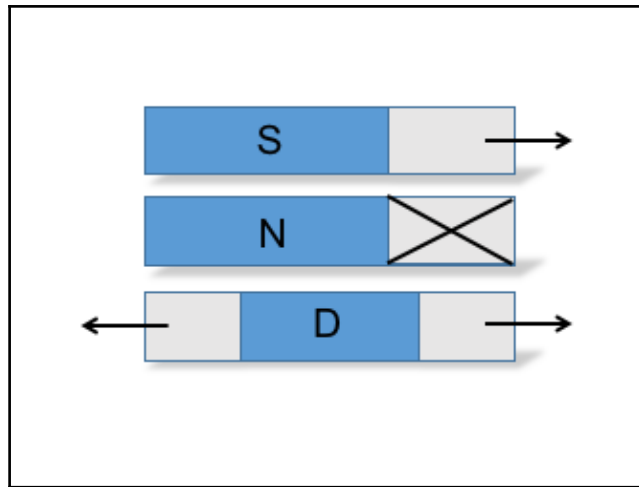

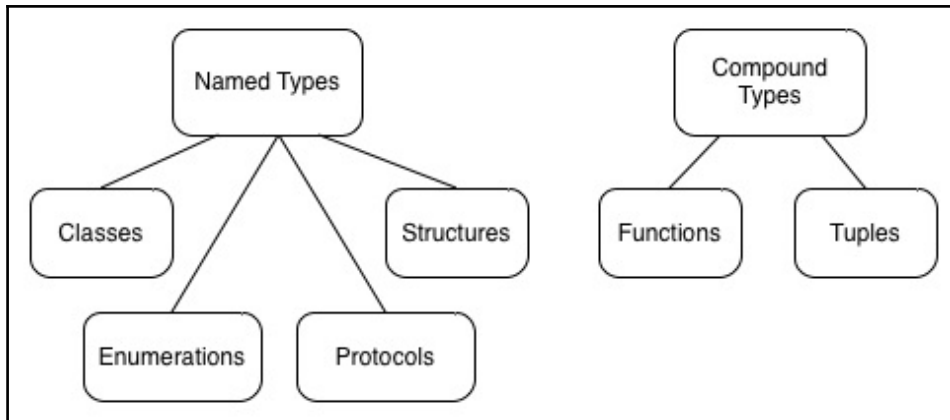

Step 1	56	17	63	34	77	52	68	Assume first item is sorted
Step 2	17	56	63	34	77	52	68	17 < 56 so insert it
Step 3	17	56	63	34	77	52	68	63 > 56 so leave it where it is
Step 4	17	34	56	63	77	52	68	34 < 63; 34 < 56; 34 > 17 so insert it
Step 5	17	34	56	63	77	52	68	77 > 63 so leave it where it is
Step 6	17	34	52	56	63	77	68	52 < 77; 52 < 63; 52 < 56; 52 > 34 so insert it
Step 7	17	34	52	56	63	68	77	68 < 77; 68 > 63 so insert it

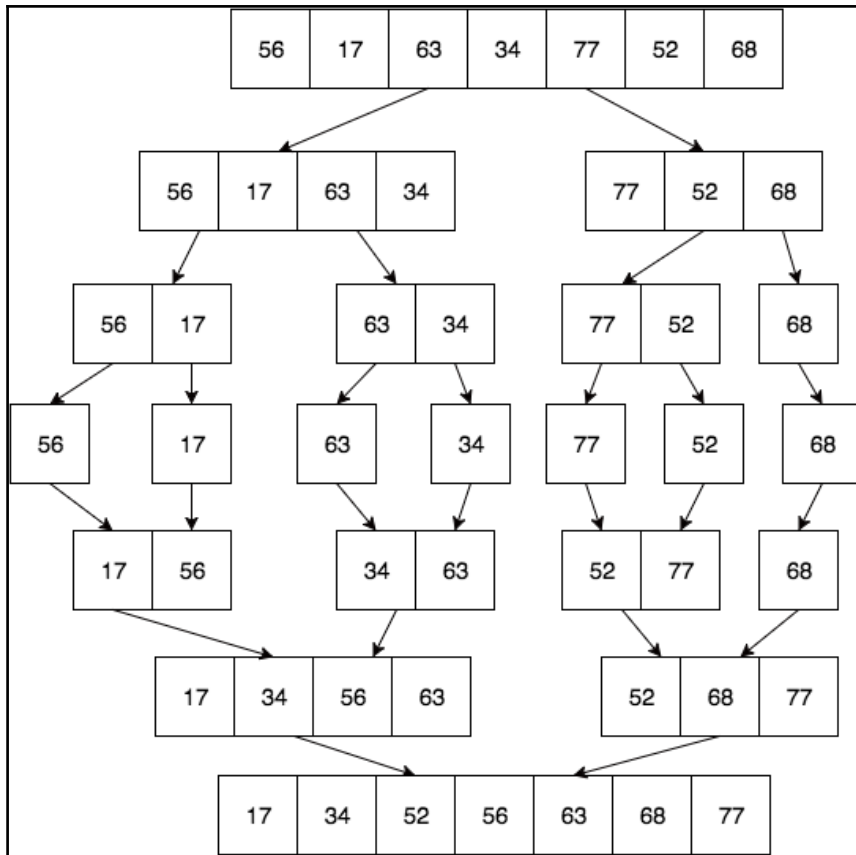

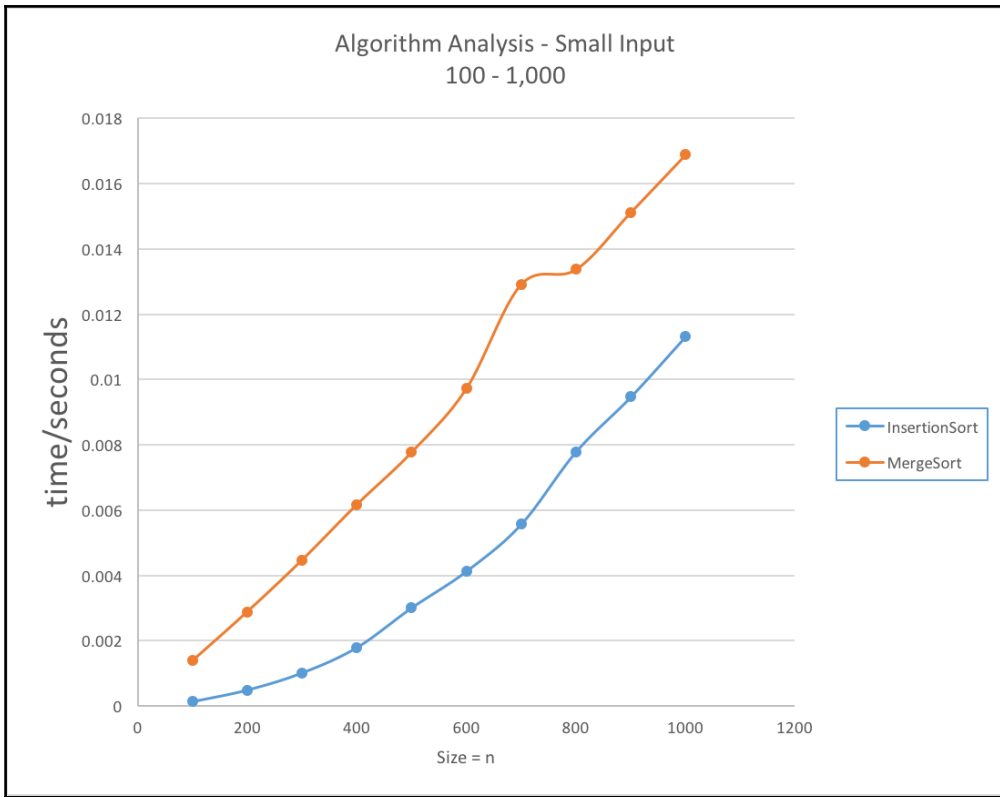

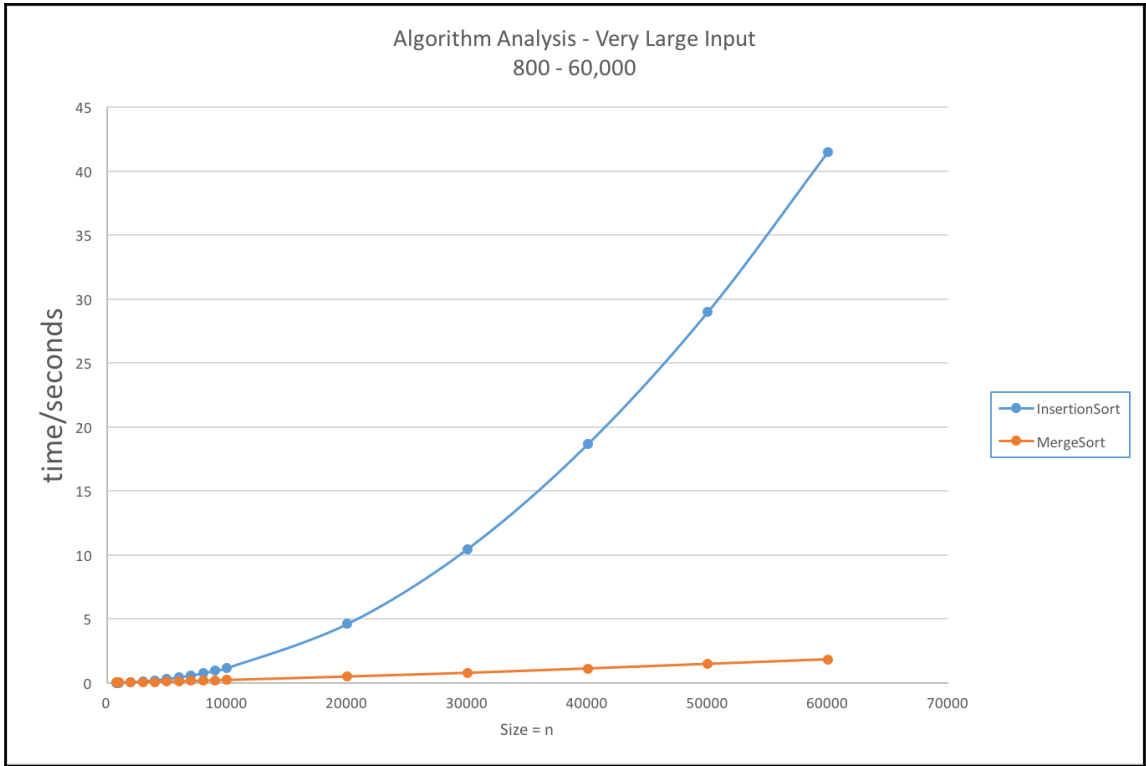

---

## Chapter 3: Standing on the Shoulders of Giants

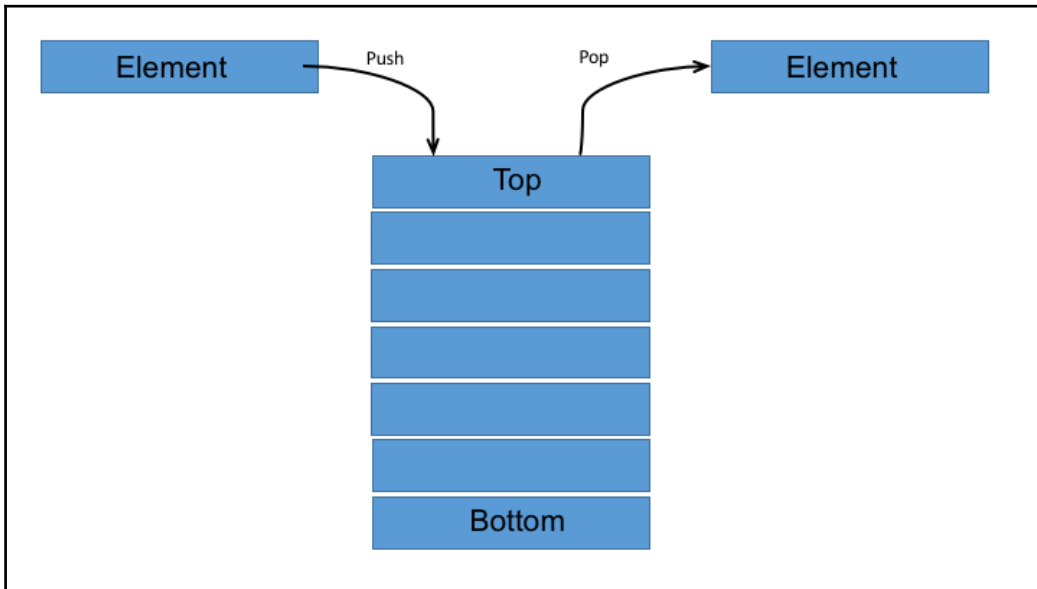

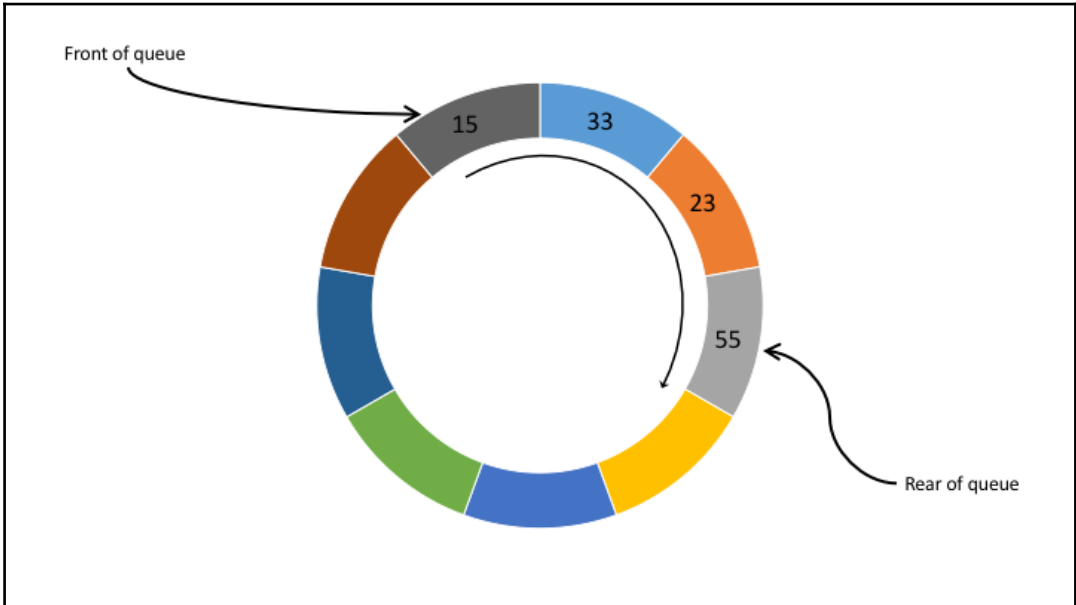
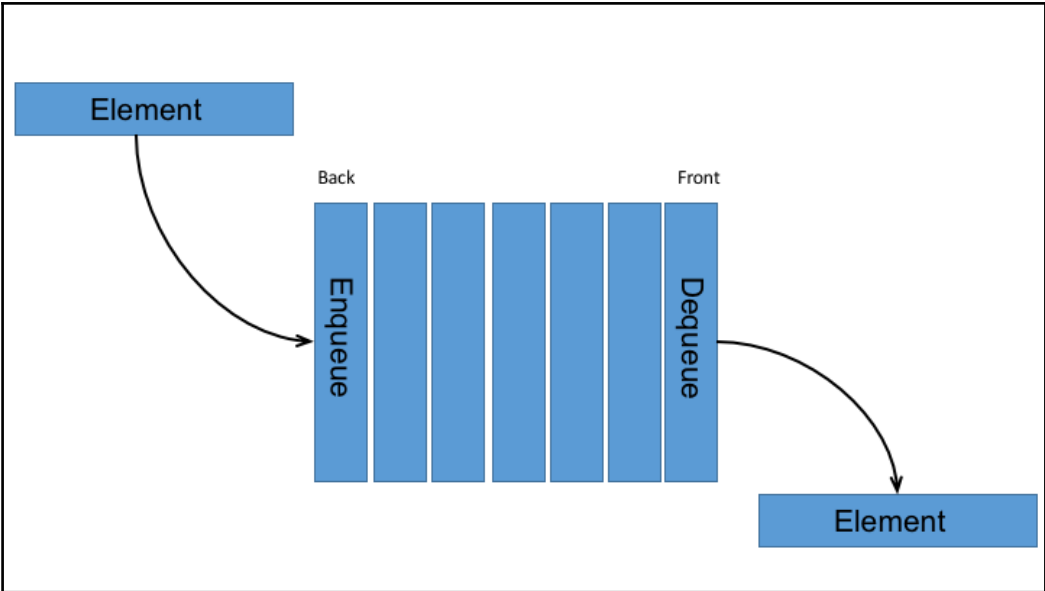



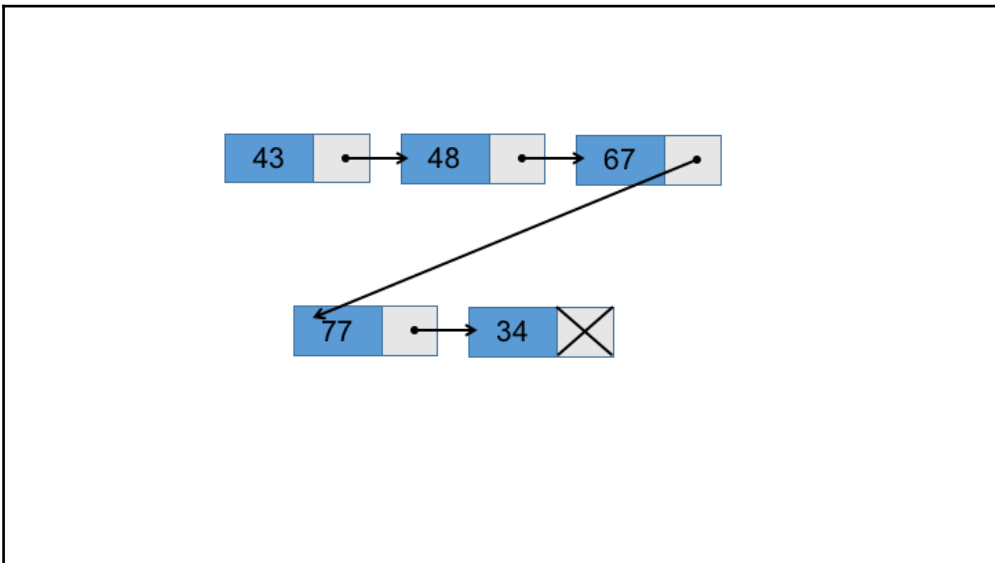
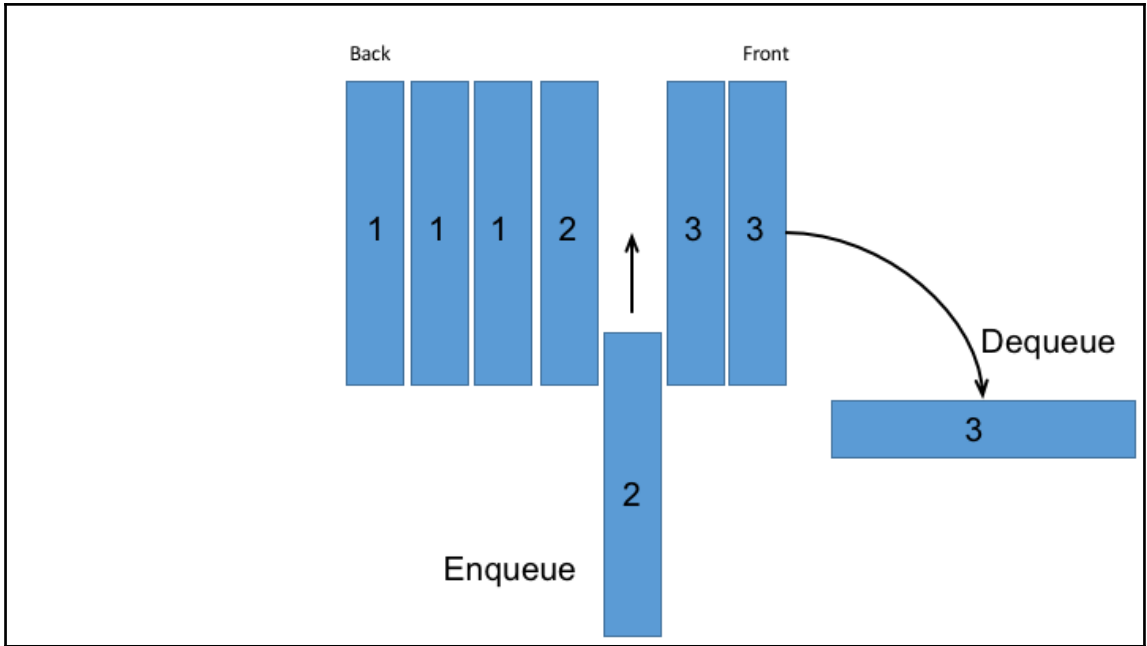

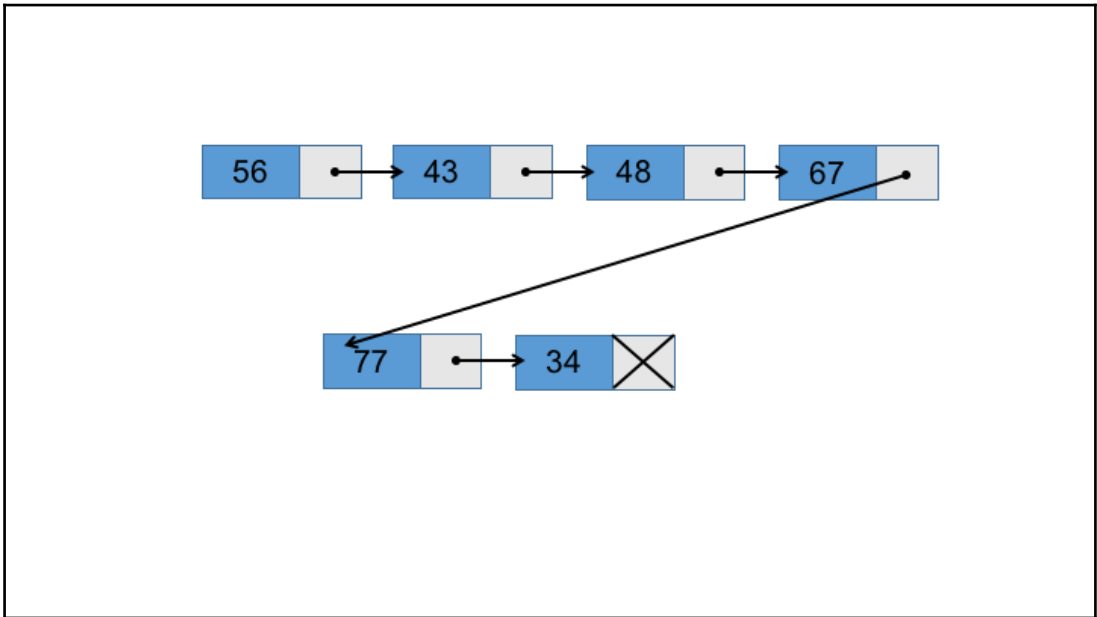
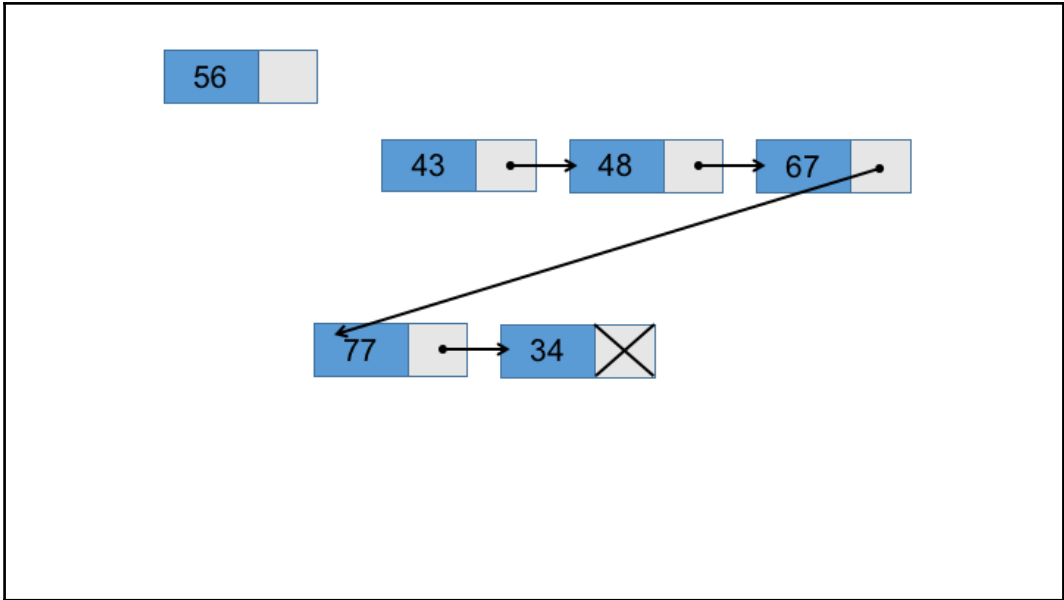

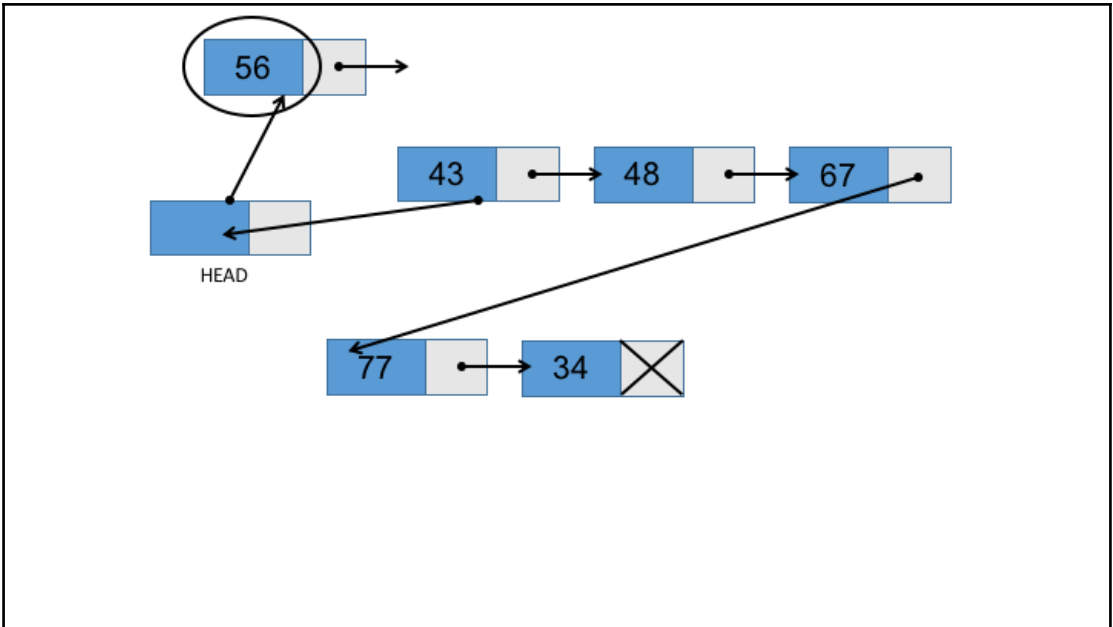

---

## Chapter 4: Sorting Algorithms

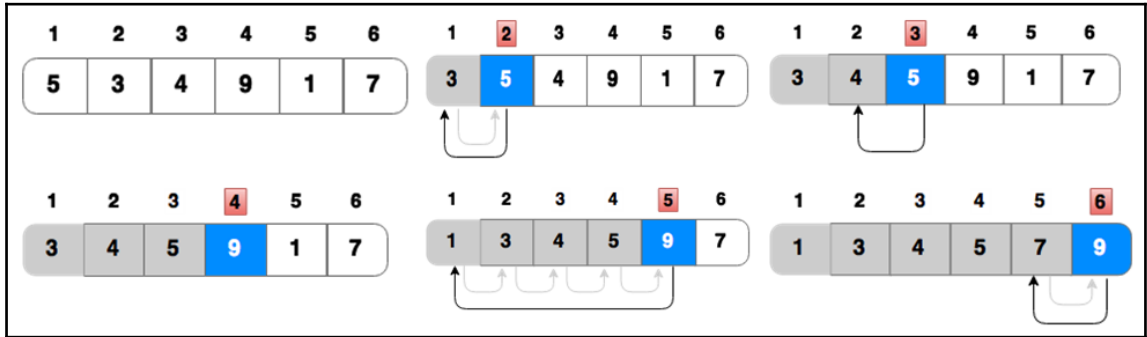

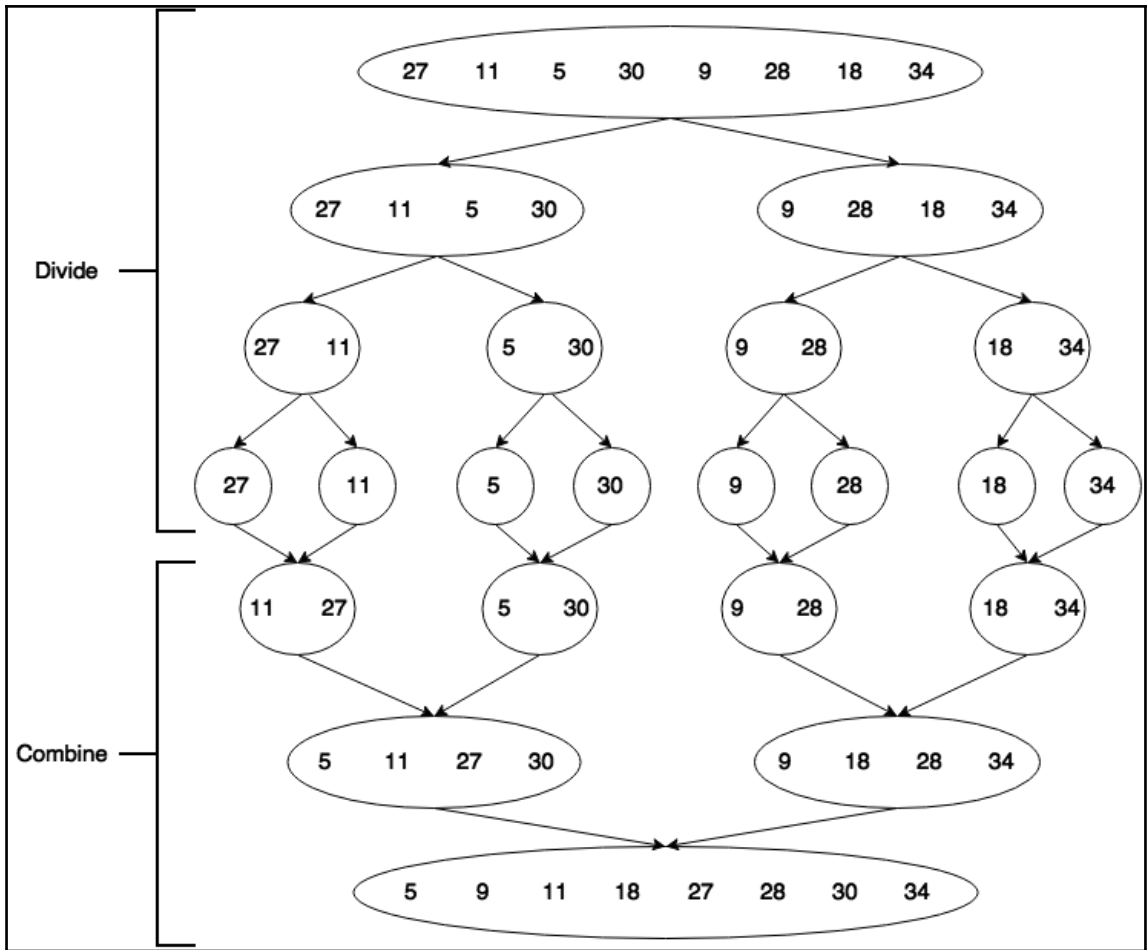

---

# Chapter 5: Seeing the Forest through the Tree

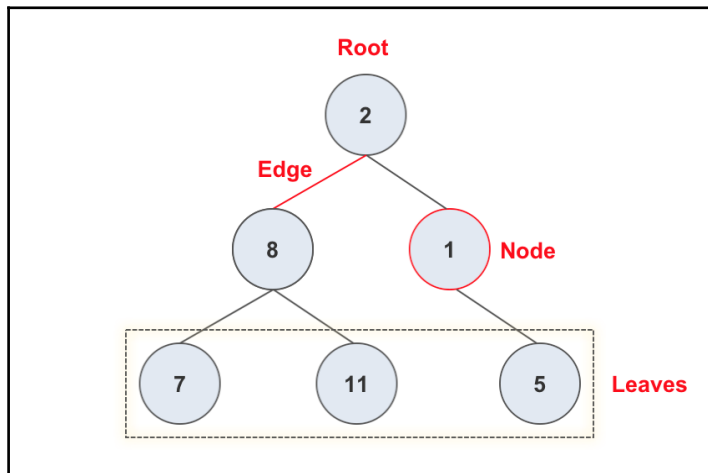
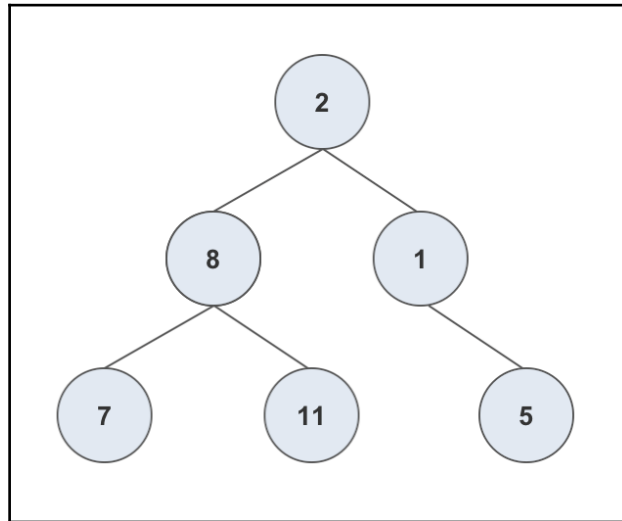

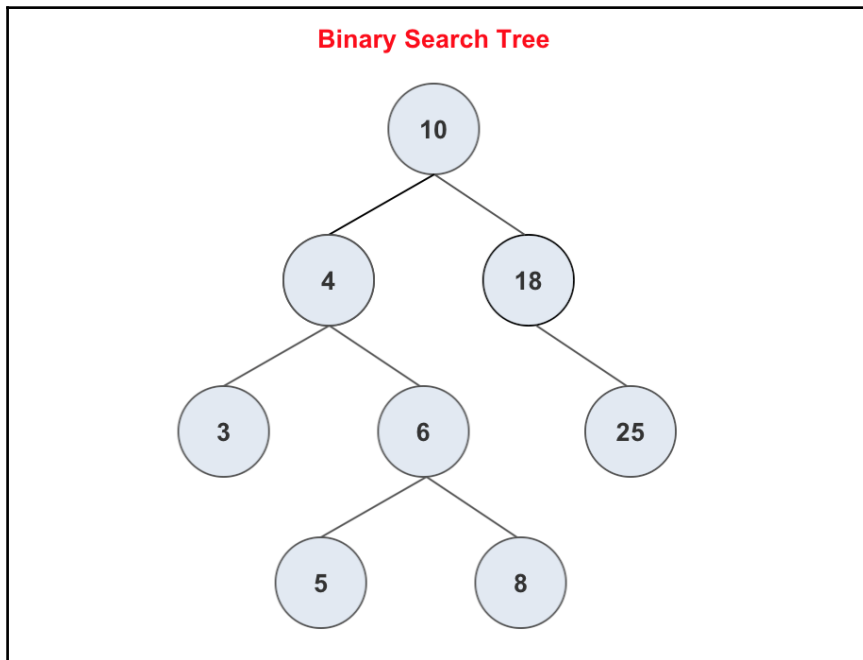
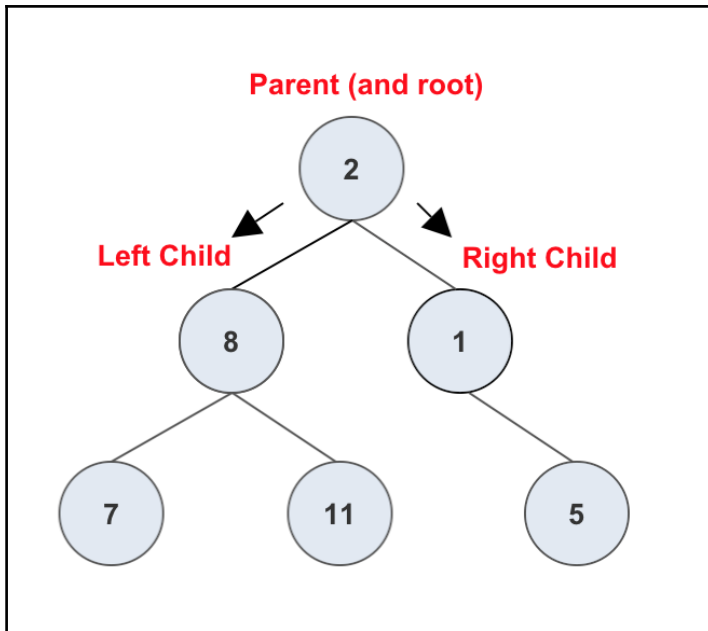

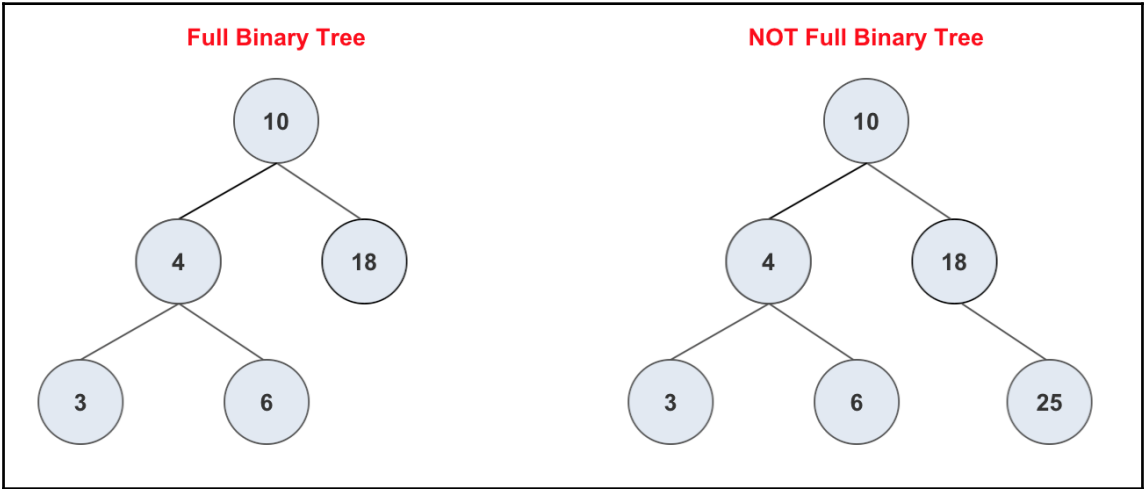
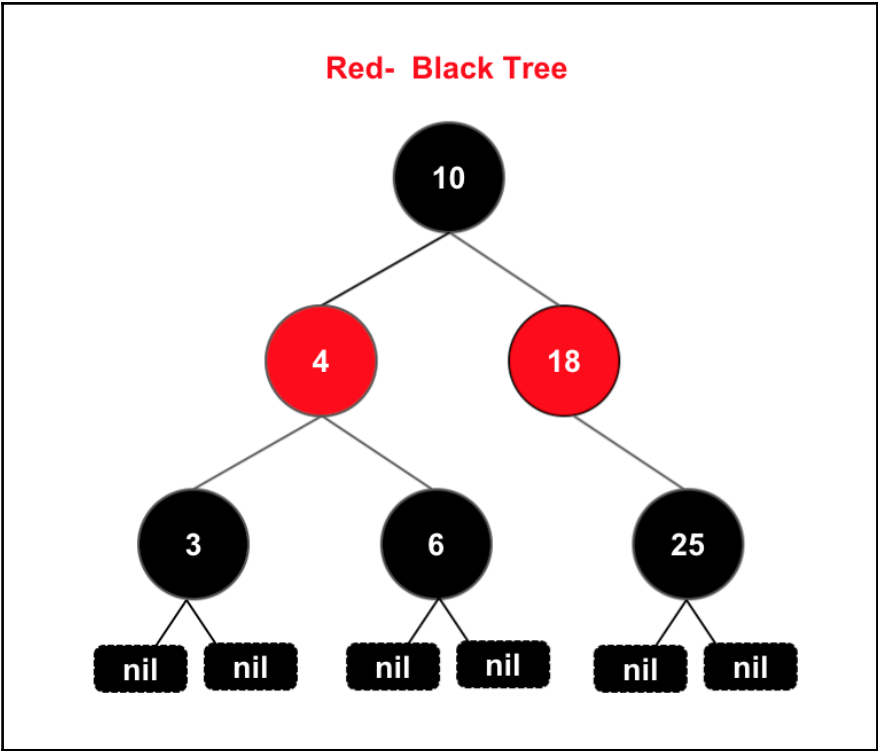



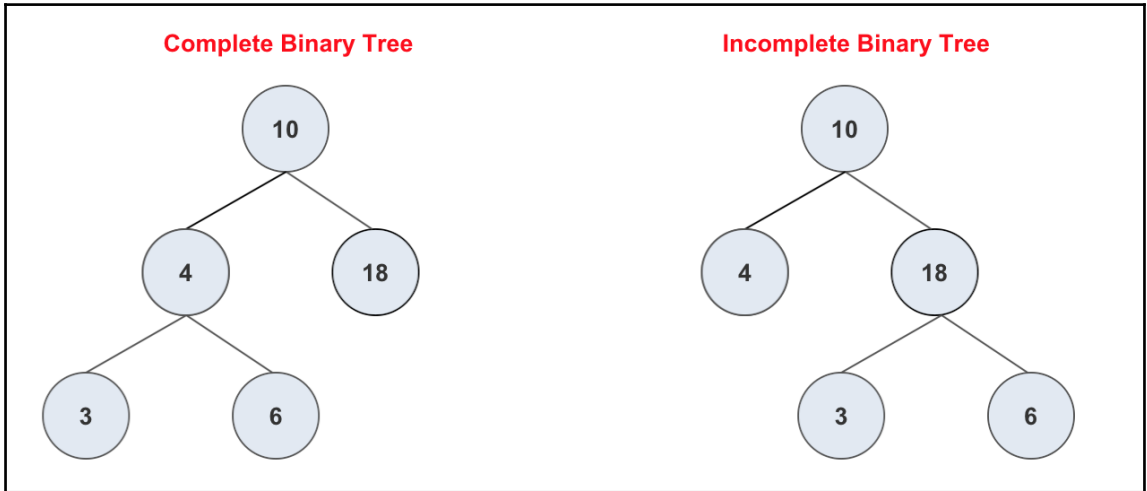
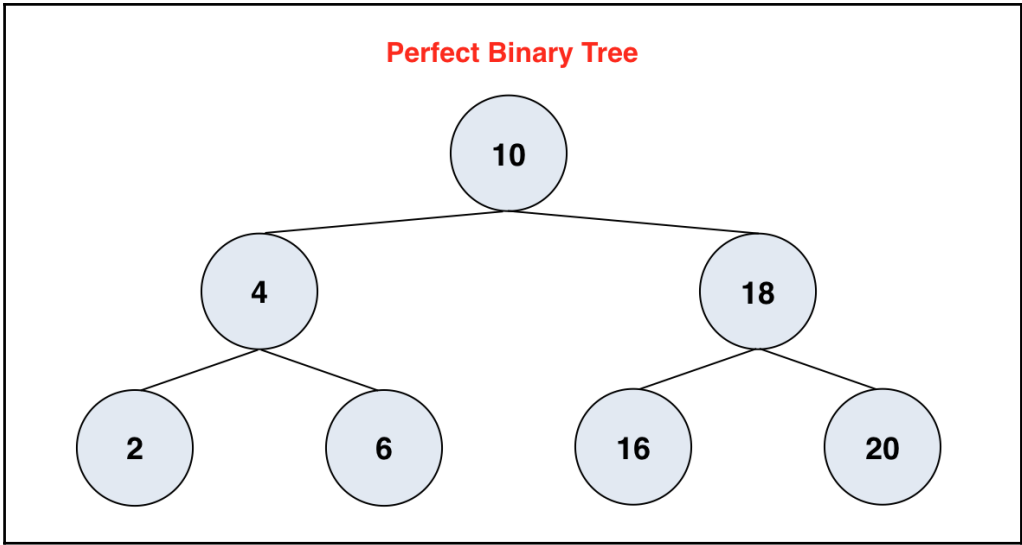

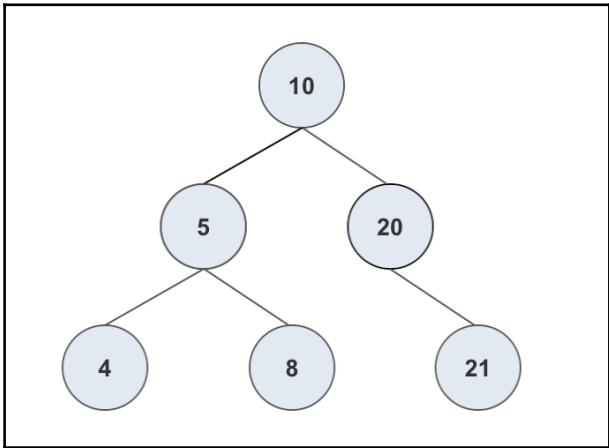
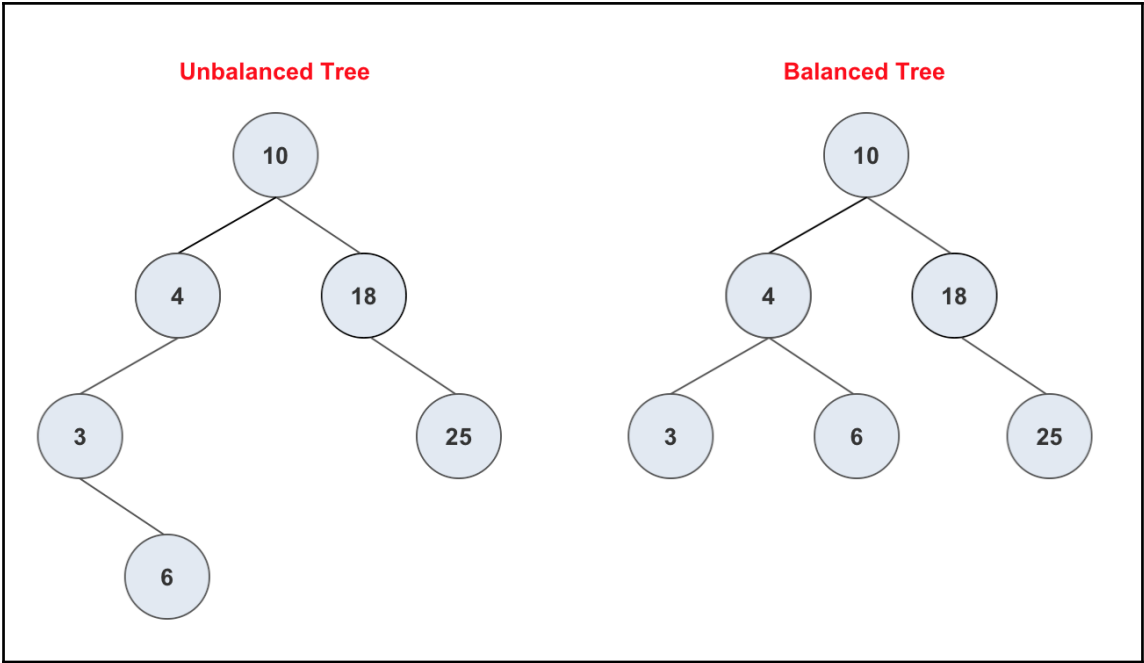

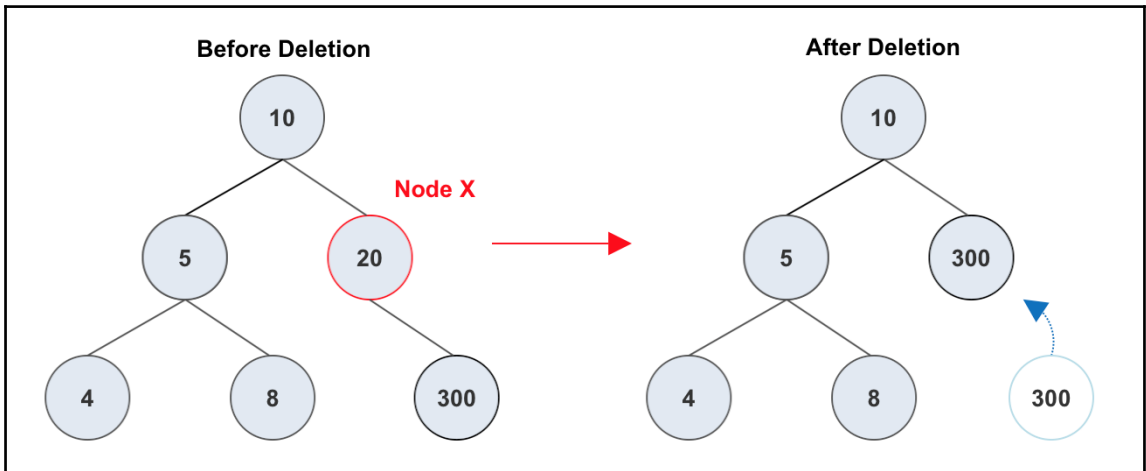
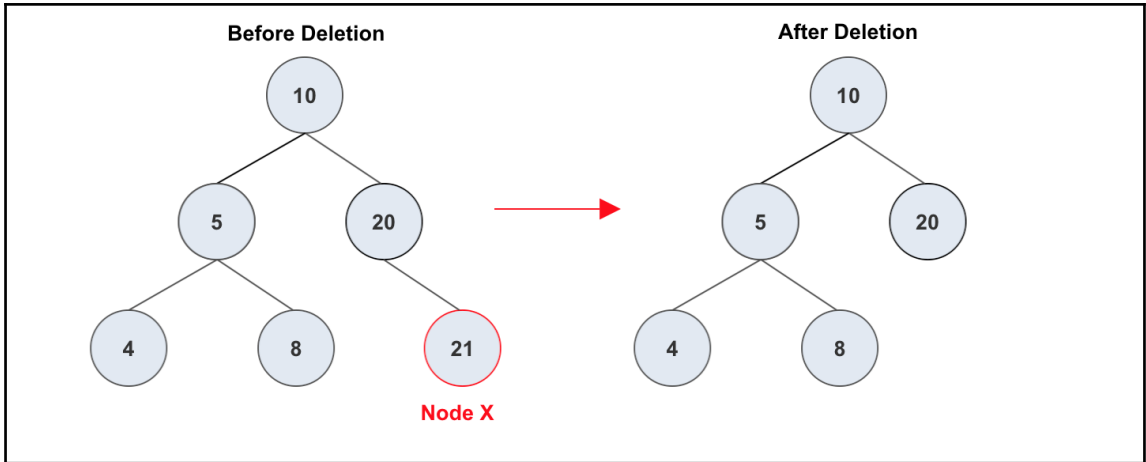

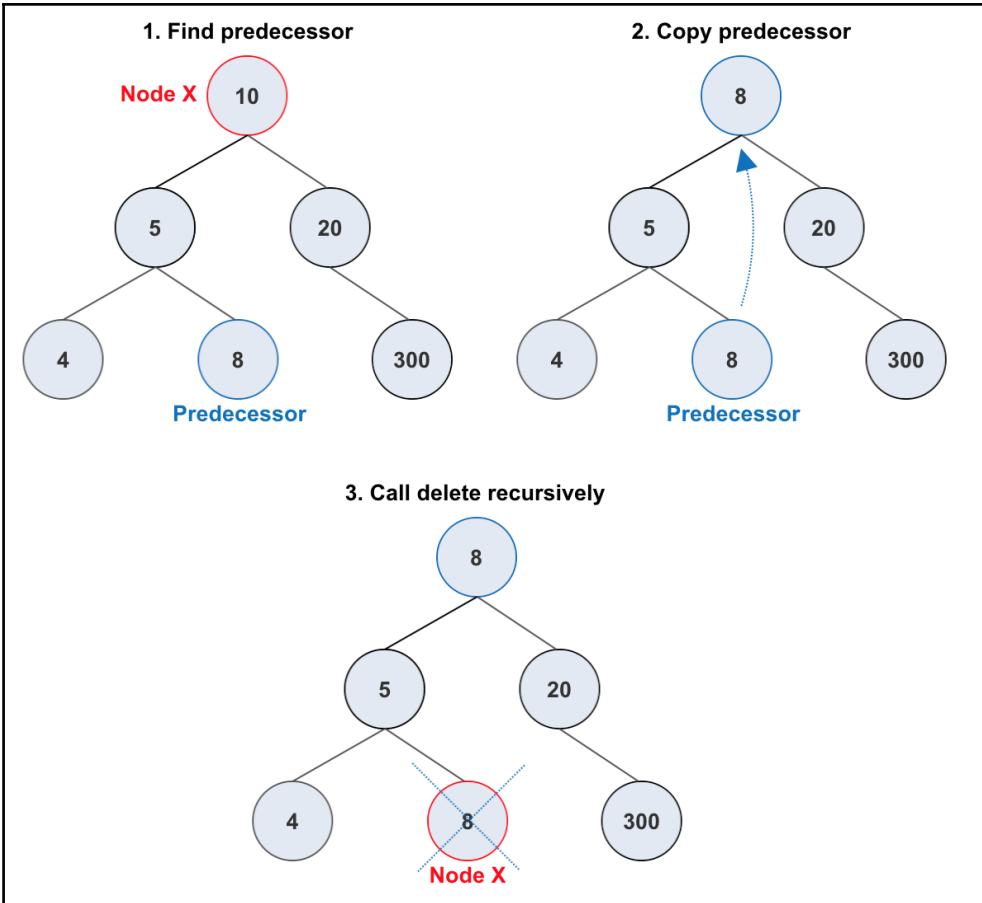

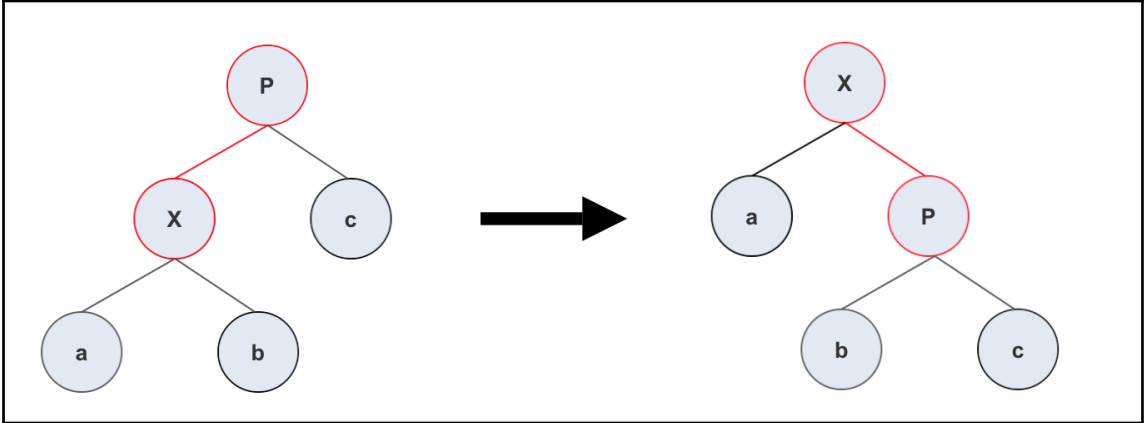
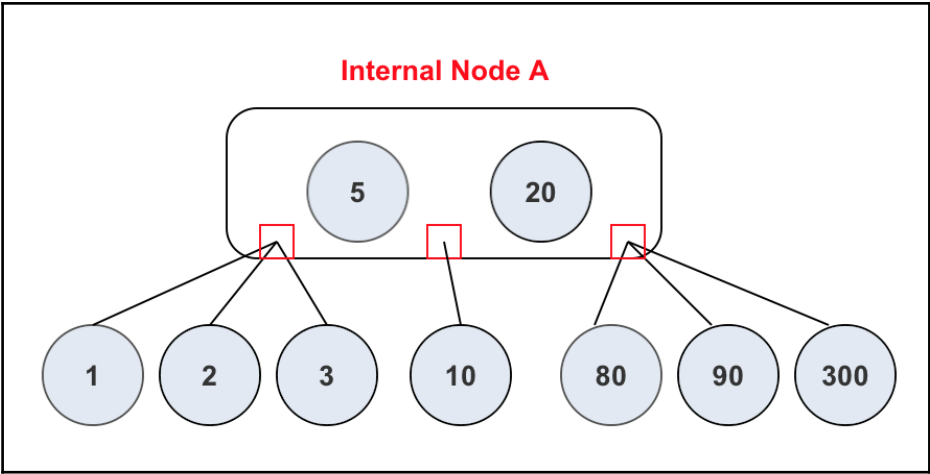

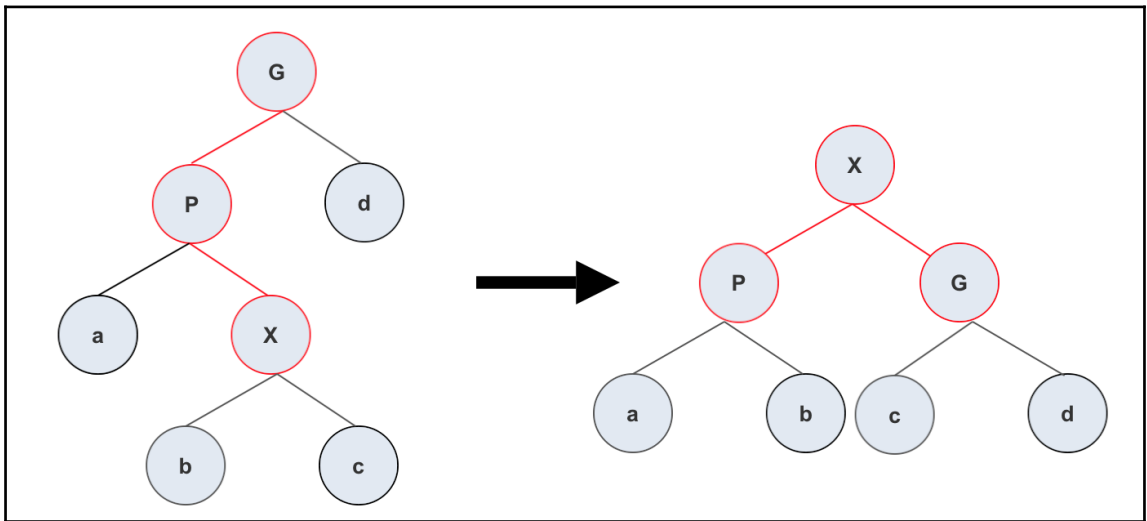
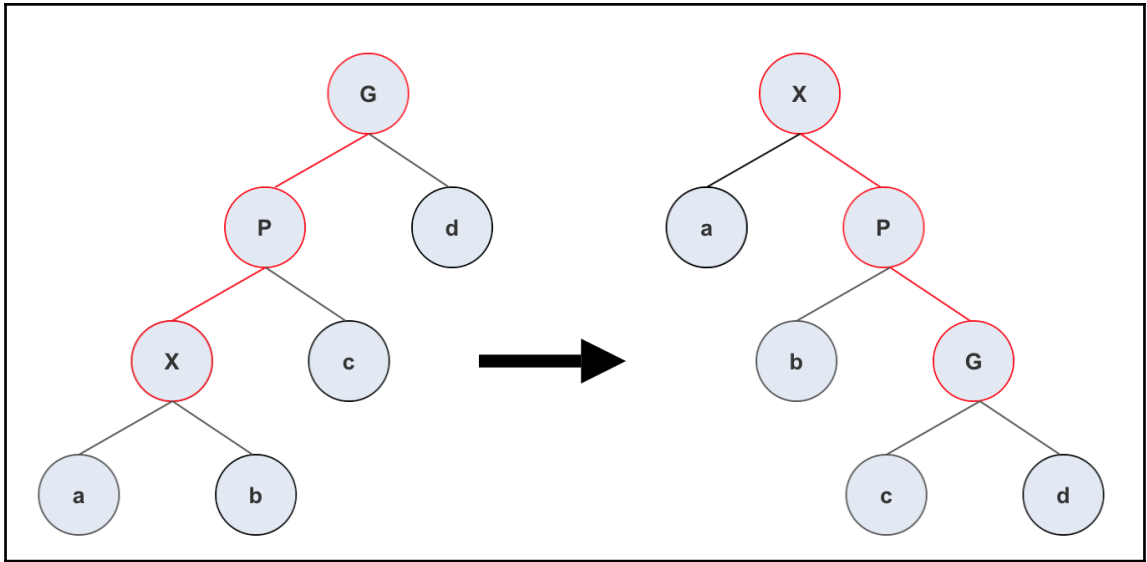

---

## Chapter 6: Advanced Searching Methods

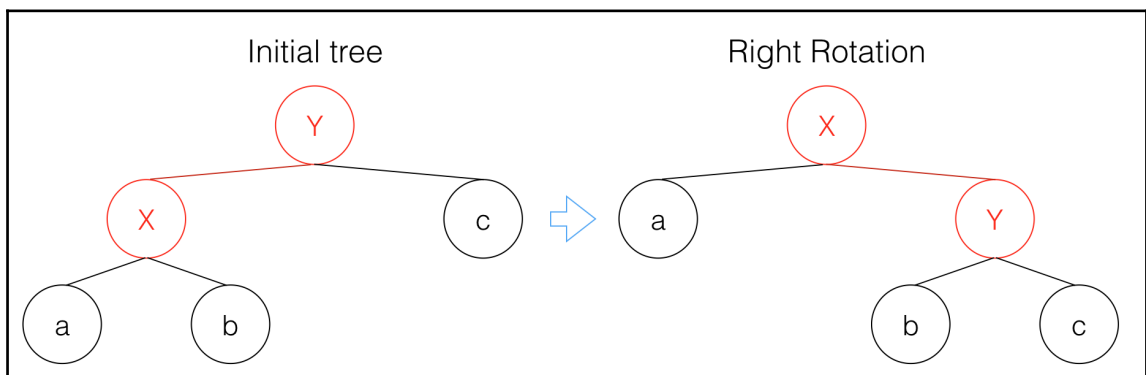
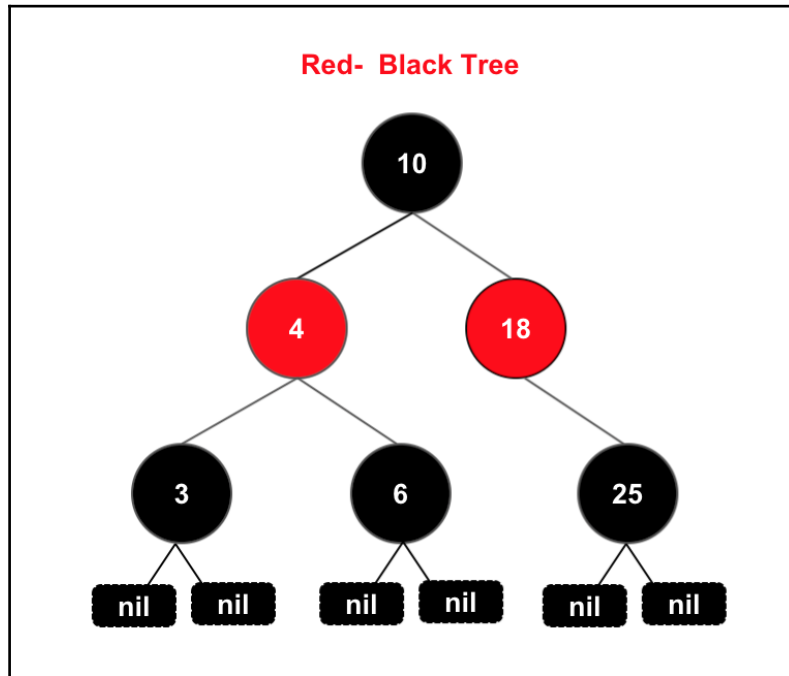

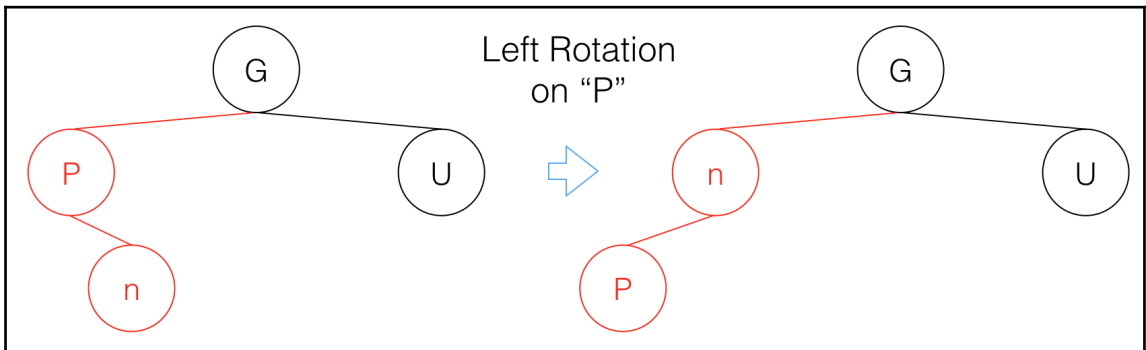
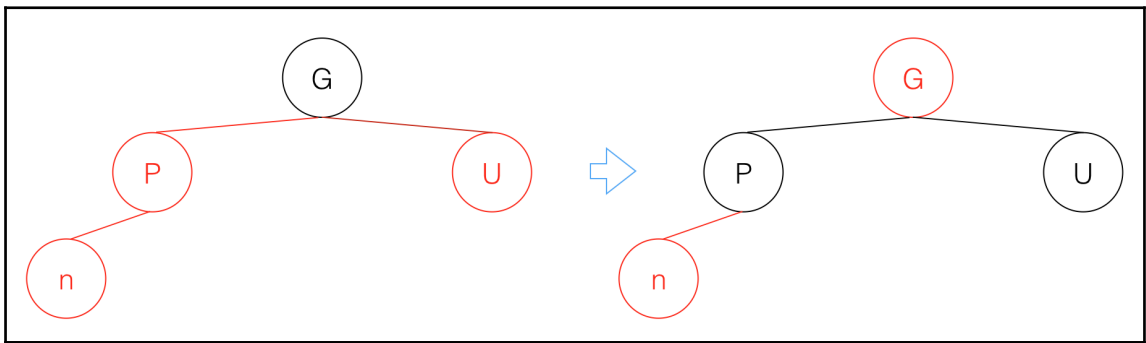
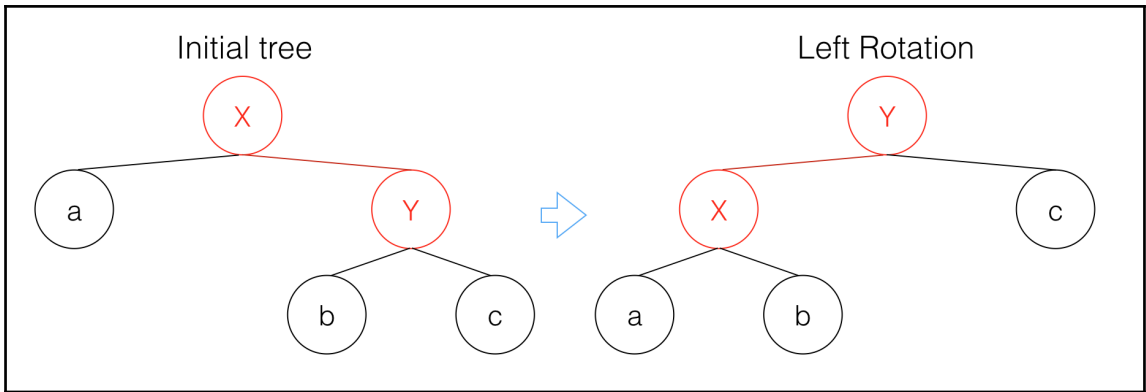



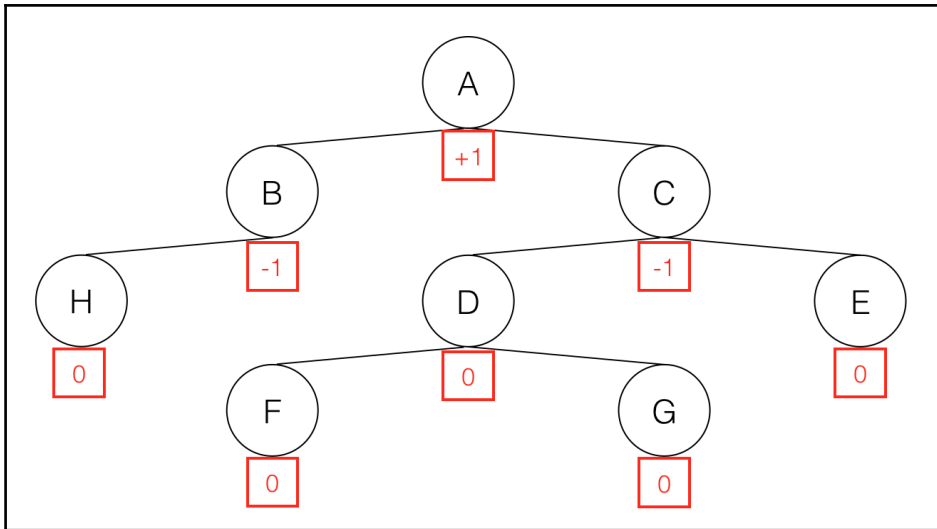
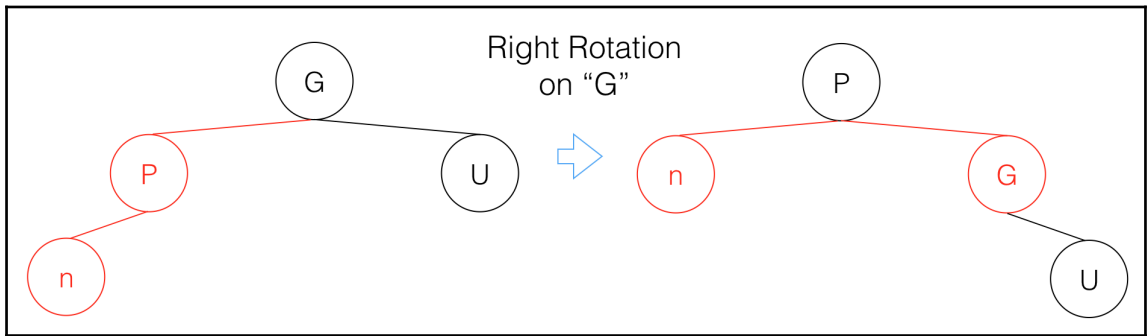
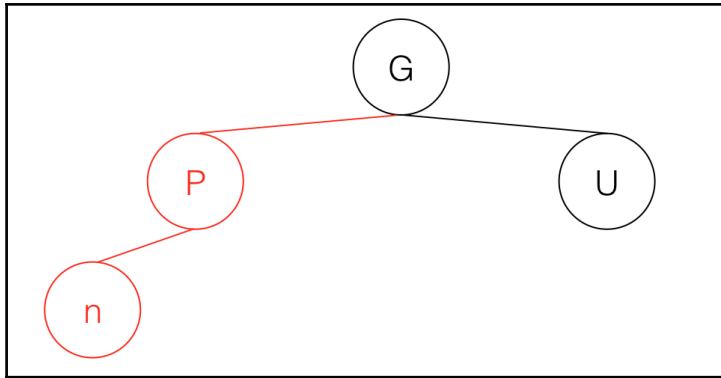

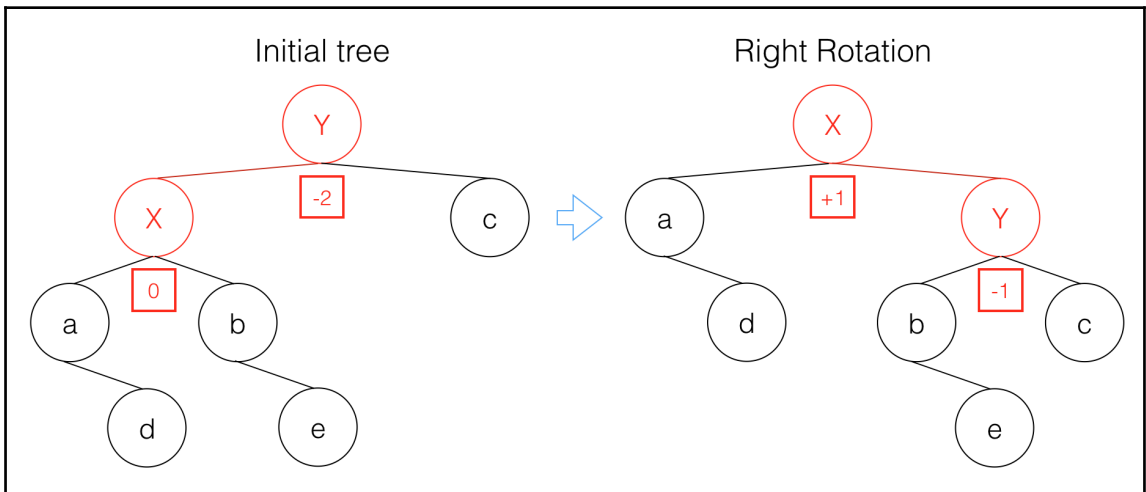
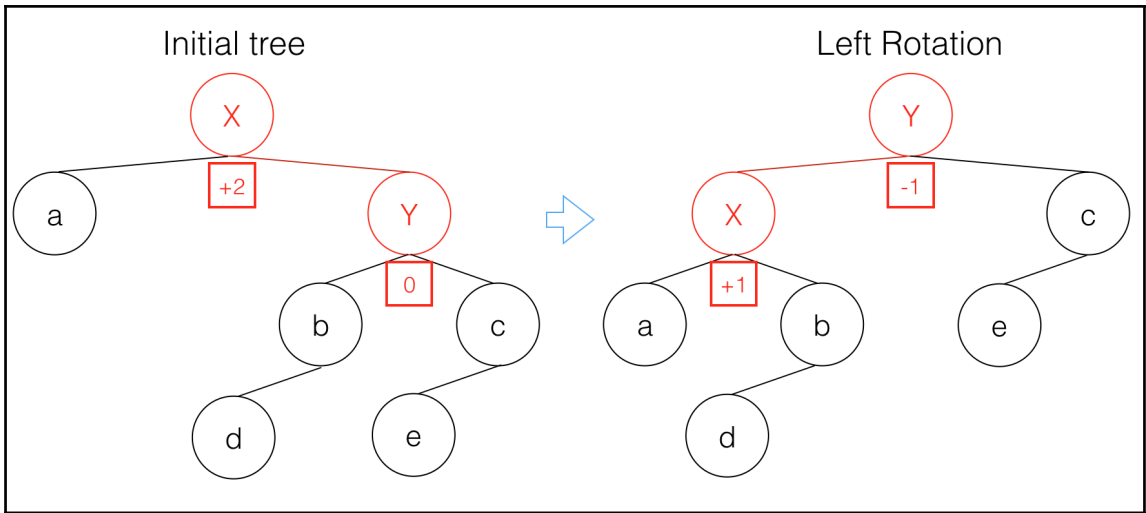

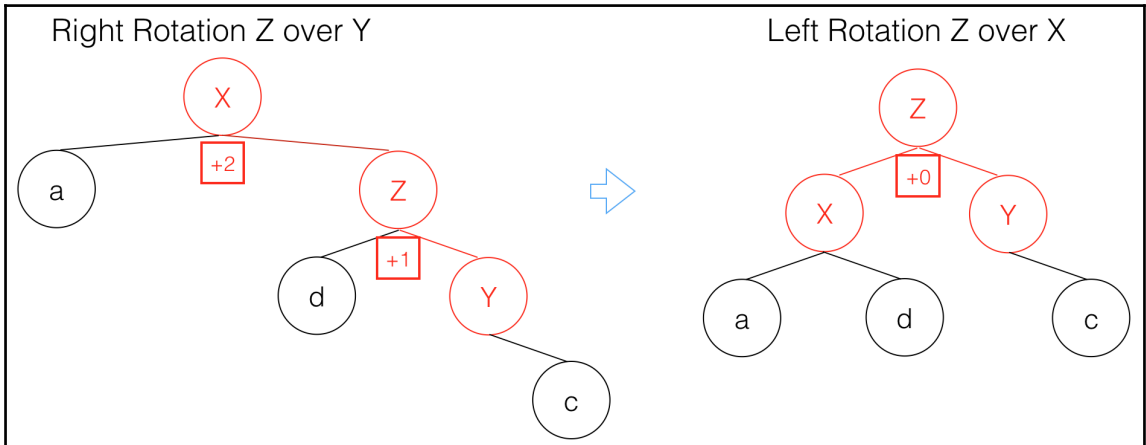
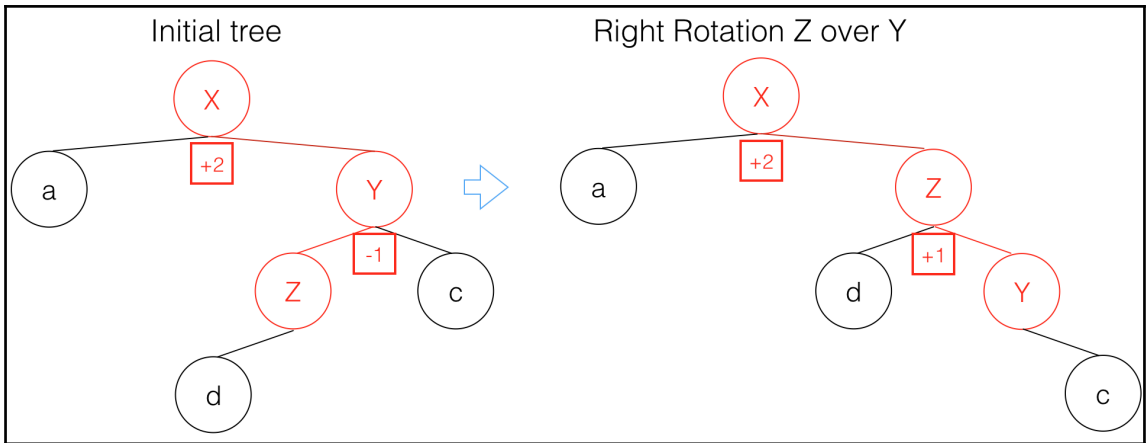

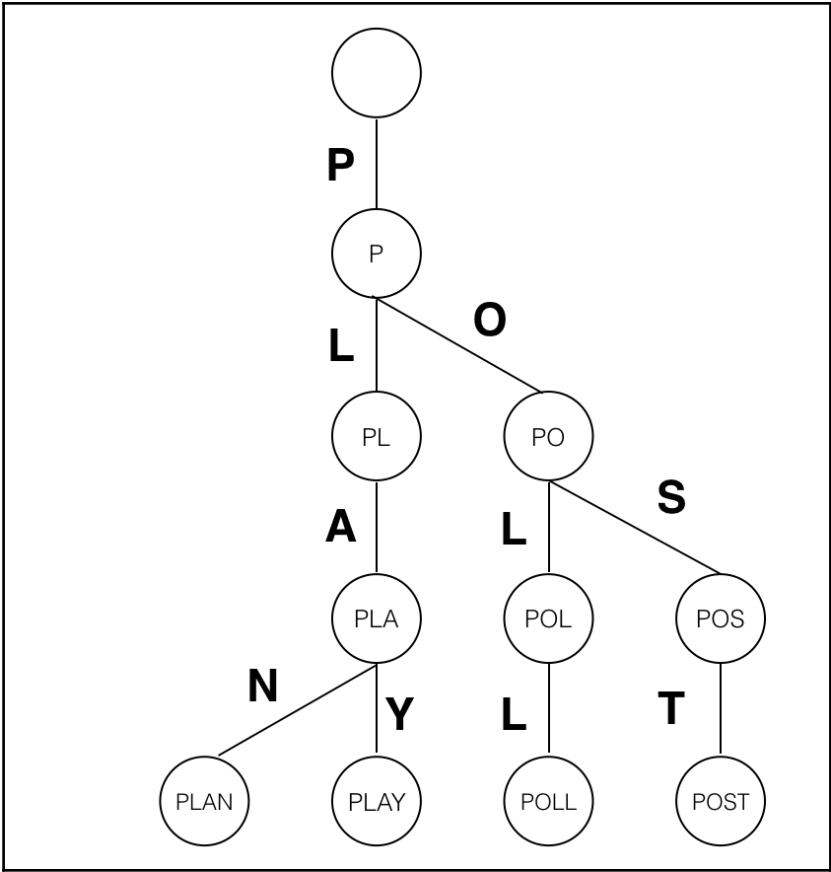

Trie Tree

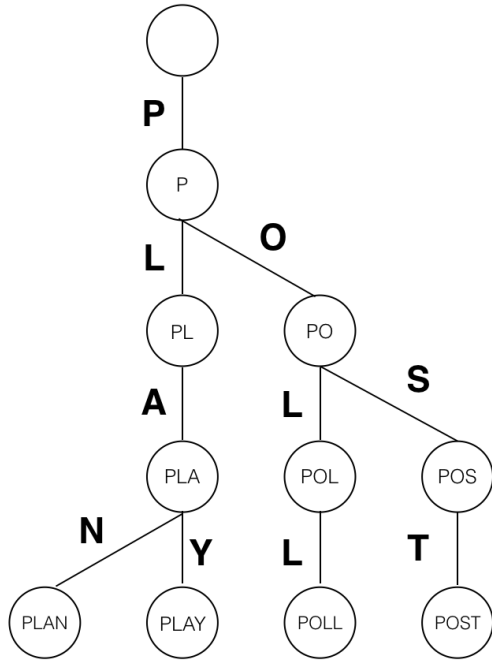

Radix Tree

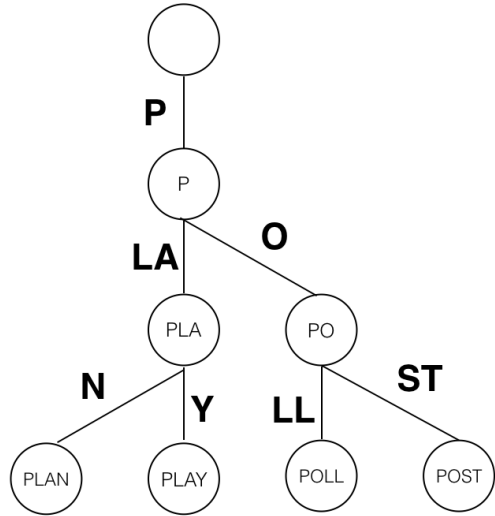

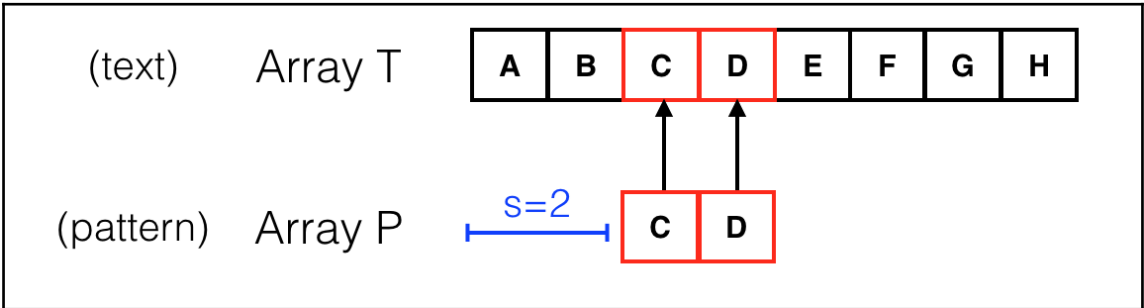
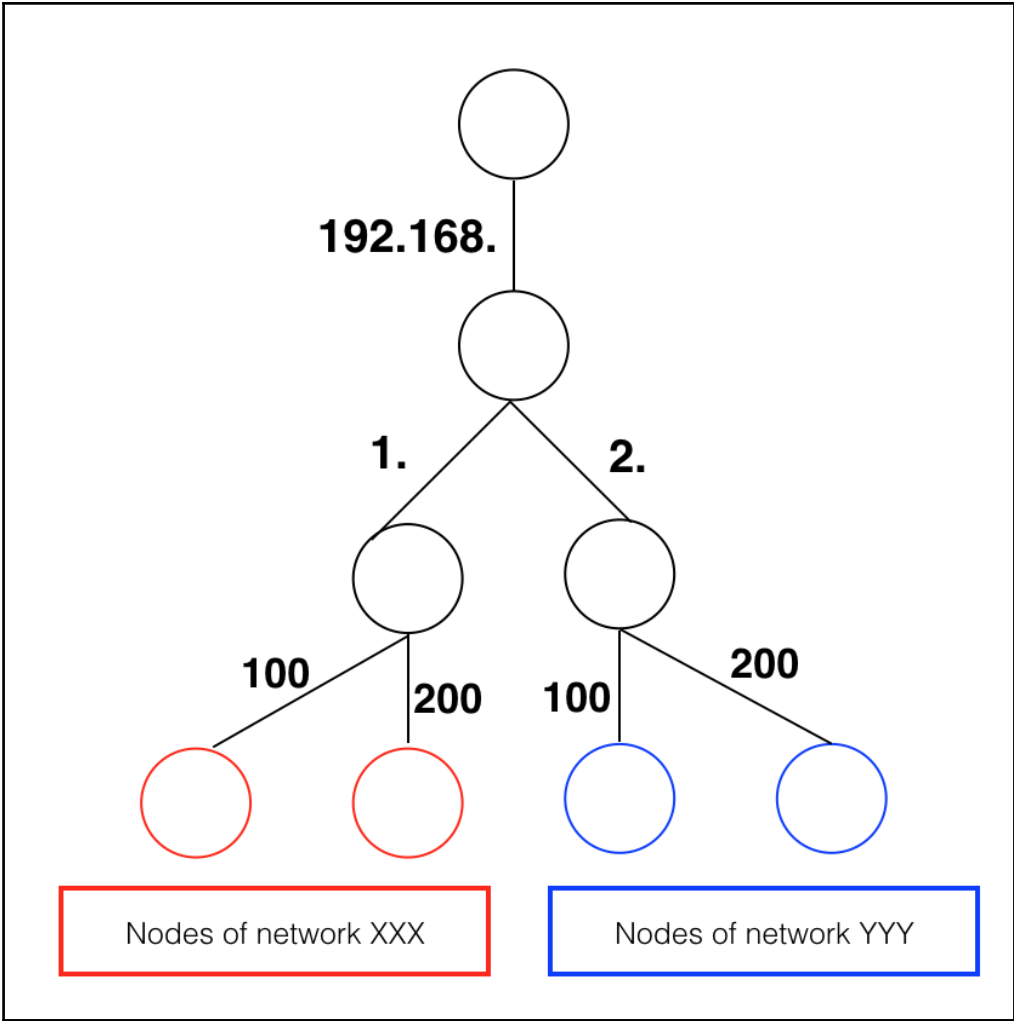

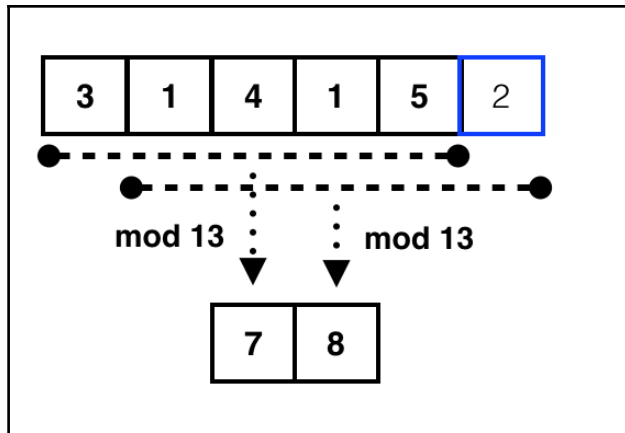
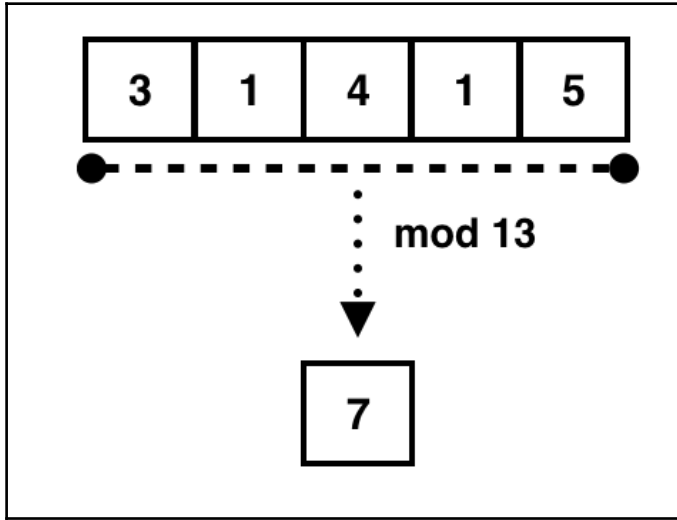
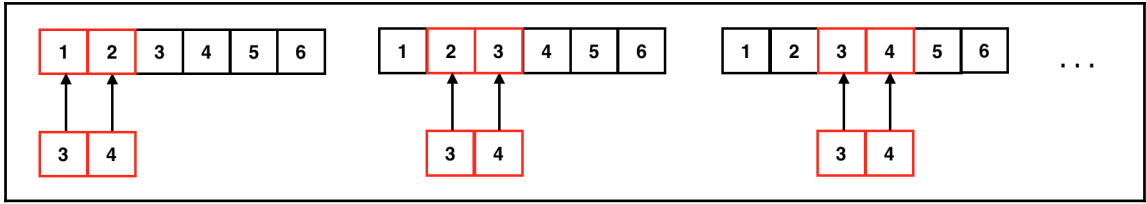

---

# Chapter 7: Graph Algorithms

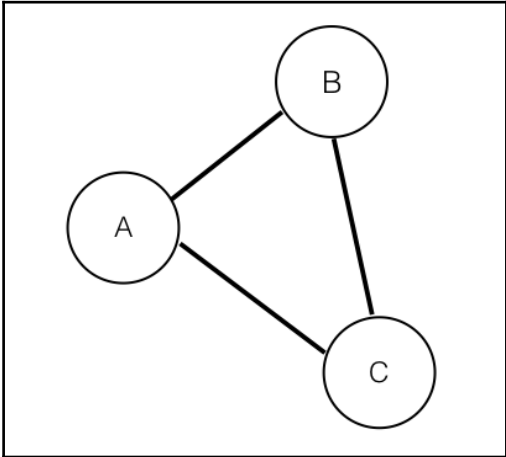
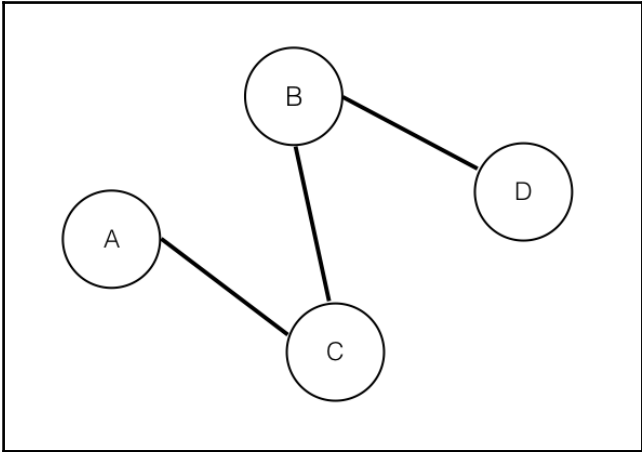



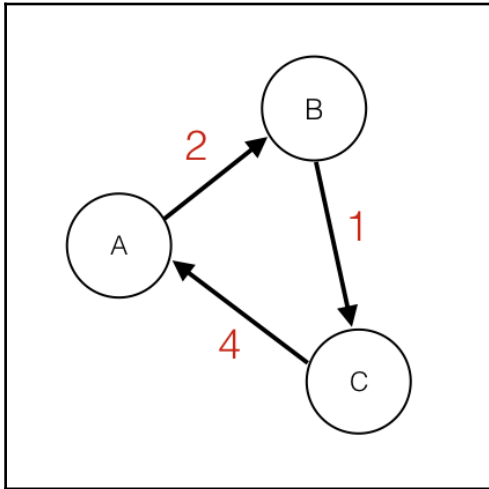
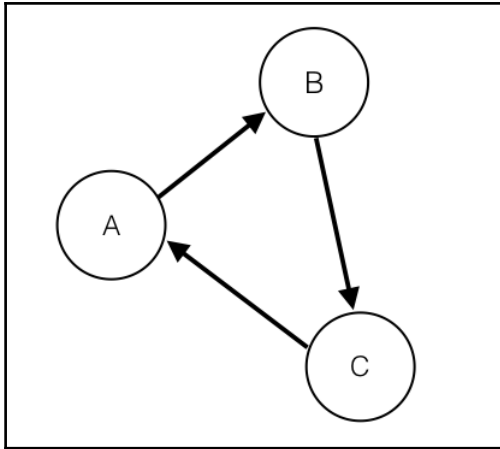

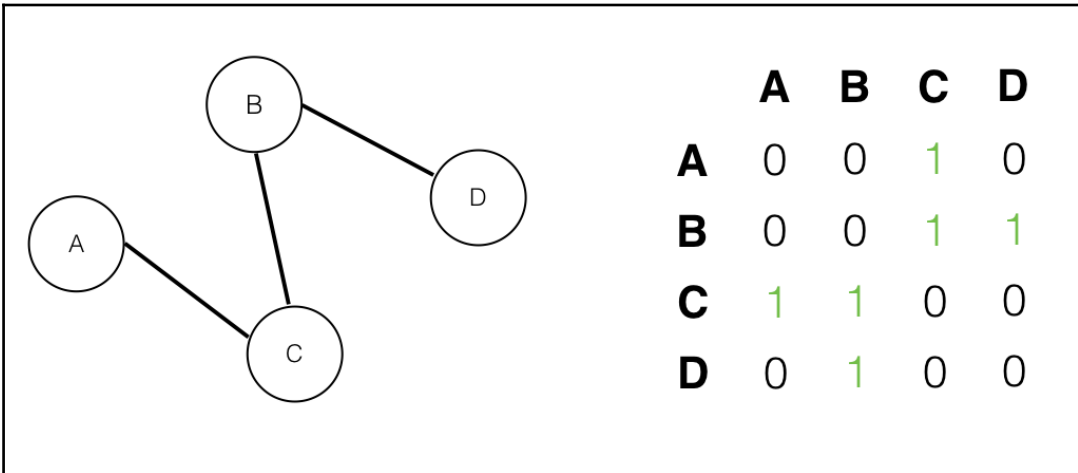
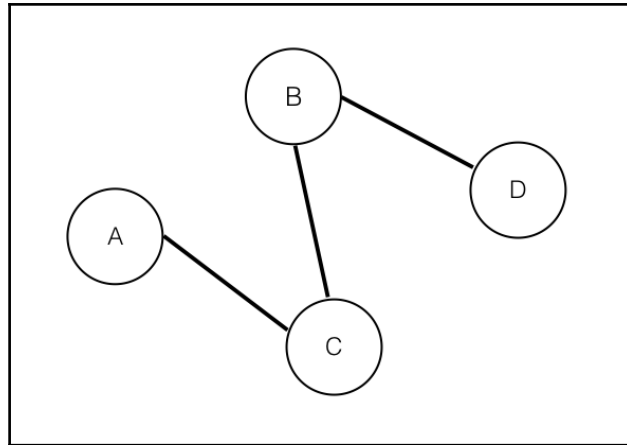

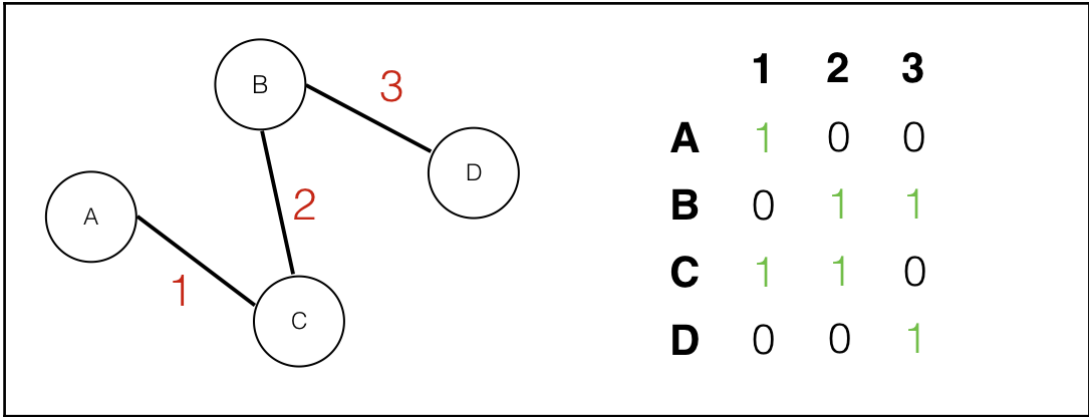

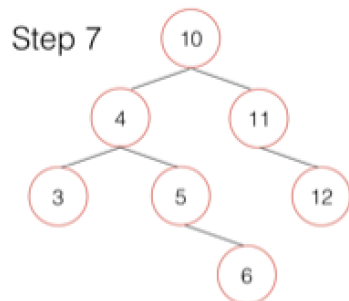
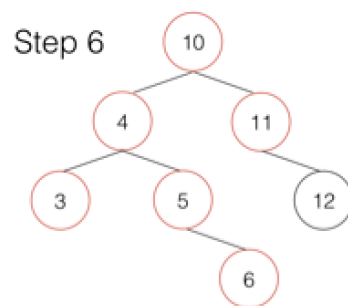
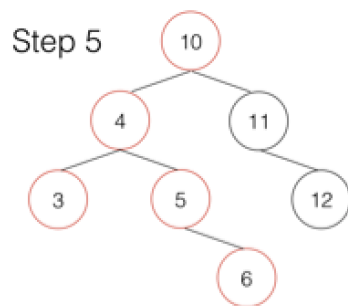
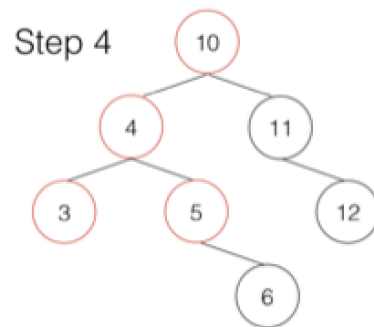
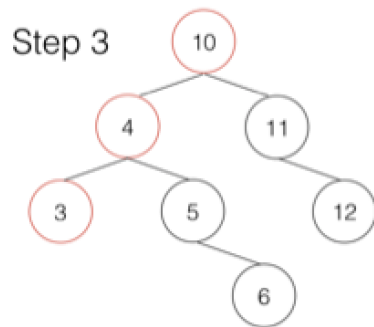
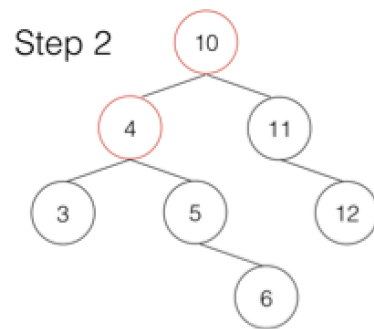
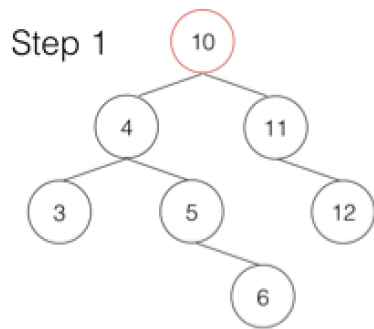

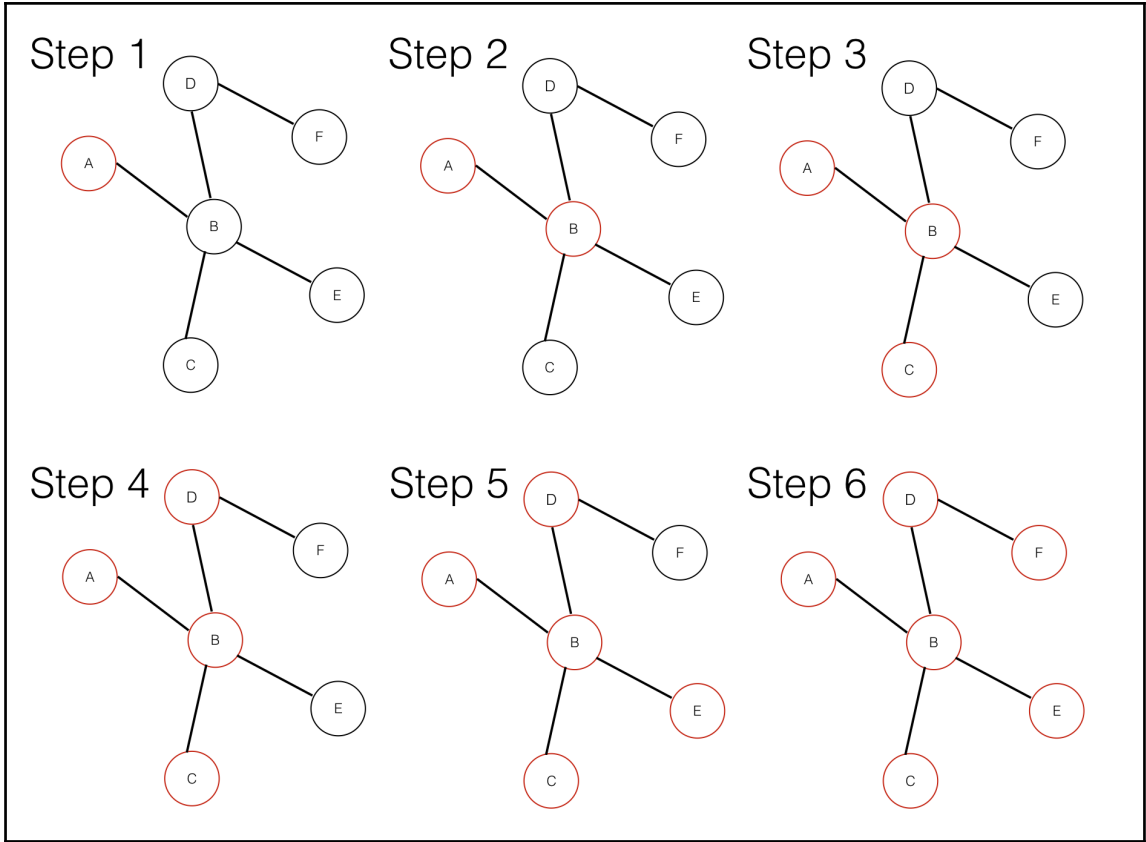

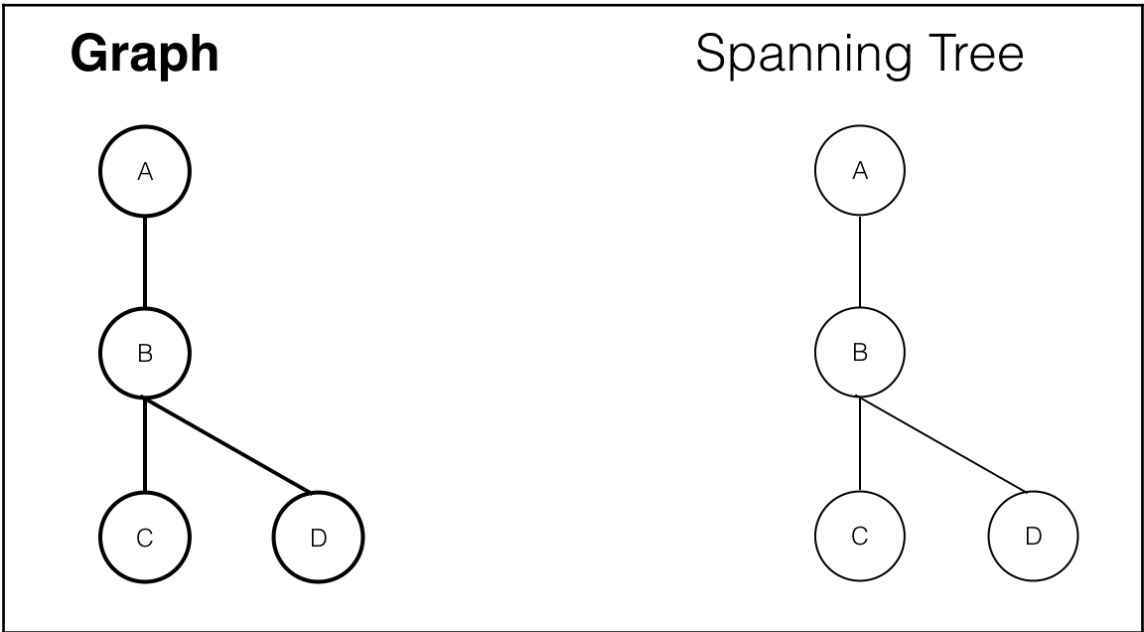
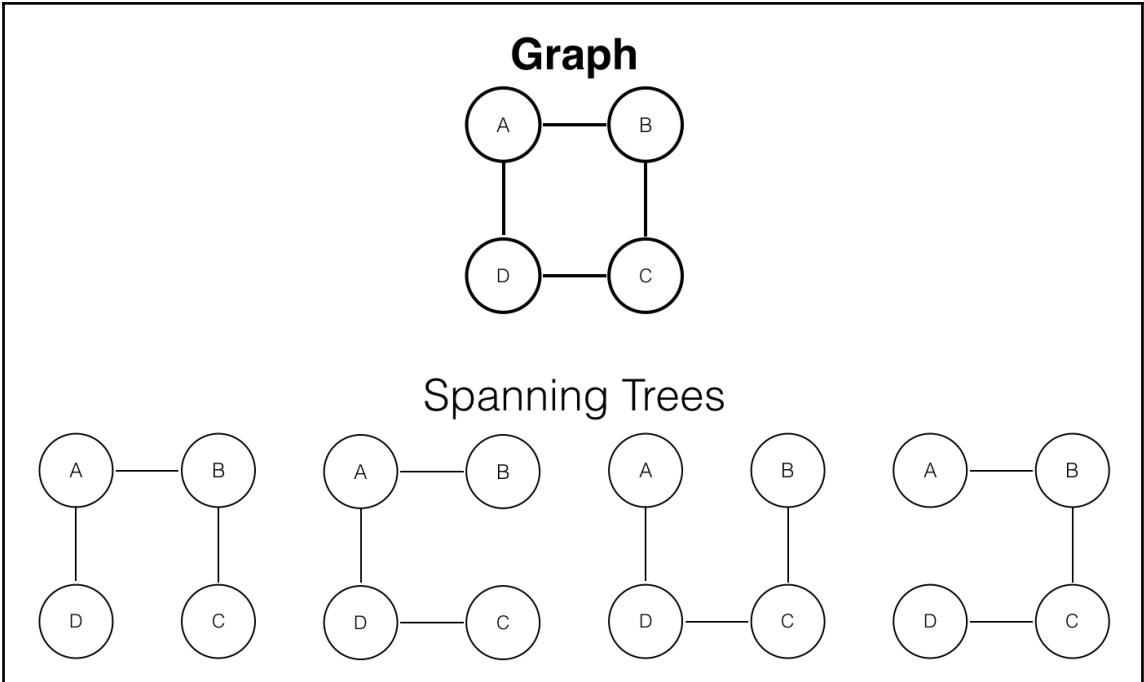

Initial Graph

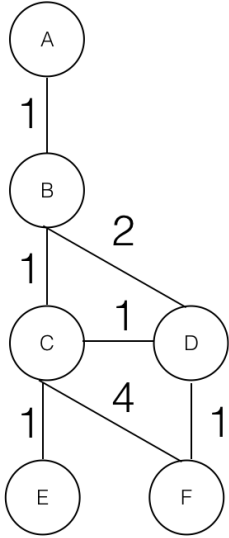

**MST = 5**

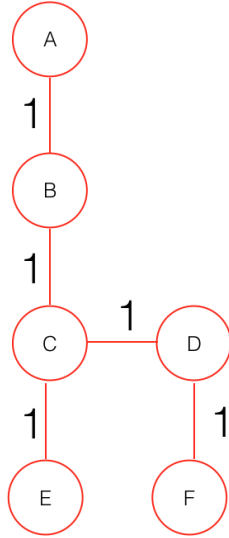

Other Spanning Tree = 6

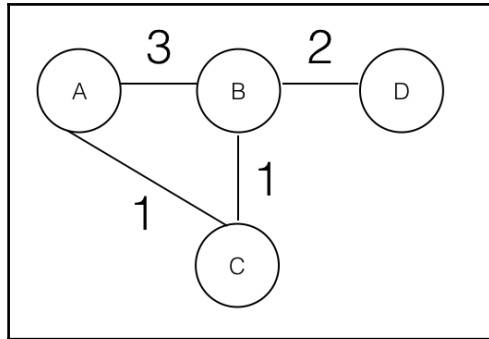
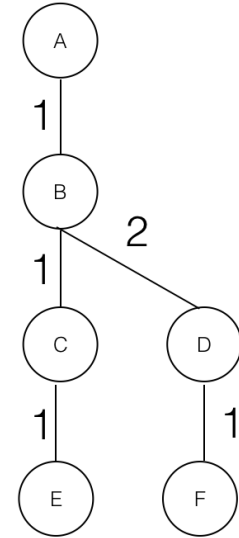

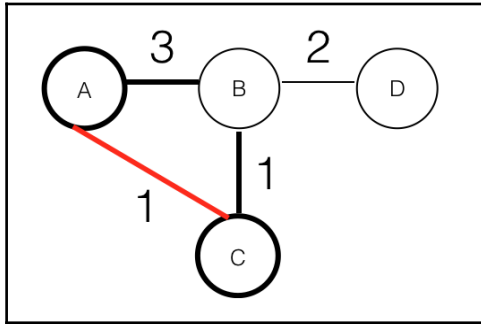
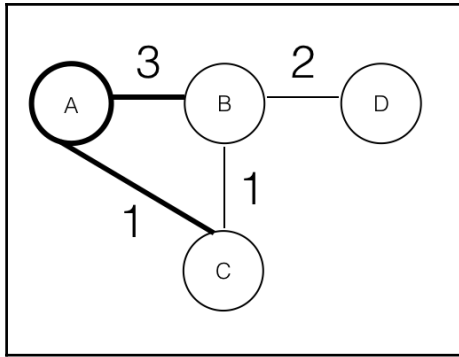



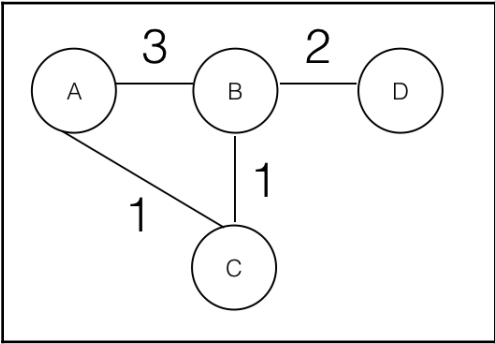
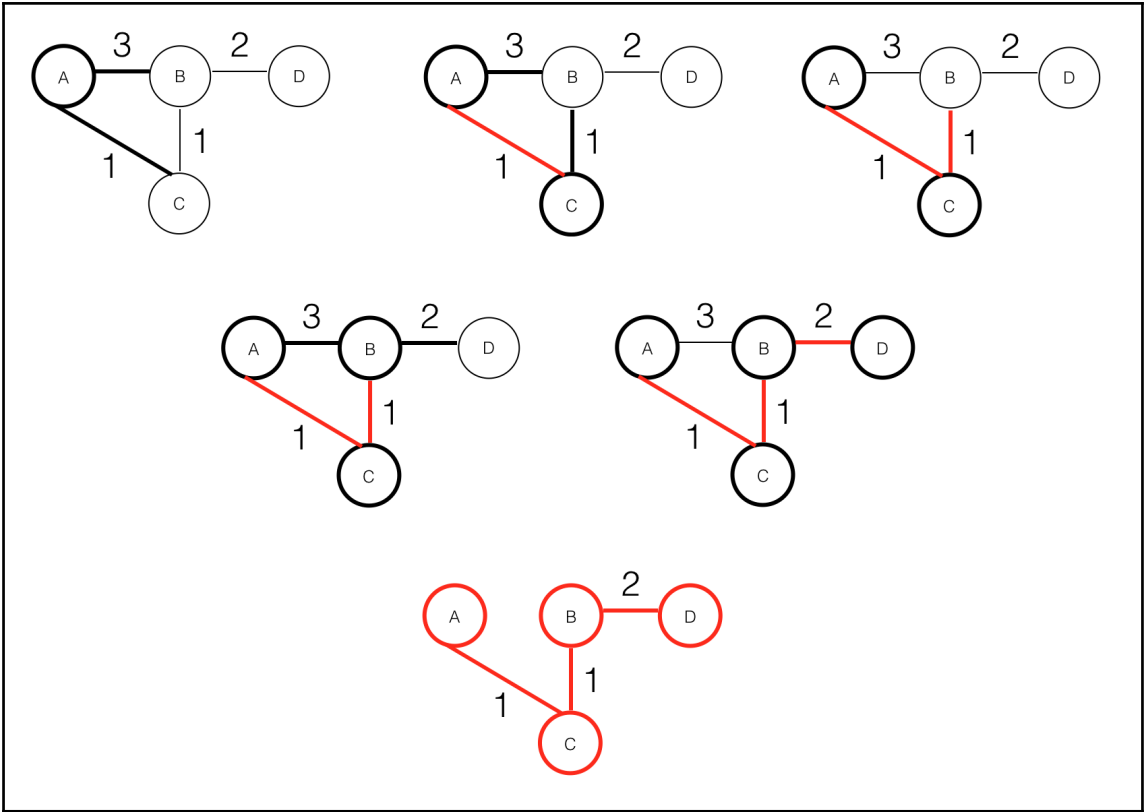

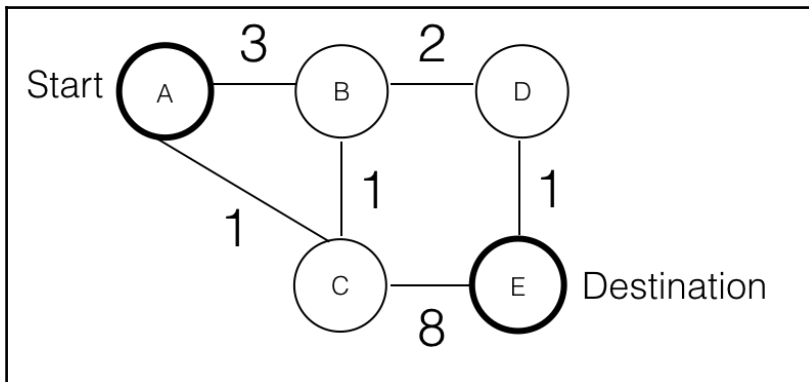
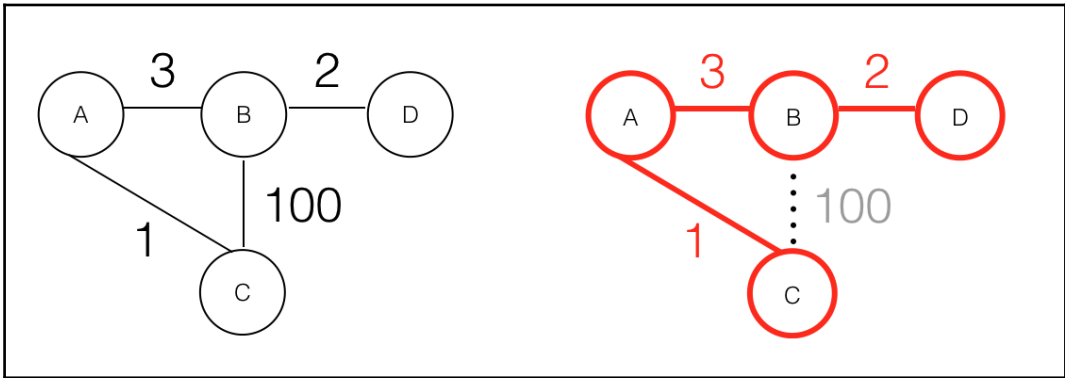
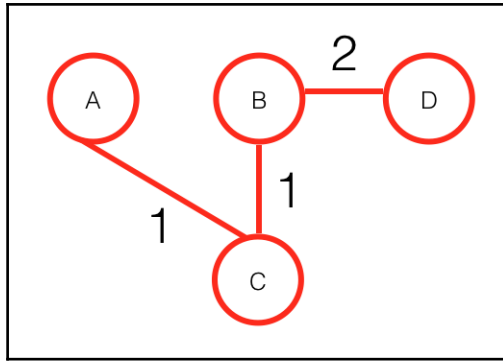

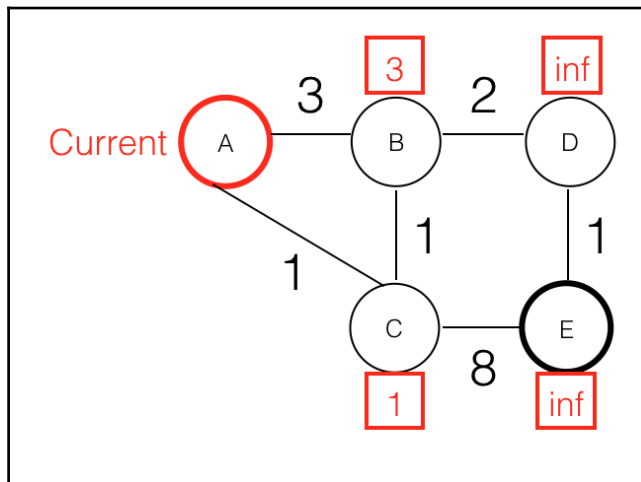
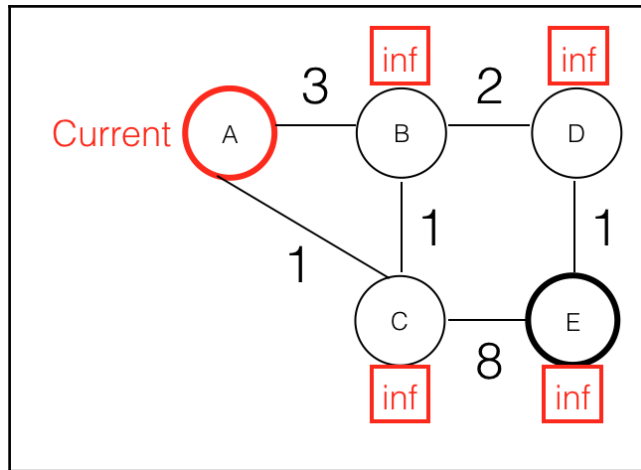

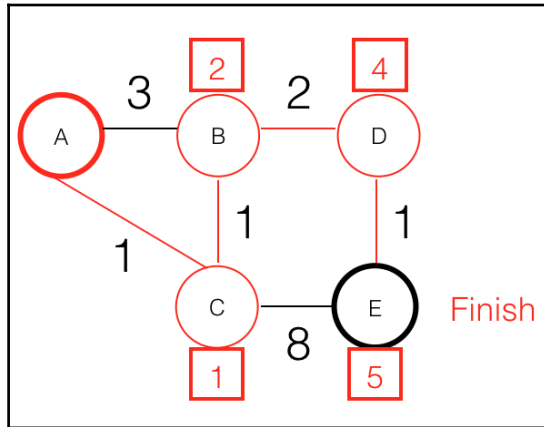
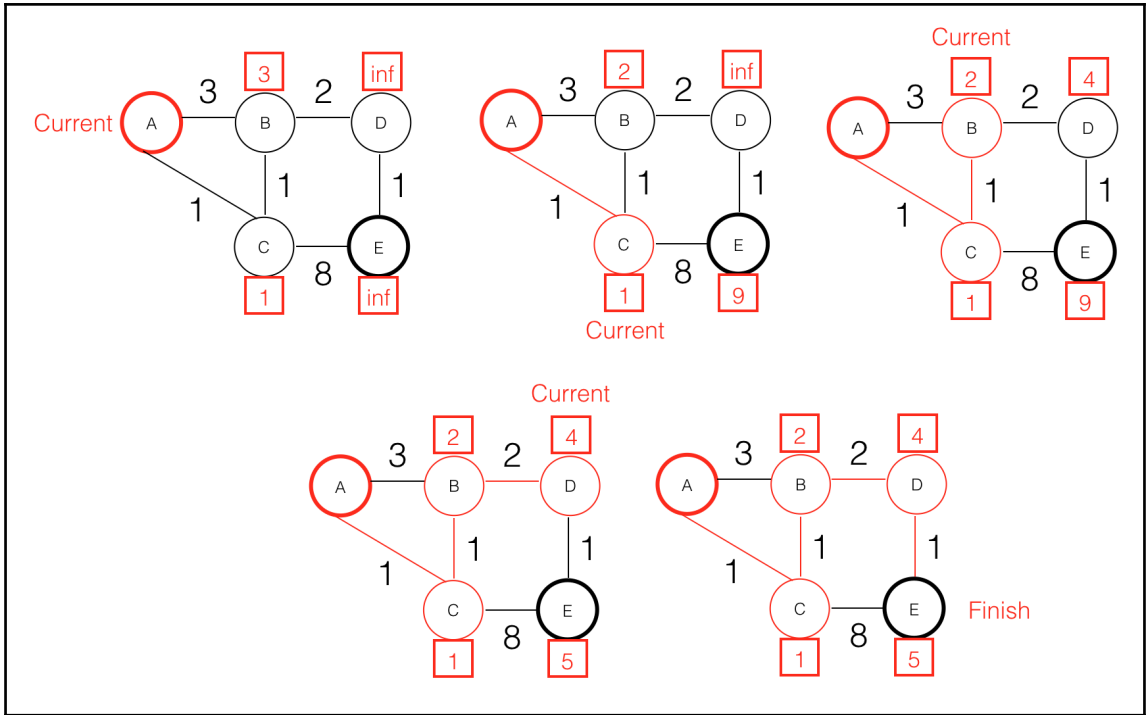

---

## Chapter 8: Performance and Algorithm Efficiency

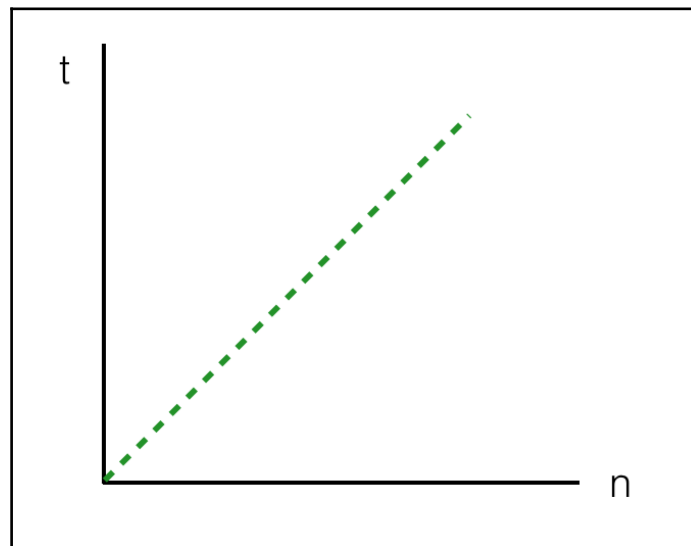
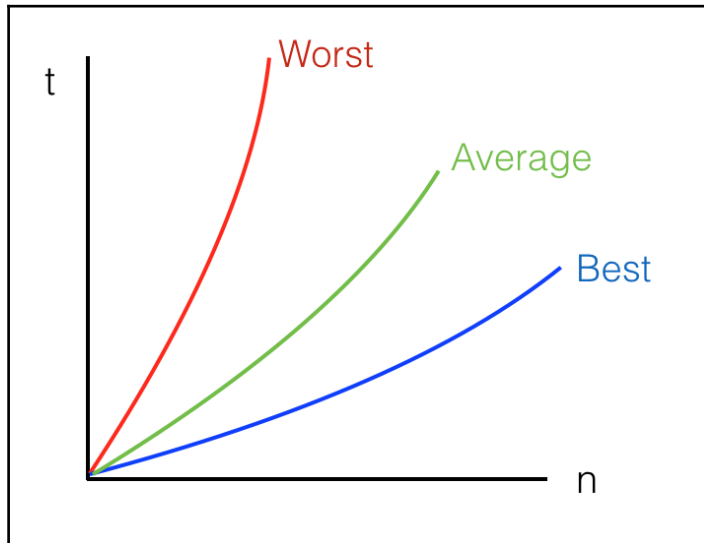

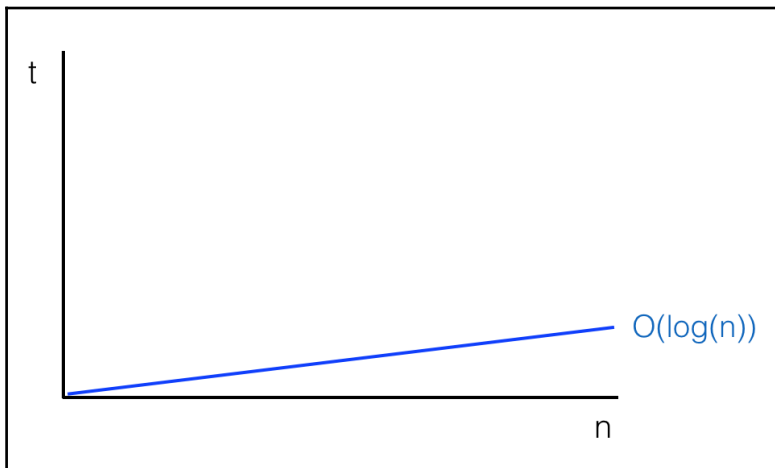
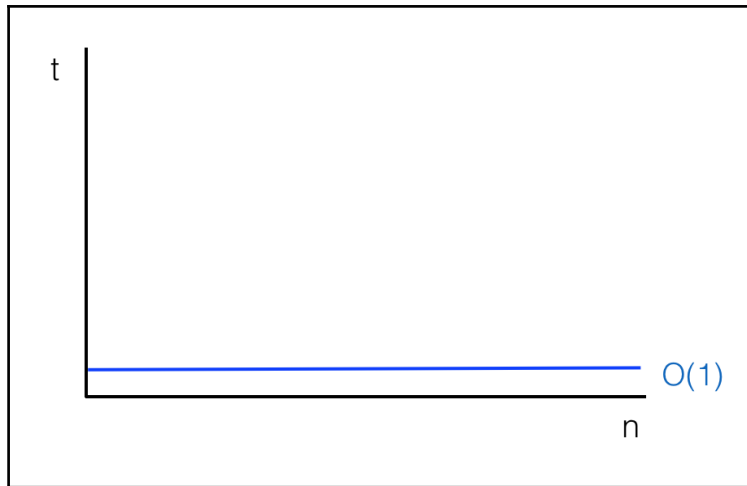

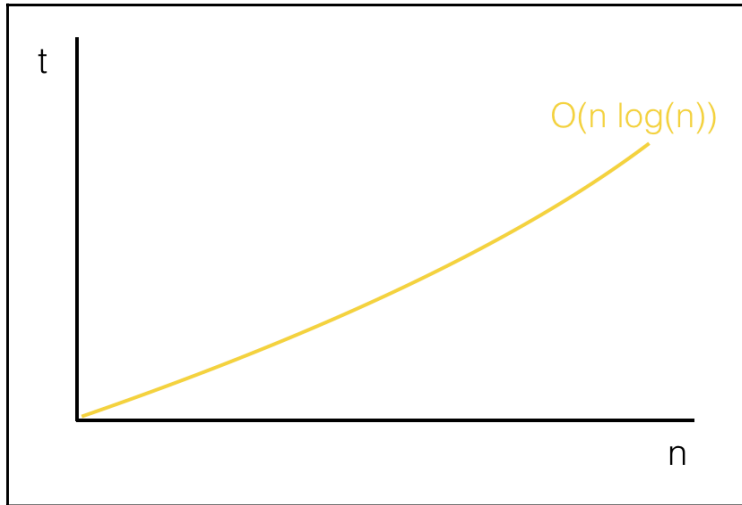
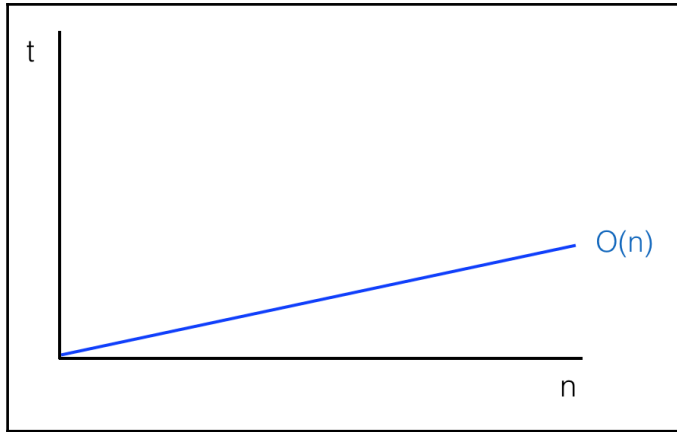

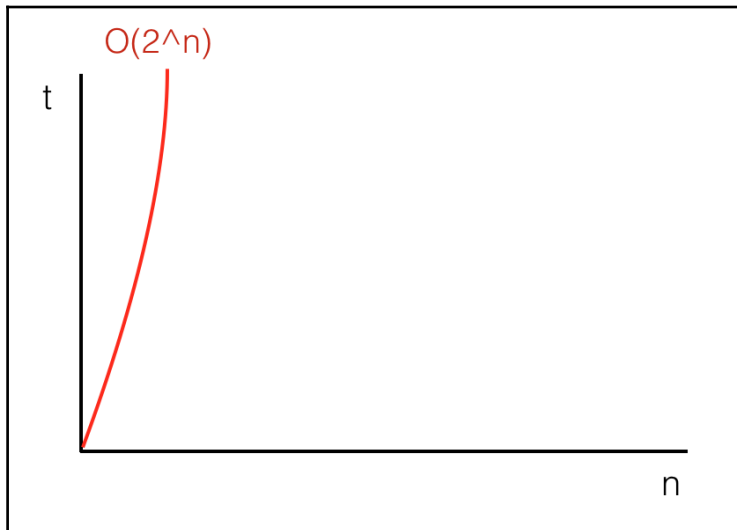
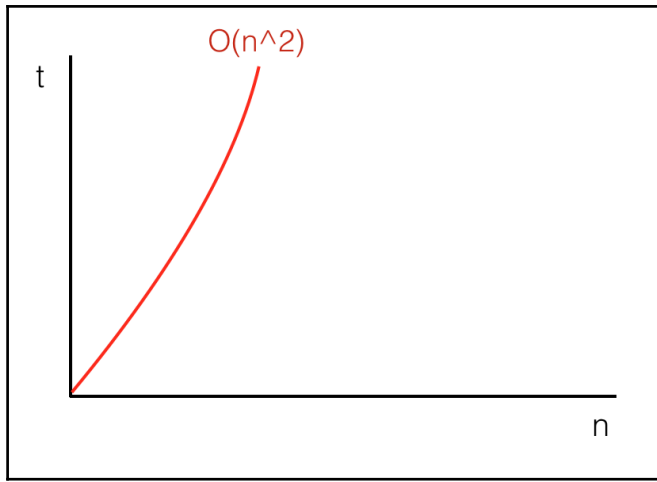



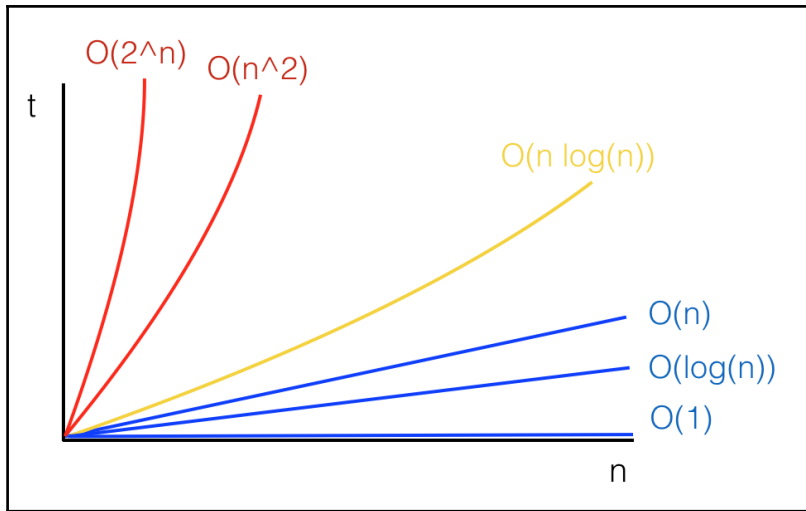

$n / f(n)$	$\log(n)$	$n$	$n \log(n)$	$n^2$	$2^n$	$n!$
10	0.003 $\mu$ s	0.01 $\mu$ s	0.033 $\mu$ s	0.1 $\mu$ s	1 $\mu$ s	3.63 ms
20	0.004 $\mu$ s	0.02 $\mu$ s	0.086 $\mu$ s	0.4 $\mu$ s	1ms	77.1 years
30	0.005 $\mu$ s	0.03 $\mu$ s	0.147 $\mu$ s	0.9 $\mu$ s	1s	$8.4 \times 10^{15}$ years
40	0.005 $\mu$ s	0.04 $\mu$ s	0.213 $\mu$ s	1.6 $\mu$ s	18.3 min	
50	0.006 $\mu$ s	0.05 $\mu$ s	0.282 $\mu$ s	2.5 $\mu$ s	13 days.	
100	0.007 $\mu$ s	0.1 $\mu$ s	0.644 $\mu$ s	10 $\mu$ s	$4 \times 10^{13}$ years	
1,000	0.010 $\mu$ s	1 $\mu$ s	9.966 $\mu$ s	1ms		
10,000	0.013 $\mu$ s	10 $\mu$ s	130 $\mu$ s	100ms		
100,000	0.017 $\mu$ s	0.10 ms	1.67 ms	10s		
1,000,000	0.020 $\mu$ s	1ms	19.93 ms	16.7 min		
10,000,000	0.023 $\mu$ s	0.01 s	0.23 s	1.16 days		
100,000,000	0.027 $\mu$ s	0.1 s	2.66 s	115.7 days		
1,000,000,000	0.030 $\mu$ s	1s	29.90 s	31.7 years		

---

# Chapter 9: Choosing the Perfect Algorithm

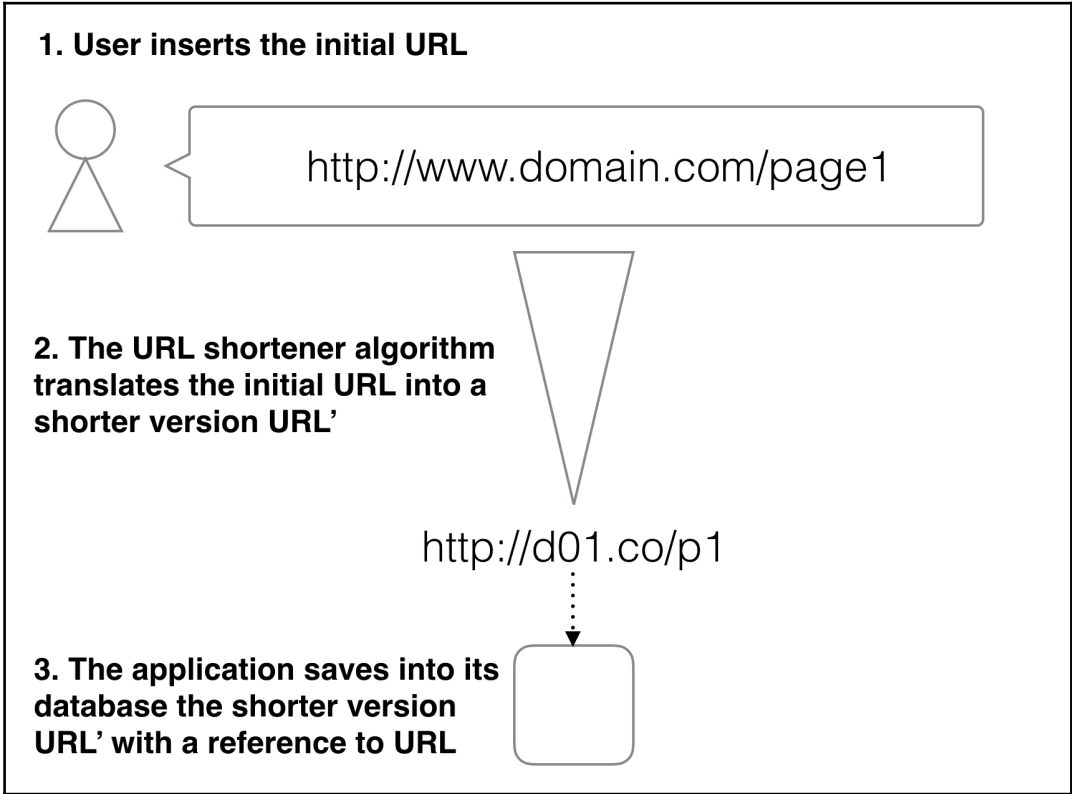

---

**1. User clicks on the shorter URL'**



**2. The URL shortener algorithm translates the URL' into the initial long version URL**



http://www.domain.com/page1



**3. The application redirects the user to the original URL**

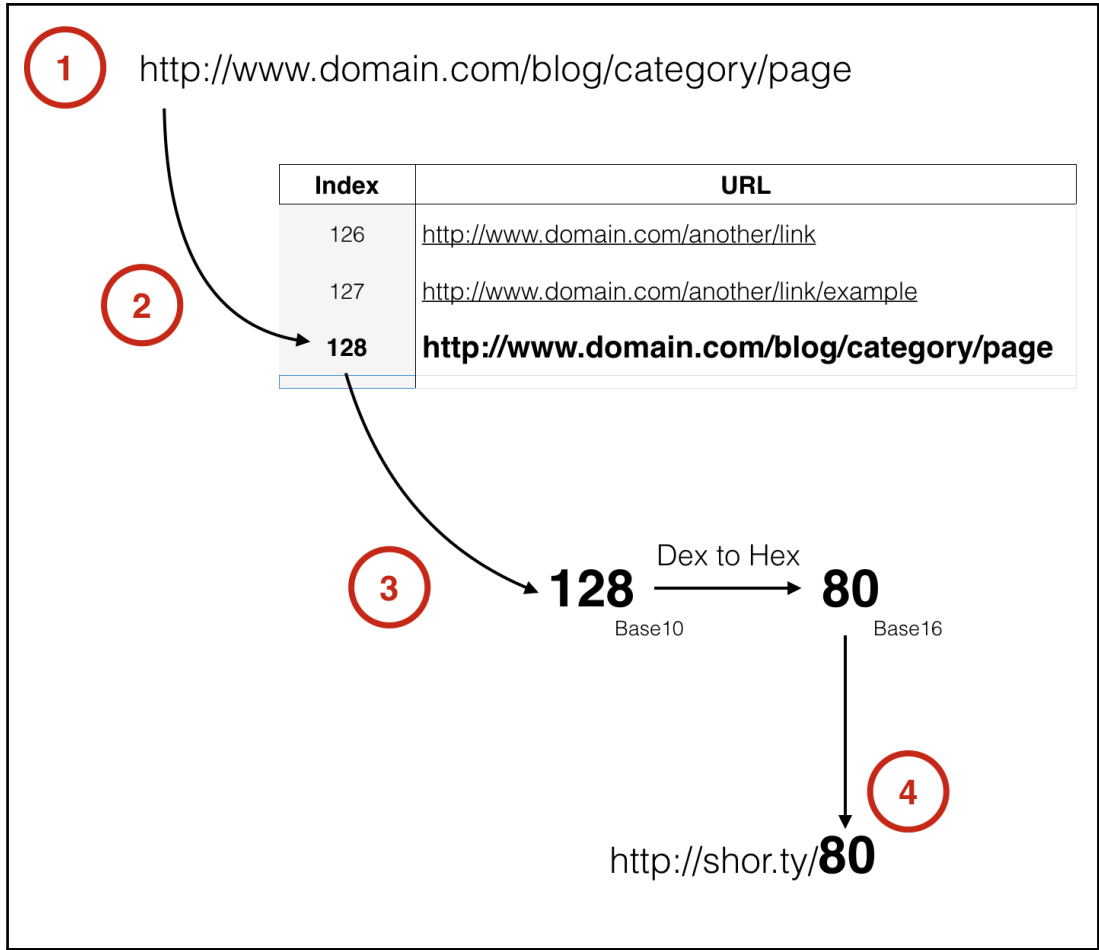

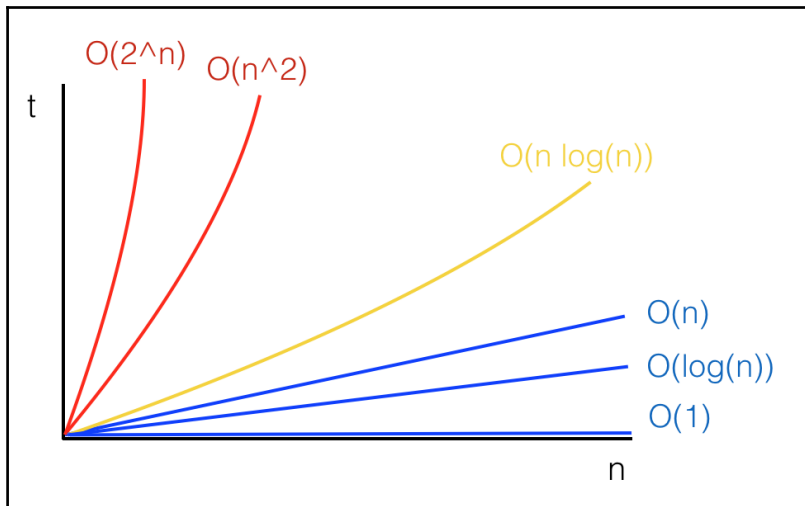
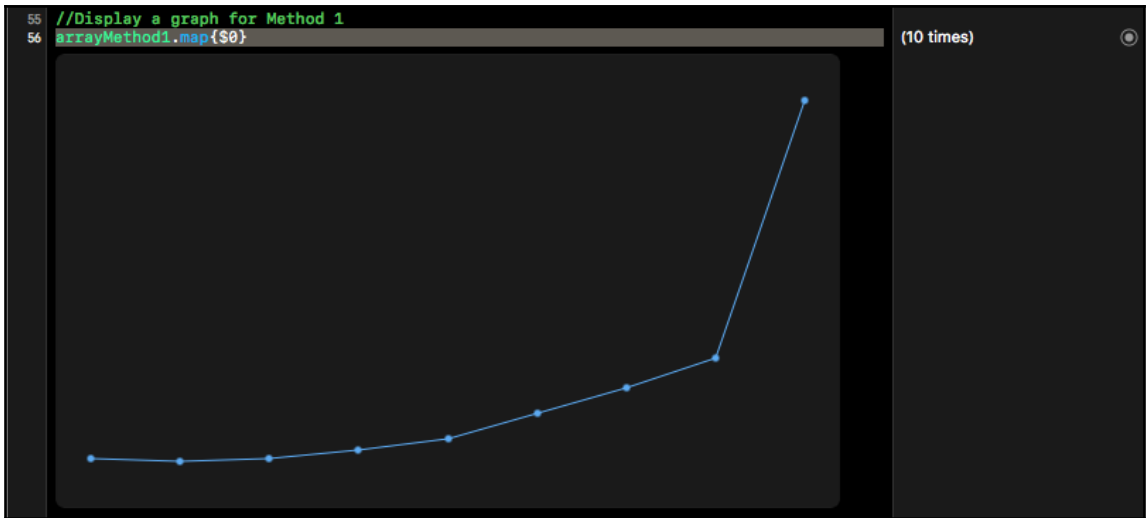

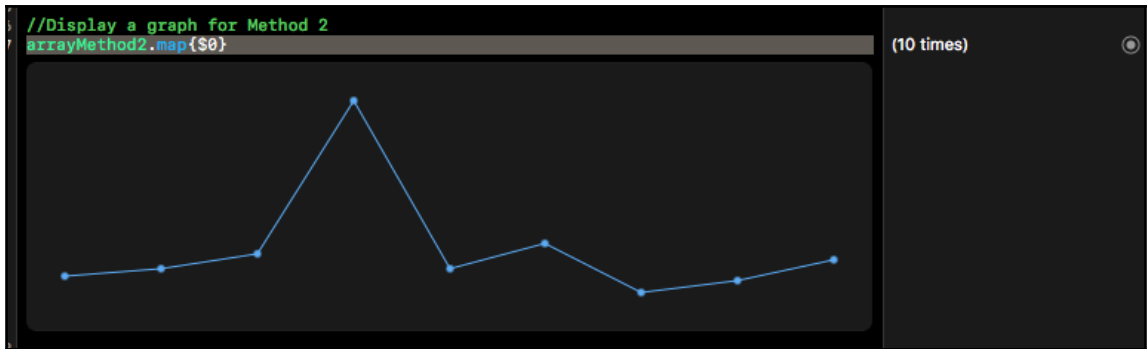

Time access	<a href="http://shor.ty/0">http://shor.ty/0</a>	<a href="http://shor.ty/2000">http://shor.ty/2000</a>	http://shor.ty/7000	http://shor.ty/18500
Method 1 (s)	0,00155	0,001551	0,00813	0,03130
Method 2 (s)	0,000352	0,00037	0,000352	0,000323
<b>Difference (ms)</b>	<b>0,1198</b>	<b>0,1181</b>	<b>0,7778</b>	<b>3,0977</b>

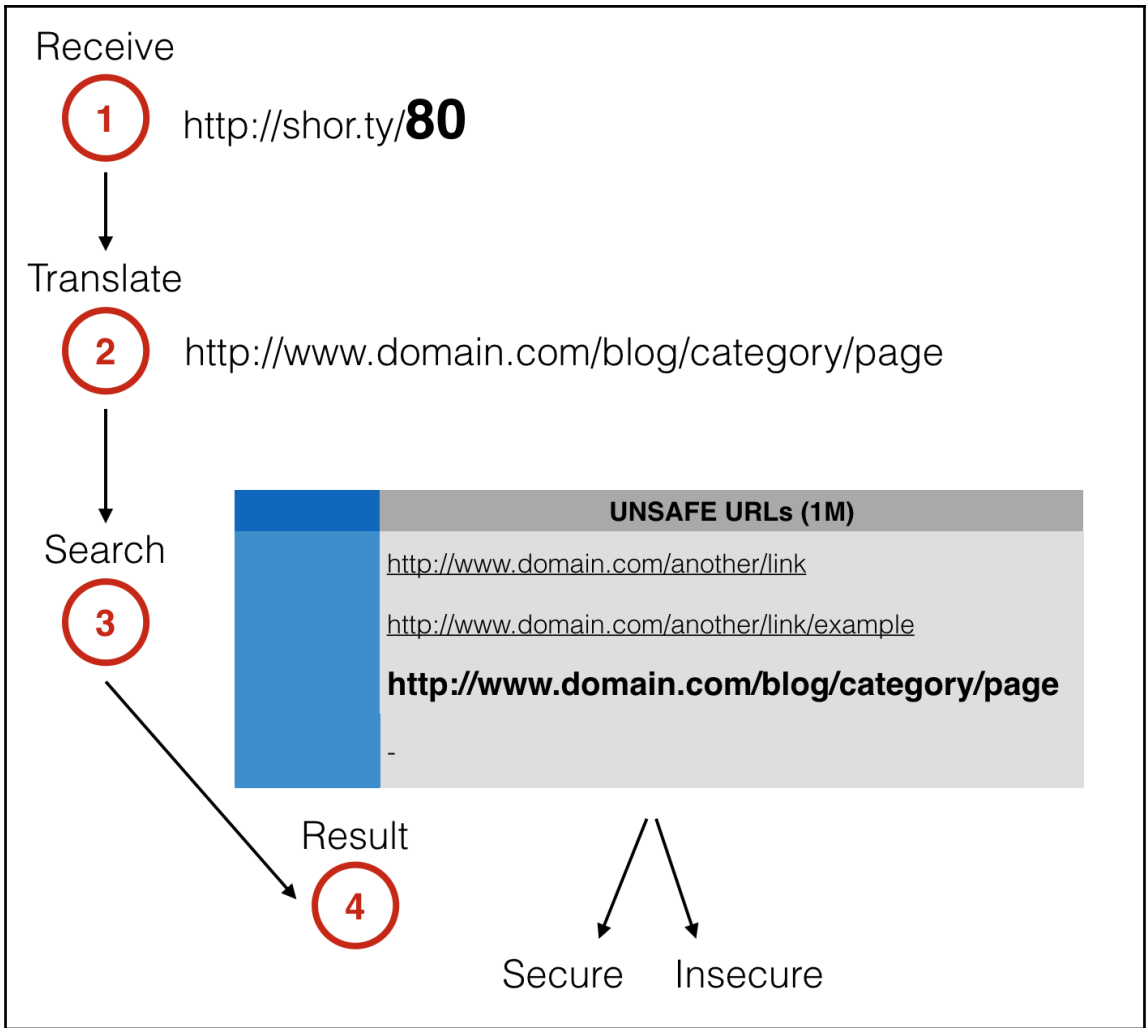

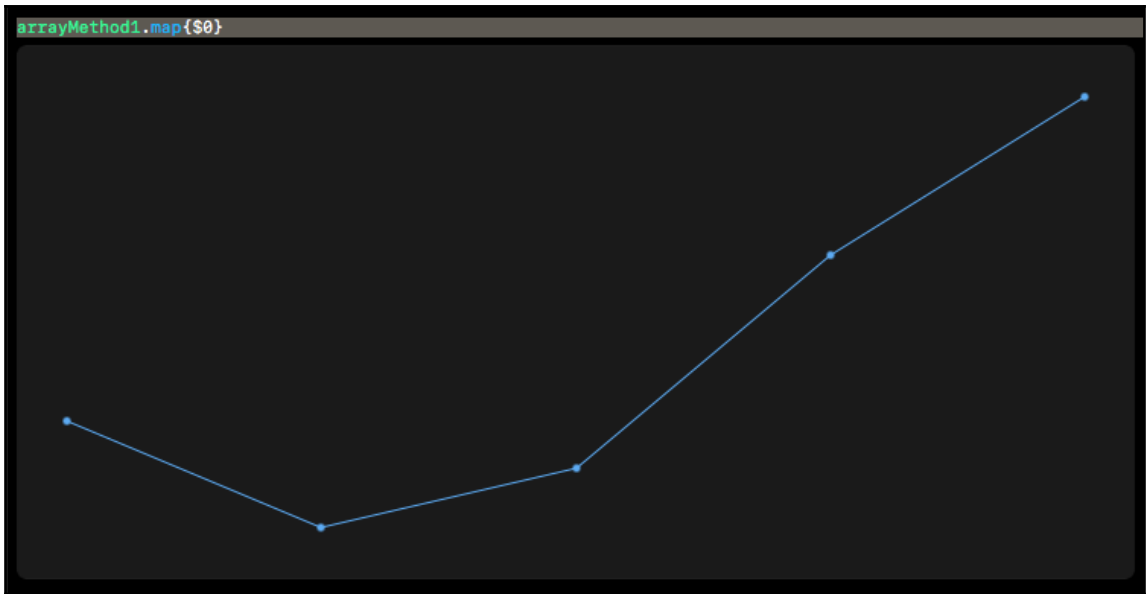

Time access	<a href="http://shor.ty/0">http://shor.ty/0</a>	<a href="http://shor.ty/2000">http://shor.ty/2000</a>	http://shor.ty/7000	http://shor.ty/18500	<a href="http://shor.ty/F4240">http://shor.ty/F4240</a>
Method 1 (s)	0,0013489	0,00048184	0,00095915	0,002686	0,0039761



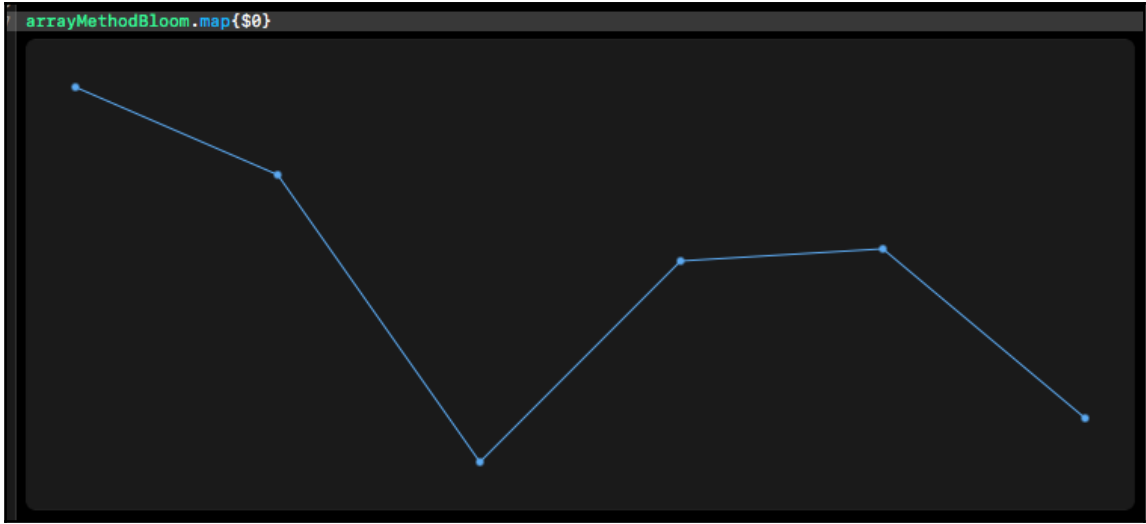

Time access	<a href="http://shor.ty/0">http://shor.ty/0</a>	<a href="http://shor.ty/2000">http://shor.ty/2000</a>	<a href="http://shor.ty/7000">http://shor.ty/7000</a>	<a href="http://shor.ty/18500">http://shor.ty/18500</a>	<a href="http://shor.ty/F4240">http://shor.ty/F4240</a>
Method 1 (s)	0,0013489	0,00048184	0,00095915	0,002686	0,0039761
Method 2 Bloom (s)	0,0002639	0,0002479	0,00019502	0,00023198	0,0002341
<b>Difference (ms)</b>	<b>0,1085</b>	<b>0,023394</b>	<b>0,076413</b>	<b>0,245402</b>	<b>0,3742</b>