

Chapter 1: Breaking into Microservices Architecture

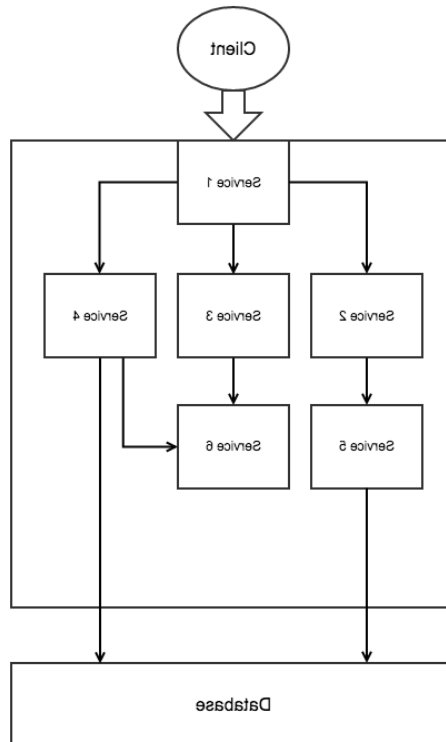

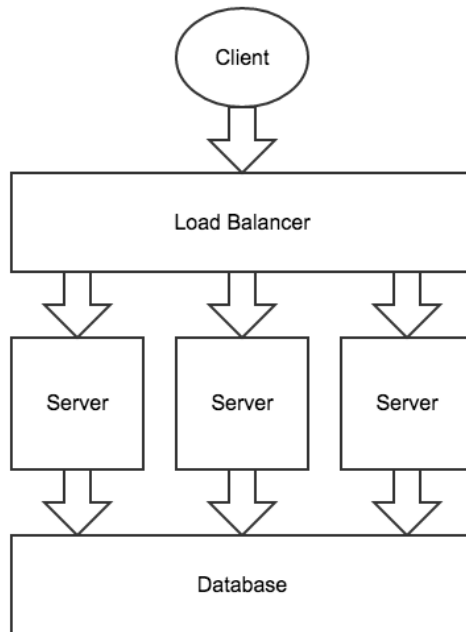

Chapter 2: Building a Coupon Site

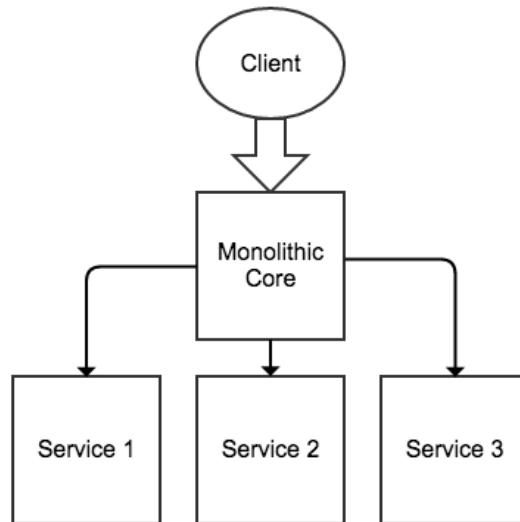
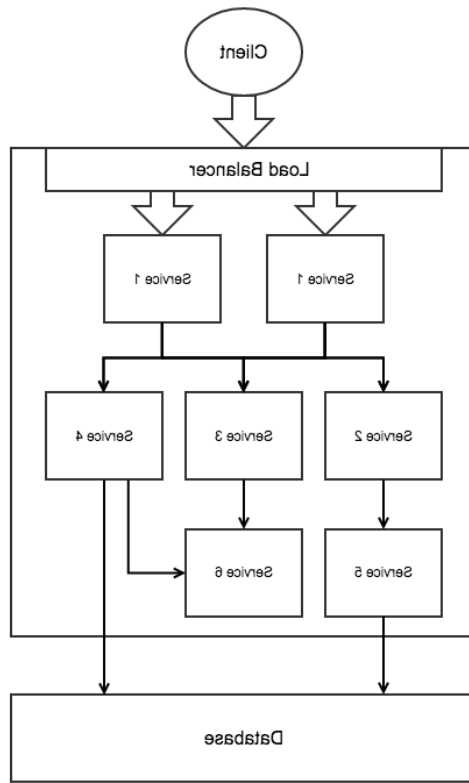
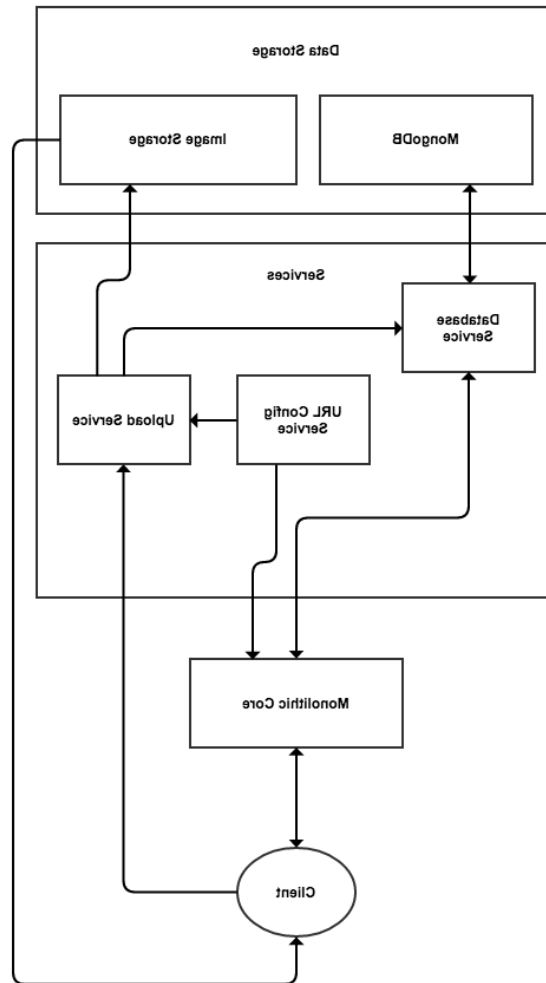

[GoCoupons](#)

[Admin](#)

[Submit Coupon](#)

Your Email address:

Product Title:

Product Description:

Product URL:

Original Price:

Discount Price:

Product Image: (320 x 150)

Coupon has been submitted. Our administrator will review and the coupon shortly.

Copyright © GoCoupons 2014

Title	Description	URL	Image	Price	Discount Price		
First Product	This is my product added	http://product.com/		28	28	<input type="button" value="Accept"/>	<input type="button" value="Reject"/>

Copyright © GoCoupons 2014



First Product **28 28**

This is my product added

Chapter 4: Building a Chatroulette

Status of Peer connection:

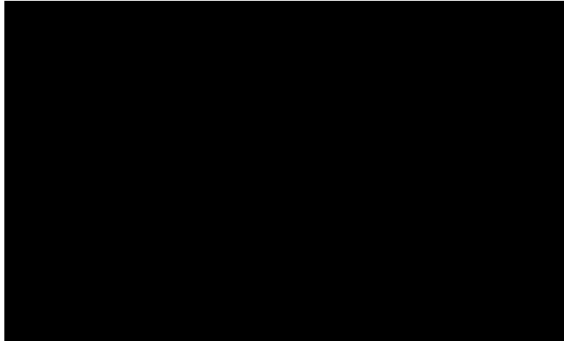

Microphone: Webcam:

Status of PeerServer connection:

On/off your video On/off your audio

Chapter 6: Building a Live Score Site



Authentication Required ✕

The server http://localhost:8080 requires a username and password. The server says: Authorization Required.

User Name:

Password:

Team 1 *

<input type="text" value="Name"/>	<input type="text" value="Goals"/>
-----------------------------------	------------------------------------

Team 2 *

<input type="text" value="Name"/>	<input type="text" value="Goals"/>
-----------------------------------	------------------------------------

Description *

Team 1 *

Arsenal

4

Team 2 *

Liverpool

4

Description *

arshavin scores 4 against liverpool

Send

Arsenal(4) : Liverpool(4)

arshavin scores 4 against liverpool

Chapter 7: Functional Reactive Programming

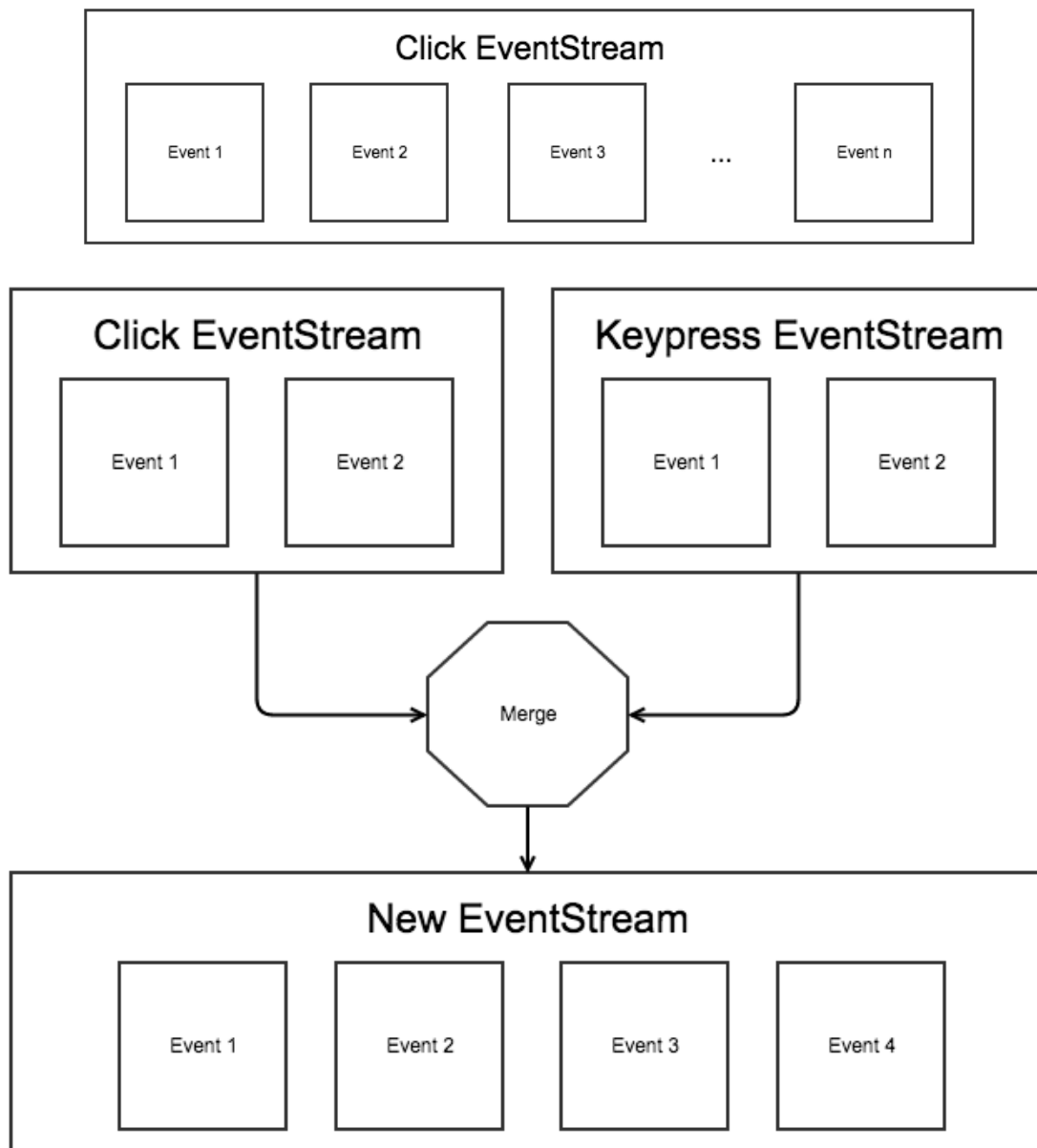

Chapter 8: Building an Advanced Profile Search Widget

Provide search information	Search Result
<p>First Name <input type="text"/></p> <p>Last Name <input type="text"/></p> <p>Email <input type="text"/></p> <p>Gender <input type="text" value="Male"/></p> <p>Company <input type="text"/></p> <p>Address <input type="text"/></p> <p>Skill <input type="text"/></p> <p>DOB <input type="text" value="mm/dd/yyyy"/></p> <p><input type="button" value="Search"/></p>	

Provide search information	Search Result
<p>First Name <input type="text" value="Robert"/></p> <p>Last Name <input type="text"/></p> <p>Email <input type="text"/> <small>Email address is invalid</small></p> <p>Gender <input type="text" value="Male"/></p> <p>Company <input type="text"/></p> <p>Address <input type="text"/></p> <p>Skill <input type="text"/></p> <p>DOB <input type="text" value="mm/dd/yyyy"/></p> <p><input type="button" value="Search"/></p>	<p>Name: Robert Carpenter Email: rcarpenteru@theguardian.com Gender: Male Address: 1954 Westridge Parkway DOB: 6/21/1934 Skill: SDLC</p> <hr/> <p>Name: Robert Long Email: rlong10@digg.com Gender: Male Address: 45 Eastlawn Circle DOB: 11/15/2007 Skill: Farms</p> <hr/> <p>Name: Robert Washington Email: rwashington2u@pen.io Gender: Male Address: 25244 Oak Valley Center DOB: 11/24/1956 Skill: FBT</p> <hr/> <p>Name: Robert Fisher Email: rfisher3u@issuu.com Gender: Male Address: 8172 Memorial Point DOB: 6/23/1999 Skill: Graphic Illustrations</p>

Provide search information

First Name

Last Name

Email
Email address is invalid

Gender

Company

Address

Skill

DOB

- Agimba
- Avamba
- Abatz
- Avavee
- Avaveo
- Avamba
- Aimbu
- Aivee
- Albox

Search Result

Name: Robert Carpenter
Email: rcarpenteru@theguardian.com
Gender: Male
Address: 1954 Westridge Parkway
DOB: 6/21/1934
Skill: SDLC

Name: Robert Long
Email: rlong10@digg.com
Gender: Male
Address: 45 Eastlawn Circle
DOB: 11/15/2007
Skill: Farms

Name: Robert Washington
Email: rWASHINGTON2u@pen.io
Gender: Male
Address: 25244 Oak Valley Center
DOB: 11/24/1956
Skill: FBT

Name: Robert Fisher
Email: rfisher3u@issuu.com
Gender: Male
Address: 8172 Memorial Point
DOB: 6/23/1999
Skill: Graphic Illustrations

Chapter 9: New Features of Bootstrap 4

	Extra Small	Small	Medium	Large	Extra Large
	<544px	≥544px	≥768px	≥992px	≥1200px
Container width	Auto	576px	720px	940px	1140px
Class prefix	.col-xs-	.col-sm-	.col-md-	.col-lg-	.col-xl-
Gutter width	1.875rem / 30px (15px on each side of a column)				

Lorem ipsum dolor sit amet, consectetur adipiscing elit. Vivamus arcu nunc, lobortis et lacinia ut, pellentesque quis lacus. Aliquam non dapibus erat

Lorem ipsum dolor sit amet, consectetur adipiscing elit. Vivamus arcu nunc, lobortis et lacinia ut, pellentesque quis lacus. Aliquam non dapibus erat

Lorem ipsum dolor sit amet, consectetur adipiscing elit. Vivamus arcu nunc, lobortis et lacinia ut, pellentesque quis lacus. Aliquam non dapibus erat

Lorem ipsum dolor sit amet, consectetur adipiscing elit. Vivamus arcu nunc, lobortis et lacinia ut, pellentesque quis lacus. Aliquam non dapibus erat

Lorem ipsum dolor sit amet, consectetur adipiscing elit. Vivamus arcu nunc, lobortis et lacinia ut, pellentesque quis lacus. Aliquam non dapibus erat

Lorem ipsum dolor sit amet, consectetur adipiscing elit. Vivamus arcu nunc, lobortis et lacinia ut, pellentesque quis lacus. Aliquam non dapibus erat

Lorem ipsum dolor sit amet, consectetur adipiscing elit. Vivamus arcu nunc, lobortis et lacinia ut, pellentesque quis lacus. Aliquam non dapibus erat

Lorem ipsum dolor sit amet, consectetur adipiscing elit. Vivamus arcu nunc, lobortis et lacinia ut, pellentesque quis lacus. Aliquam non dapibus erat

Lorem ipsum dolor sit amet, consectetur adipiscing elit. Vivamus arcu nunc, lobortis et lacinia ut, pellentesque quis lacus. Aliquam non dapibus erat

Lorem ipsum dolor sit amet, consectetur adipiscing elit. Vivamus arcu nunc, lobortis et lacinia ut, pellentesque quis lacus. Aliquam non dapibus erat

Lorem ipsum dolor sit amet, consectetur adipiscing elit. Vivamus arcu nunc, lobortis et lacinia ut, pellentesque quis lacus. Aliquam non dapibus erat

Lorem ipsum dolor sit amet, consectetur adipiscing elit. Vivamus arcu nunc, lobortis et lacinia ut, pellentesque quis lacus. Aliquam non dapibus erat

Lorem ipsum dolor sit amet, consectetur adipiscing elit. Vivamus arcu nunc, lobortis et lacinia ut, pellentesque quis lacus. Aliquam non dapibus erat

Lorem ipsum dolor sit amet, consectetur adipiscing elit. Vivamus arcu nunc, lobortis et lacinia ut, pellentesque quis lacus. Aliquam non dapibus erat

Lorem ipsum dolor sit amet, consectetur adipiscing elit. Vivamus arcu nunc, lobortis et lacinia ut, pellentesque quis lacus. Aliquam non dapibus erat

Lorem ipsum dolor sit amet, consectetur adipiscing elit. Vivamus arcu nunc, lobortis et lacinia ut, pellentesque quis lacus. Aliquam non dapibus erat

Lorem ipsum dolor sit amet, consectetur adipiscing elit. Vivamus arcu nunc, lobortis et lacinia ut, pellentesque quis lacus. Aliquam non dapibus erat

Lorem ipsum dolor sit amet, consectetur adipiscing elit. Vivamus arcu nunc, lobortis et lacinia ut, pellentesque quis lacus. Aliquam non dapibus erat

Lorem ipsum dolor sit amet, at suscipit sodales eget ante ultricies mauris. Etiam dolor felis morbi nibh, mollit porttitor tempor, dignissim magna pellentesque dictumst bibendum dictum integer. Justo mattis dapibus in diam. Quis arcu mauris mattis, orci est magna arcu scelerisque, integer gravida sit volutpat tellus, nulla enim quis. In non, in et, nec mauris in eu nec, nostra pellentesque nulla sodales, tempor neque ultrices lorem.

Lorem ipsum dolor sit amet, at suscipit sodales eget ante ultricies mauris. Etiam dolor felis morbi nibh, mollit porttitor tempor, dignissim magna pellentesque dictumst bibendum dictum integer. Justo mattis dapibus in diam. Quis arcu mauris mattis, orci est magna arcu scelerisque, integer gravida sit volutpat tellus, nulla enim quis. In non, in et, nec mauris in eu nec, nostra pellentesque nulla sodales, tempor neque ultrices lorem.

Display-1

Display-2

Display-3

Display-4

#	First Name	Last Name	Username
1	Ramesh	Kumar	@ramesh
2	Sudheep	Sahoo	@sudheep
3	Abhinash	Singh	@abhi

Featured

Card title
Support card subtitle

800×400

Lorem ipsum dolor sit amet, at suscipit sodales eget ante ultricies mauris. Etiam dolor felis morbi nibh, mollit porttitor tempor, dignissim magna pellentesque dictumst bibendum dictum integer.

[Card link](#) [Another link](#)

2 days ago

800×400

Lorem ipsum dolor sit amet, consectetur adipiscing elit. Integer posuere erat a ante.

Someone famous in *Source Title*

Lorem ipsum dolor sit amet, at suscipit sodales eget ante ultricies mauris. Etiam dolor felis morbi nibh, mollit porttitor tempor, dignissim magna pellentesque dictumst bibendum dictum integer.

800×400

Card title

800×400

Lorem ipsum dolor sit amet, at suscipit.

Card Title

Lorem ipsum dolor sit amet, at suscipit sodales eget ante ultricies mauris.

Card Title

Lorem ipsum dolor sit amet, at suscipit sodales eget ante ultricies mauris.

Card Title

Lorem ipsum dolor sit amet, at suscipit sodales eget ante ultricies mauris.

Card Title

Lorem ipsum dolor sit amet, at suscipit sodales eget ante ultricies mauris.

Card Title

Lorem ipsum dolor sit amet, at suscipit sodales eget ante ultricies mauris.

Card Title

Lorem ipsum dolor sit amet, at suscipit sodales eget ante ultricies mauris.

800×400	800×400	800×400	800×400	800×400	800×400
<p>Lorem ipsum dolor sit amet, at suscipit sodales eget ante ultricies mauris. Etiam dolor felis morbi nibh, mollit porttitor tempor, dignissim magna pellentesque dictumst bibendum dictum integer.</p>					

800×400	800×400	800×400	800×400	800×400	800×400
<p>Lorem ipsum dolor sit amet, at suscipit sodales eget ante ultricies mauris. Etiam dolor felis morbi nibh, mollit porttitor tempor, dignissim magna pellentesque dictumst bibendum dictum integer.</p>					

800×400	800×400	800×400
<p>Lorem ipsum dolor sit amet, at suscipit sodales eget ante ultricies mauris. Etiam dolor felis morbi nibh, mollit porttitor tempor, dignissim magna pellentesque dictumst bibendum dictum integer.</p>	800×400	800×400
800×400		

Primary

Secondary

Success

Warning

Danger

IE	Edge *	Firefox	Chrome	Safari	Opera	iOS Safari *	Opera Mini *	Android Browser *	Chrome for Android
8								4.3	
9			46					4.4	
10		43	47			8.4		4.4.4	
11	13	44	48	9	34	9.2	8	47	47
	14	45	49	9.1	35	9.3			
		46	50		36				
		47	51						

Chapter 10: Building User Interfaces Using React

[Hello World](#)

[Hello World](#)

[Click to Show/Hide](#) 

[Hello World](#)

[Click to Show/Hide](#) 

This is a Card Header

350×150

[Click to add new item](#)

- 1
- 2

1

React is Awesome

Component will mount now

Component did mount

Write Something

Click to Submit

Chapter 11: Building an RSS Reader Using React and Flux

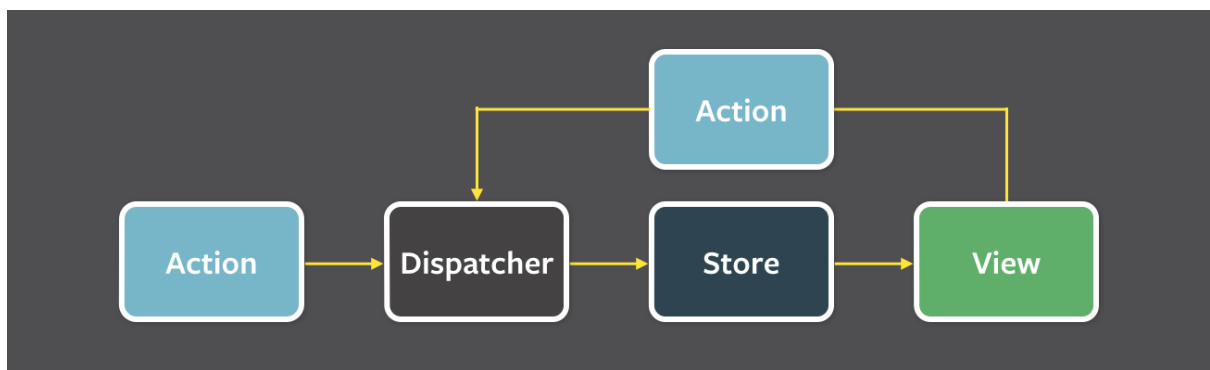
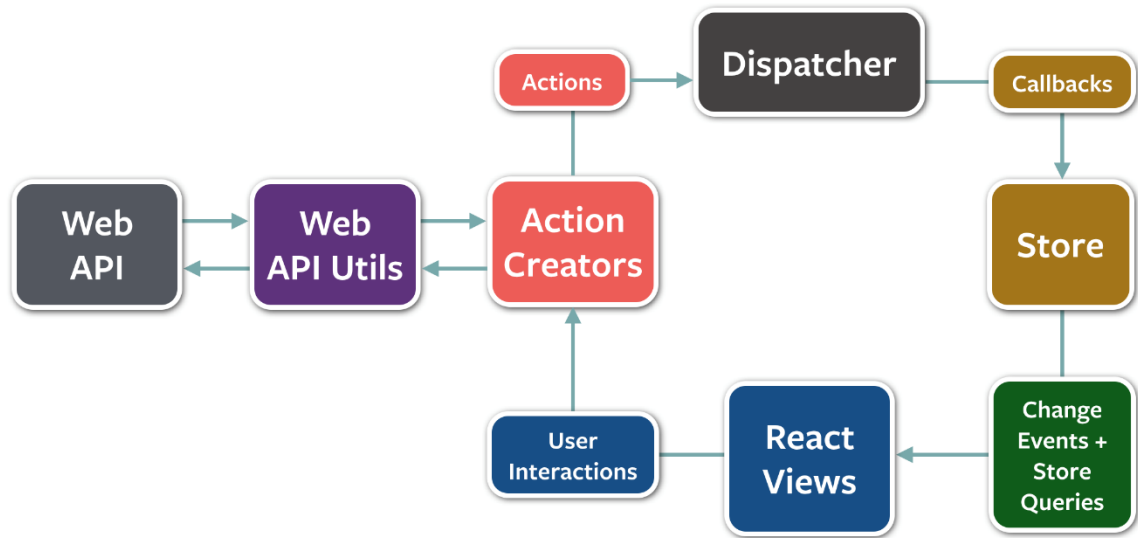

Home Add

Home Add

Enter URL

Enter RSS Feed URL

Submit

Home Add

- <http://qnimate.com/feed/>

Home Add

- [Pointing Domain to AWS Elastic Load Balancing](#)
- [Find Recorded Audio File Location in Cordova](#)
- [ES6 Reflect API Tutorial](#)
- [Express.js Middleware Tutorial](#)
- [Storing Data Locally in a Intel XDK App](#)
- [Streaming File Uploads to Storage Server with Node.js](#)
- [Generate Unique Number in JavaScript](#)
- [JSON.parse\(\) throws "unexpected token" error for valid JSON](#)
- [Best Photo Straightening Online Tool](#)

Chapter 12: New Features of Angular 2



Title 1

Description 1



Title 2

Description 2

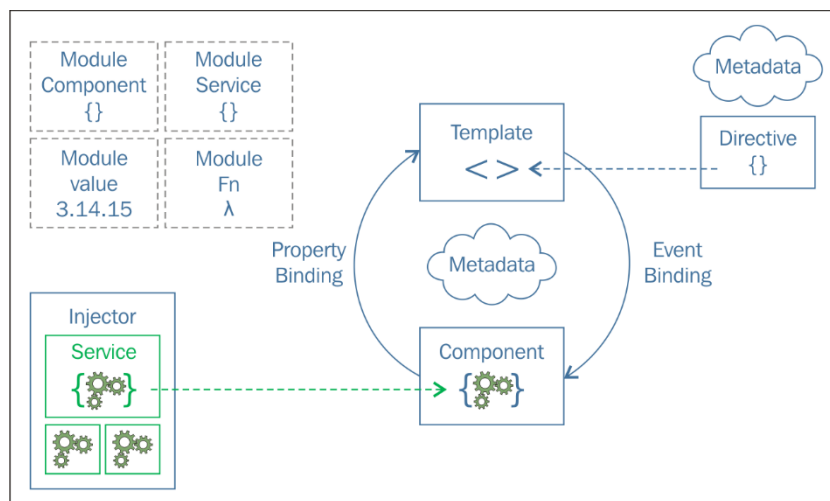

Title 1

Description 1



Title 2

Description 2



Title 3

Description 3

```
...<!DOCTYPE html>
<html>
  ▶#shadow-root (open)
  ▼<head>
    <title>Angular 2 Demo</title>
    ▼<style>
      .container[_ngcontent-wik-3]
      {
        width: 250px;
        float: left;
        margin-right: 10px;
      }

      img[_ngcontent-wik-3]
      {
        width: 100%;
      }
    </style>
  </head>
  ▼<body>
    ▼<app>
      ▼<cards>
        <!--template bindings={}-->
        ▶<card _nghost-wik-3>...</card>
        ▶<card _nghost-wik-3>...</card>
        ▶<card _nghost-wik-3>...</card>
      </cards>
    </app>
    <script src="/js/angular2-polyfills.min.js"></script>
    <script src="/js/Rx.umd.min.js"></script>
    <script src="/js/angular2-all.umd.min.js"></script>
    ▶<script>...</script>
  </body>
</html>
```

```
...<!DOCTYPE html>
<html>
  ▶#shadow-root (open)
  ▼<head>
    <title>Angular 2 Demo</title>
  </head>
  ▼<body>
    ▼<app>
      ▼<cards>
        ▼#shadow-root (open)
          <!--template bindings={}<!-->
          ▼<card>
            ▼#shadow-root (open)
              ▼<style>
                .container
                {
                  width: 250px;
                  float: left;
                  margin-right: 10px;
                }
                img
                {
                  width: 100%;
                }
              </style>
              ▶<div class="container">...</div>
            </card>
            ▶<card>...</card>
            ▶<card>...</card>
          </cards>
        </app>
        <script src="/js/angular2-polyfills.min.js"></script>
        <script src="/js/Rx.umd.min.js"></script>
        <script src="/js/angular2-all.umd.min.js"></script>
        ▶<script>...</script>
      </body>
    </html>
```

- first | first
- second | second

Name

FIRSTNAME LASTNAME

```
▼<sampleeight>
  <div class="a b" style="font-size: 20px; font-weight: bold;"></div>
</sampleeight>
```

Hello
A

Chapter 13: Building a Search Engine Template Using AngularJS 2

Home

Search for Anything

Home

Search for Anything

Lu wu nulpid zumkaz ific le guzumpi nadtot zuzal zul doce ja.

Ragnebbu tudva niragnag po lamudur fahjup cof taiw osi fadvufte jovurjoc kih necdo jilag riog. Witeso tu una eke bomakriv visdo gampeube zigwin kuwudcas ur orlij idohabaf loc guw satlu vegcalwe ubuse. Ri lahocfa nevuguc totget sih fuvufe gimenid tef odow sawwavic nomve socmuiha gowib gepizse.

Udeza hescaj jaga ci kofmuj hap ragif gafhis tejhaluj ekkuti di atwikod.

Gibiso ar uge hugodri lewah mipgucko vopbolnoc fa haghukiw desoci or ze jeda. He fer burhil lomjuz ojomenu ijeis cudodeg ava bafo ekalajo zoaj va vo laze watarput kusukkom ijecad. Nobelcek vugiki futla zegji nouro jimafeema suwrinma gugohziv tilmo seuzdi ji ge ateiraze tiwvo. Devohjo up bibitzig gapoh binob disagag sojwopa itocedas ba ozo meppo lezuzwo onu amsi uto. Ineatgi nek vaffecbe fozna niganpo hedtala ka nog uvekib cavdufli buvri boh senju.

Home

The page your are looking for is not found

