

Chapter 1: Data Science Using Java

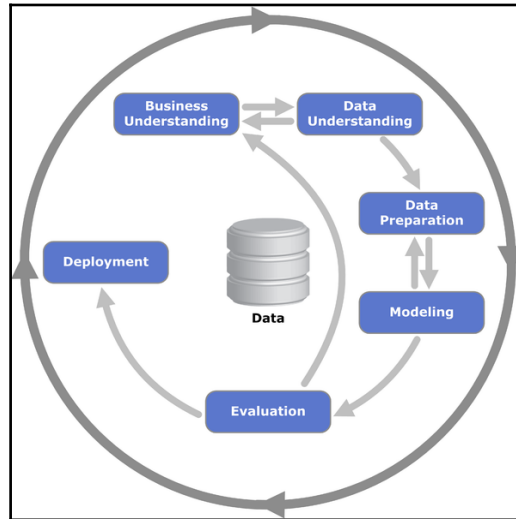

Chapter 2: Data Processing Toolbox

Order	Column Title	Data Type
1	word	Fixed Number of Words ▼
2	pos	Custom List ▼

Order	Column Title	Data Type	Examples	Options
1	name	Names ▼	John Smith ▼	Name Surname
2	email	Email ▼	No examples available.	No options available.
3	country	Country ▼	No examples available.	<input type="checkbox"/> Limit countries to those selected above
4	salary	Currency ▼	Please Select ▼	Format: XXXXXX Range 25000 To 150000 Currency Symbol \$ prefix ▼
5	experience	Number Range ▼	No examples available.	Between 0 and 50

Private Leaderboard - Avito Duplicate Ads Detection | Kaggle - Mozilla Firefox

Private Leaderboard - ...

https://www.kaggle.com/c/avito-duplicate-ads-c

This competition has completed. This leaderboard reflects the final standings.

See someone using multiple accounts? [Let us know.](#)

#	Rank	Team Name	Score	Entries	Last Submission UTC (Best - Last Submission)
1	—	Devil Team	0.95829	162	Mon, 11 Jul 2016 23:09:03 (-0.7h)
2	—	TheQuants	0.95294	197	Mon, 11 Jul 2016 19:53:15 (-46.7h)
3	—	ADAD	0.94971	226	Mon, 11 Jul 2016 23:57:54
4	—	8 + 9 = 11	0.94694	193	Mon, 11 Jul 2016 13:01:32 (-6.3h)
5	—	ololobhi	0.94587	133	Mon, 11 Jul 2016 22:18:01
6	—	otivA	0.94560	117	Mon, 11 Jul 2016 13:09:48 (-0.1h)
7	—	Native Russian Speakers :P	0.94449	43	Mon, 11 Jul 2016 22:49:32 (-1.3h)
8	↑1	frist	0.94438	158	Mon, 11 Jul 2016 21:28:56 (-1h)
9	↓1	DataMinders	0.94411	244	Mon, 11 Jul 2016 17:51:57
10	↑1	Pavel Blinov	0.94272	91	Mon, 11 Jul 2016 20:02:24 (-0.1h)
11	↓1	Li-Der	0.94262	67	Wed, 06 Jul 2016 04:08:42 (-12.4d)

The image shows a browser window with a Kaggle leaderboard and its developer tools. The browser title is "Inspector - Private Leaderboard - Avito Duplicate Ads Detection | Kaggle". The page content includes a message "This competition has completed" and a table with the following data:

#	Rank	Team Name	model uploaded * in the money	Score	Entries	Last Submission UTC (Best - LastSubmissions)
1	-	Devil Team	👤 +*	0.95829	162	Mon, 11 Jul 2016 23:09:03 (-0.7h)
2	-	The Queens	👤 +*	0.95704	167	Mon, 11 Jul 2016 19:53:15 (-1.7h)

The developer tools show the HTML structure for the selected element `table#leaderboard-table.oddeventable`. The structure is as follows:

```
<div#leaderboard-container>  
  <script type="text/javascript">jQuery(function ($) { ...</script>  
  <div id="comp-dash-header" class="comp-sidebar"></div>  
  <div class="private-leaderboard---avito-duplicate-ads-detection-page  
  comp-content full-width">  
    <div class="comp-content-inside">  
      <div id="competition-intro"></div>  
      <div id="leaderboard-conditions">This competition has completed. T...</div>  
      <div id="puppet-message"></div>  
      <div id="leaderboard-container">  
        <table id="leaderboard-table" class="oddeventable">  
          <colgroup></colgroup>  
          <tbody>
```

Chapter 3: Exploratory Data Analysis

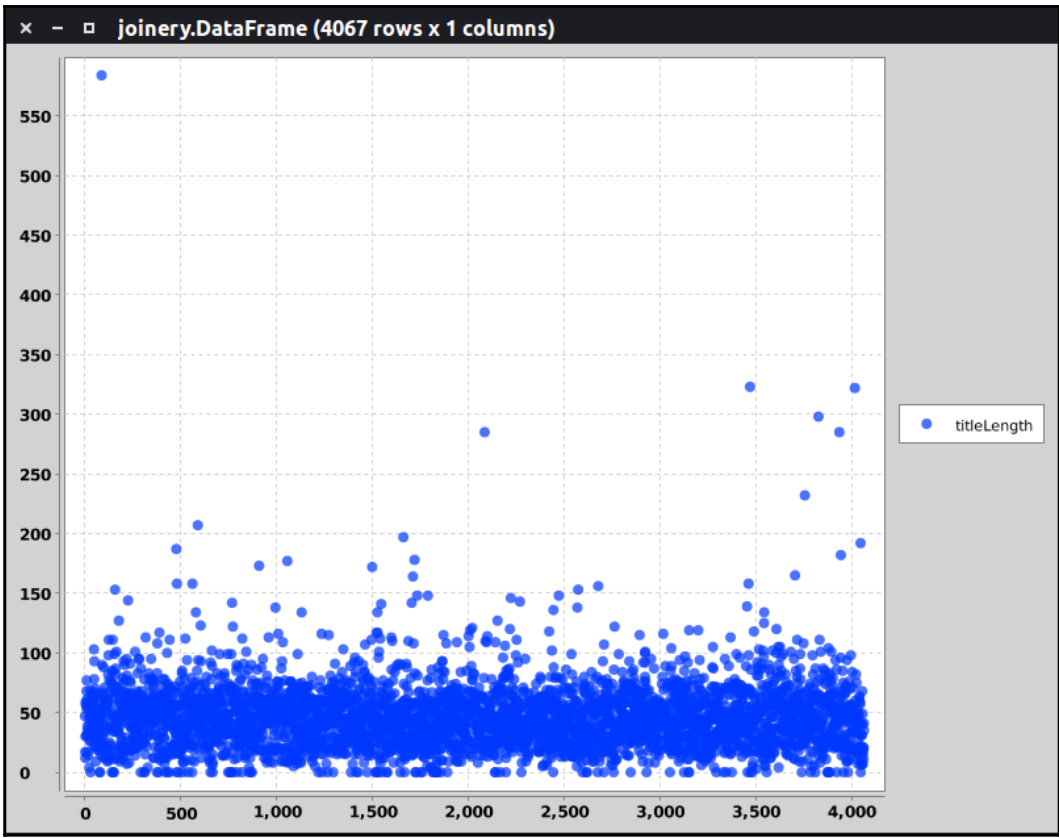

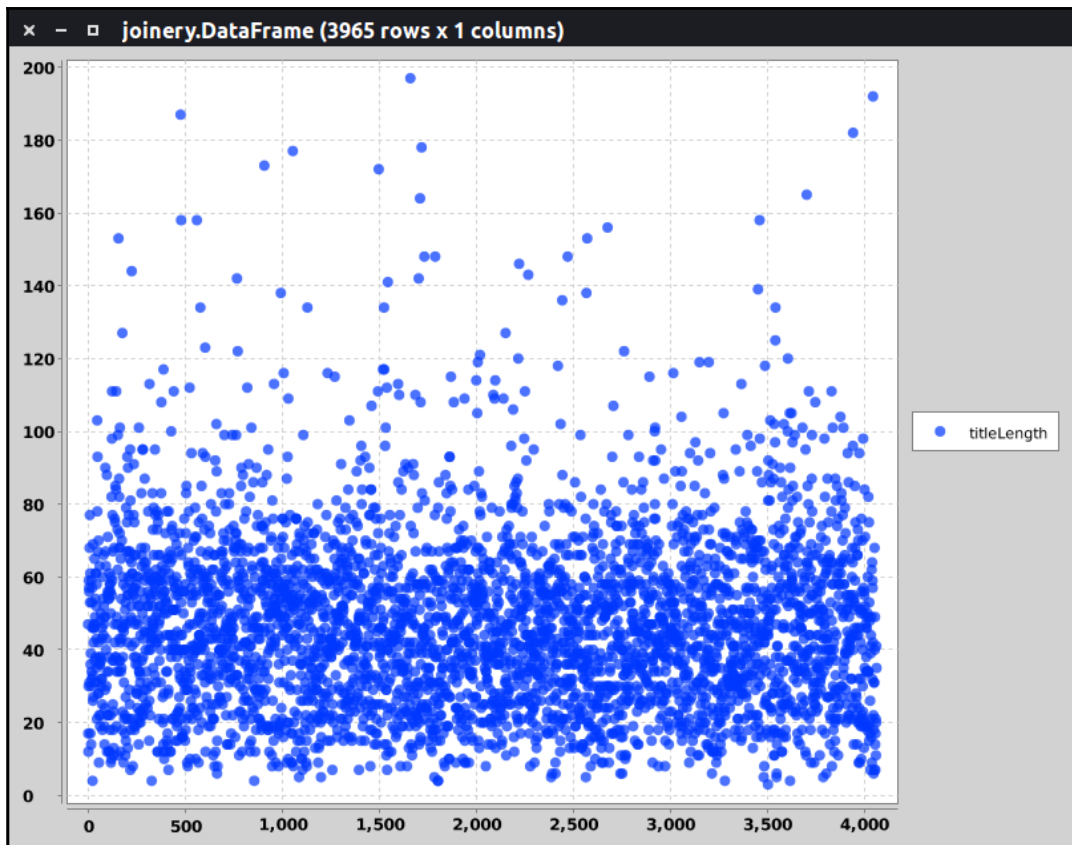

Chapter 4: Supervised Learning - Classification and Regression

		Actual Class y	
		Positive	Negative
$h_\theta(x)$ Predicted outcome	Predicted positive outcome	True positive (TP)	False positive (FP)
	Predicted negative outcome	False negative (FN)	True negative (TN)

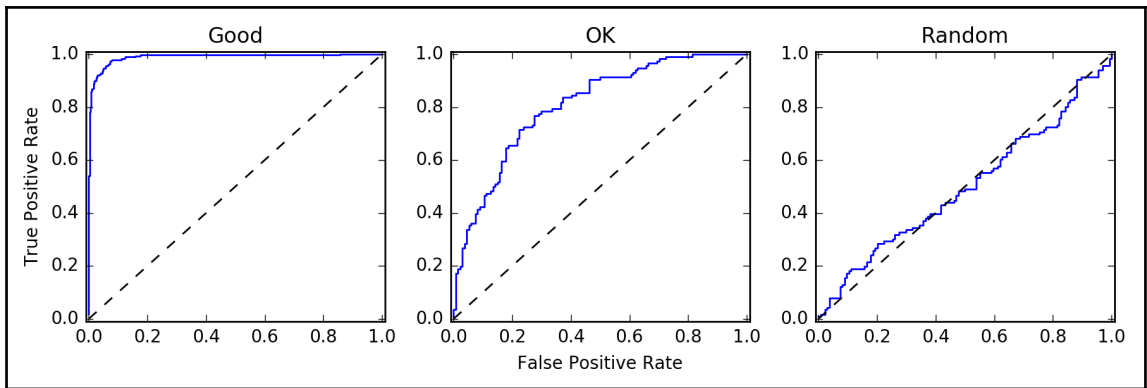

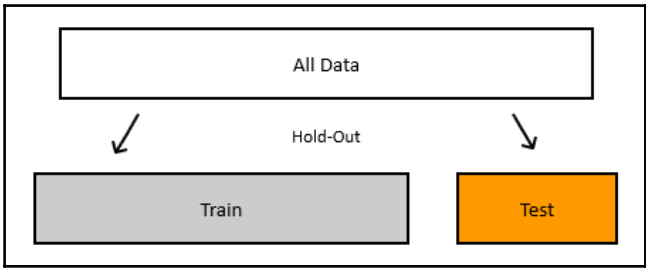
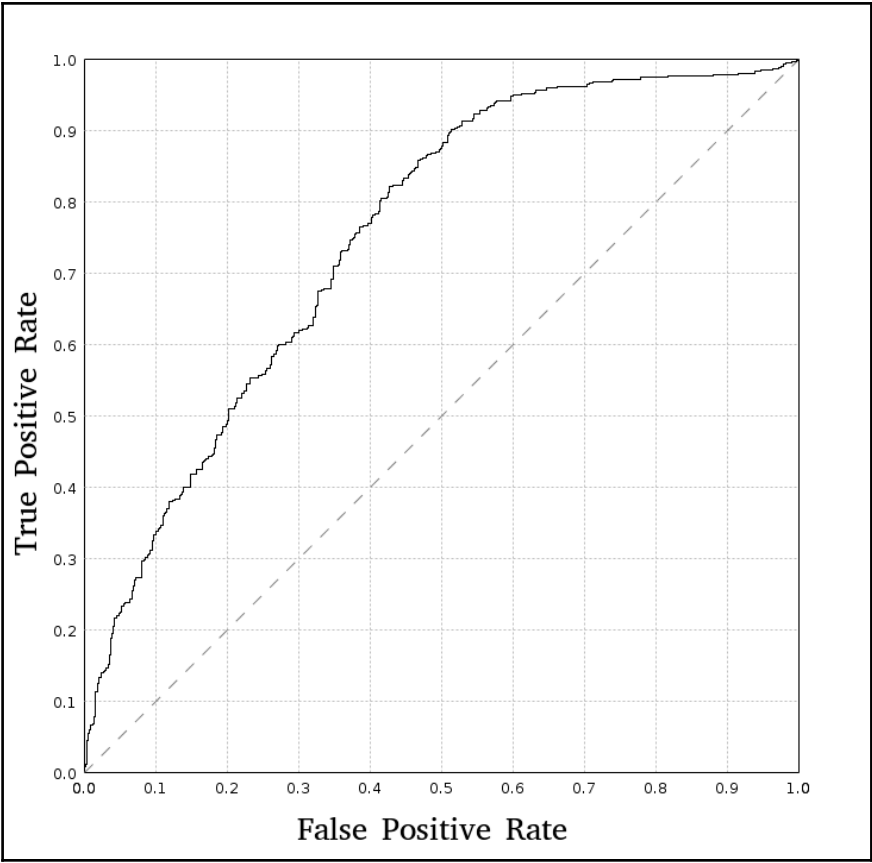

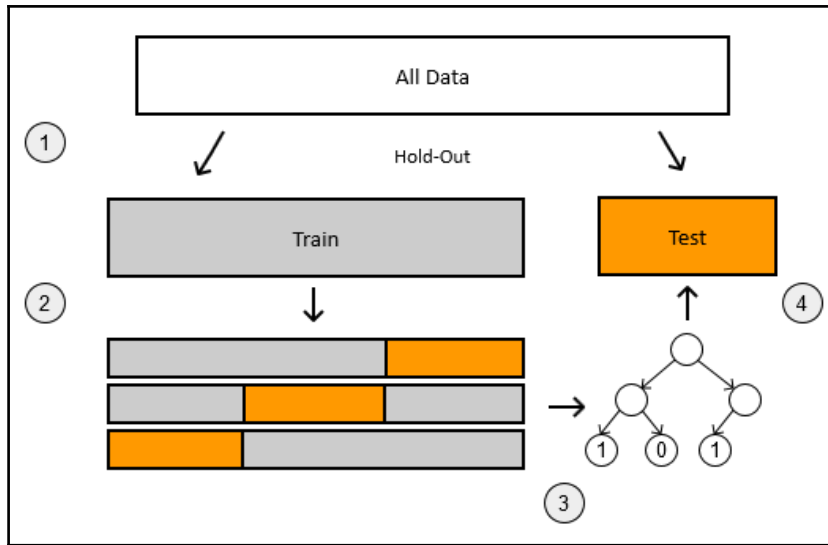

Chapter 5: Unsupervised Learning - Clustering and Dimensionality Reduction

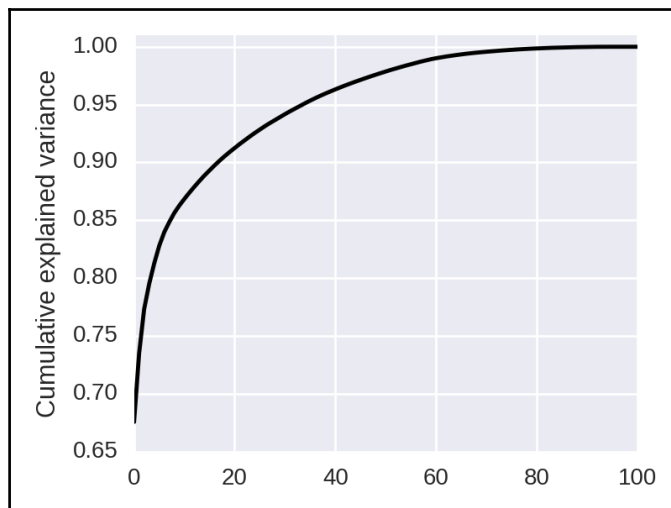

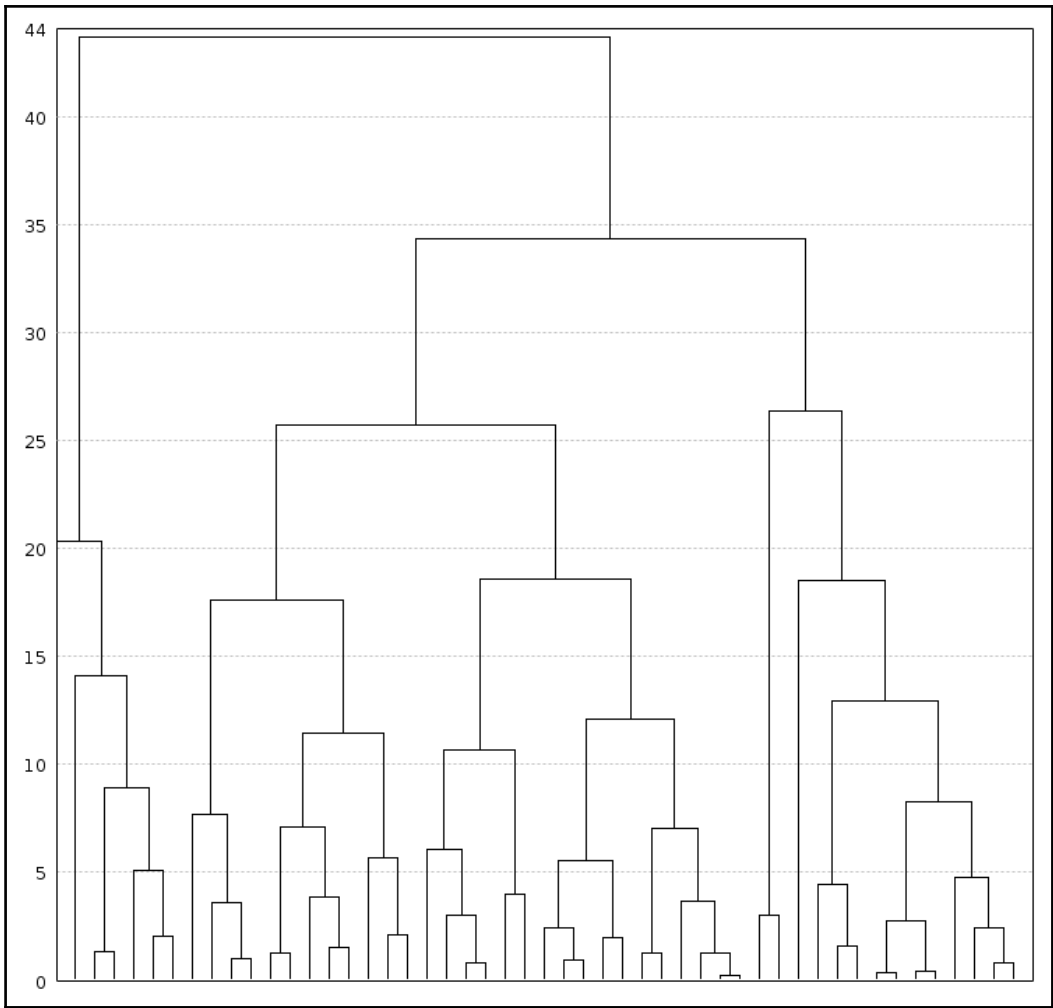

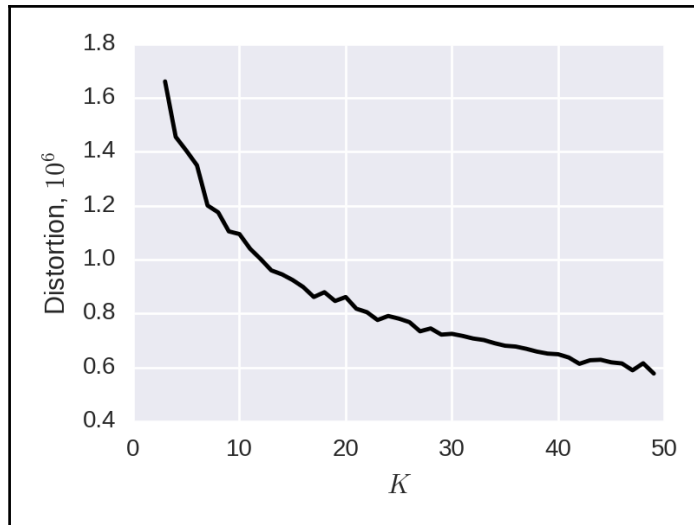

Chapter 6: Working with Text - Natural Language Processing and Information Retrieval

	because	data	development	enterprise	for	good	is	java	science	Use	we
doc1	1	1			1			1	1	1	2
doc2			1	1	1	1	1	1			

Chapter 7: Extreme Gradient Boosting

qid	1	1	1	1	2	2	2	3	3	3	3	3
size	4				3			5				

qid	query	url
1	adidas basketball shoes	http://www.adidas.com/us/men-basketball-shoes
1	adidas basketball shoes	http://www.adidas.com/us/basketball
1	adidas basketball shoes	http://www.eastbay.com/adidas/Basketball/Shoes/_/_/N-x8Z1e1Zne
2	angry birds	https://www.angrybirds.com/
2	angry birds	http://chrome.angrybirds.com/
2	angry birds	http://www.youtube.com/channel/UCYC2wjLop-S6Ld4raeoUVNA
2	angry birds	http://www.rovio.com/index.php?page=angry-birds
3	animal shelter	http://www.animalshelter.org/
3	animal shelter	https://www.petfinder.com/animal-shelters-and-rescues
3	animal shelter	https://www.animalhouseshelter.com/pets/berlin/
3	animal shelter	https://www.petfinder.com/
3	animal shelter	http://www.adoptapet.com/adoption_rescue/80291.html

Chapter 8: Deep Learning with DeepLearning4J

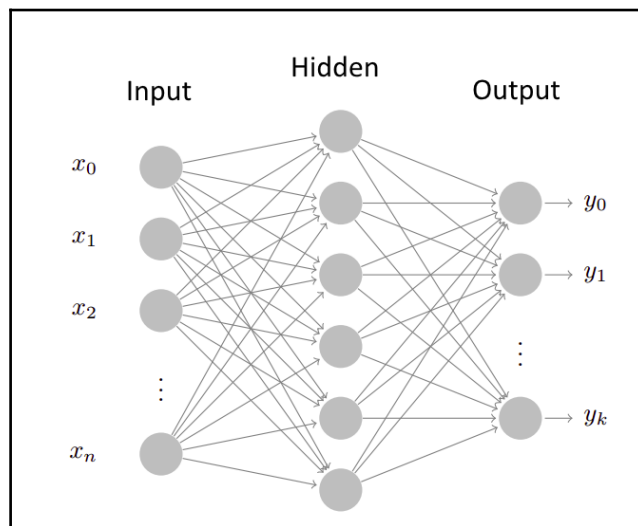

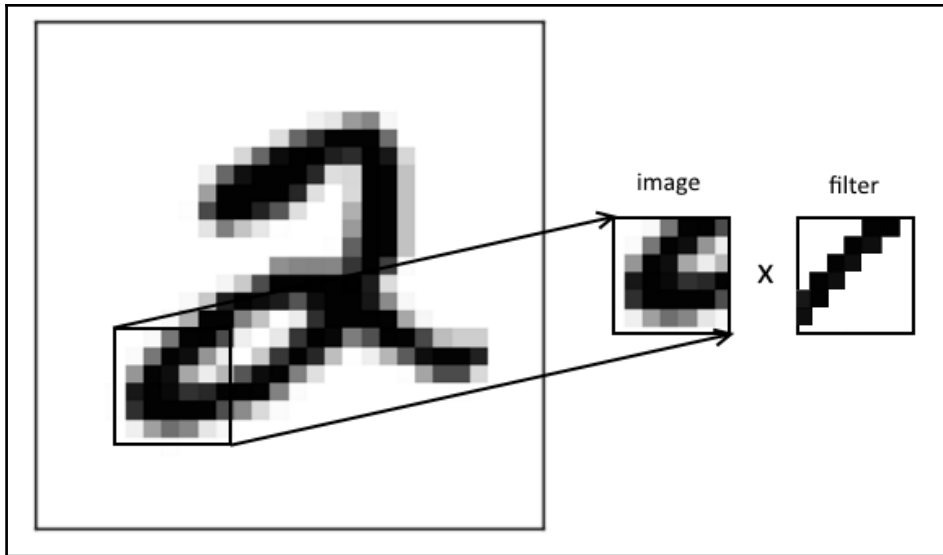
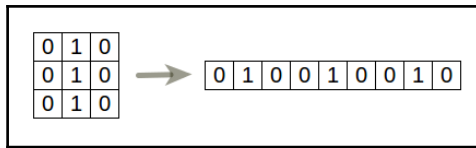

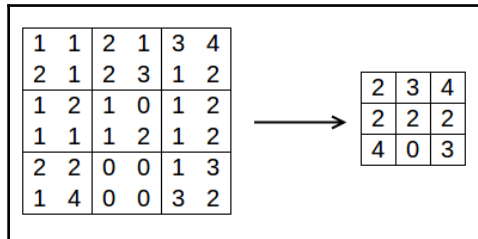
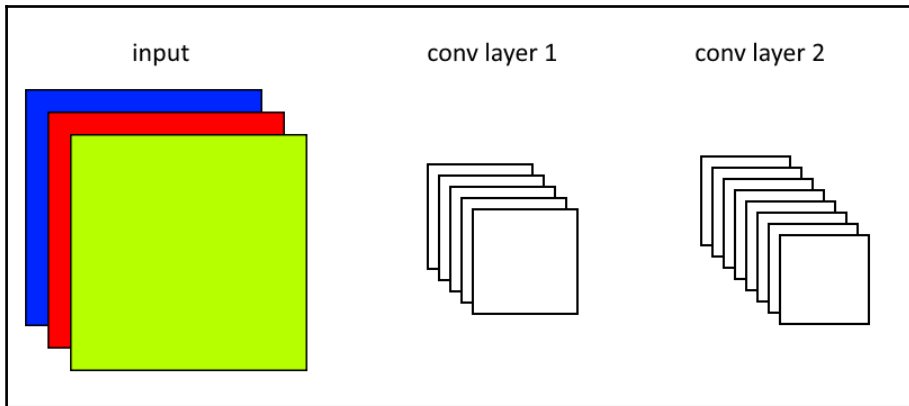
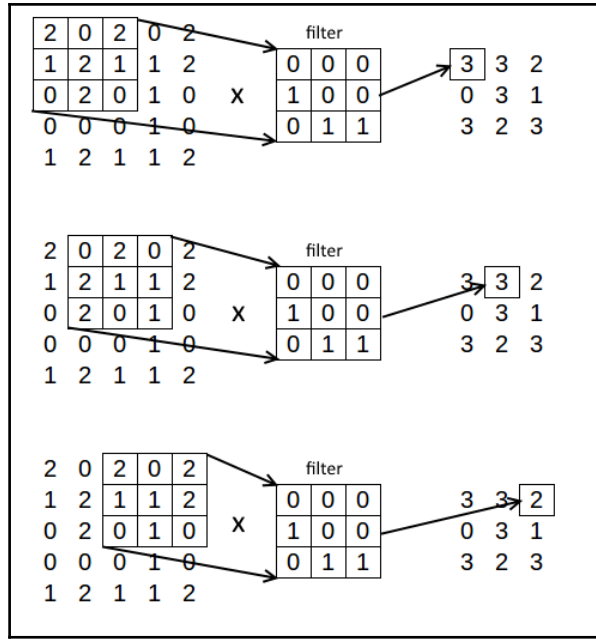

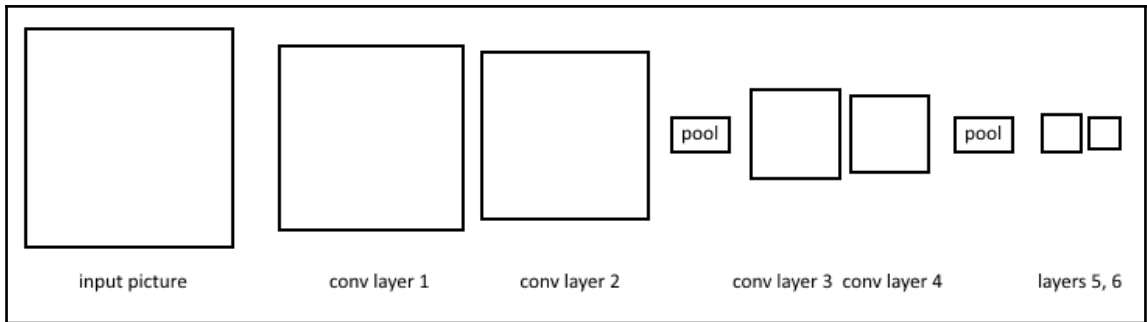

DL4J Training UI

- Overview
- Model
- System
- Language

Model Score vs. Iteration

Score: -0.00999, Iteration: 2889

Model and Training Information

Model Type	MultiLayerNetwork
Layers	12
Total Parameters	9856546
Start Time	
Total Runtime	
Last Update	2016-12-23 08:56:34
Total Parameter Updates	2851
Updates/sec	.06
Examples/sec	2.86

Update:Parameter Ratios (Mean Magnitudes): log₁₀

Standard Deviations: log₁₀

Updates	Gradients	Activations
0		
1		
2		
3		
4		
5		
6		
7		
8		
9		
10		
input		

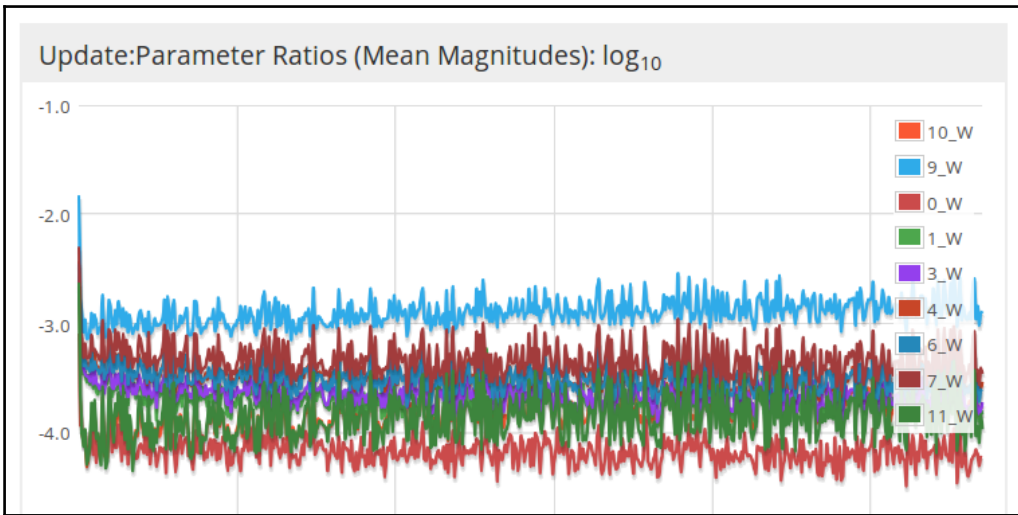
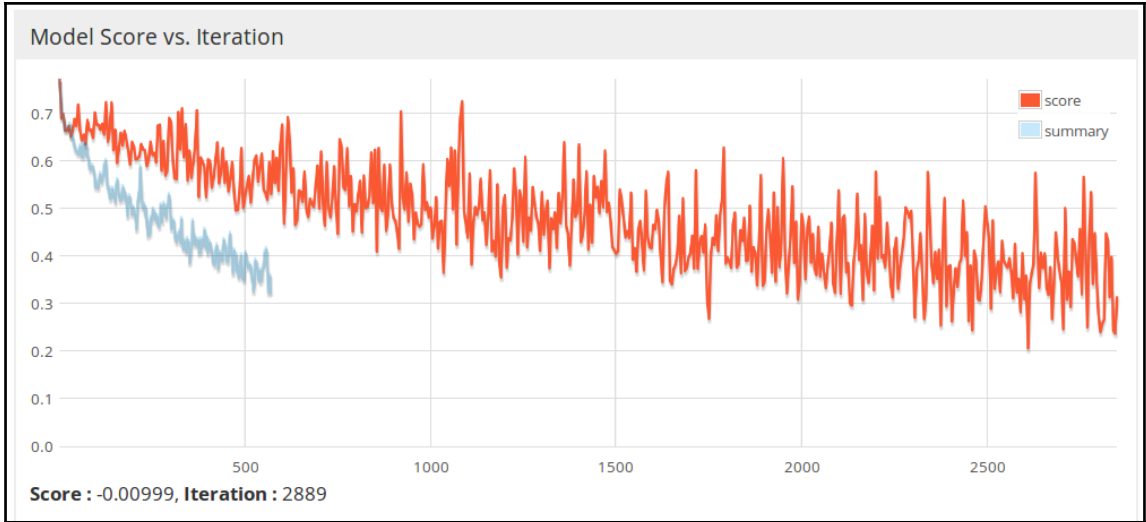

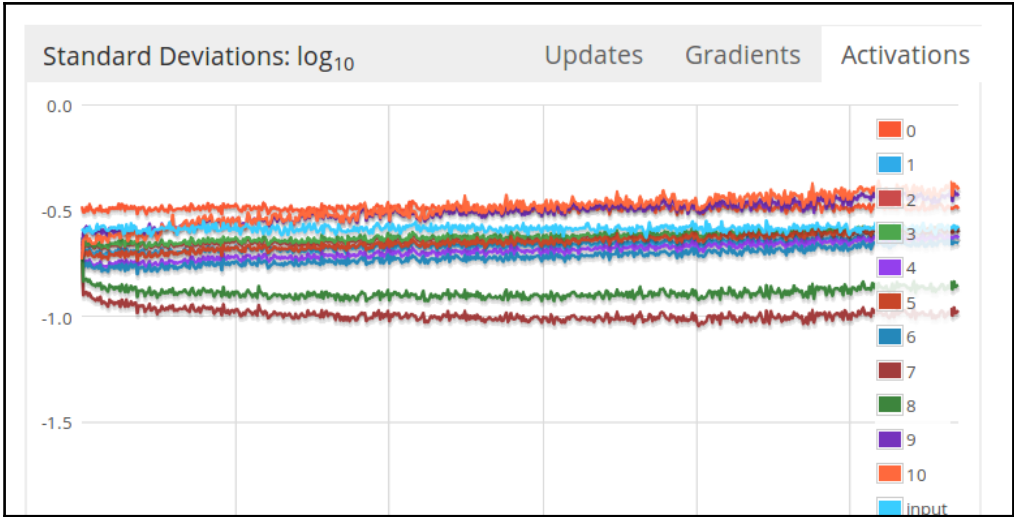

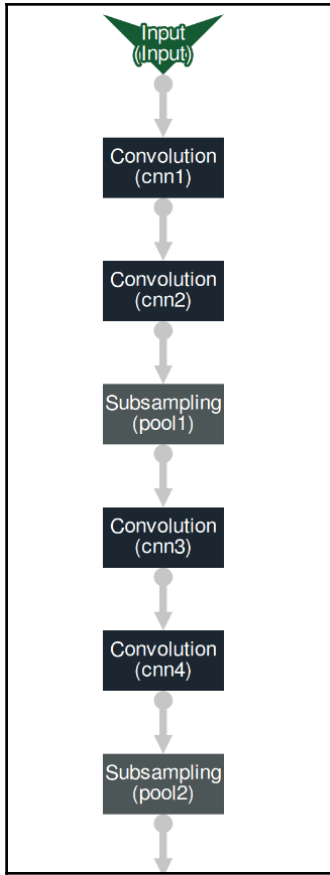



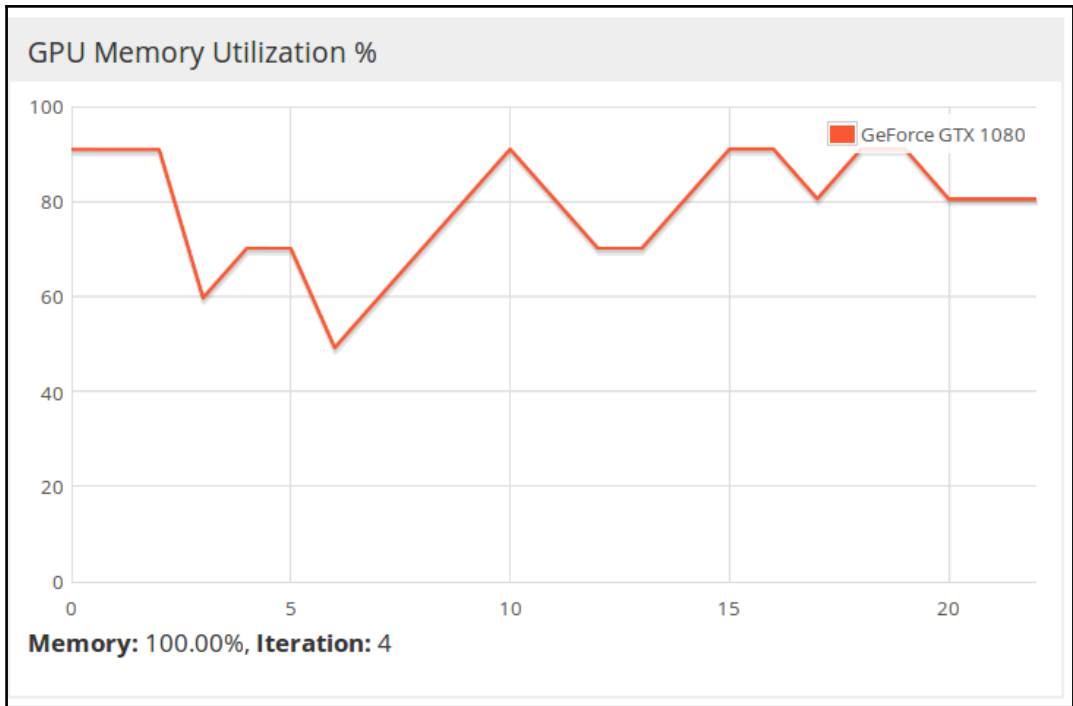

Chapter 9: Scaling Data Science

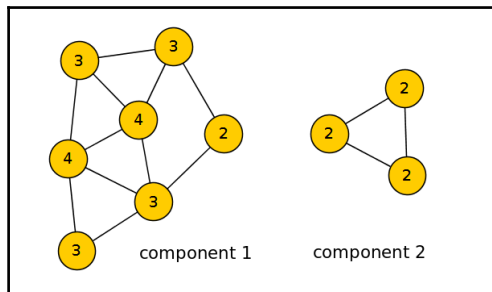

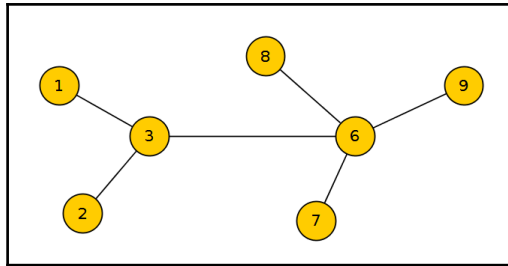
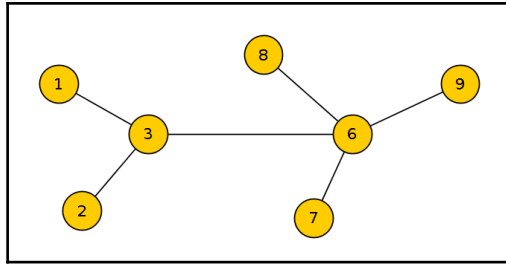

Chapter 10: Deploying Data Science Models

```
http://localhost:8080/q/cheap%20used%20cars - Mozilla Firefox
http://localhost:8080/...
localhost:8080/q/cheap used cars
[
  {
    url: http://www.carseek.com/used-car-dealers/nebraska/hayes-center/,
    title: "Cheap Used Cars in Hayes Center, NE"
  },
  {
    url: http://cars.oodle.com/audi/indianapolis-area/sedans/,
    title: "Audi Sedans for Sale in Indianapolis | Used Cars on Oodle Marketplace"
  },
  {
    url: http://cars.oodle.com/dodge/sedalia-mo/,
    title: "Dodge Cars for Sale in Sedalia, Missouri | Used Cars on Oodle Marketplace"
  },
  {
    url: http://www.autotrader.co.uk/used-cars/uk/london/merton/wimbledon/makes/coleman-milne,
    title: "Used Coleman Milne Wimbledon - Find a used Coleman Milne for sale in Wimbledon | Auto Trader"
  },
  {
    url: http://cars.oodle.com/used-cars/springfield-mo-area/features_cruise_control/?o=30&s=date,
    title: "Page 3: Cars for Sale in Springfield, MO with Cruise Control | Used Cars on Oodle Marketplace"
  },
  {
    url: http://www.autotrader.co.uk/used-cars/uk/west-midlands/warwickshire/studley/makes/infiniti,
    title: "Used Infiniti Studley - Find a used Infiniti for sale in Studley | Auto Trader"
  }
]
```