

# 1

## Chapter 01: Relational Databases

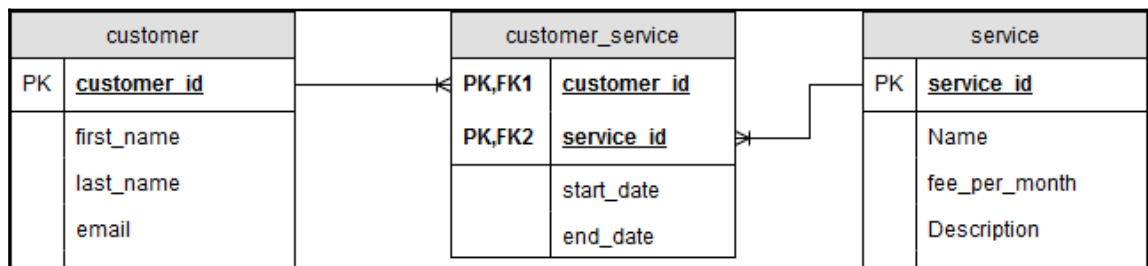

customer_id	first_name	las_name		customer_service_id	customer_id	start_date	end_date	
1	thomas	sieh	X	1	1	2017-11-01	2018-11-01	=
2	wang	kim		2	1	2017-11-01	2018-11-01	

customer_id	first_name	las_name	customer_service_id	customer_id	start_date	end_date
1	thomas	sieh	1	1	2017-11-01	2018-11-01
2	wang	kim	1	1	2017-11-01	2018-11-01
1	thomas	sieh	2	1	2017-11-01	2018-11-01
2	wang	kim	2	1	2017-11-01	2018-11-01



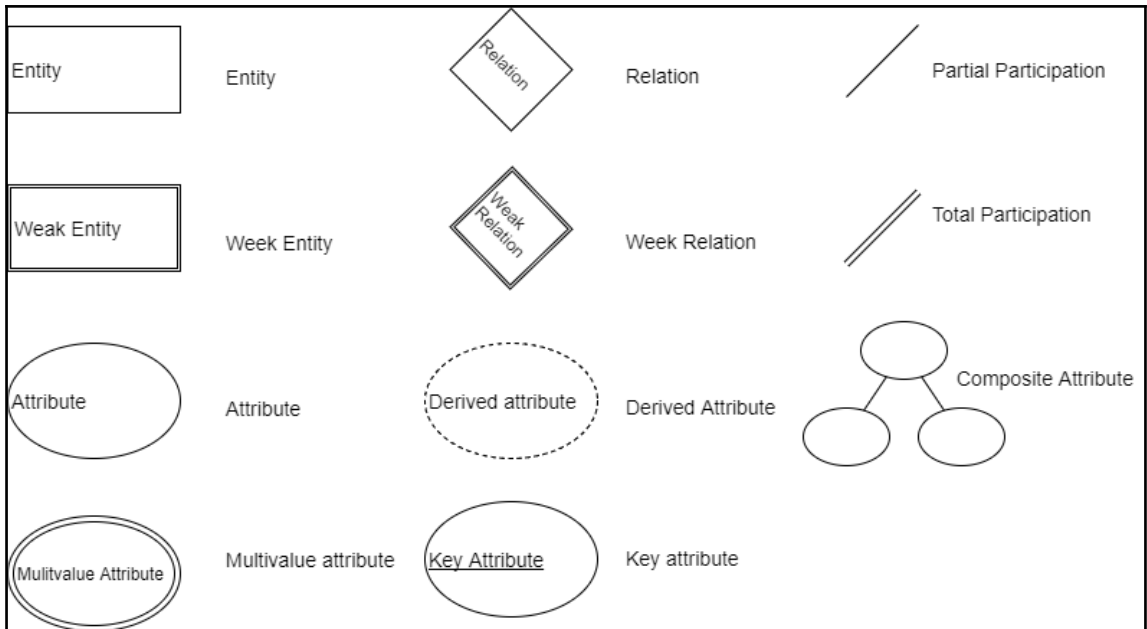

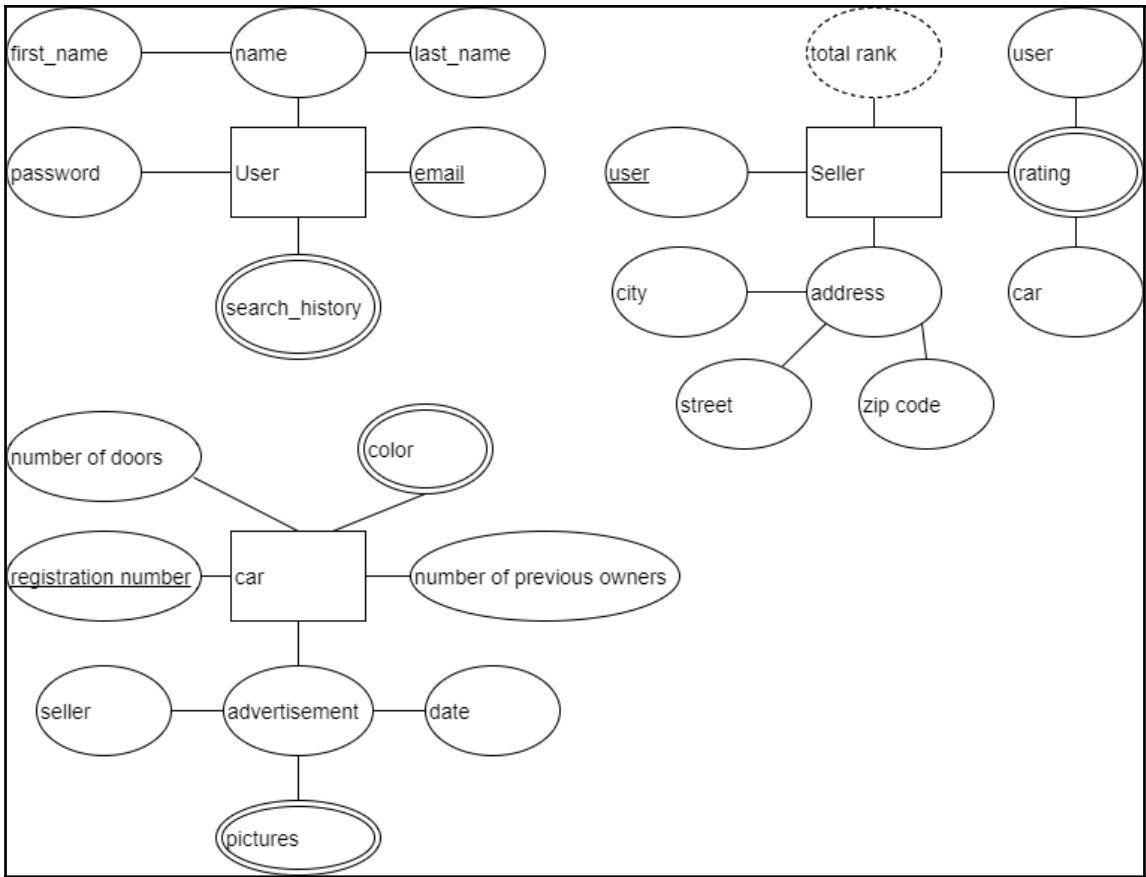

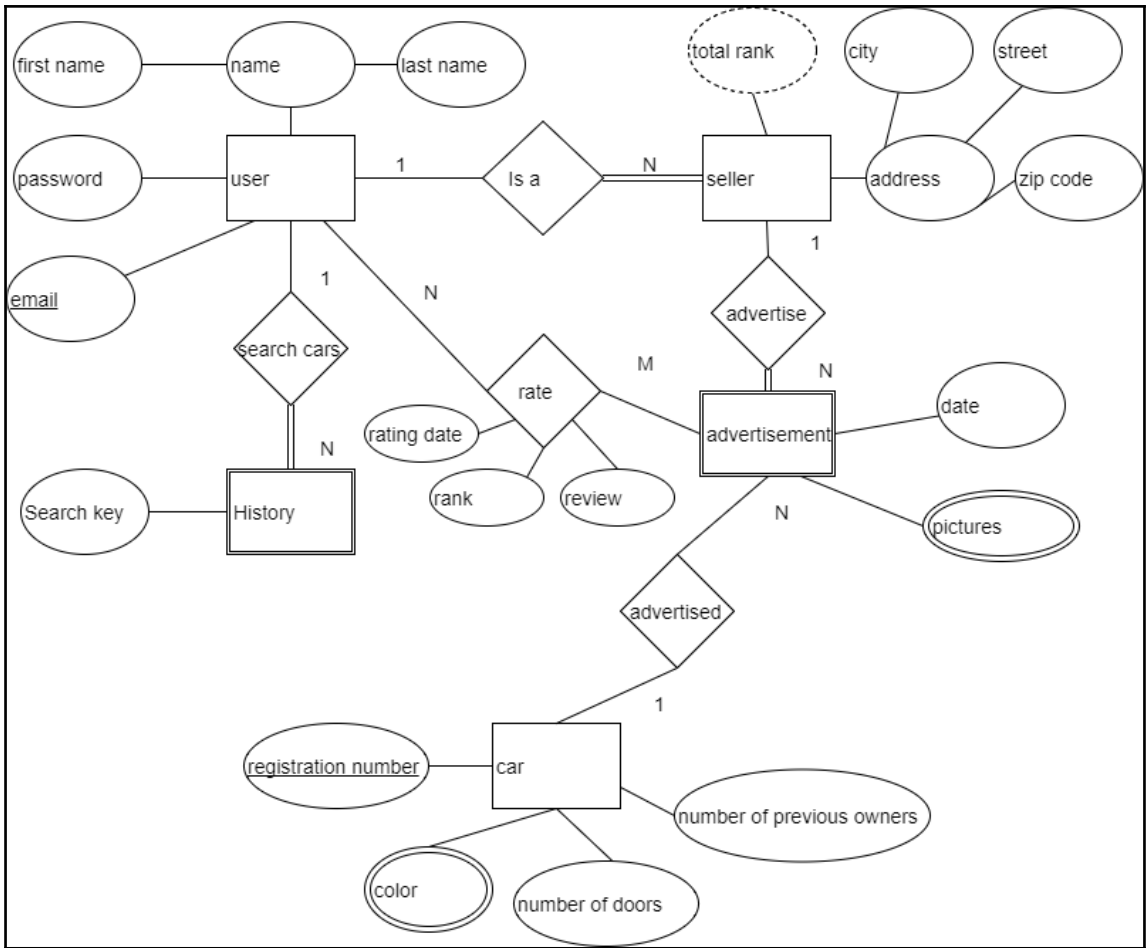
# Chapter 02: PostgreSQL in Action

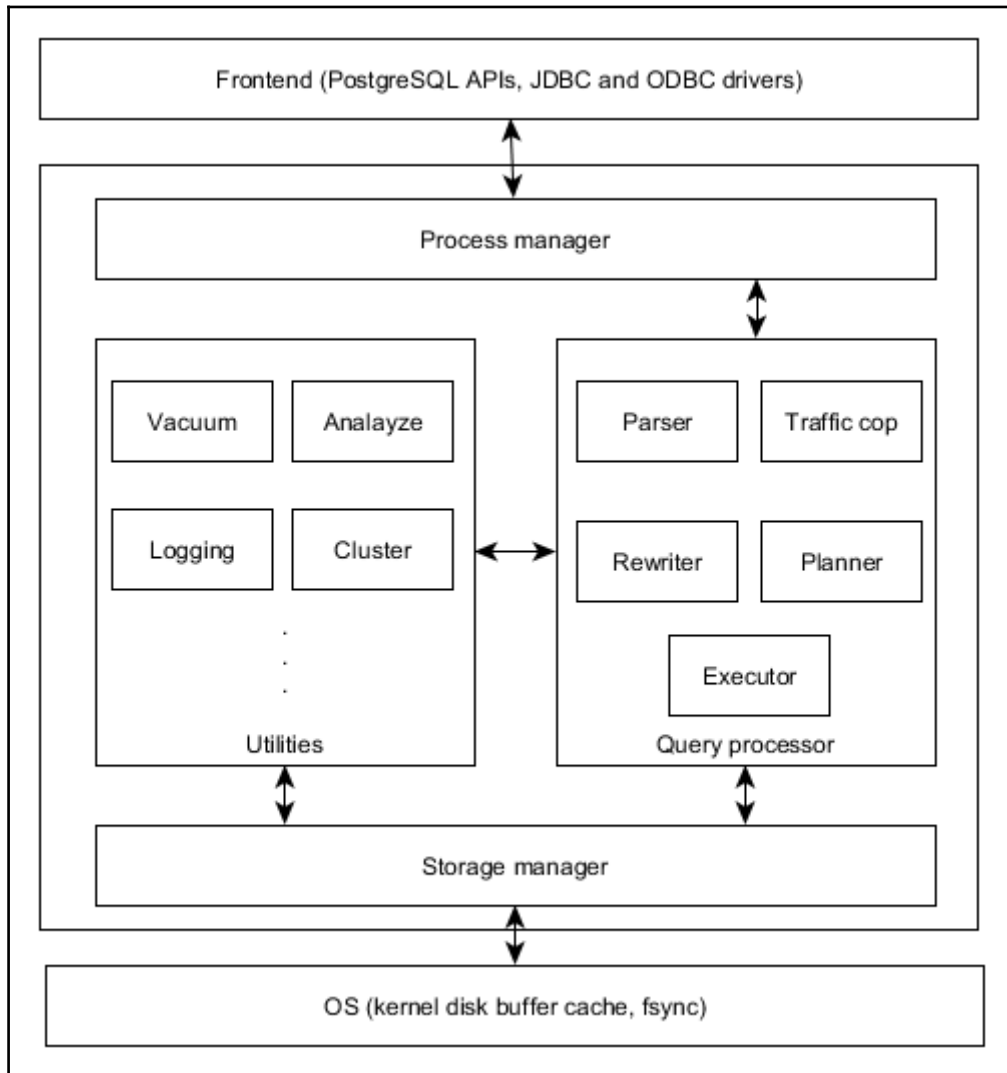

To use the apt repository, follow these steps:

- ▾
- Create the file `/etc/apt/sources.list.d/pgdg.list`, and add a line for the repository

```
deb http://apt.postgresql.org/pub/repos/apt/ zesty-pgdg main
```

- Import the repository signing key, and update the package lists

```
wget --quiet -O - https://www.postgresql.org/media/keys/ACCC4CF8.asc | \  
sudo apt-key add - \  
sudo apt-get update
```

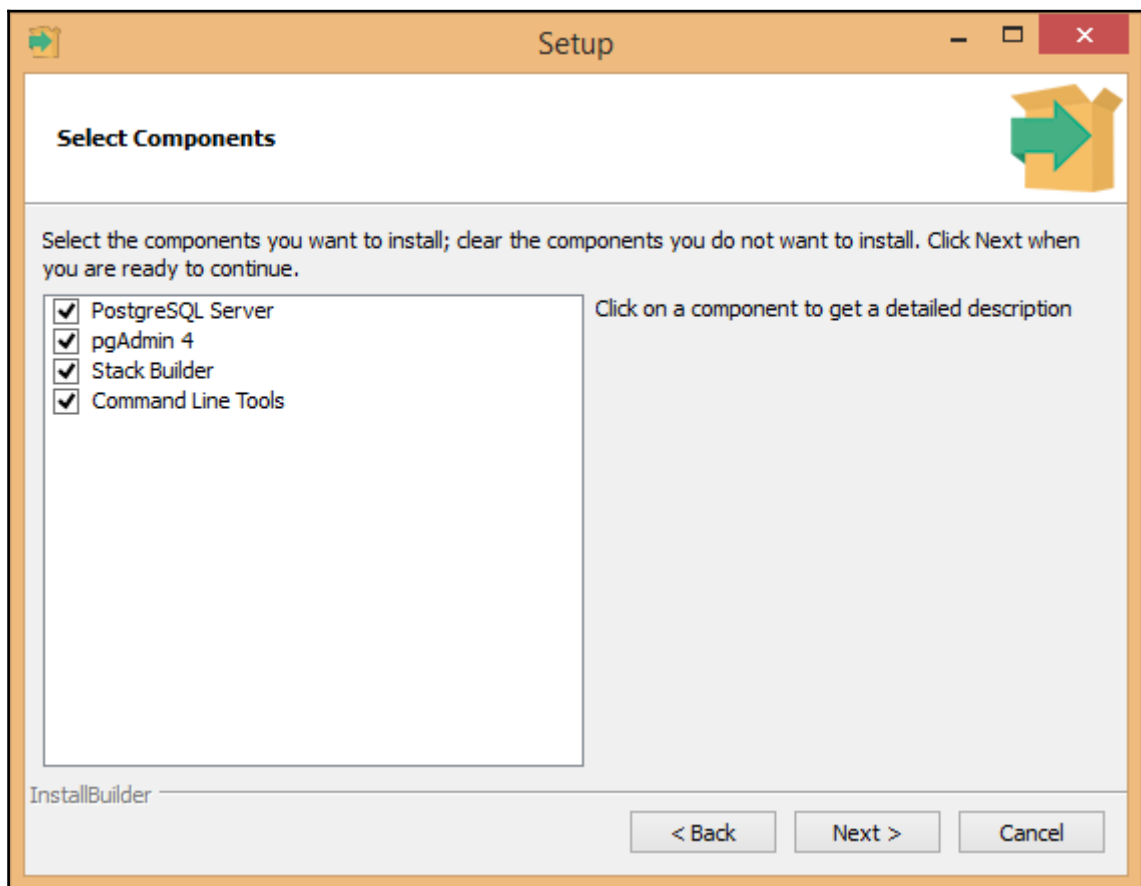

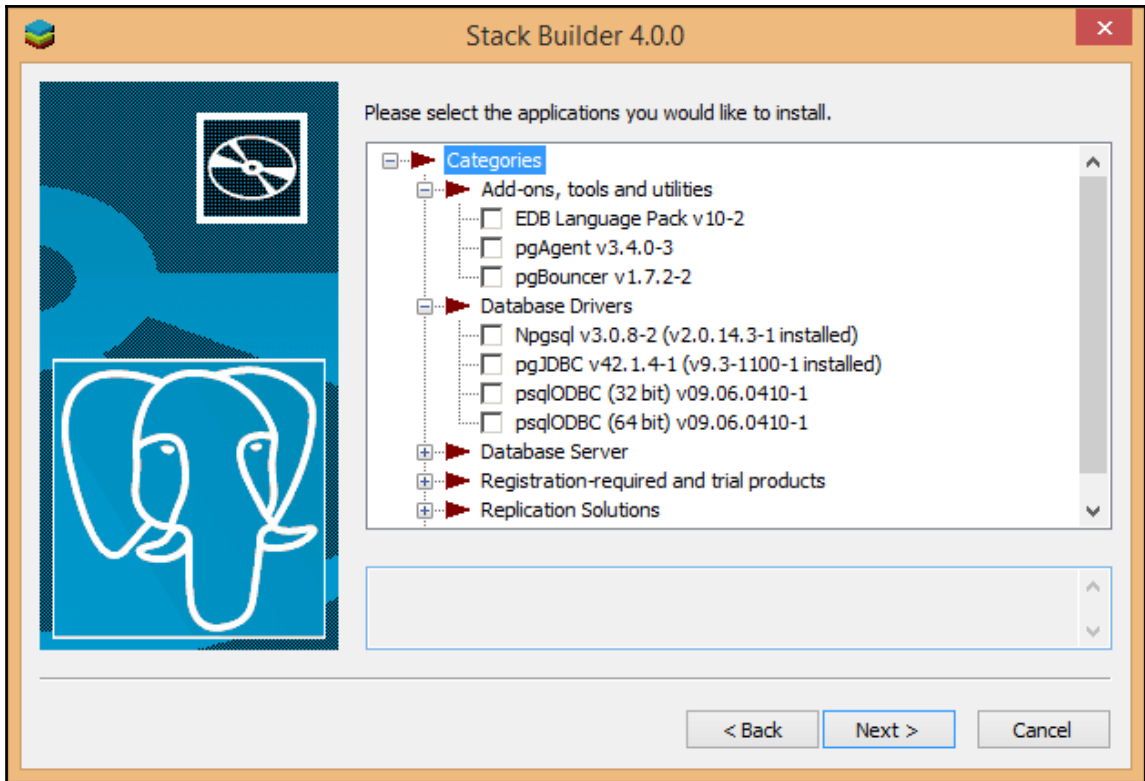

# Chapter 03: PostgreSQL Basic Building Blocks

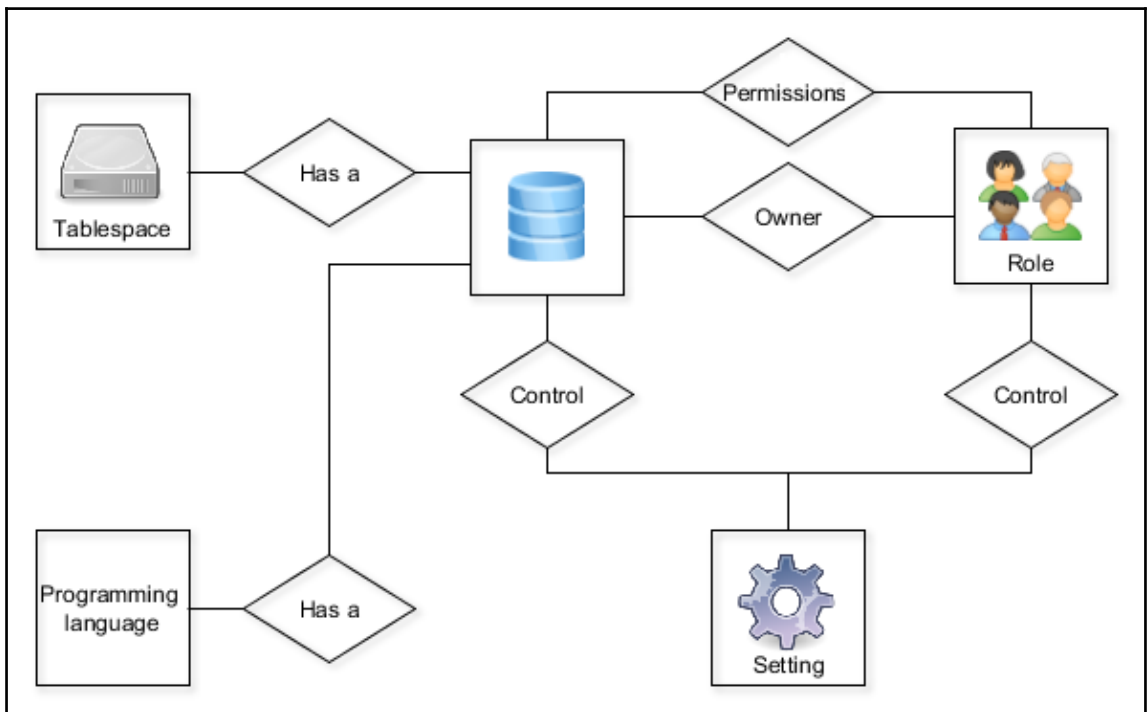
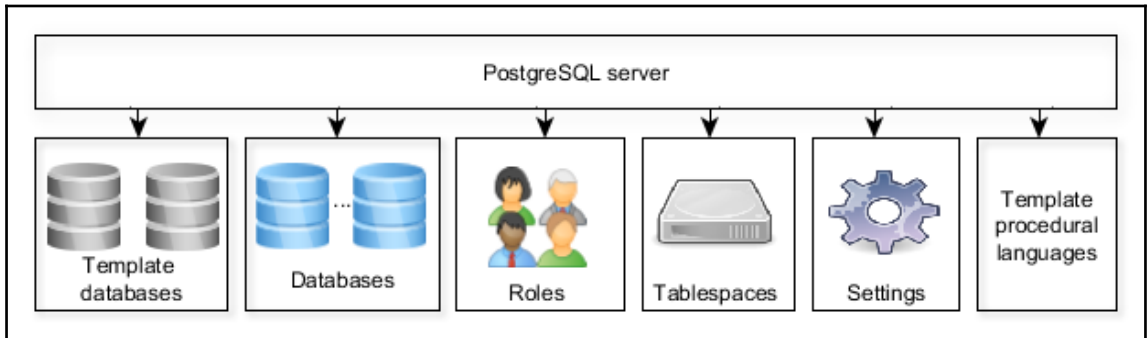



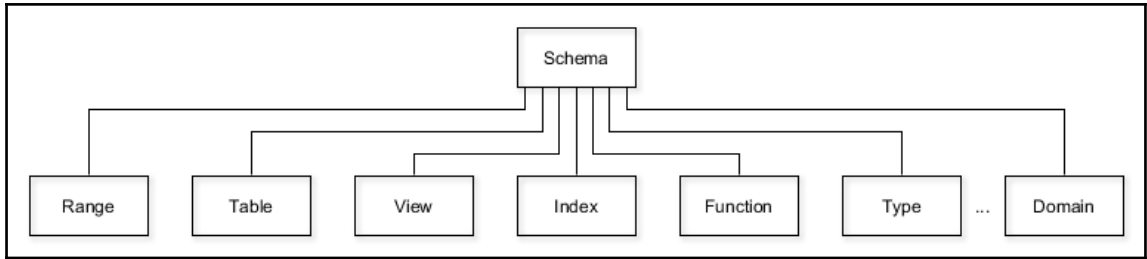

---

## Chapter 05: SQL Language

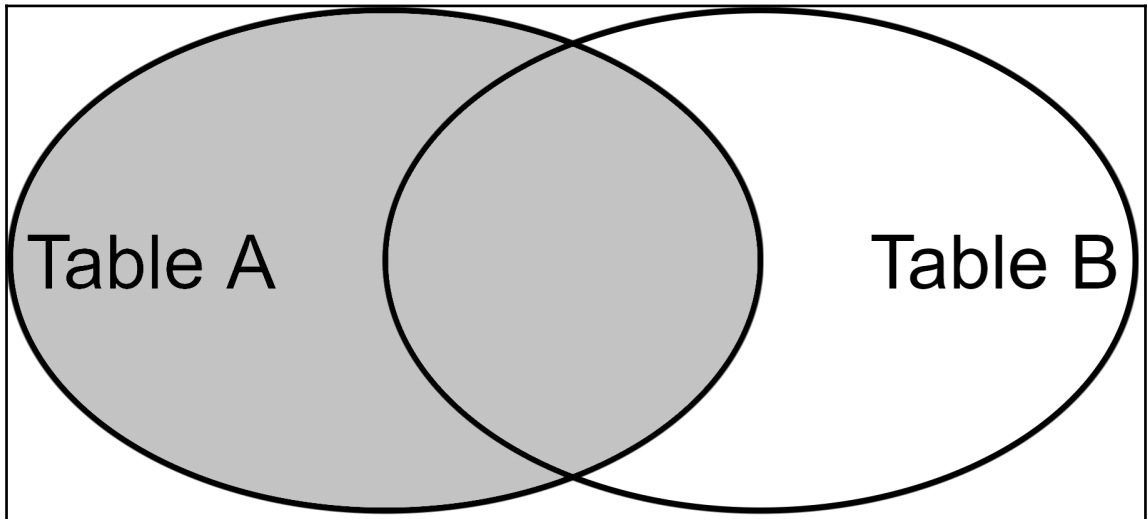
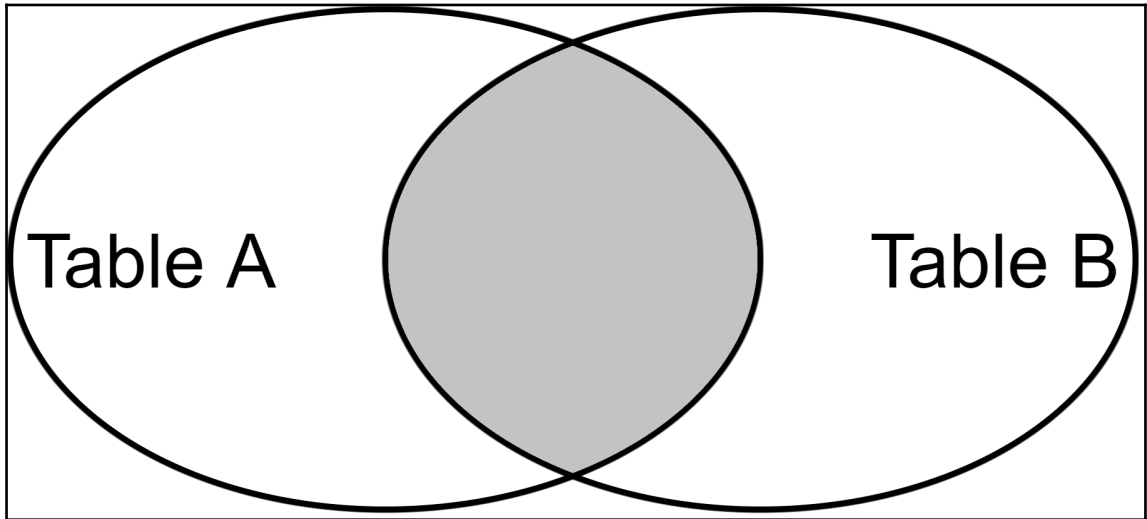

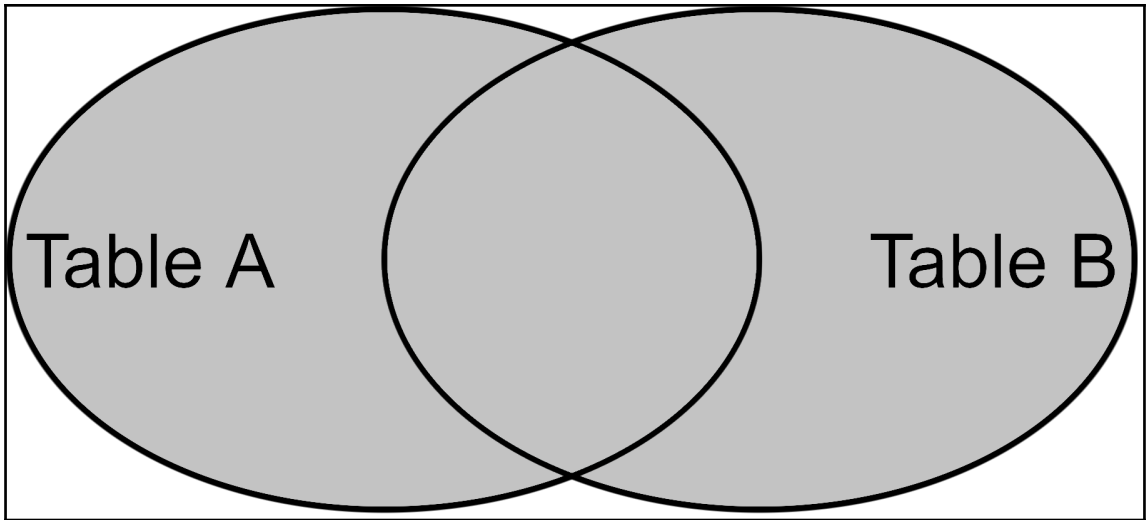
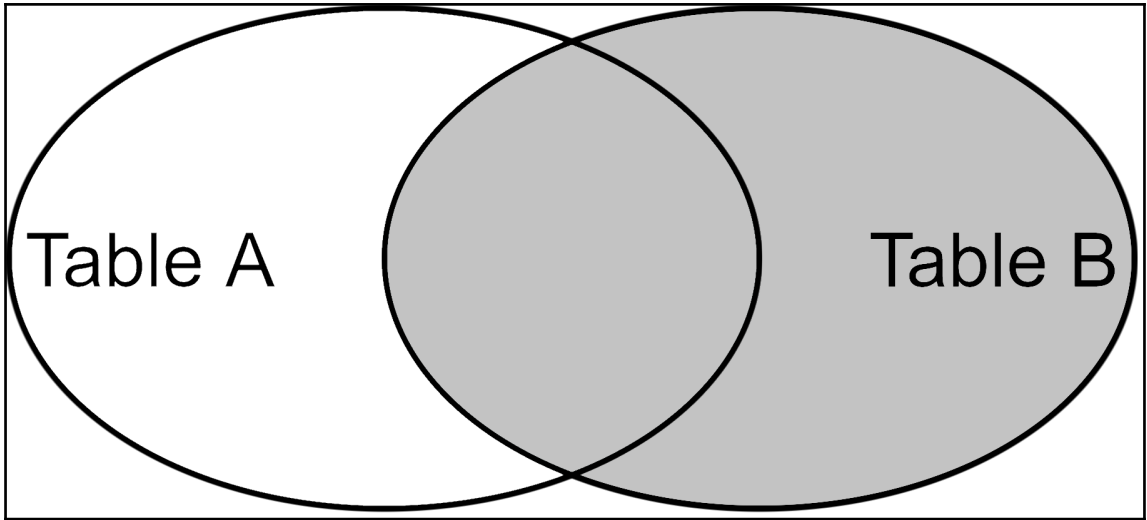

# Chapter 06: Advanced Query Writing

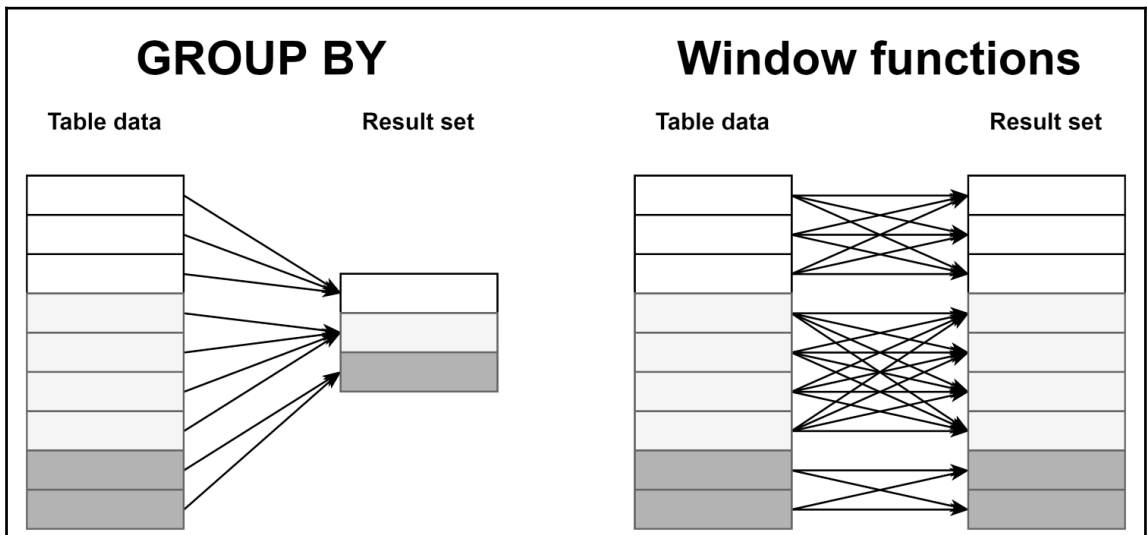
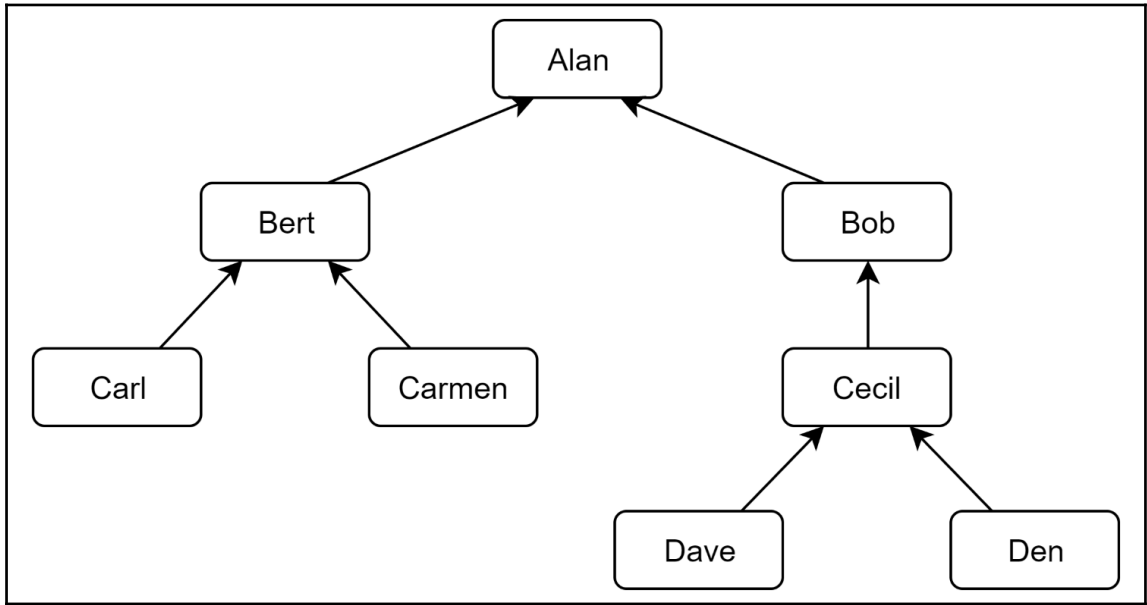

# Chapter 08: OLAP and Data Warehousing

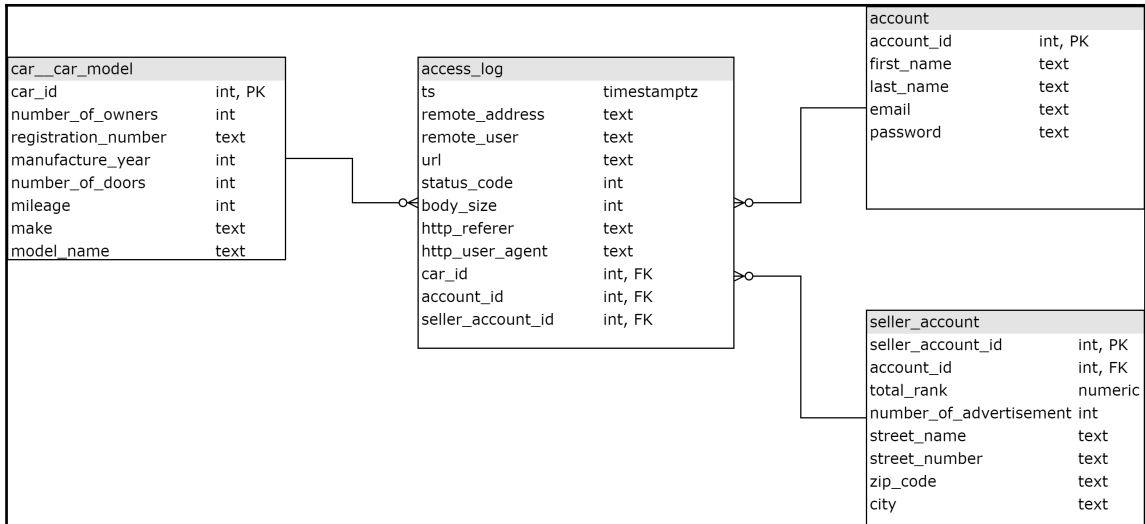
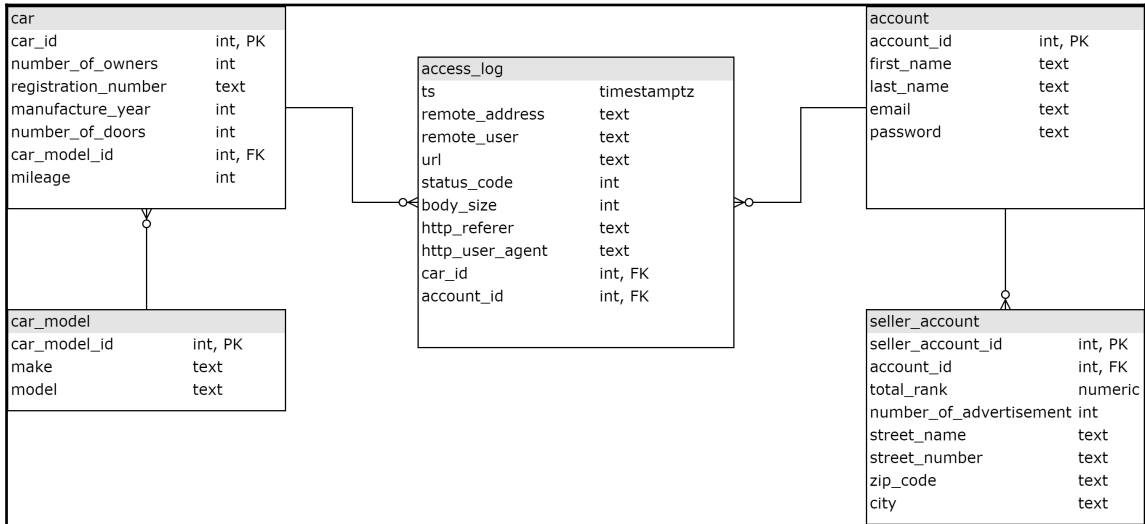

# Chapter 10: Transactions and Concurrency Control

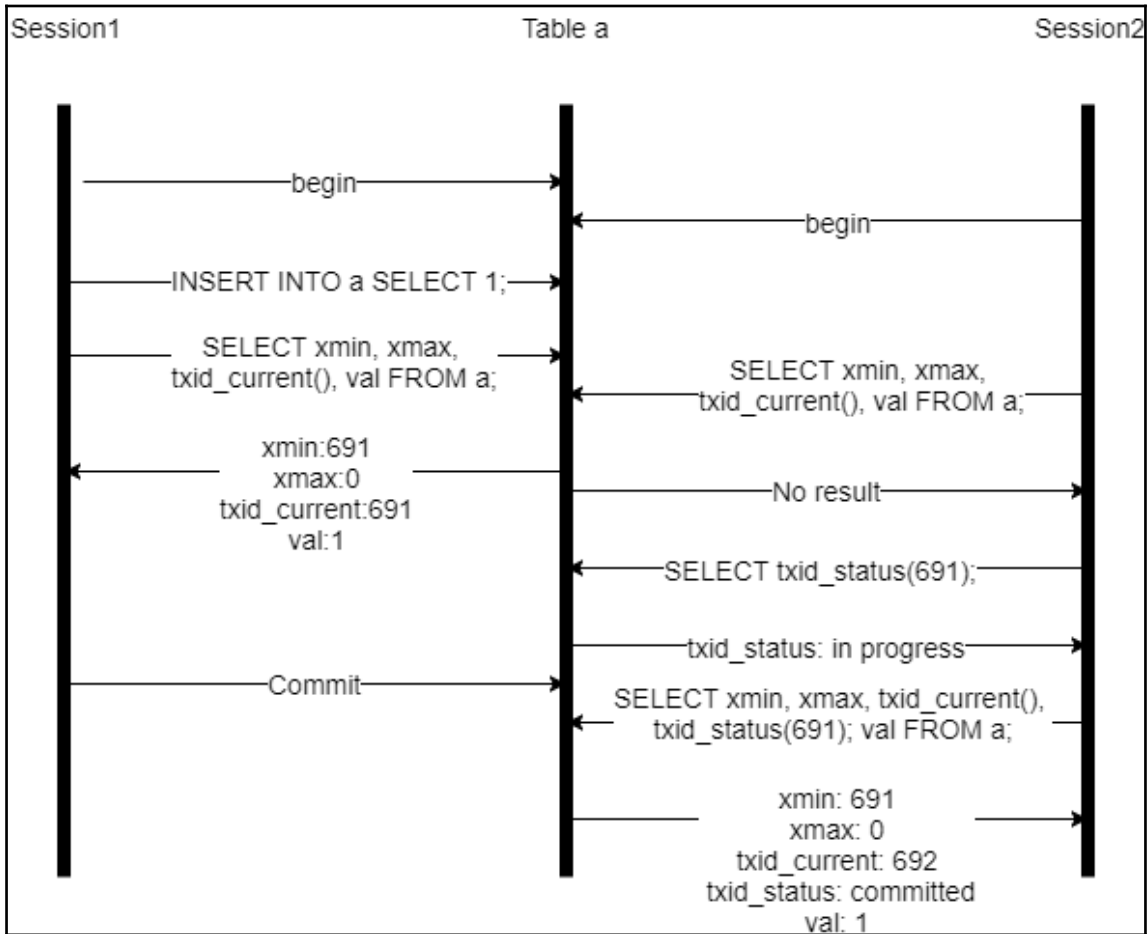

Conflicting?	ACCESS SHARE	ROW SHARE	ROW EXCLUSIVE	SHARE UPDATE EXCLUSIVE	SHARE	SHARE ROW EXCLUSIVE	EXCLUSIVE	ACCESS EXCLUSIVE
ACCESS SHARE								yes
ROW SHARE							yes	yes
ROW EXCLUSIVE					yes	yes	yes	yes
SHARE UPDATE EXCLUSIVE				yes	yes	yes	yes	yes
SHARE			yes	yes	yes	yes	yes	yes
SHARE ROW EXCLUSIVE			yes	yes	yes	yes	yes	yes
EXCLUSIVE		yes	yes	yes	yes	yes	yes	yes
ACCESS EXCLUSIVE	yes	yes	yes	yes	yes	yes	yes	yes

---

Conflicting?	FOR KEY SHARE	FOR SHARE	FOR NO KEY UPDATE	FOR UPDATE
FOR KEY SHARE				yes
FOR SHARE			yes	yes
FOR NO KEY UPDATE		yes	yes	yes
FOR UPDATE	yes	yes	yes	yes

# Chapter 12: The PostgreSQL Catalog

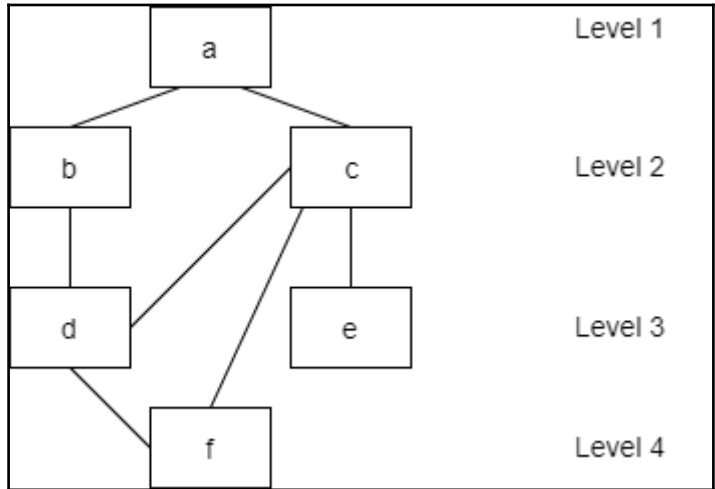



# Chapter 16: Scalability

