

Graphic Bundle

Chapter 1: Introduction to Deep Learning

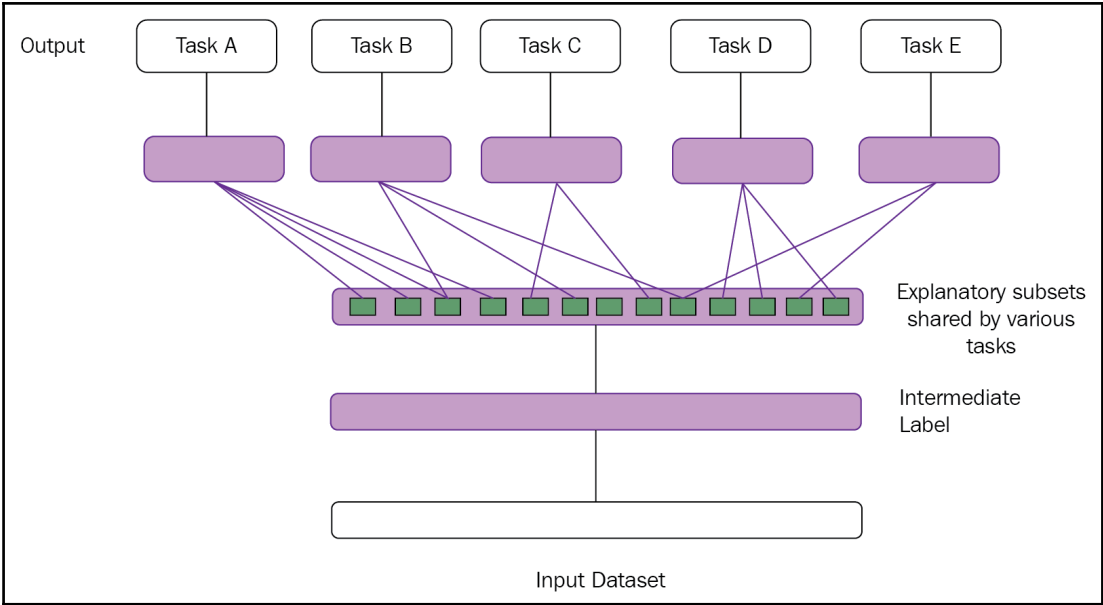

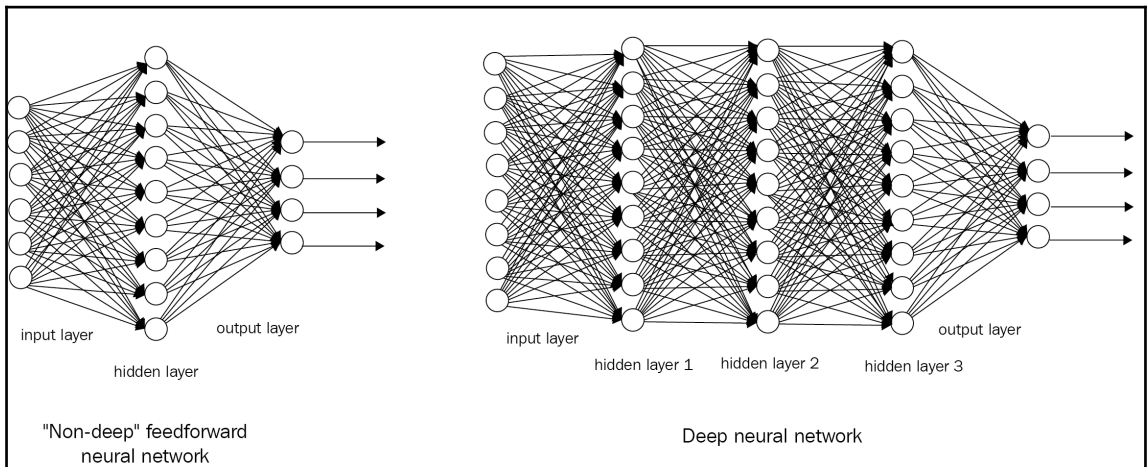

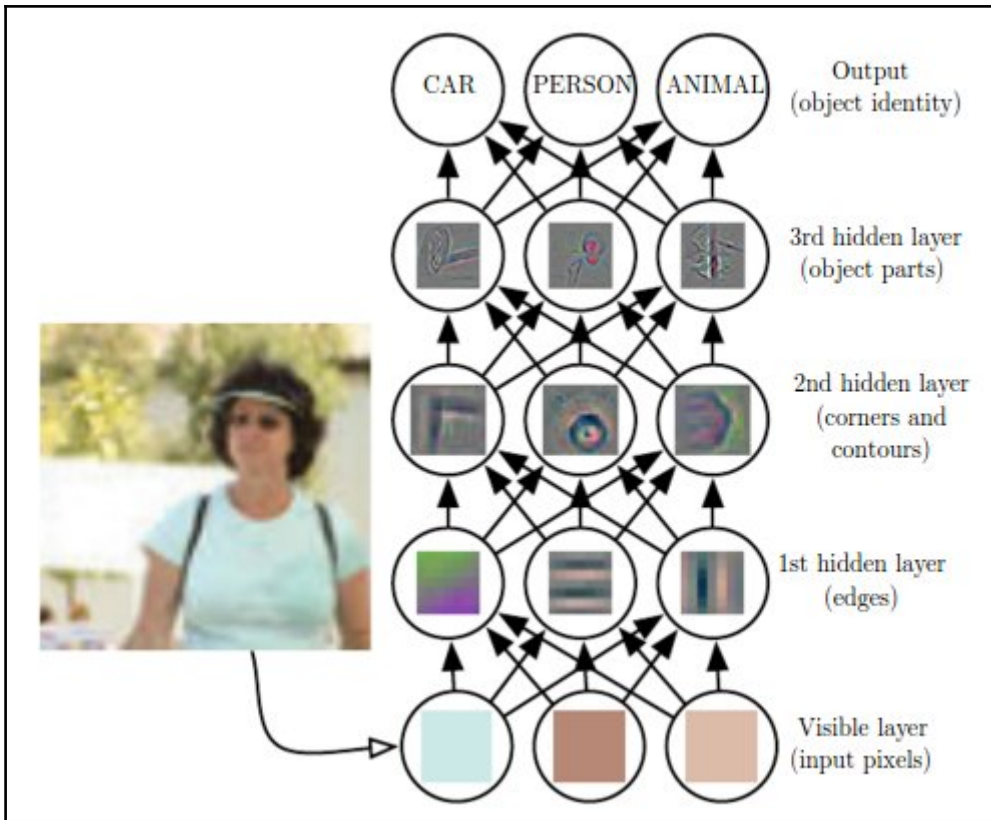

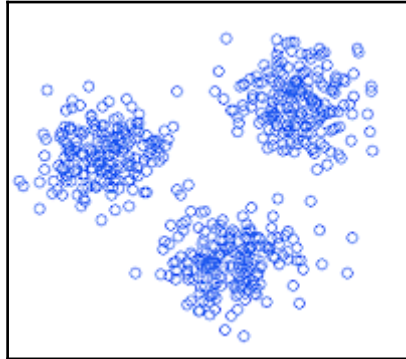

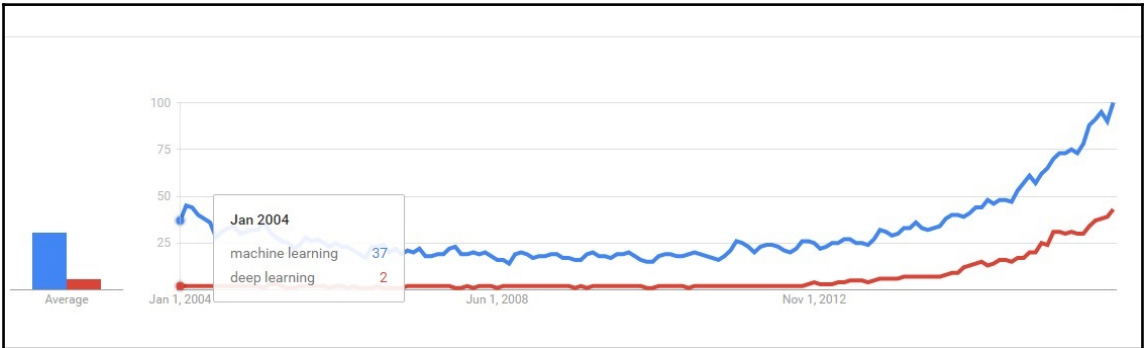
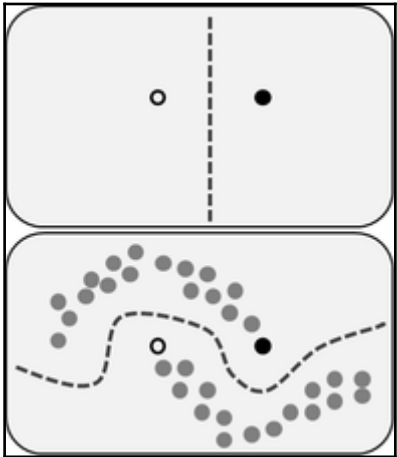
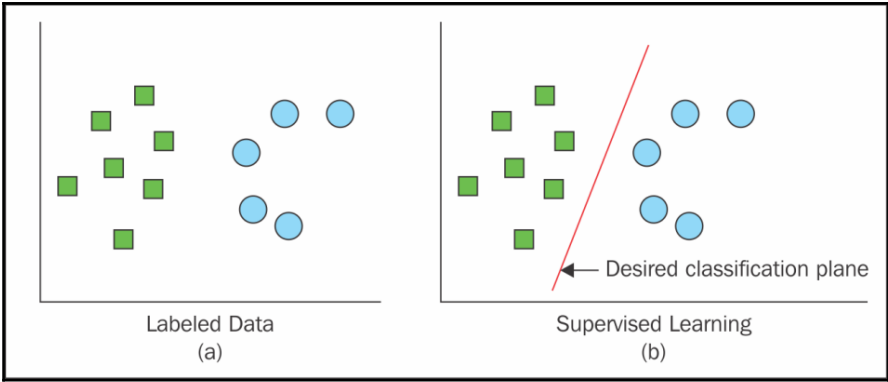

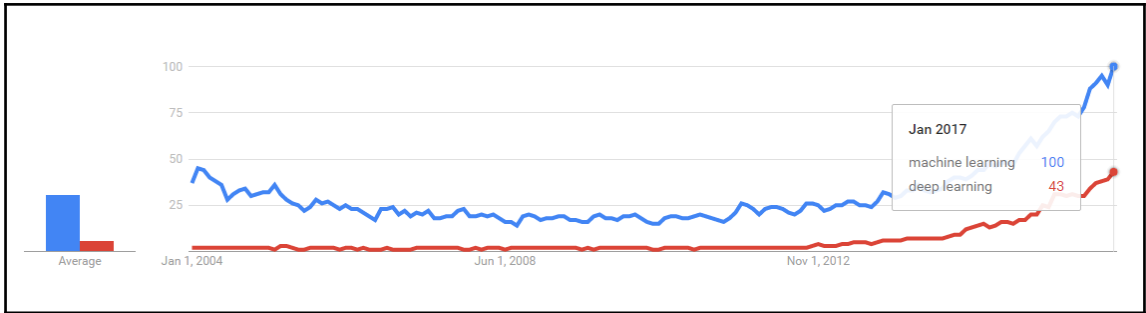

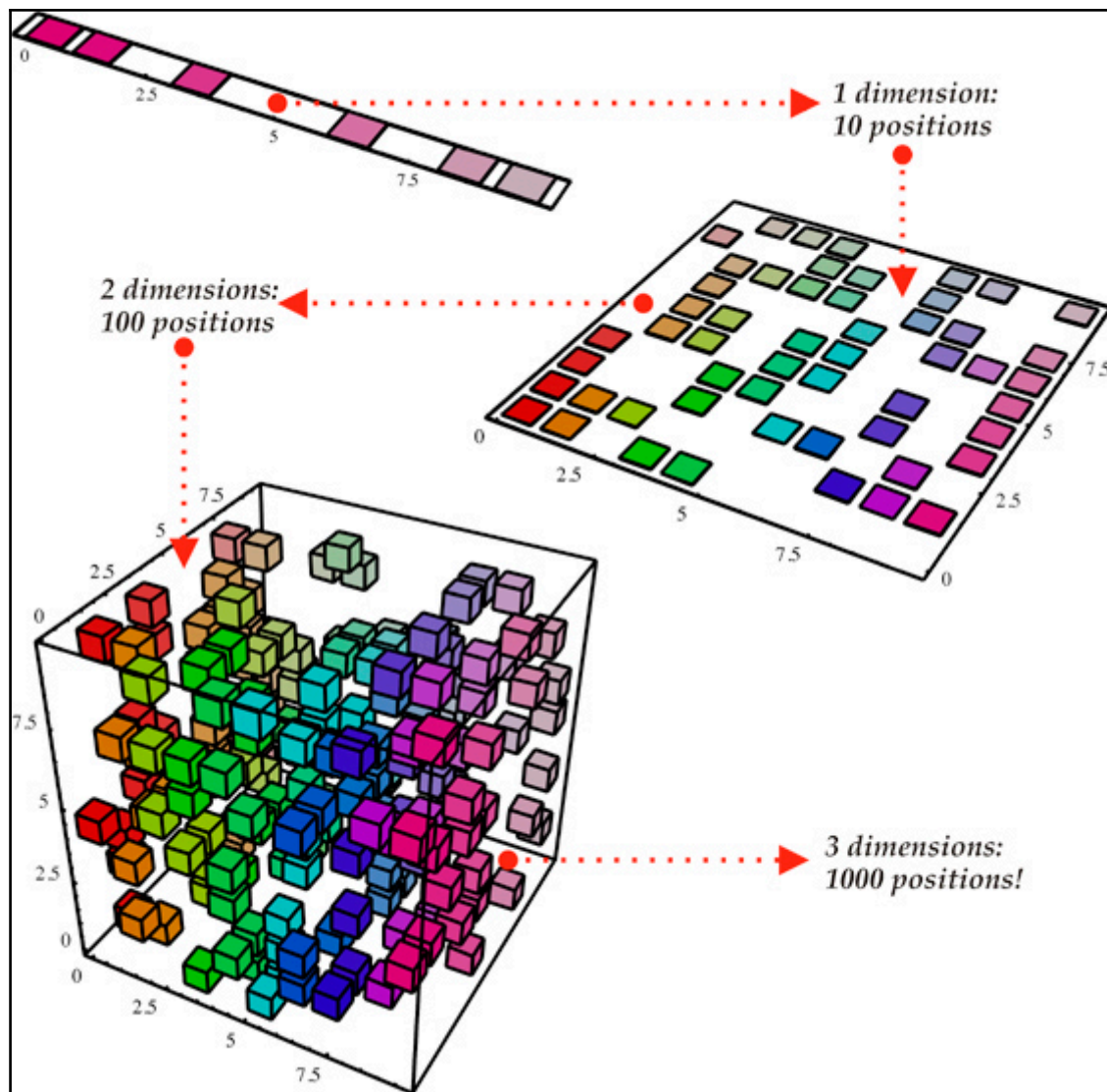

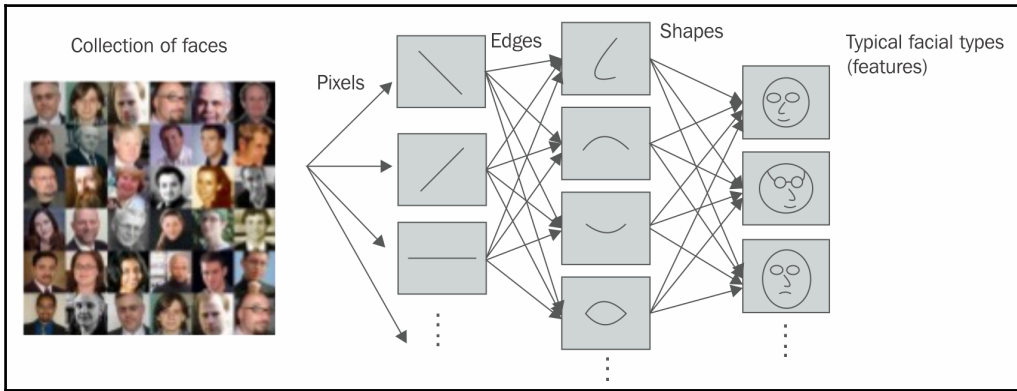
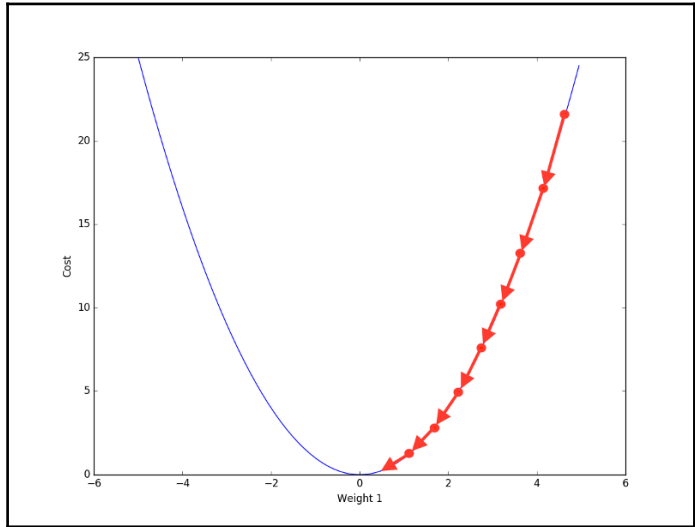
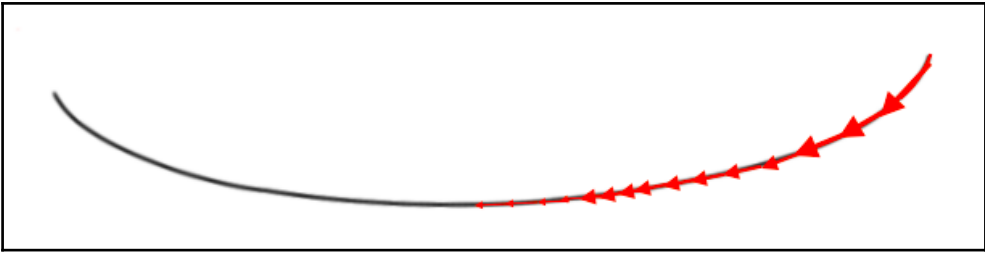

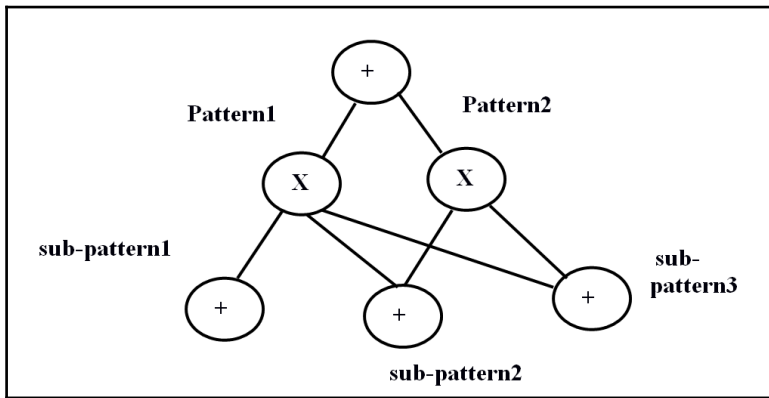
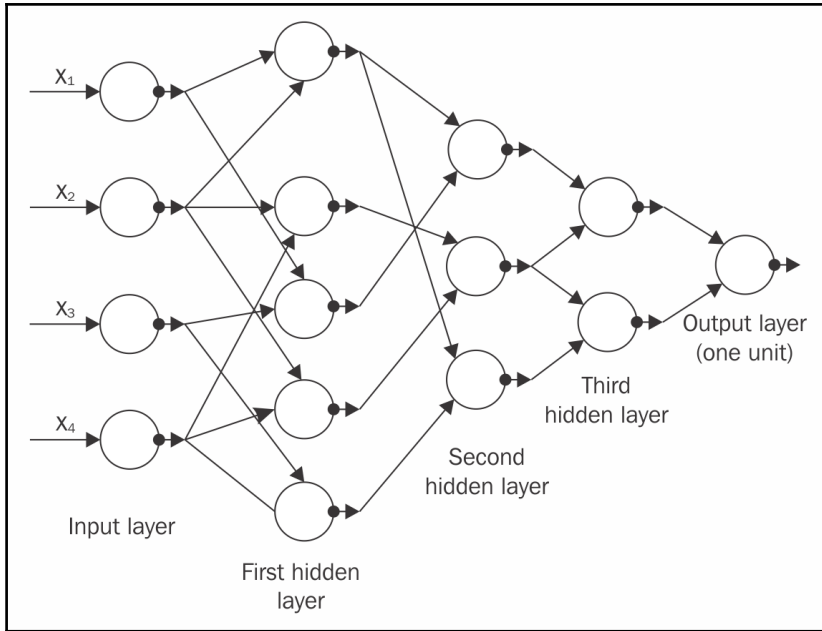

Chapter 2: Distributed Deep Learning for Large-Scale Data

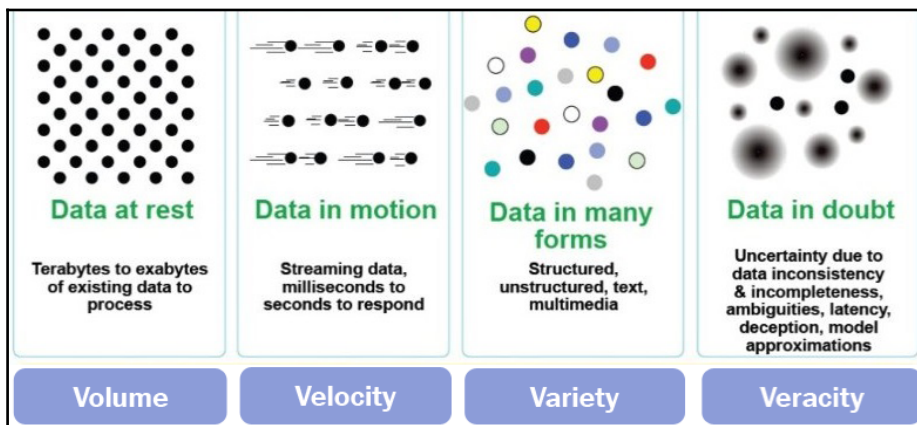
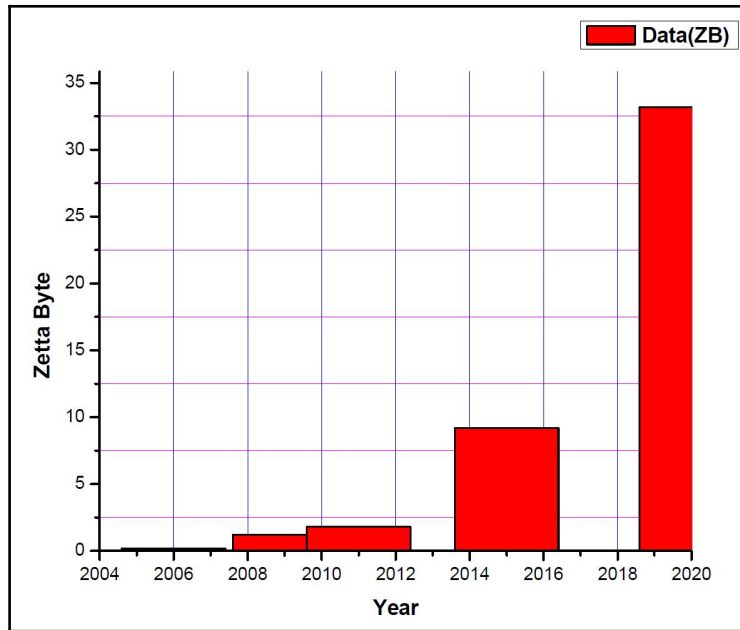

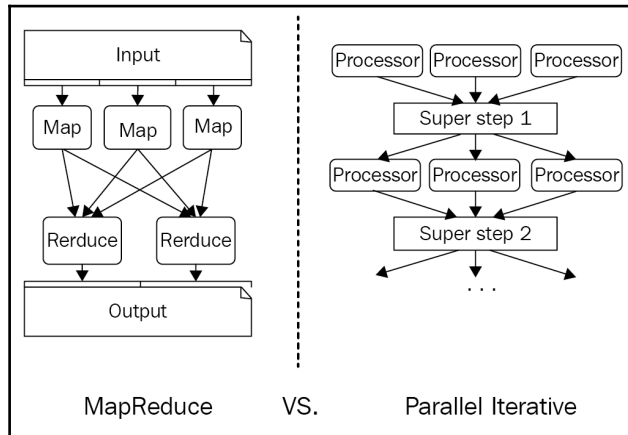
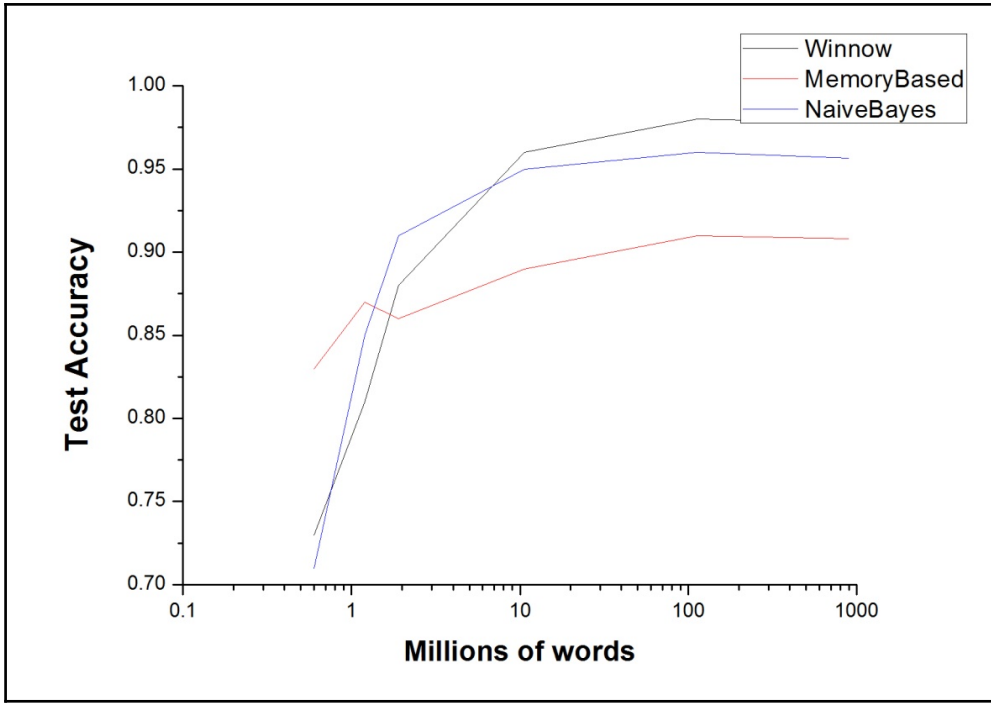

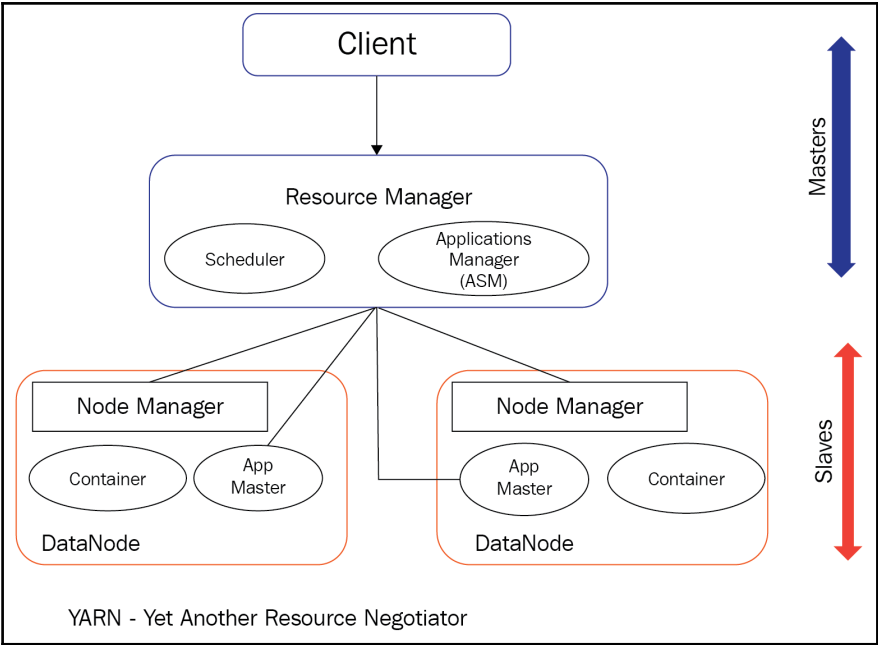

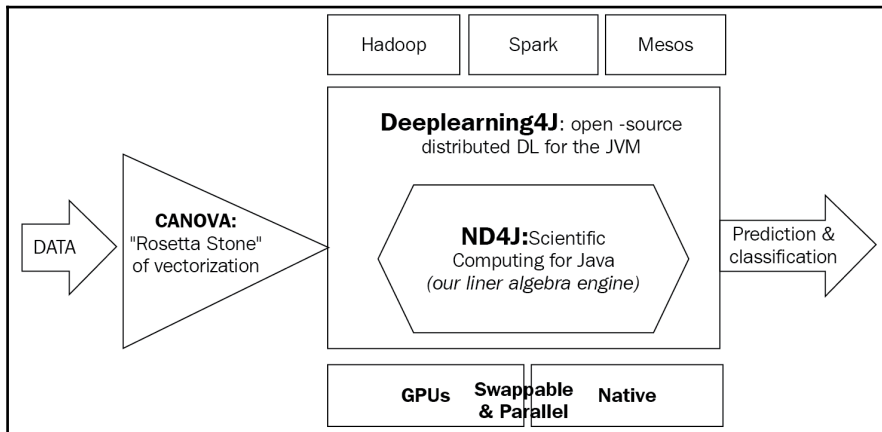
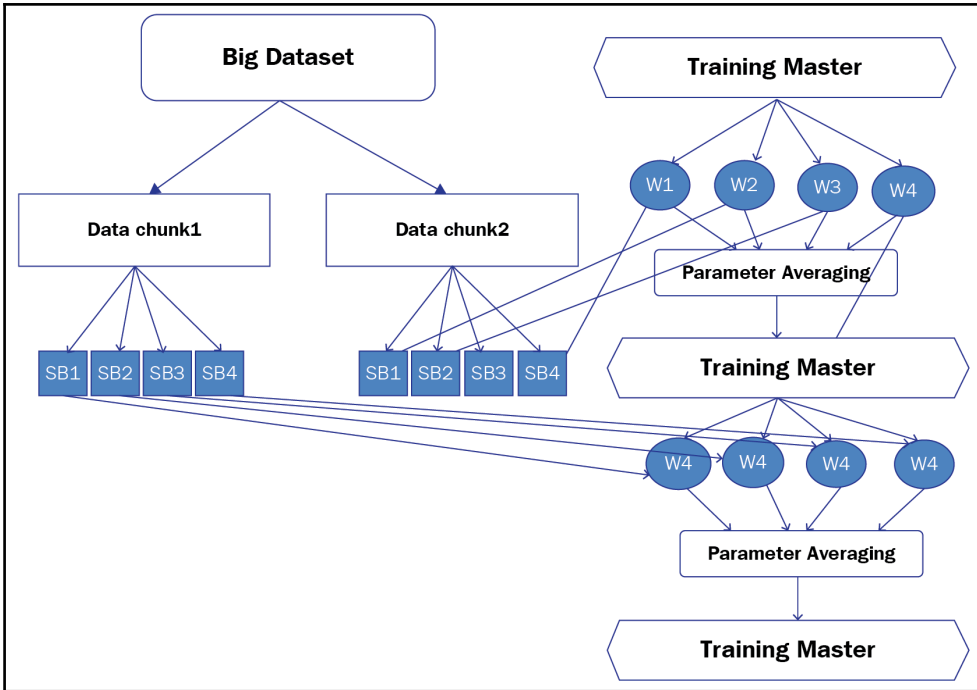

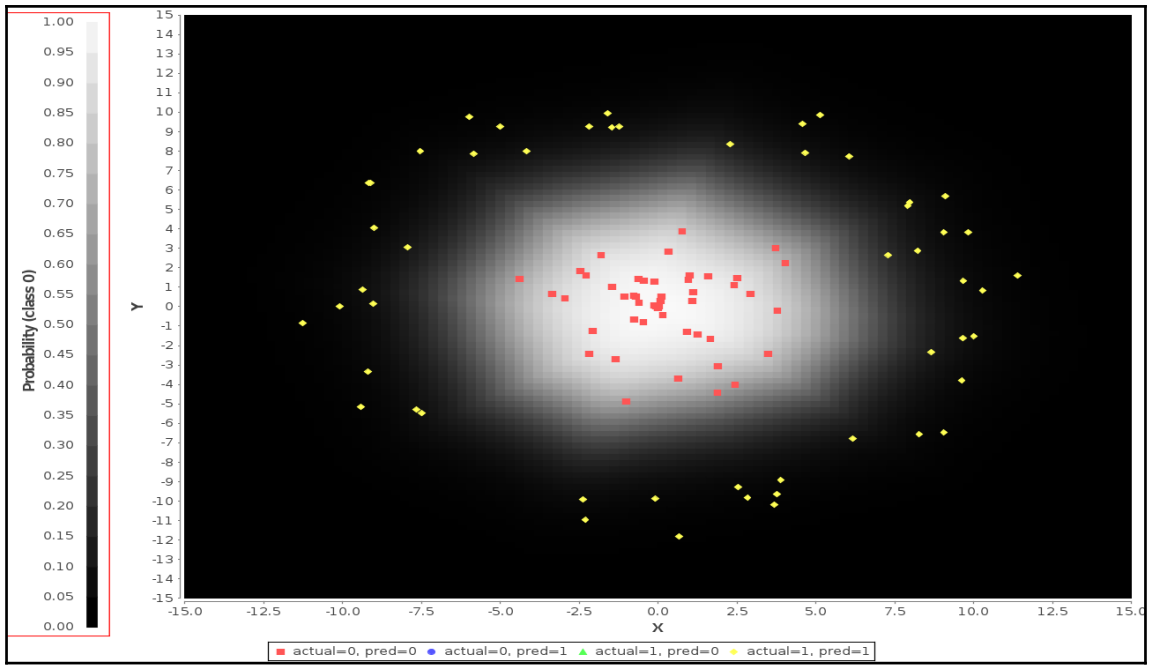

Chapter 3: Convolutional Neural Network

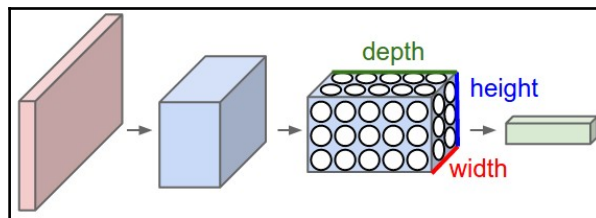
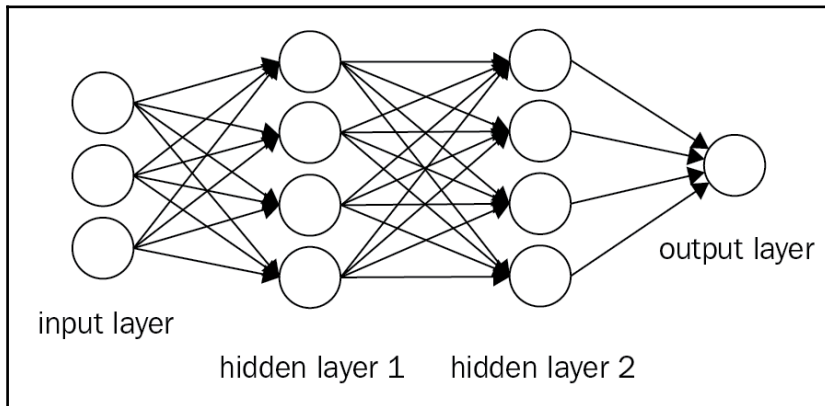
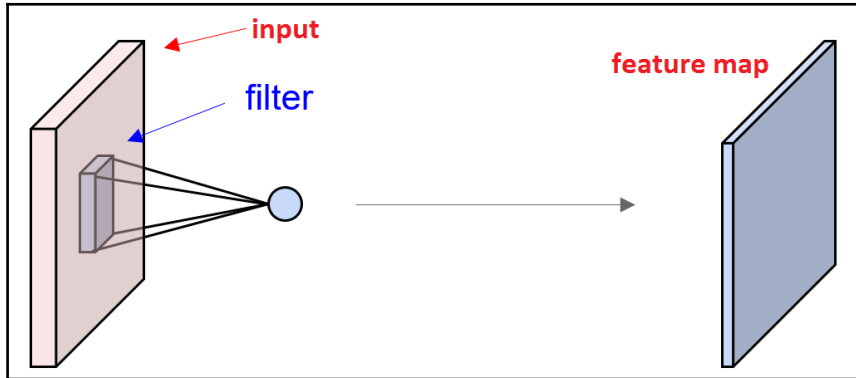

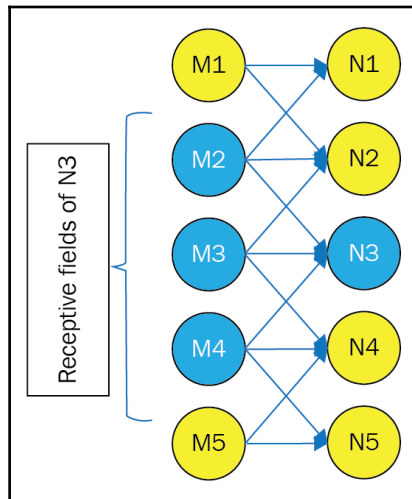
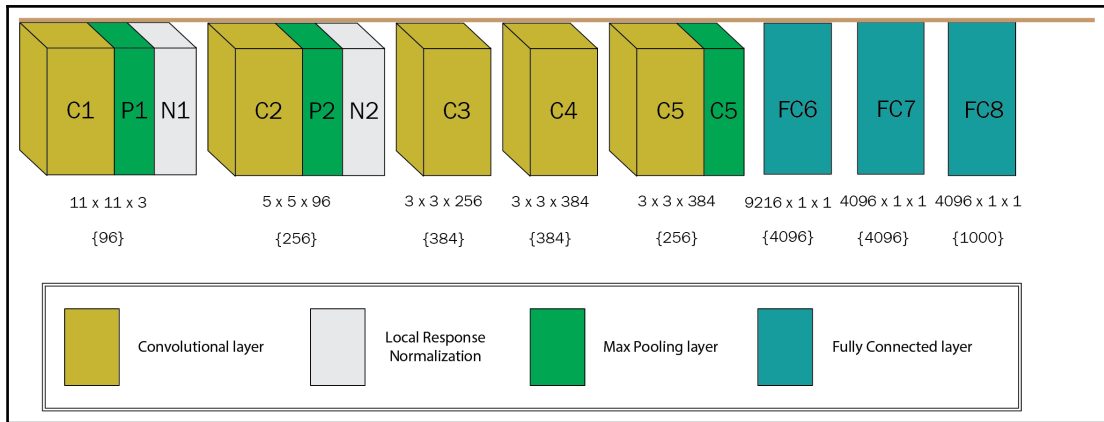

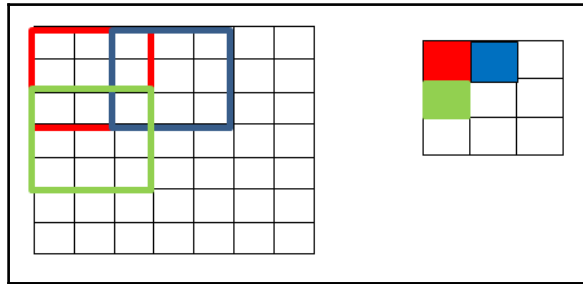
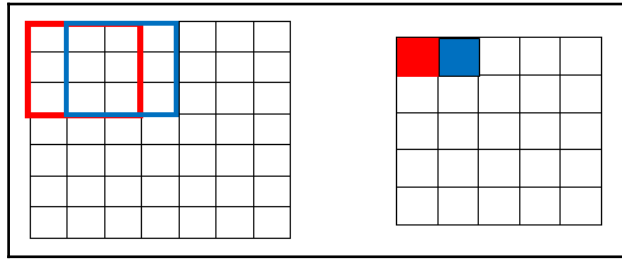
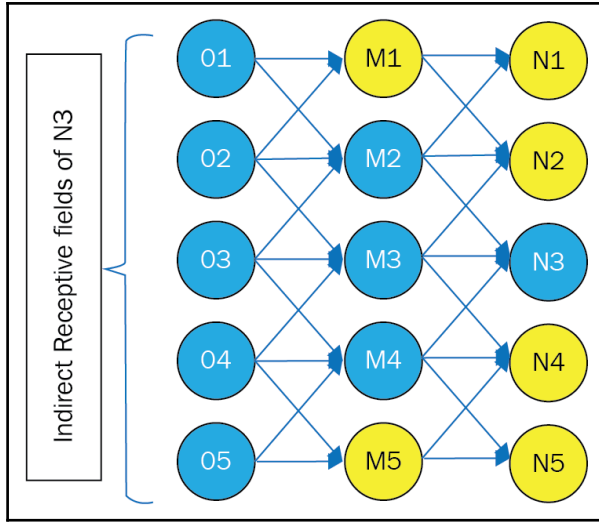

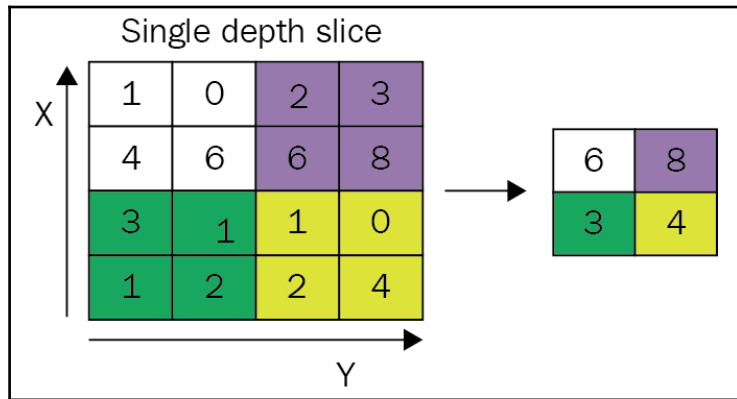
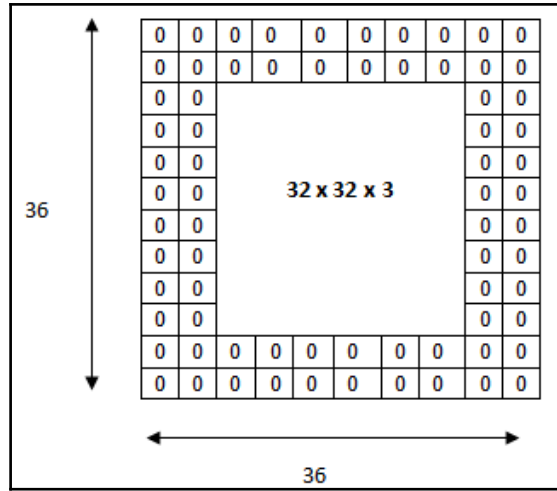

Chapter 4: Recurrent Neural Network

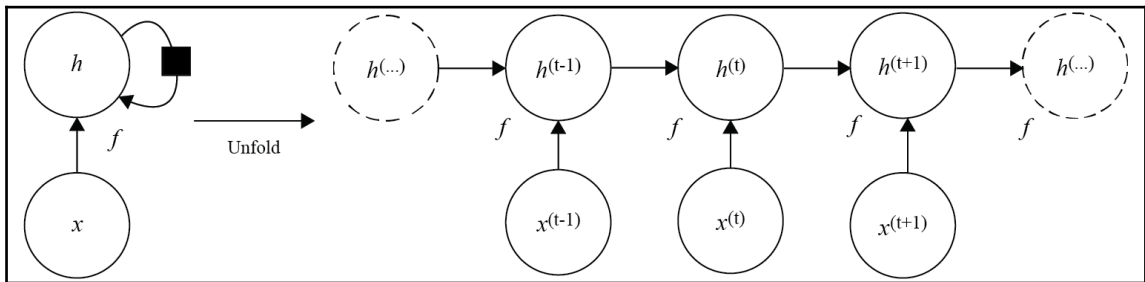
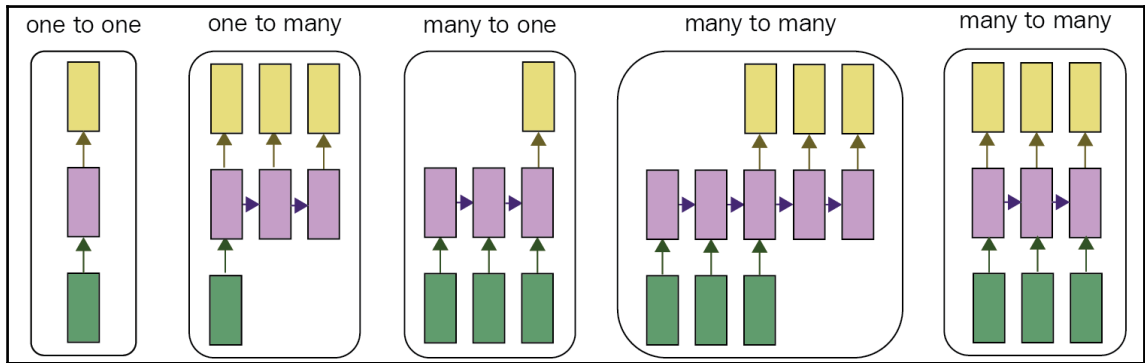

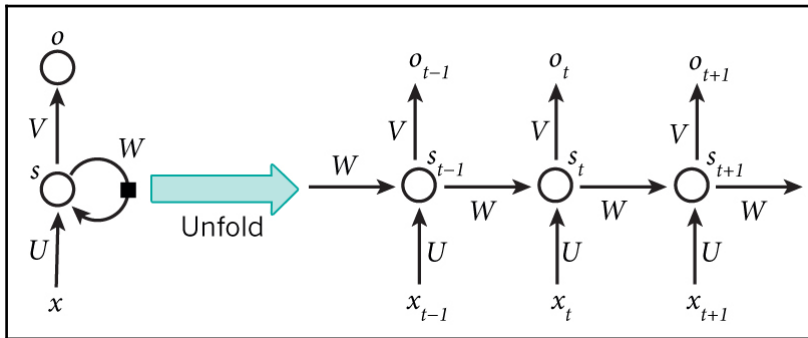
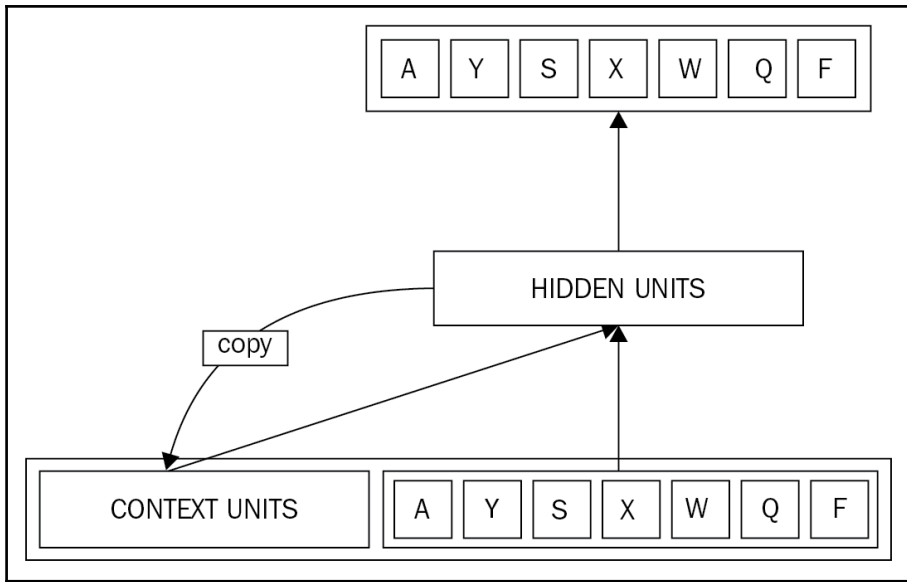

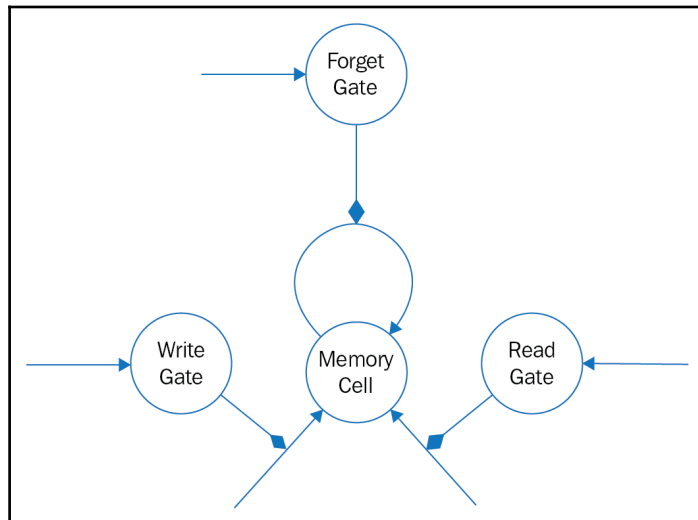
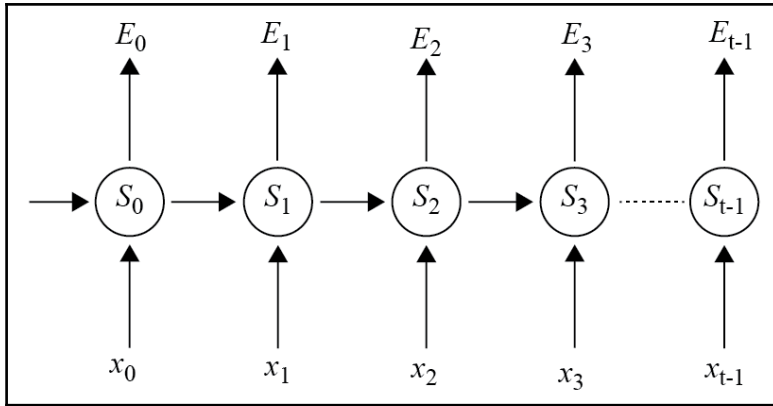

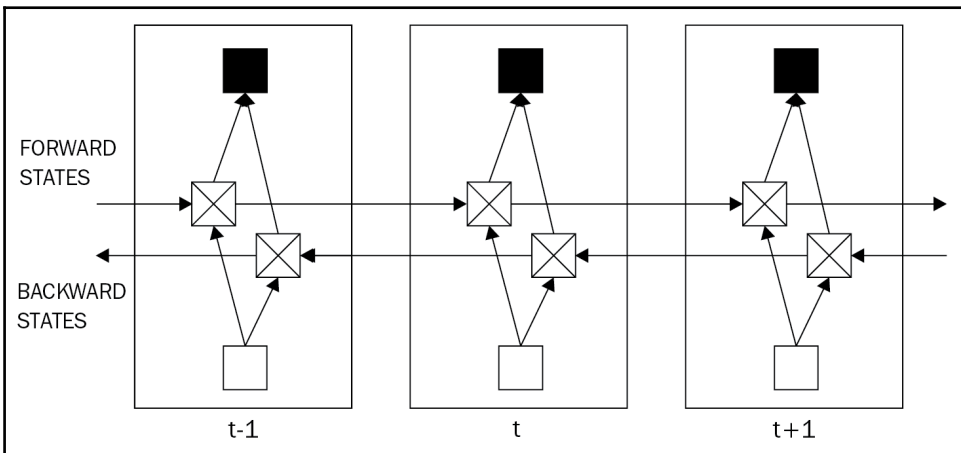
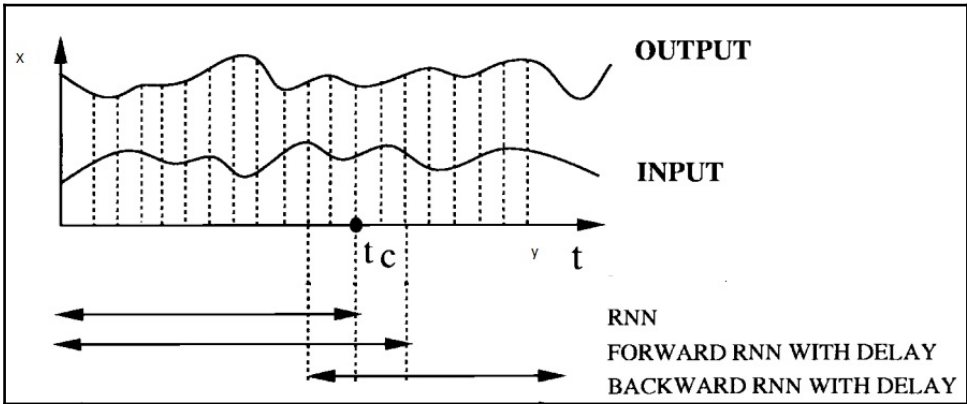
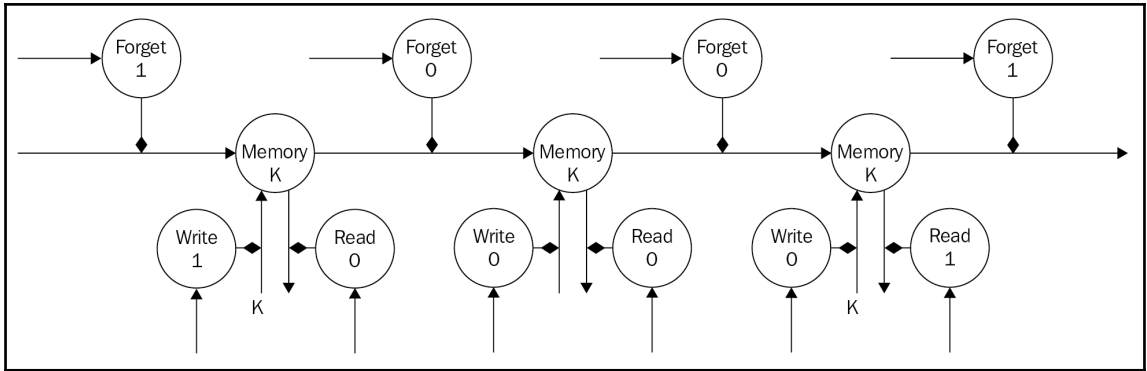

Chapter 5: Restricted Boltzmann Machines

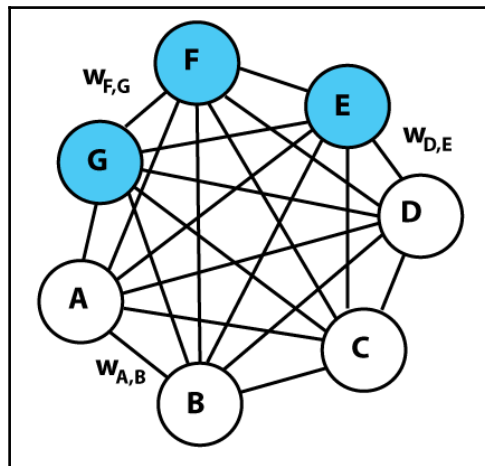
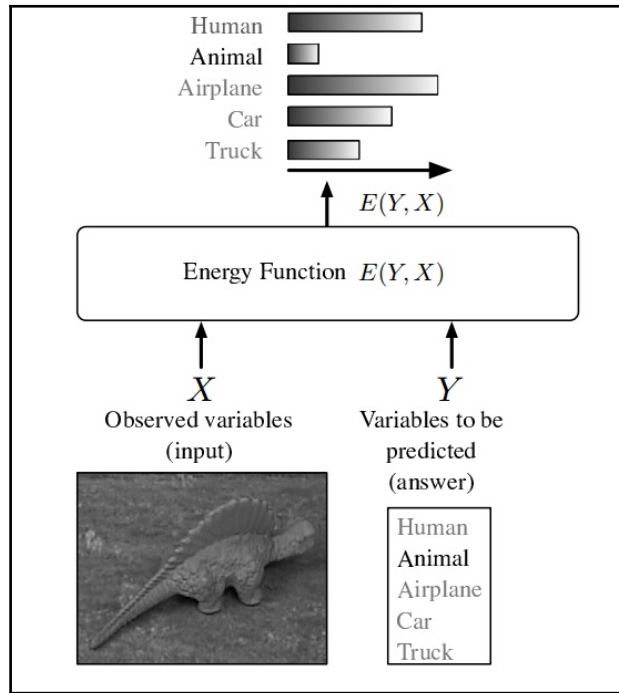

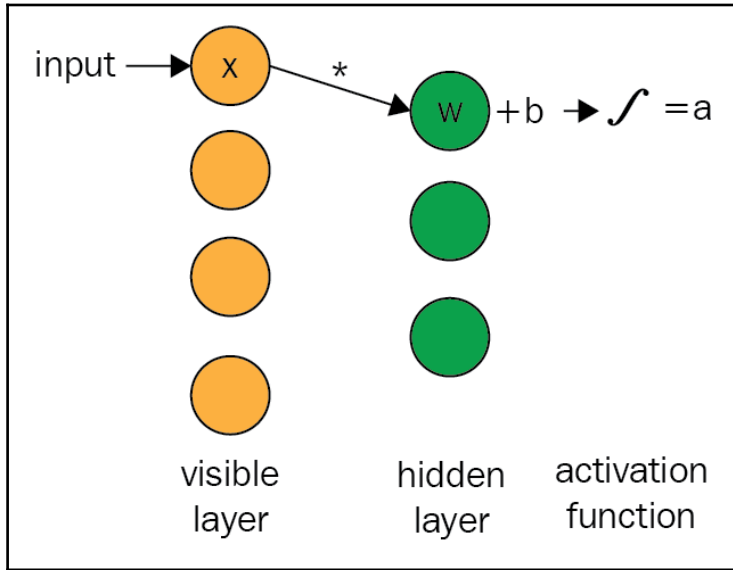
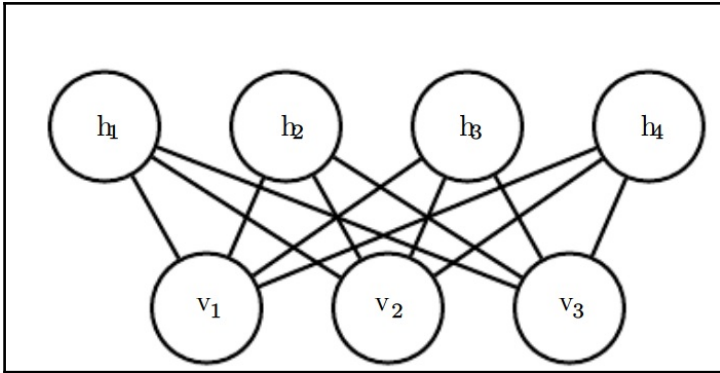

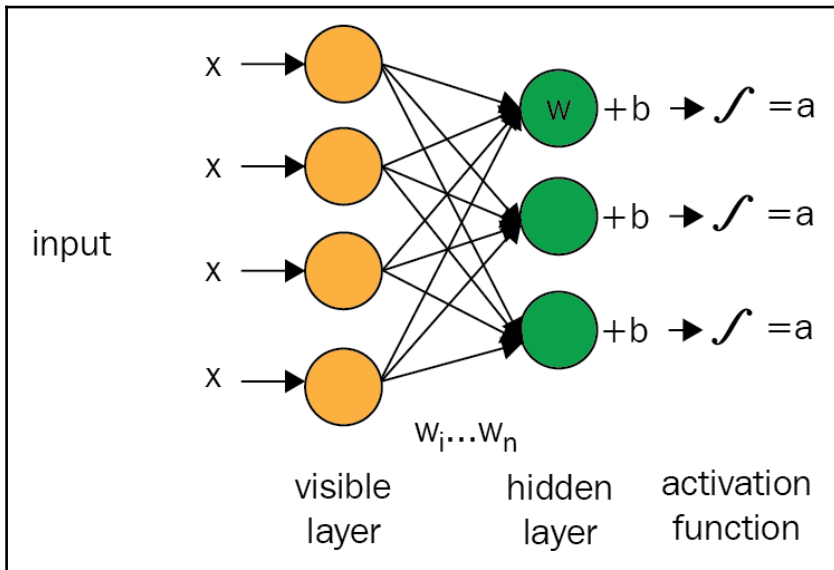
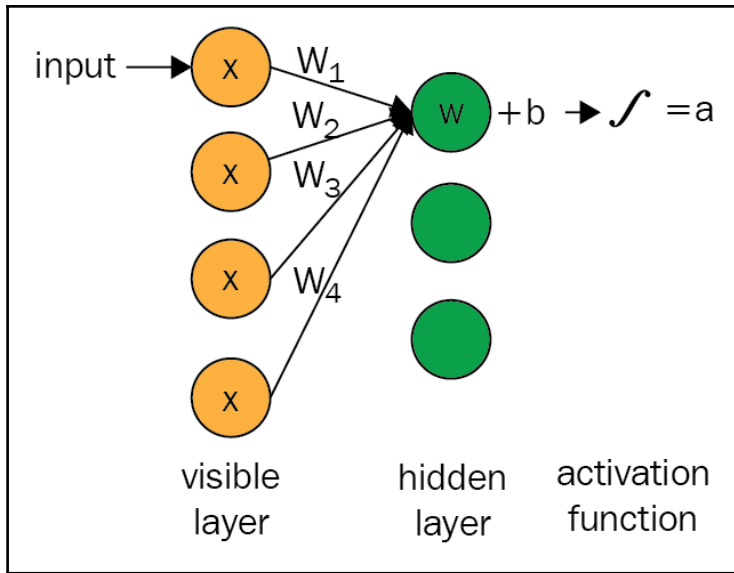

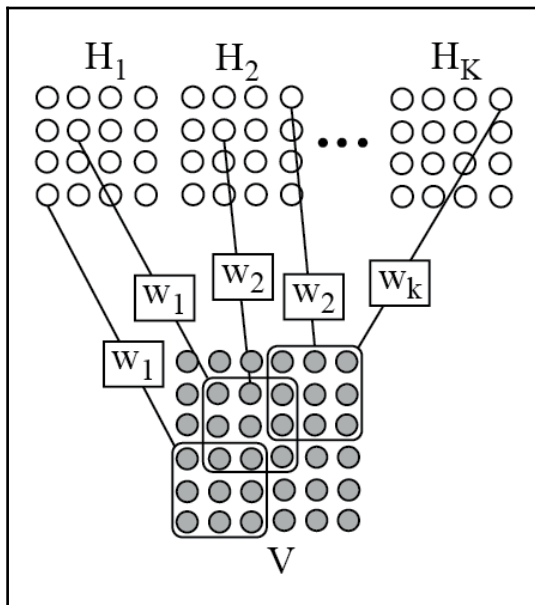
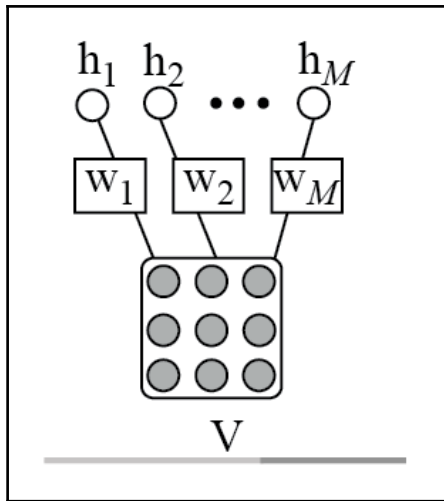

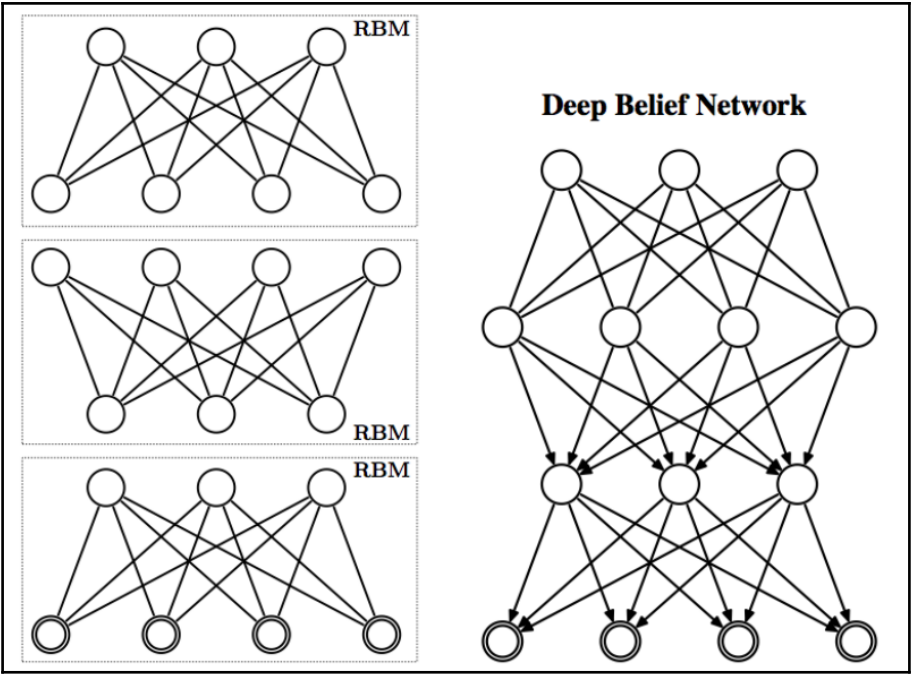

Chapter 6: Deep Belief Networks

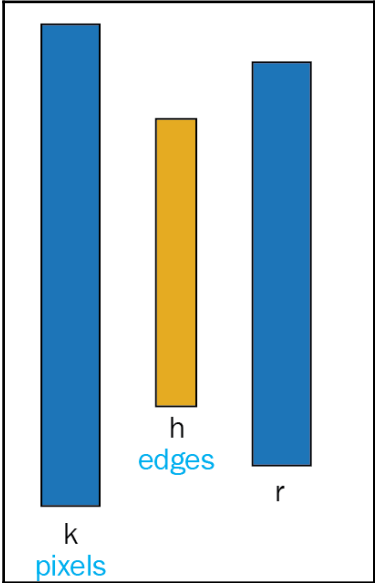
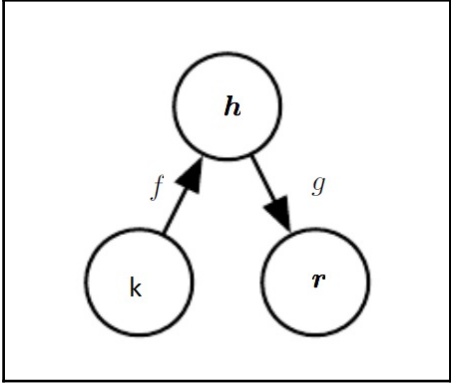

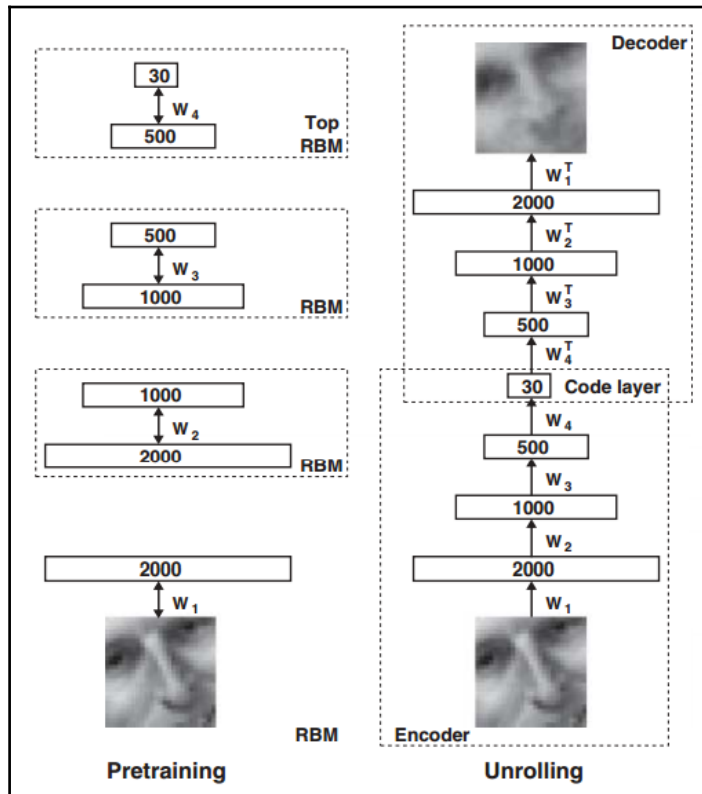
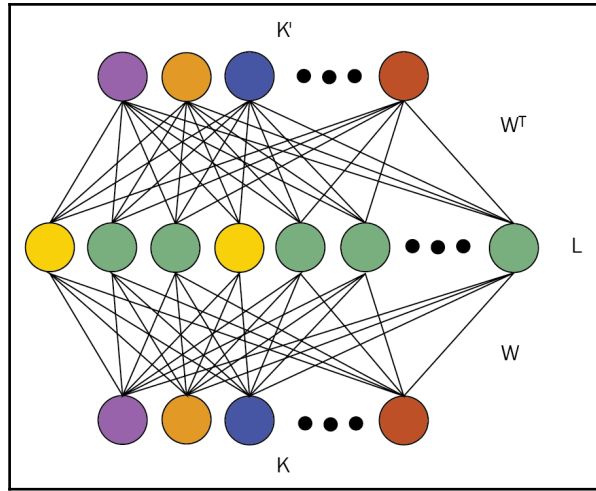

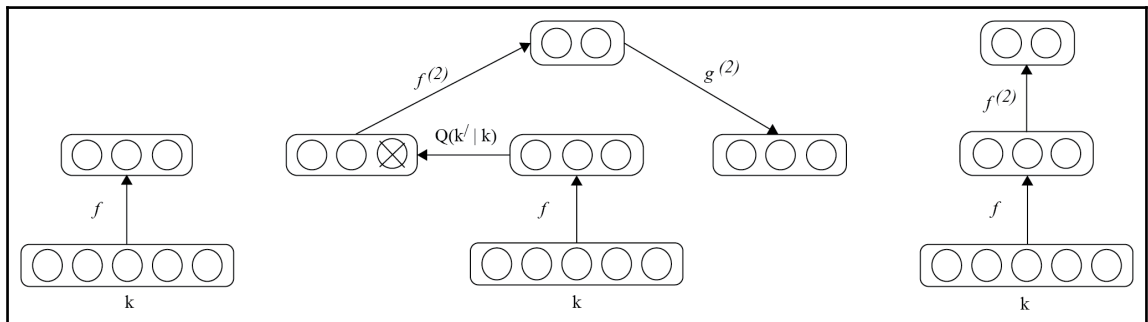
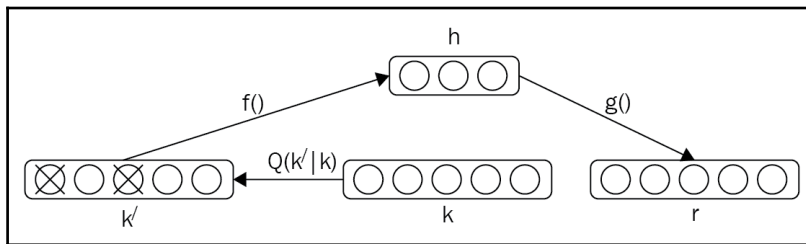
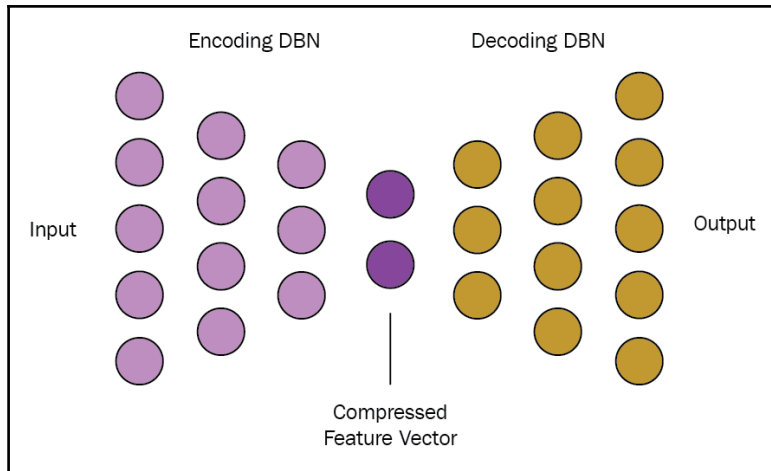

Chapter 7: Miscellaneous Deep Learning Operations on Hadoop

