

Chapter 01: Introduction to Smart Robots

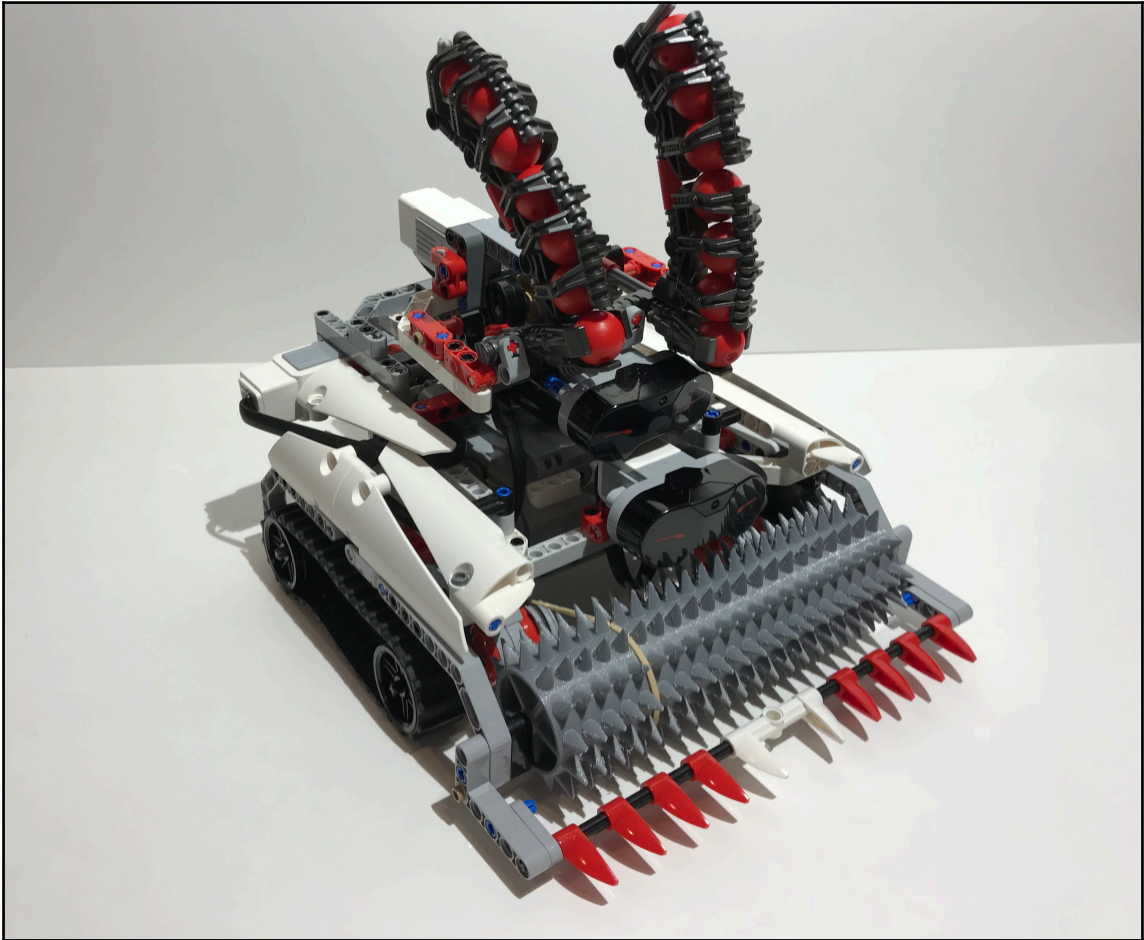



Chapter 02: Security Tank – Object-Tracking Robot



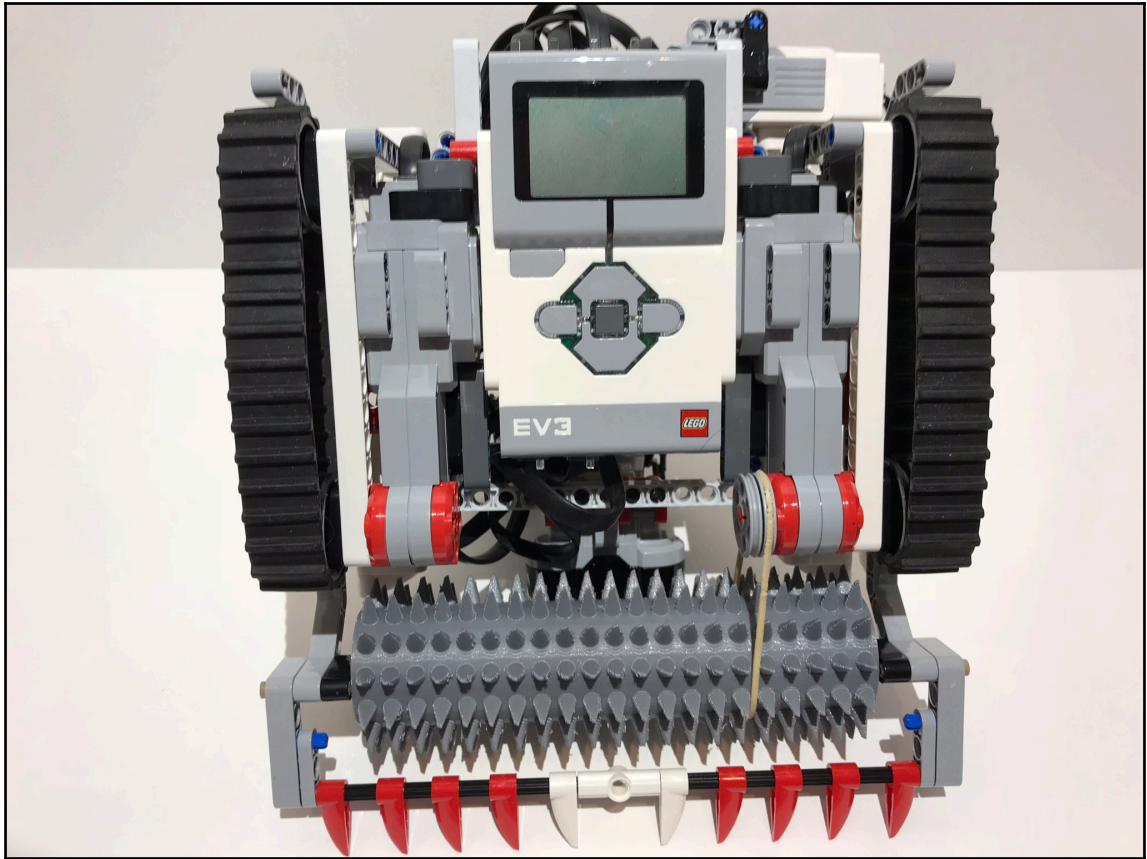

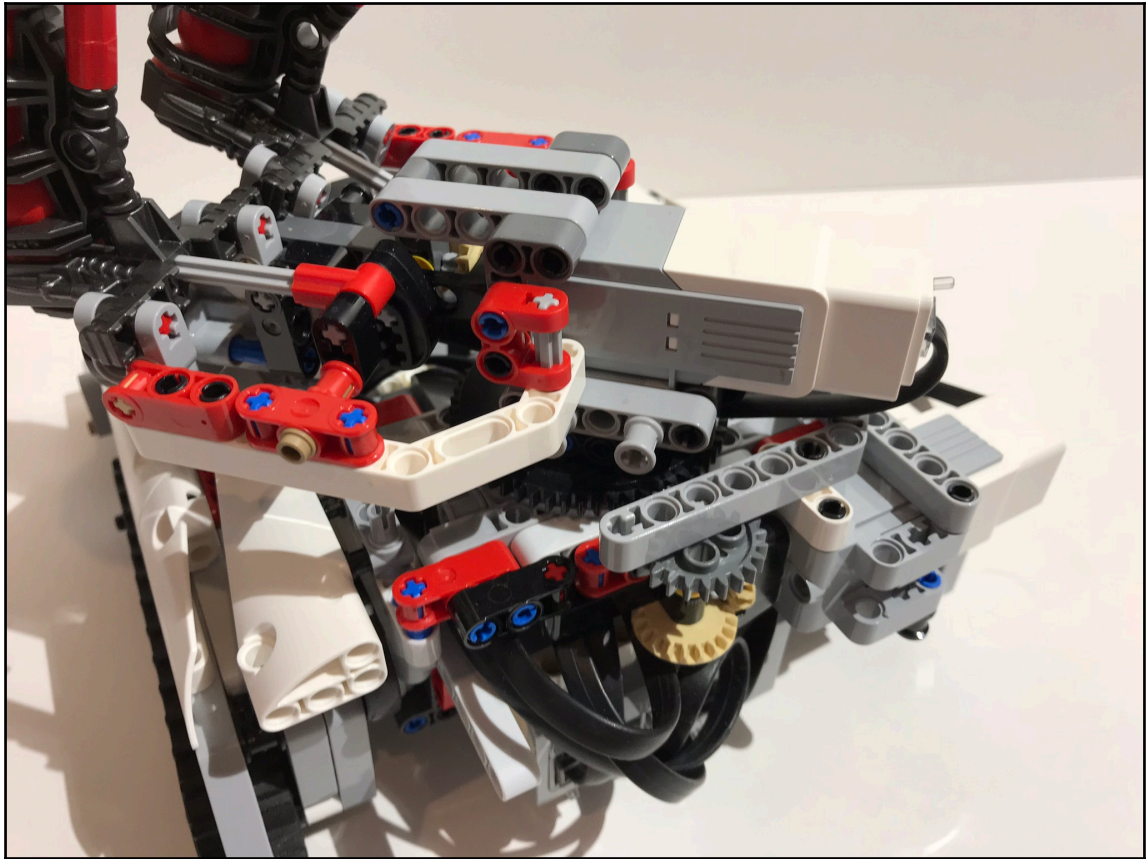



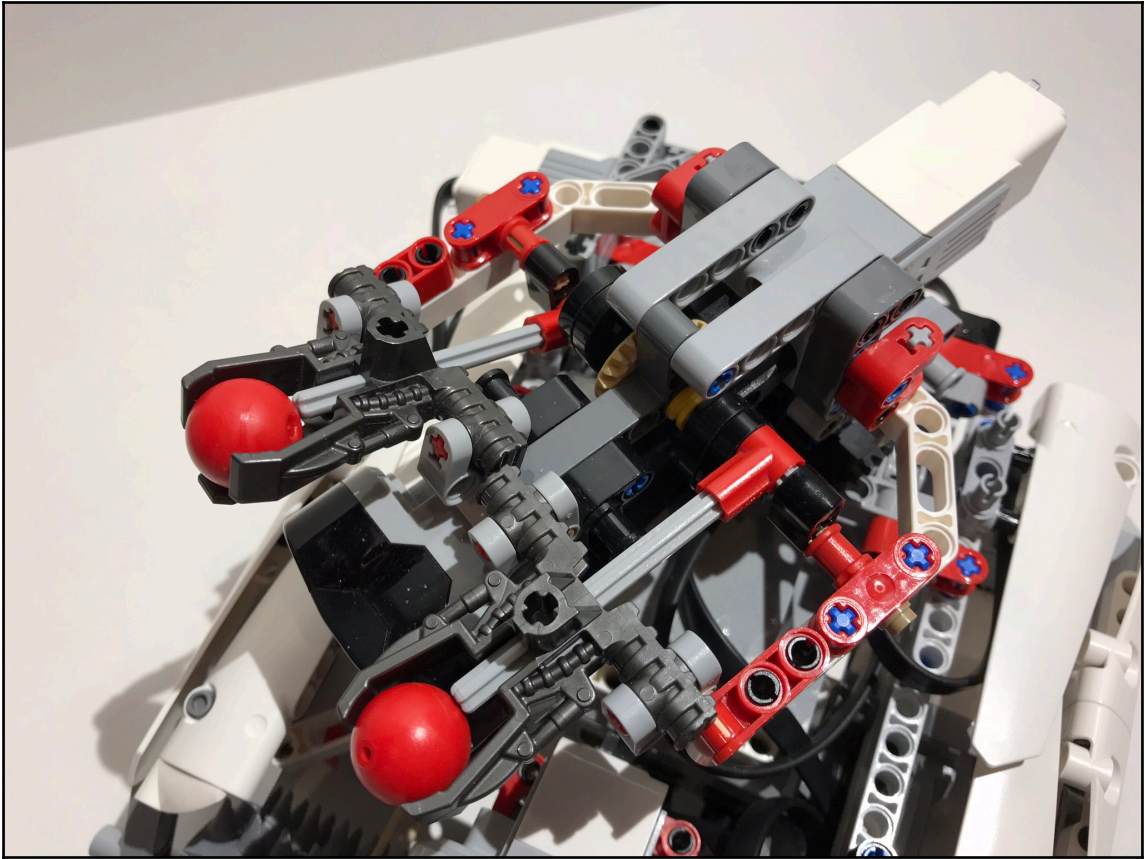

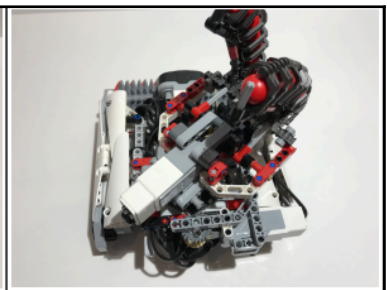
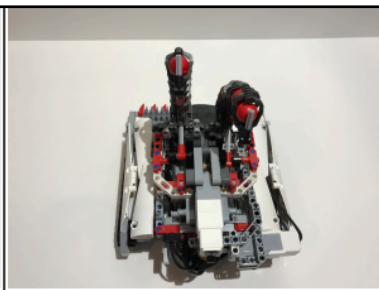
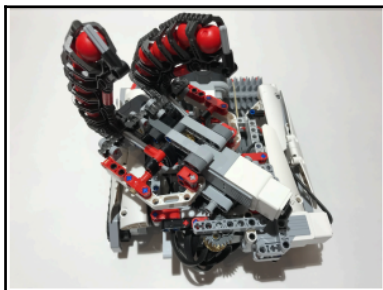
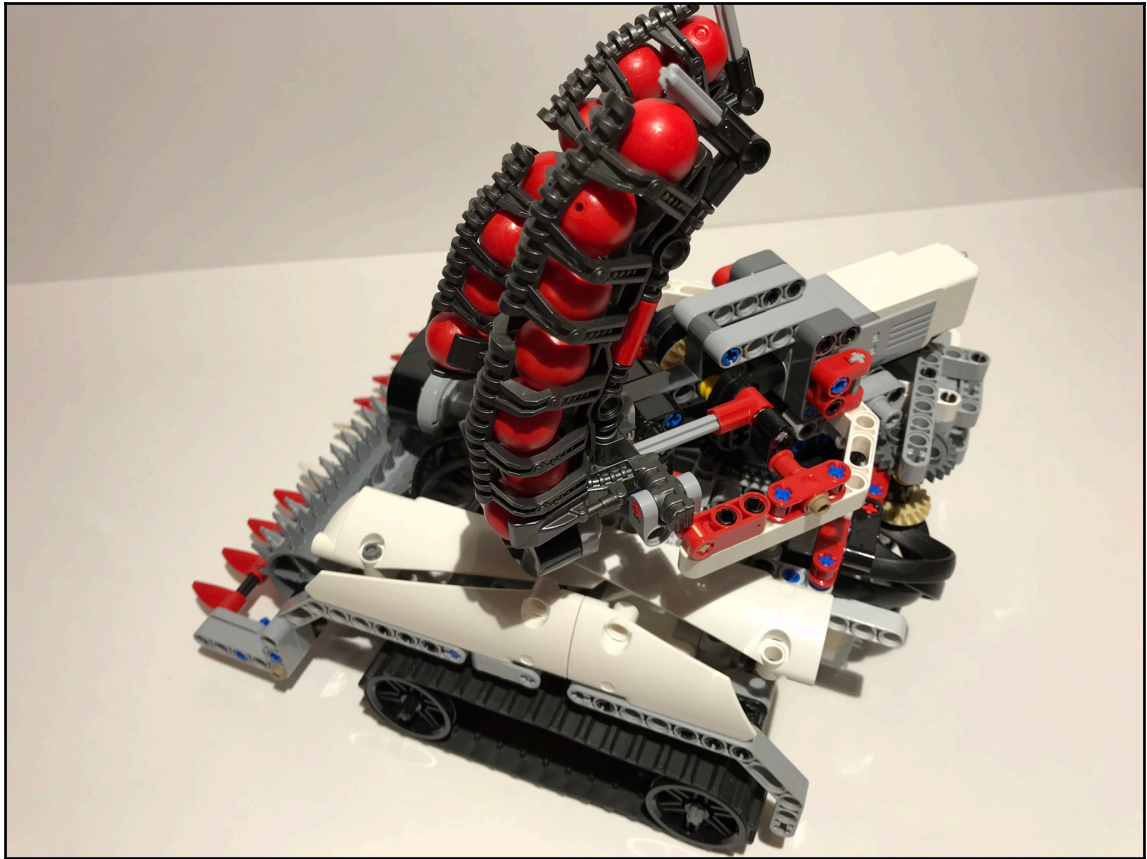

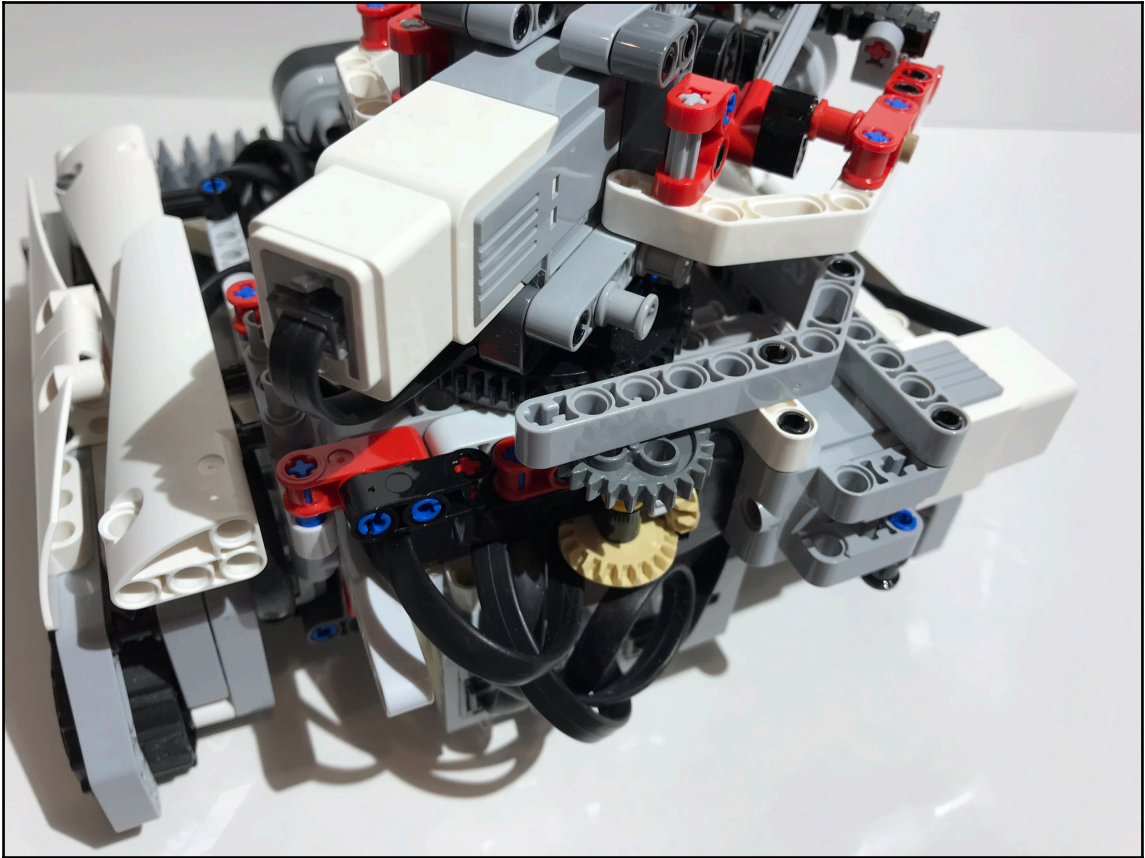

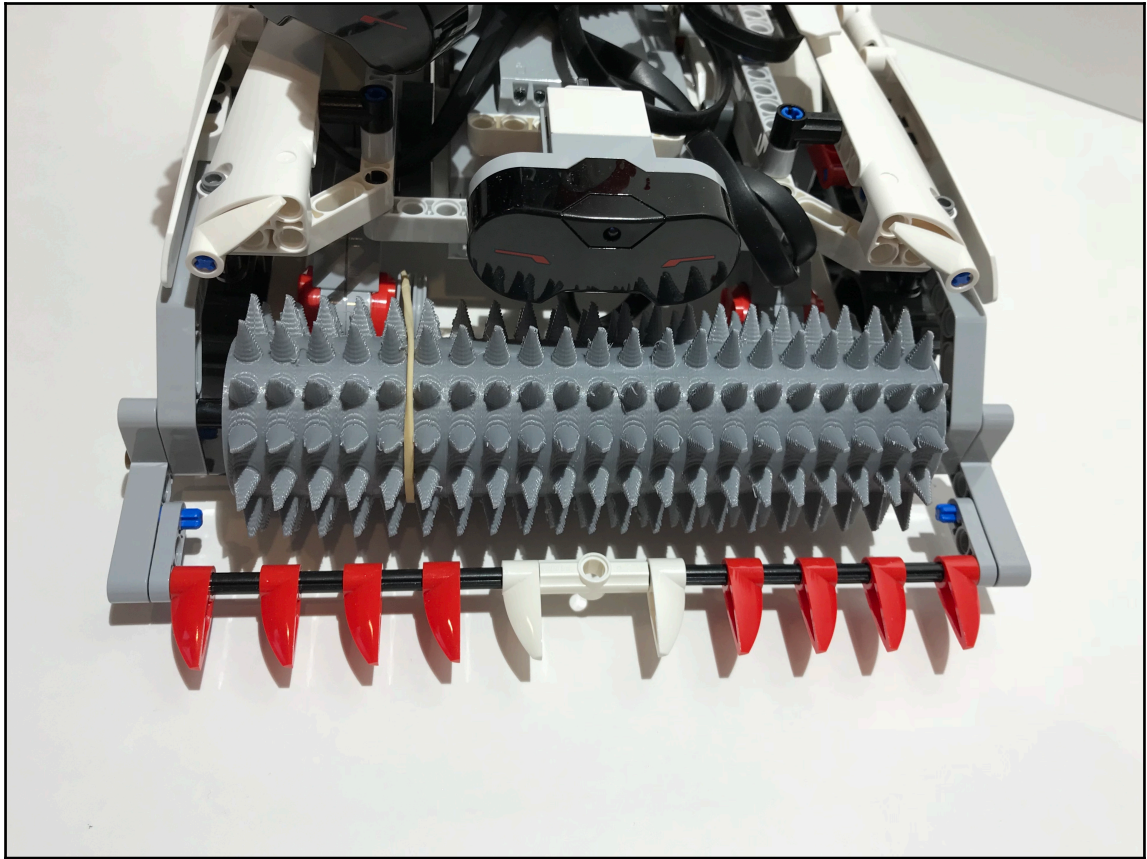

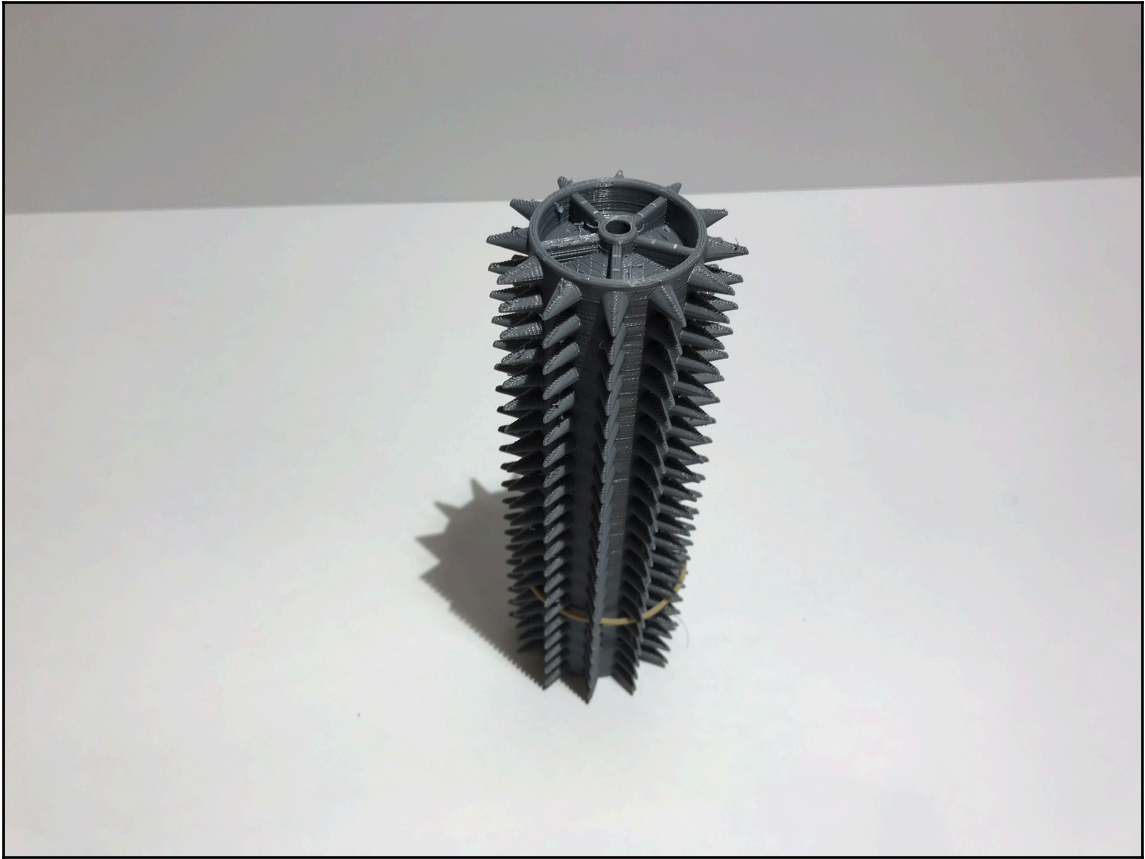

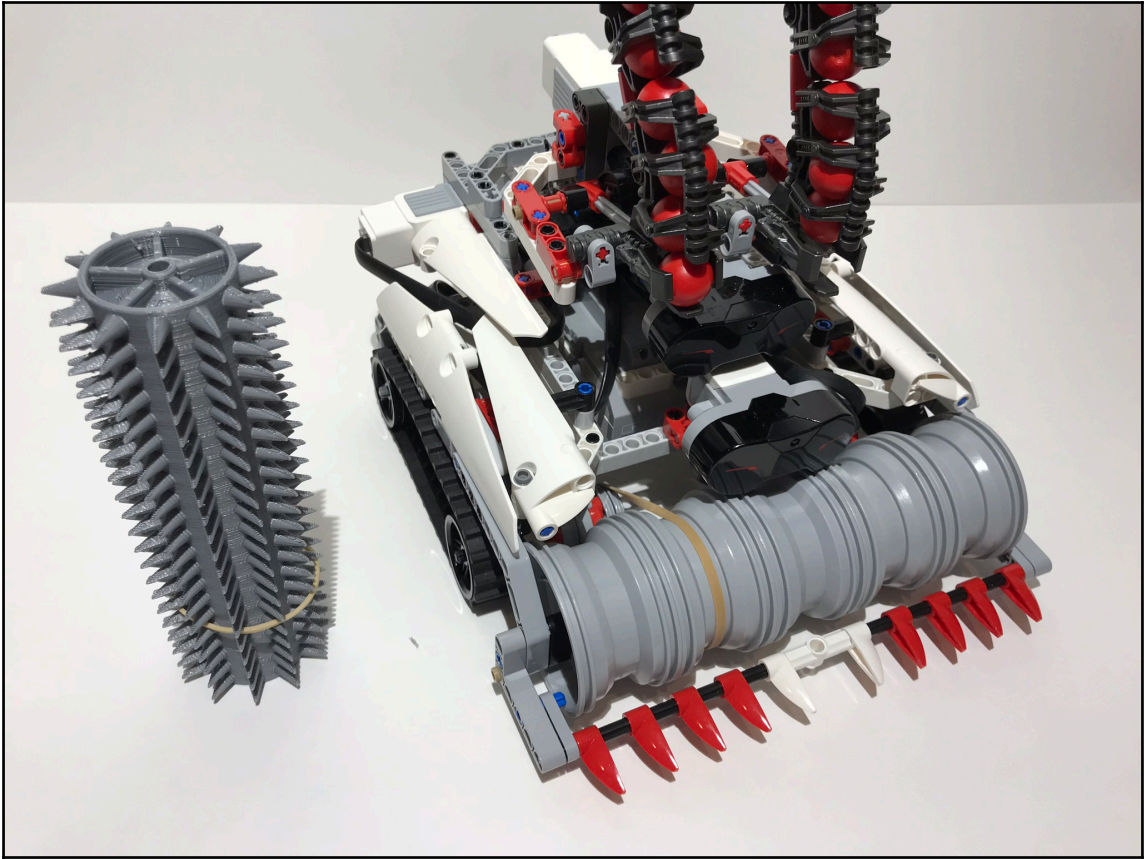

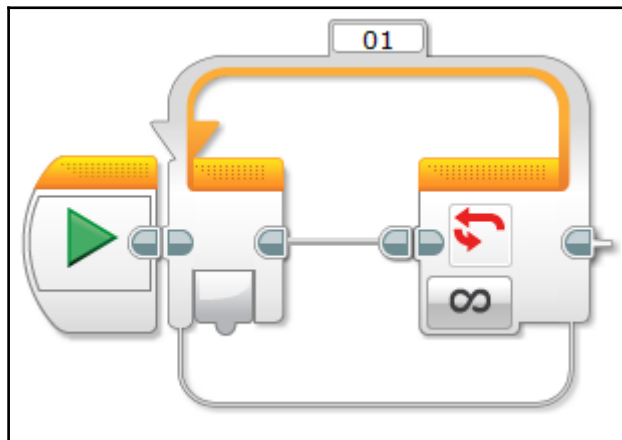
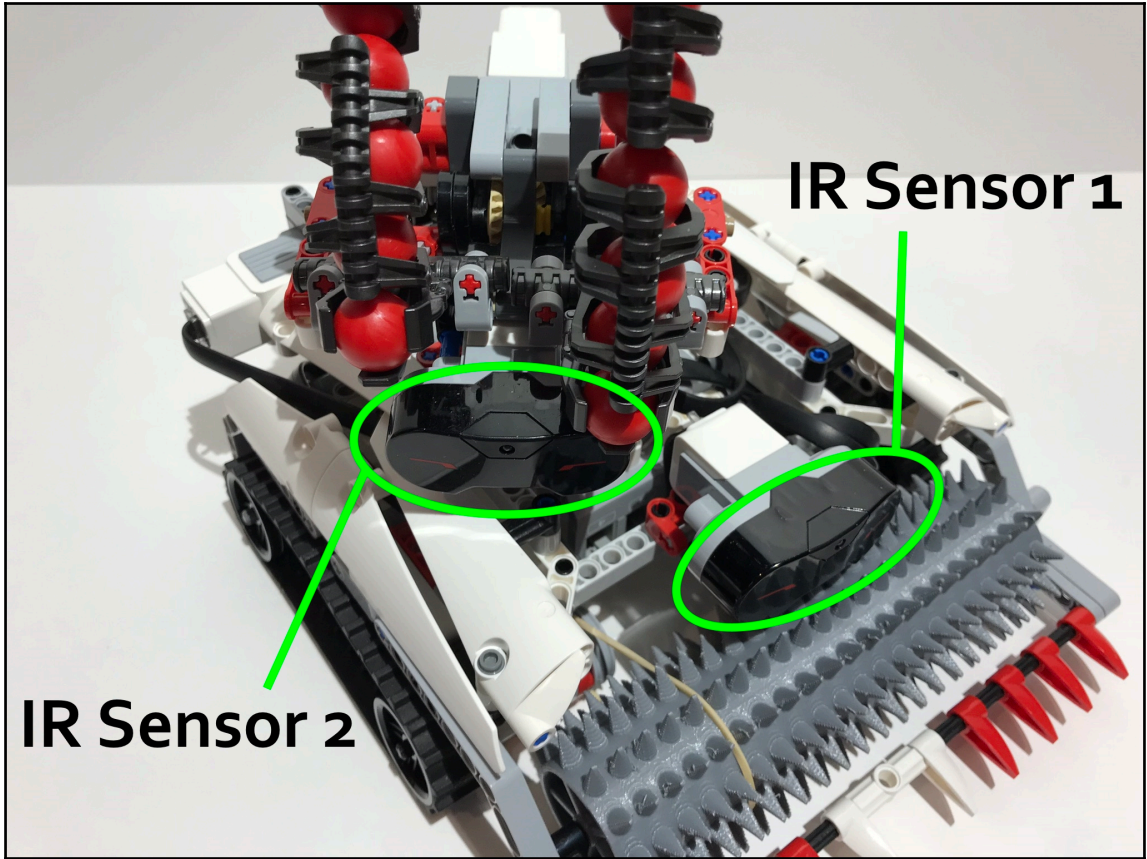

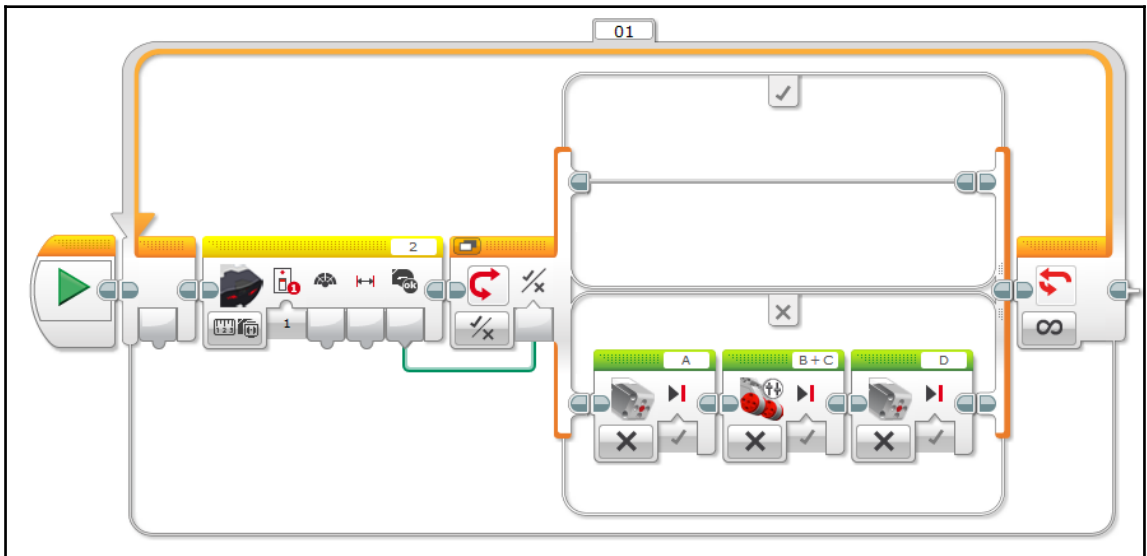
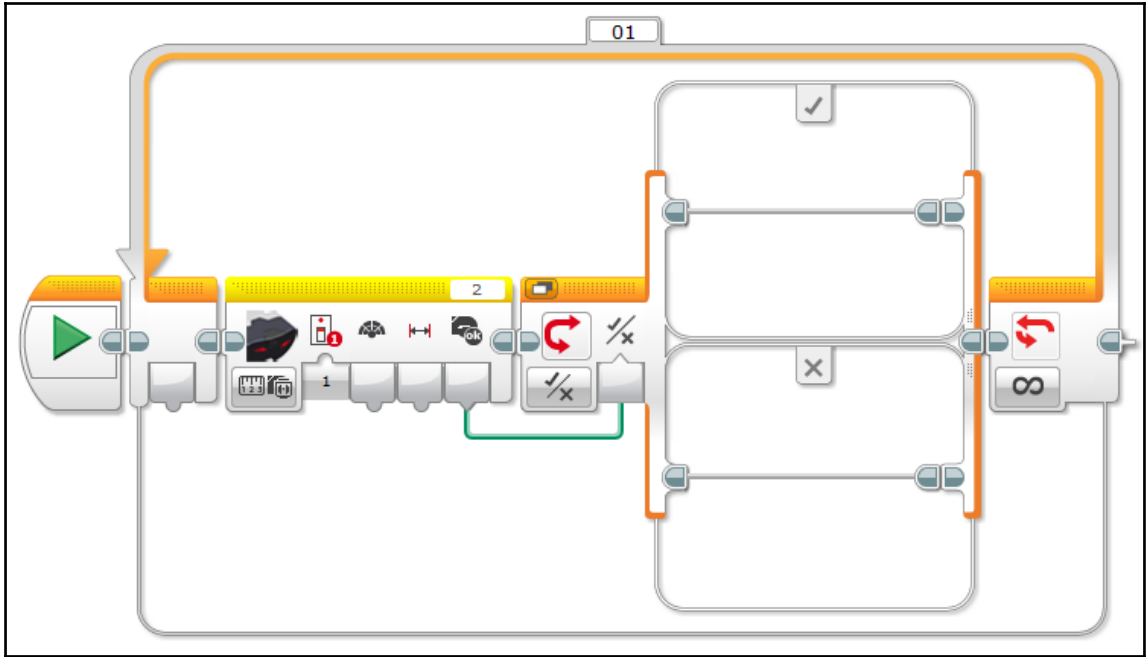

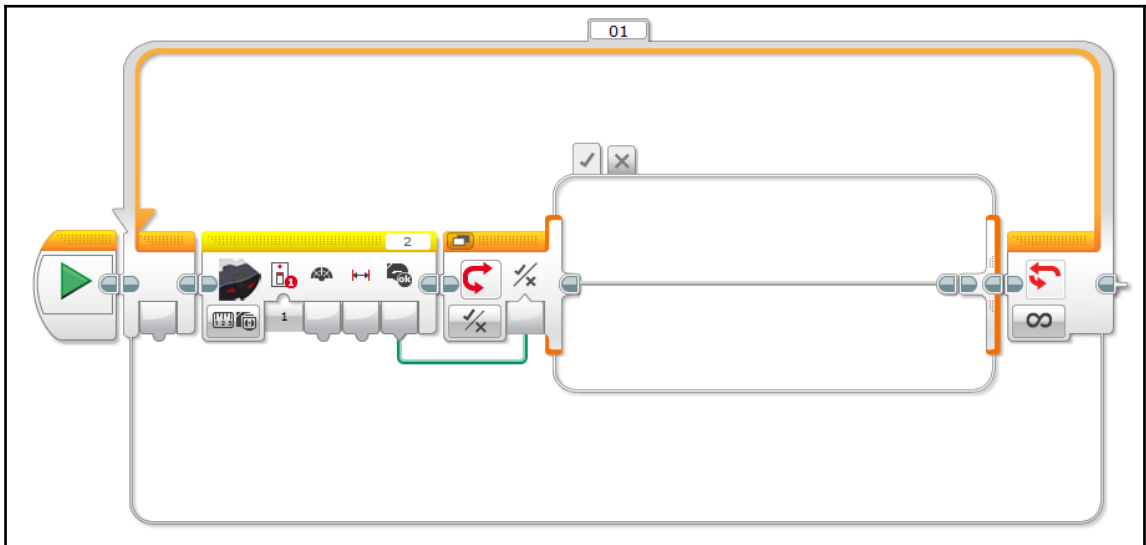
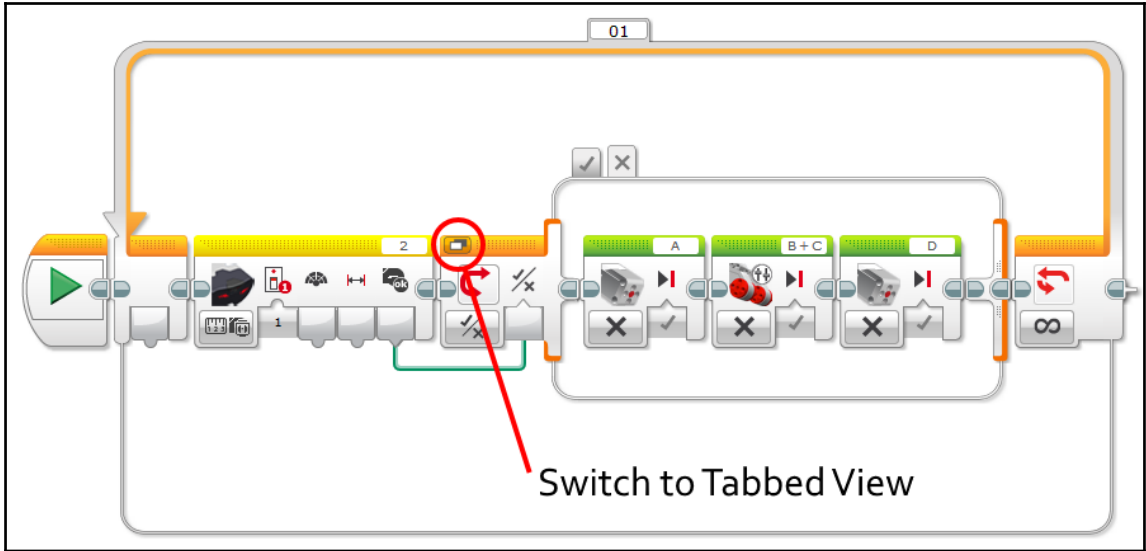

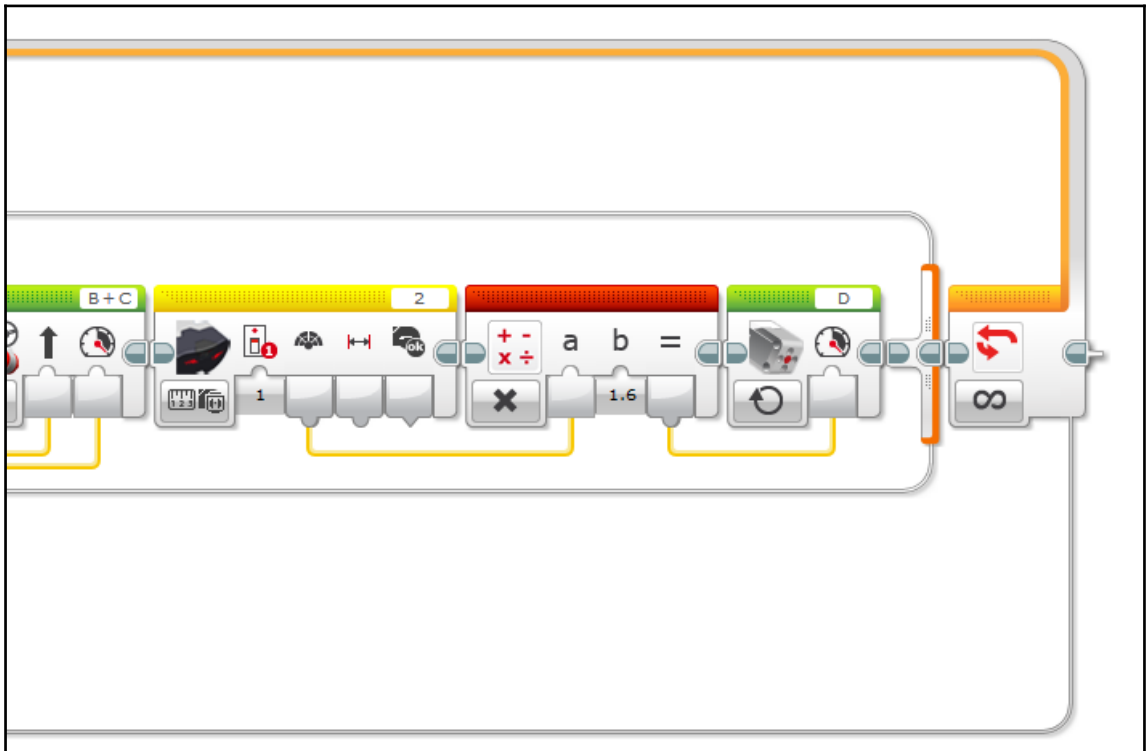
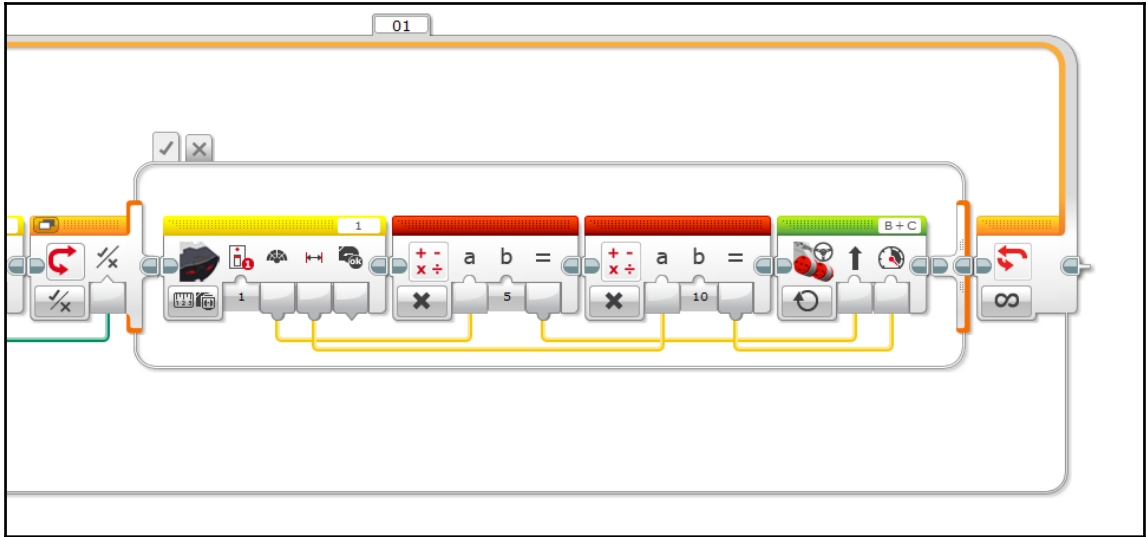

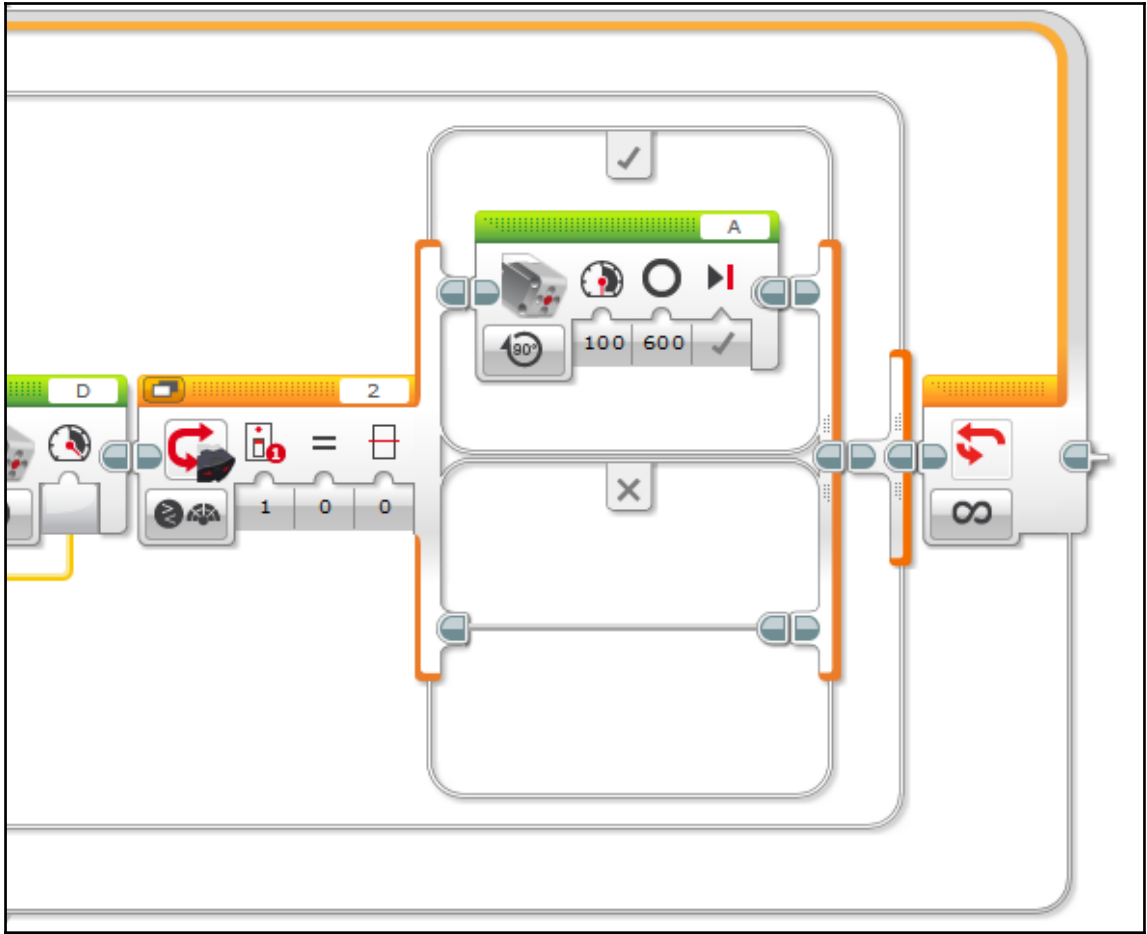

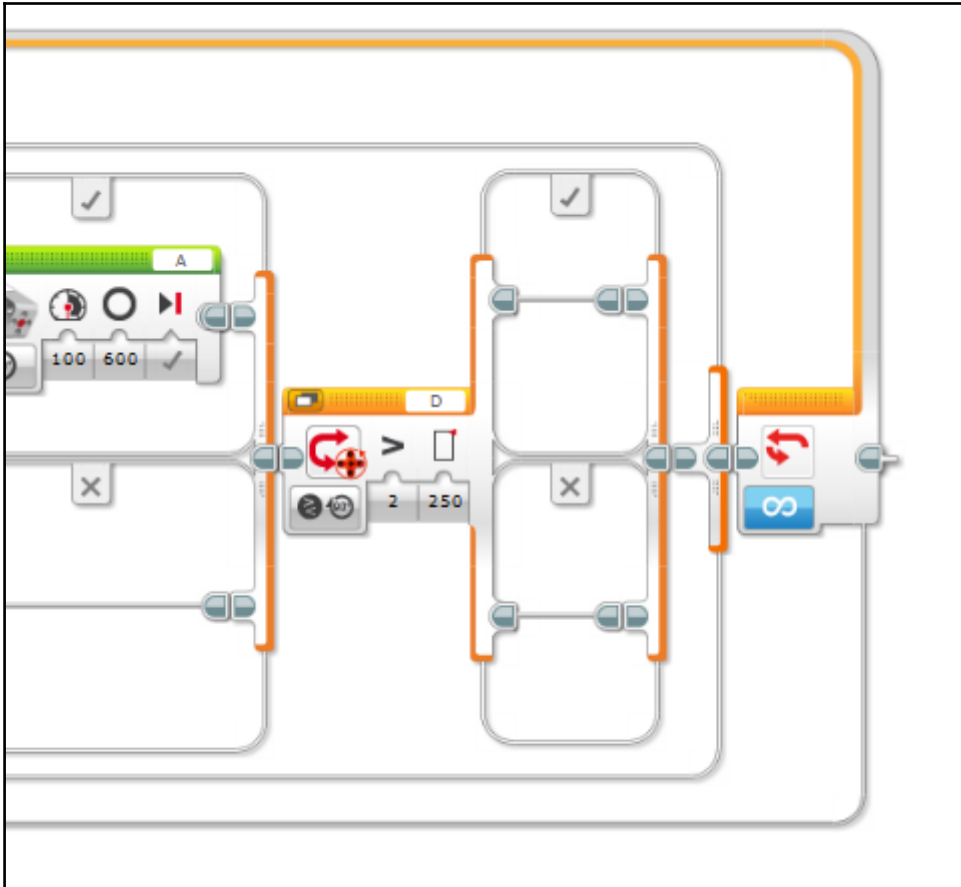

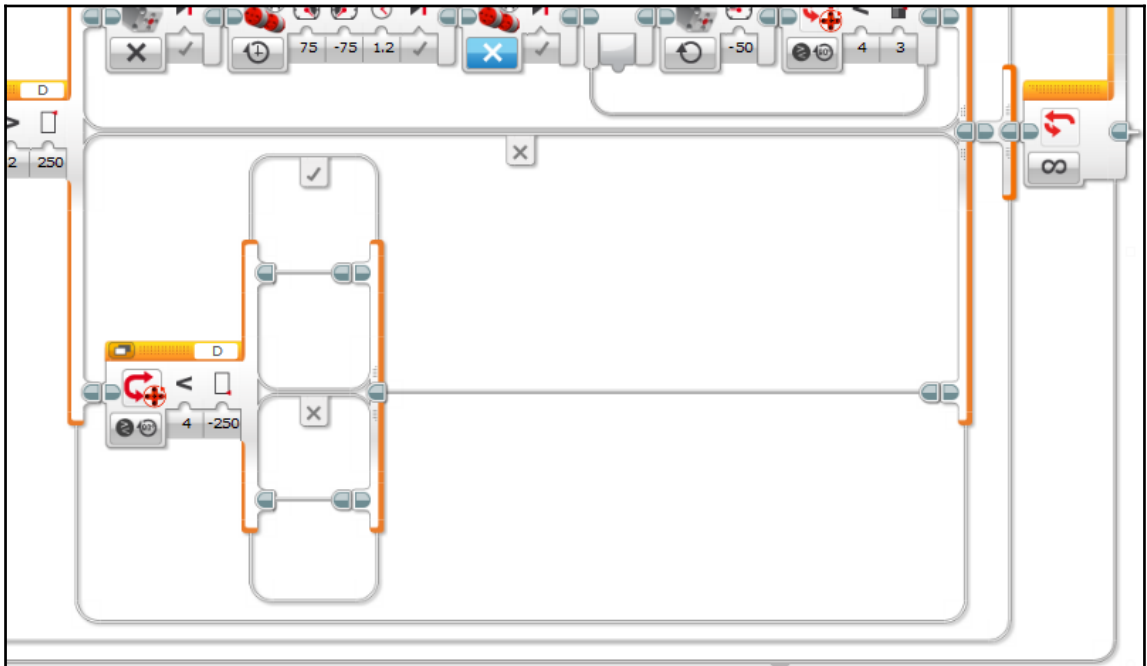
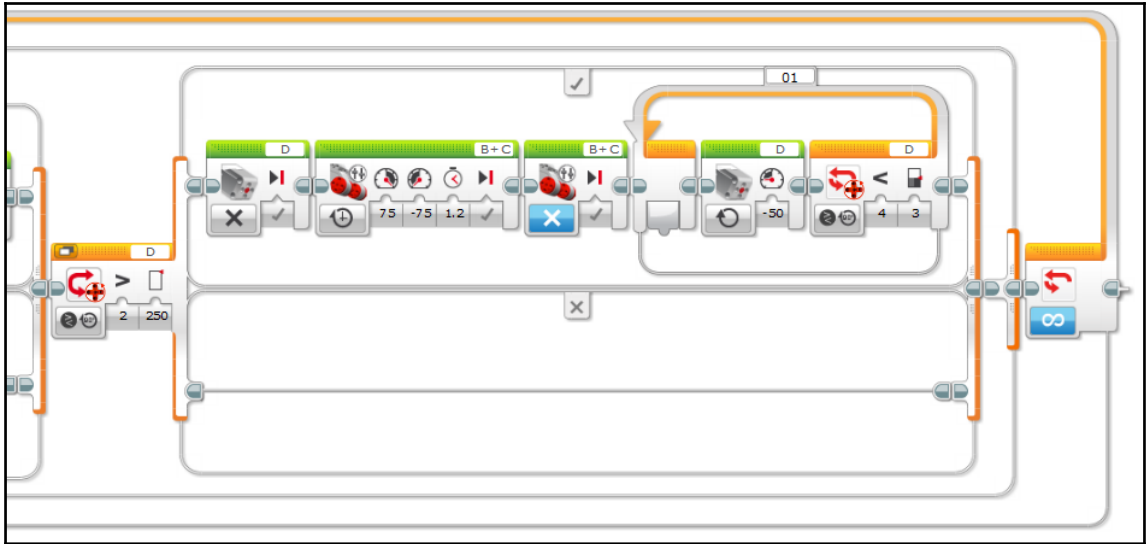

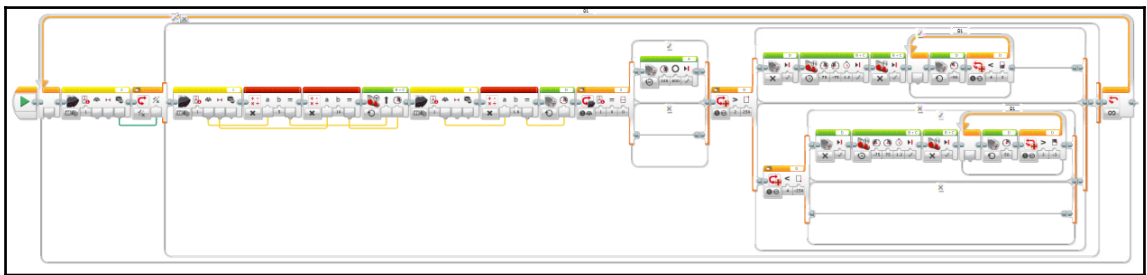
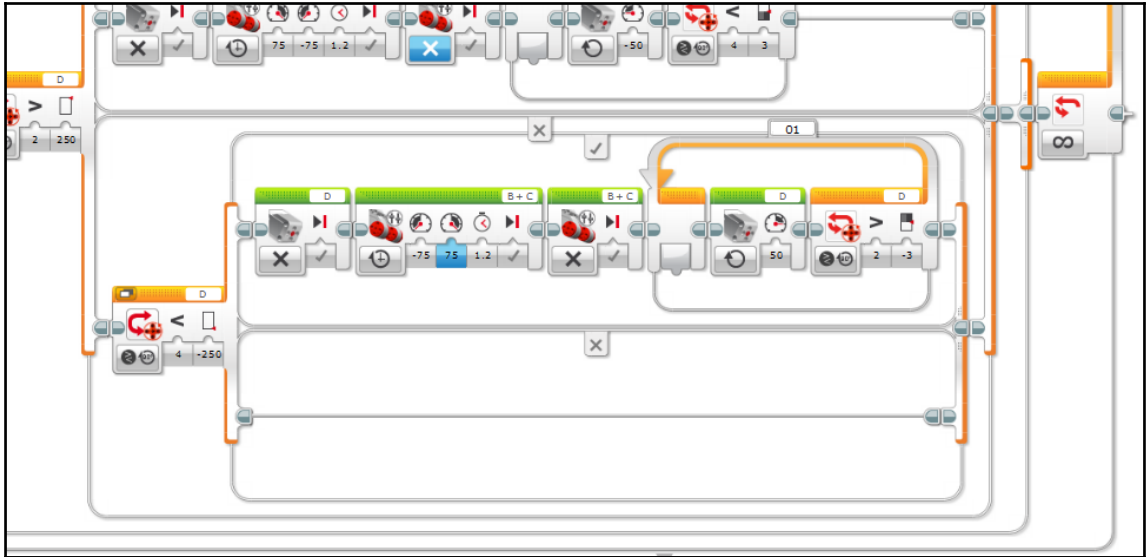

Chapter 03: Omnilander – Ultimate All-Terrain Vehicle

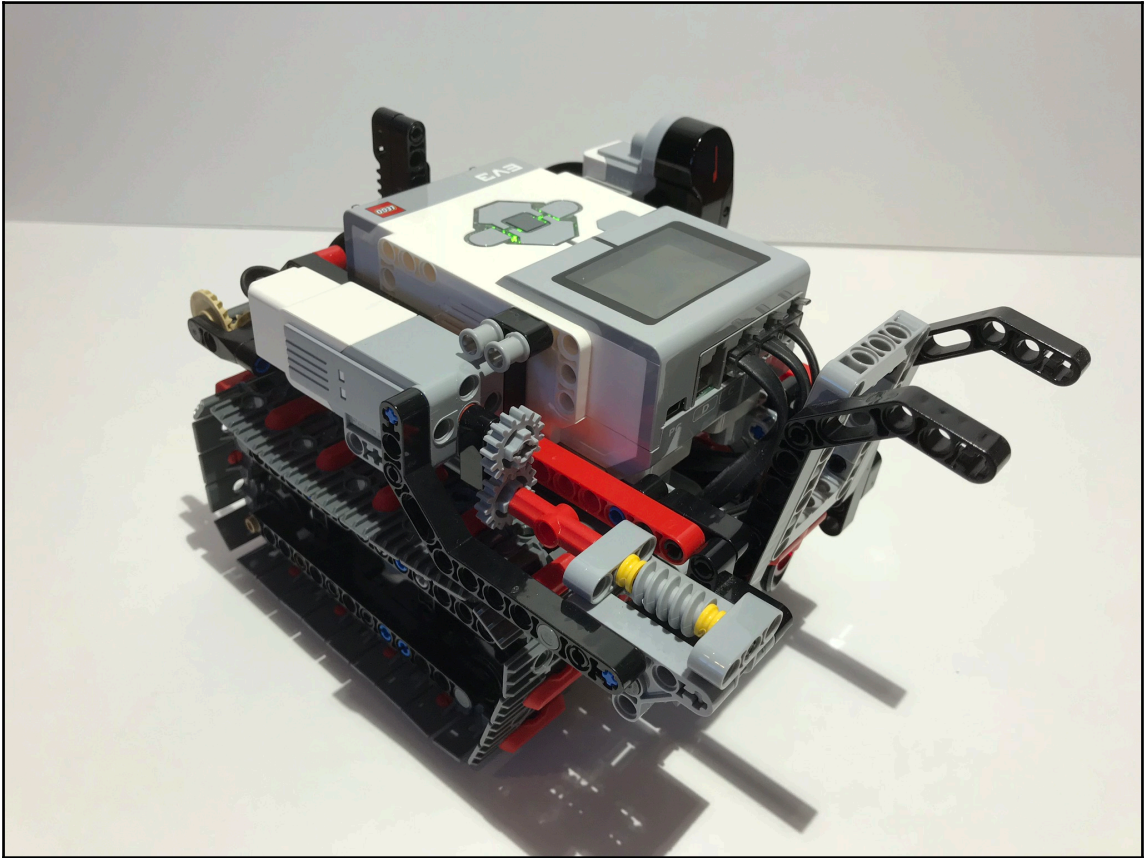

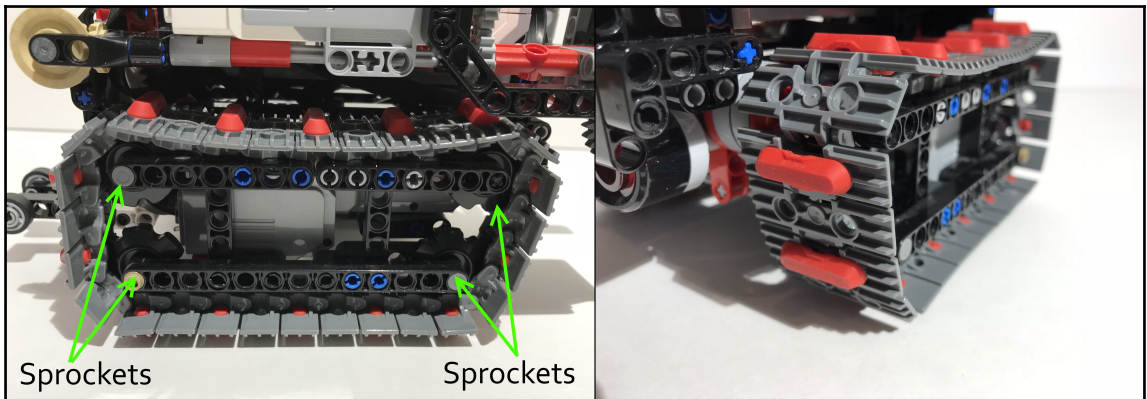
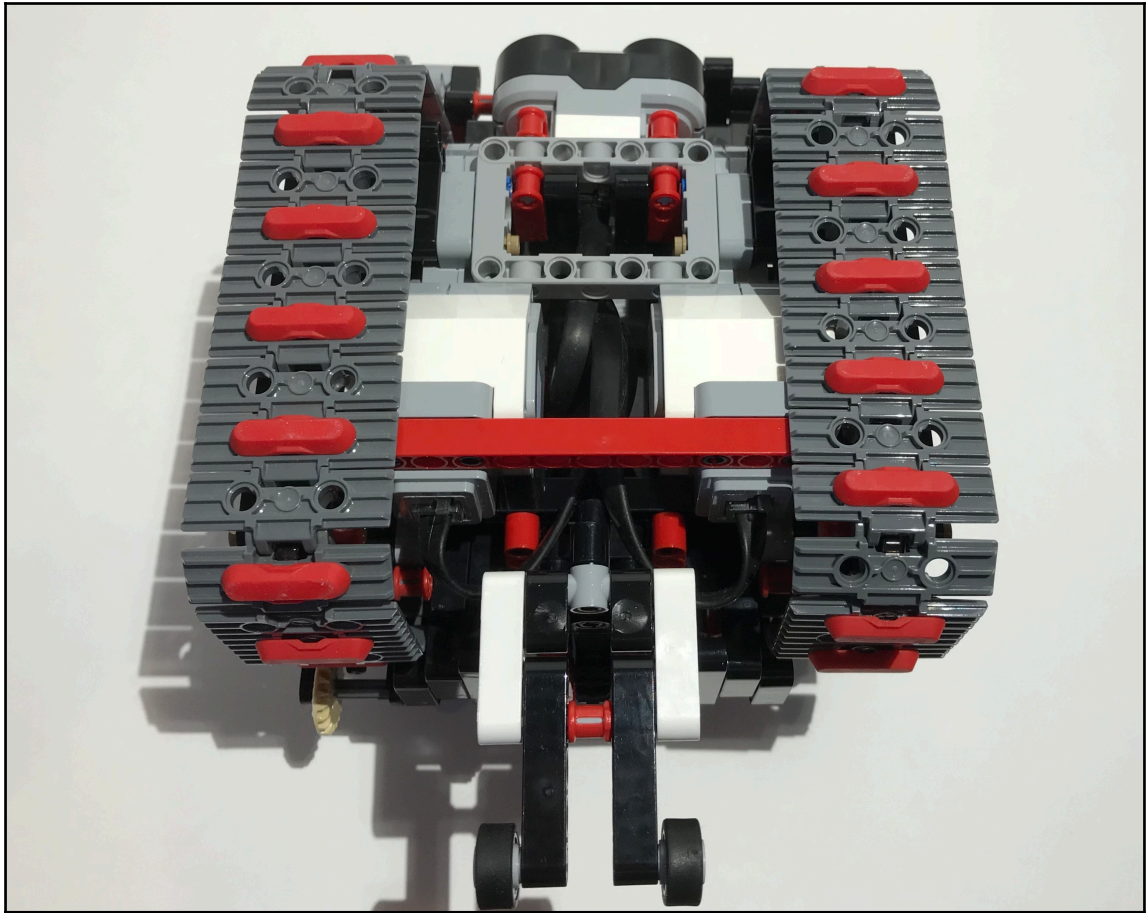

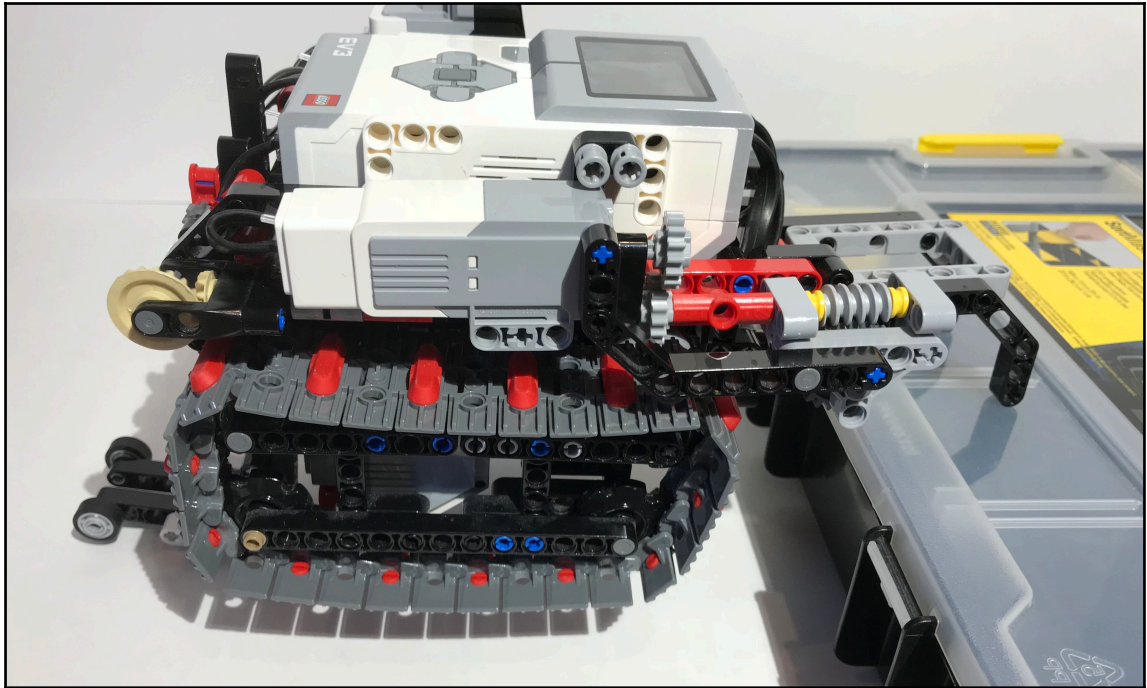

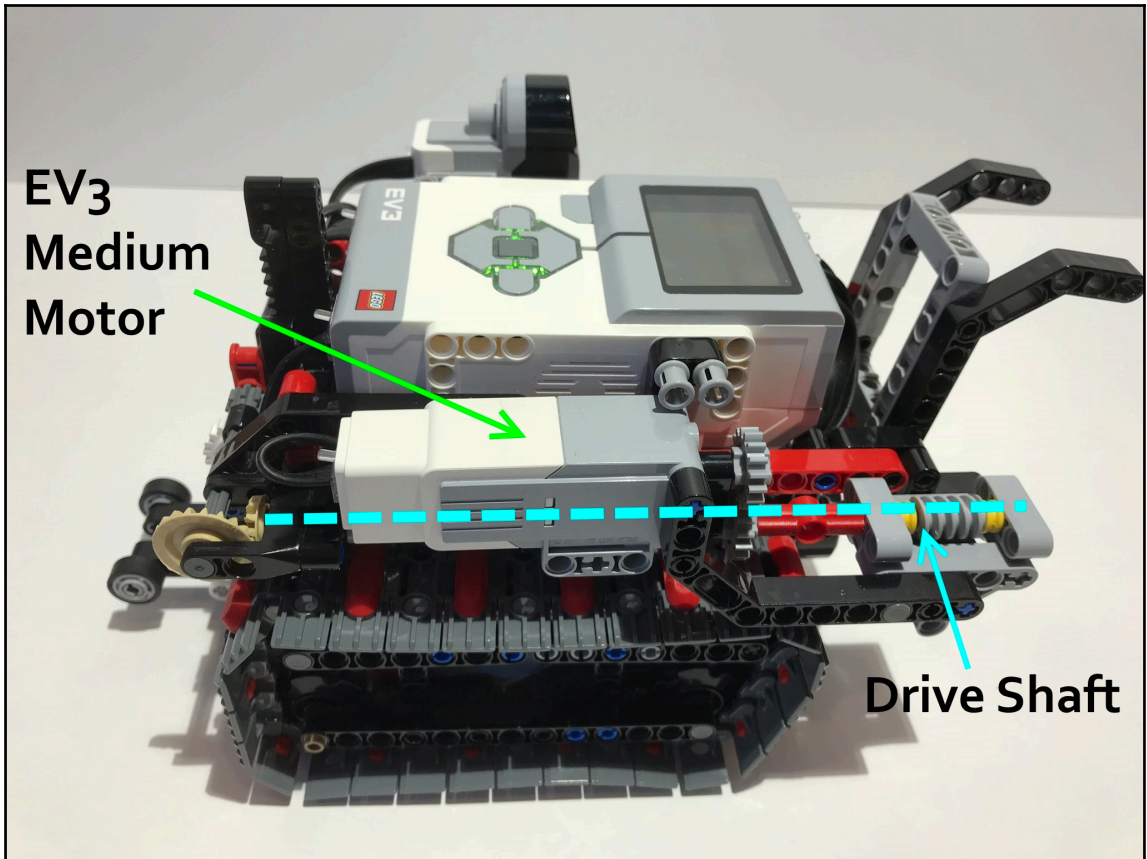

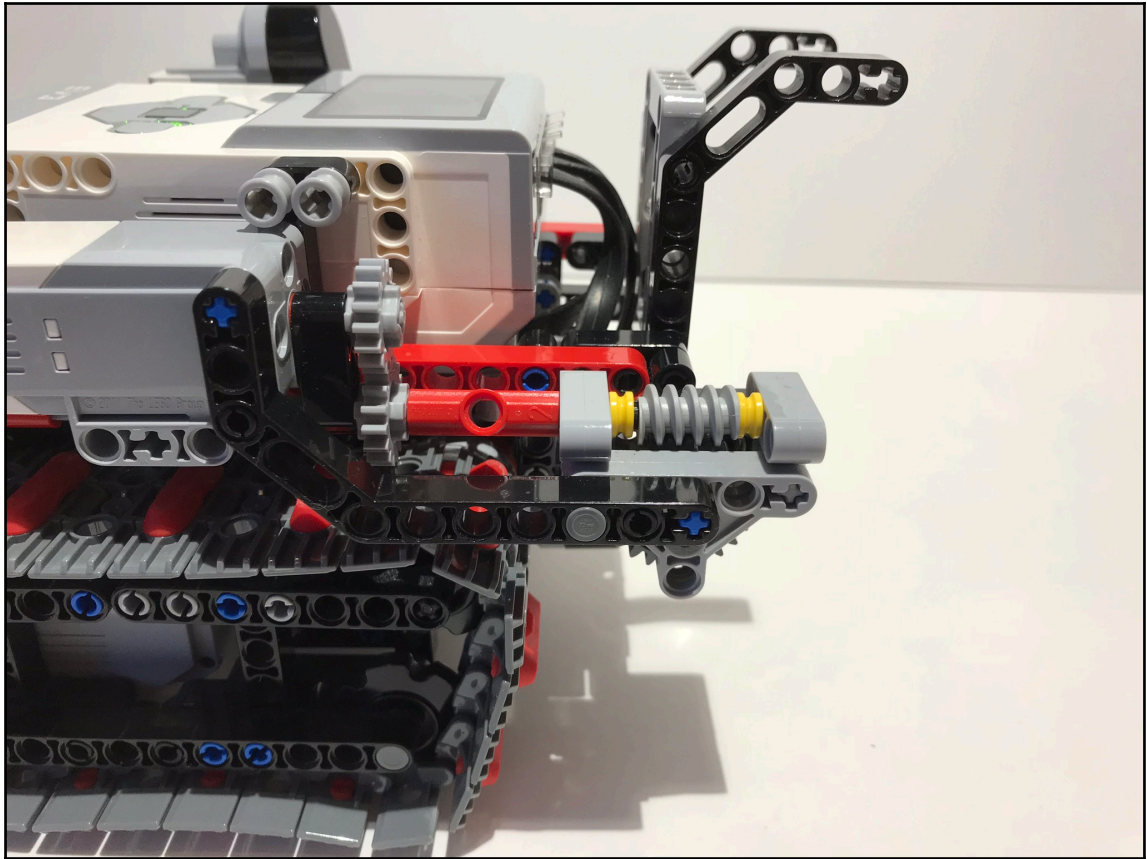

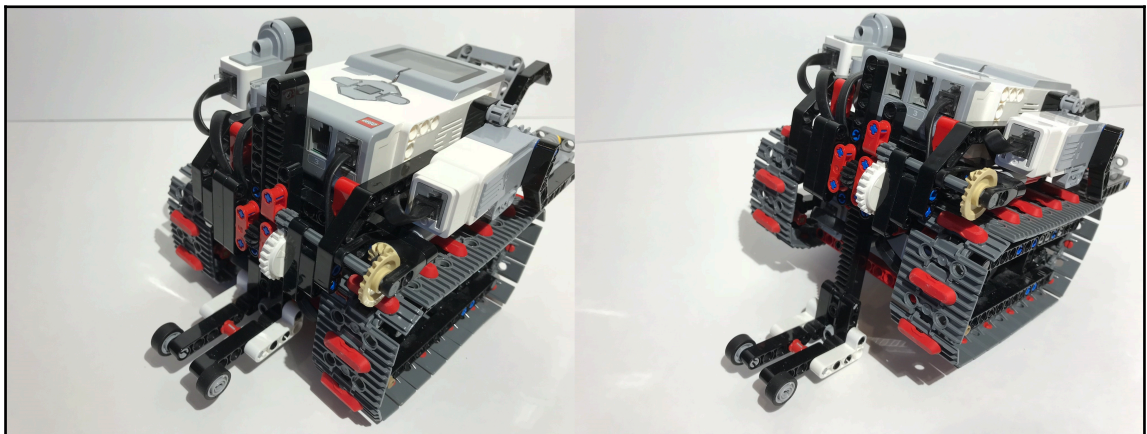
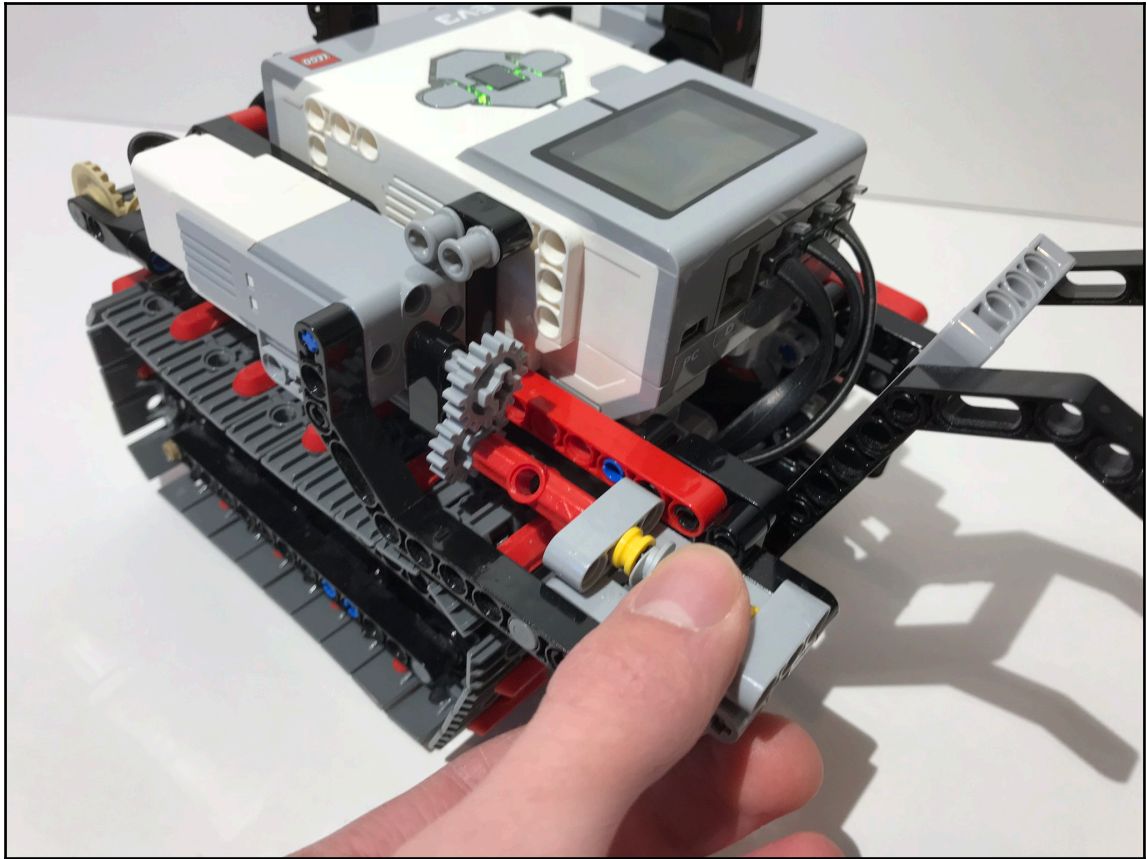

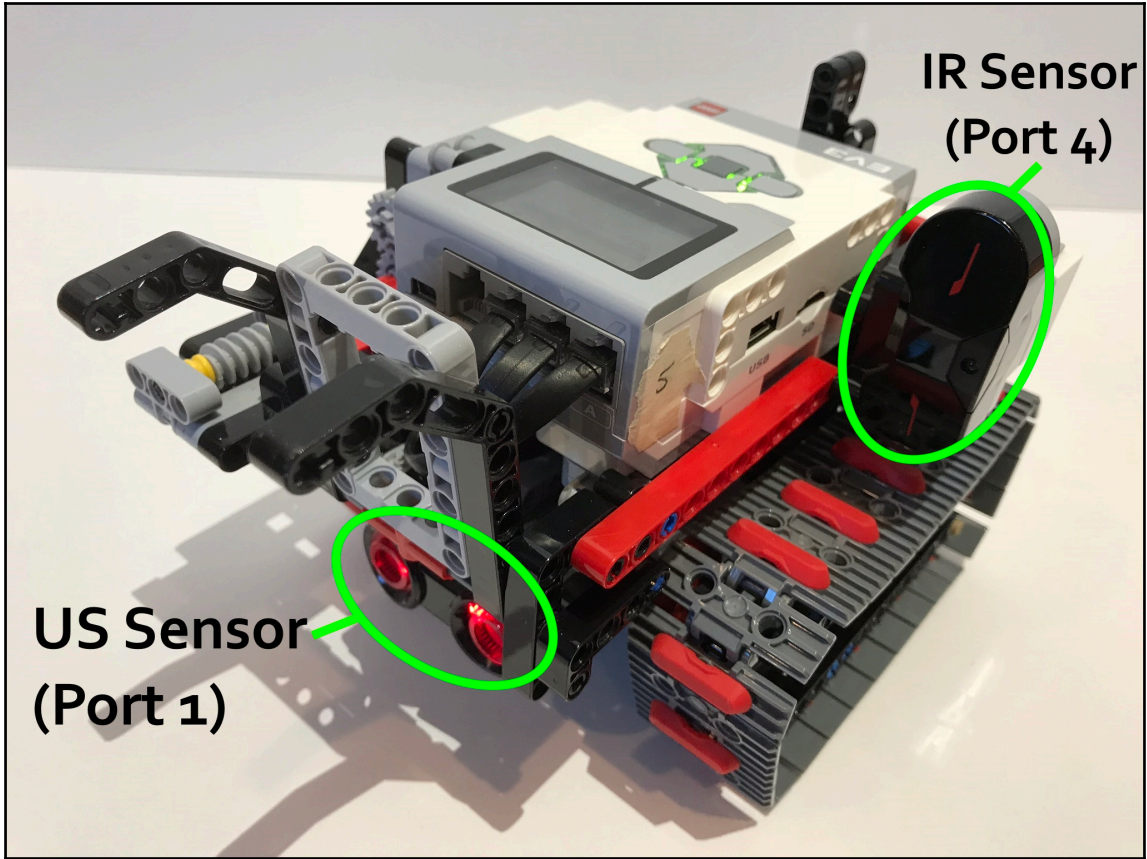

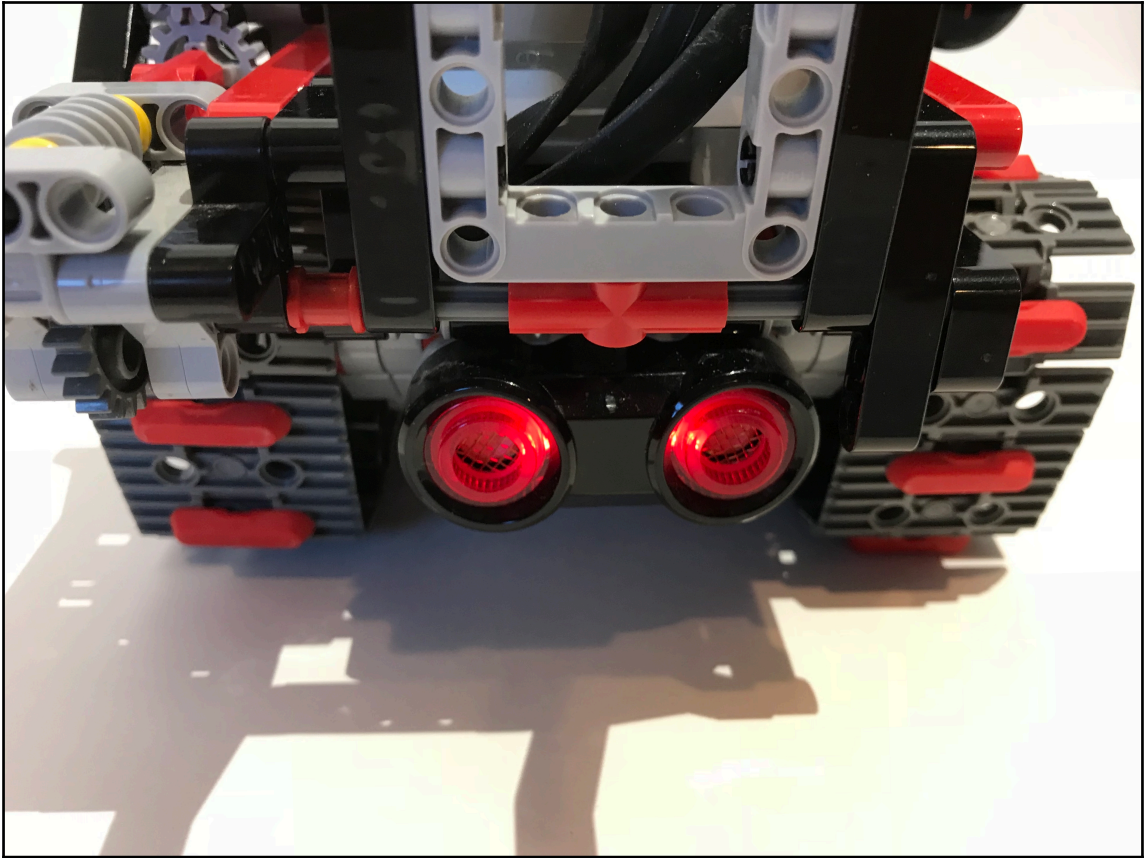

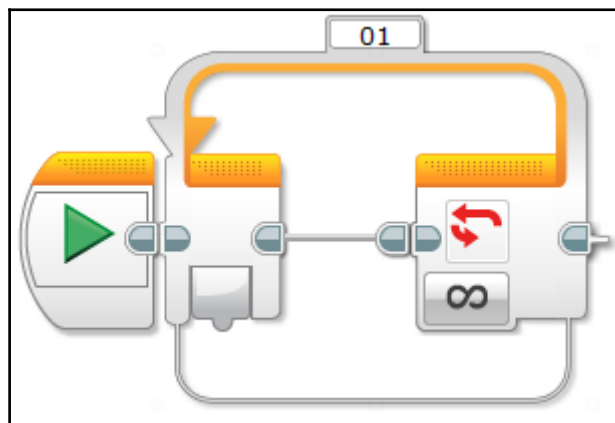
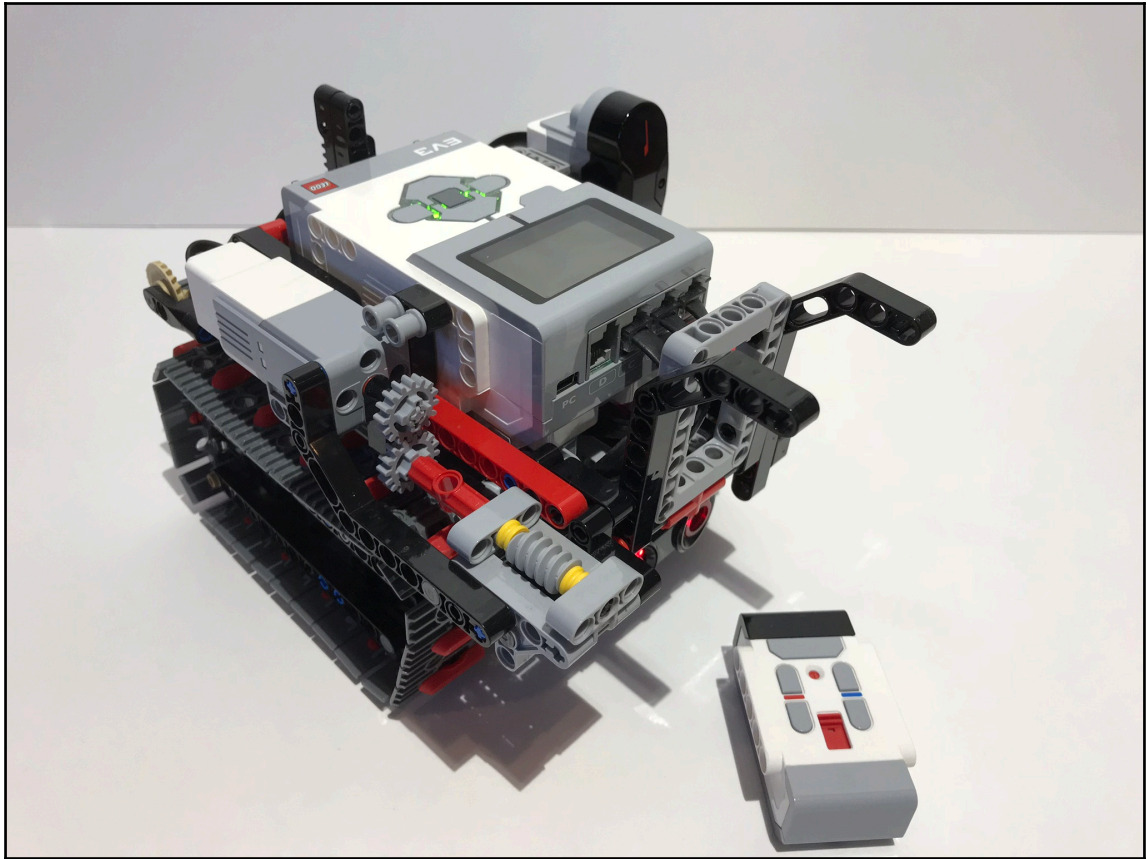

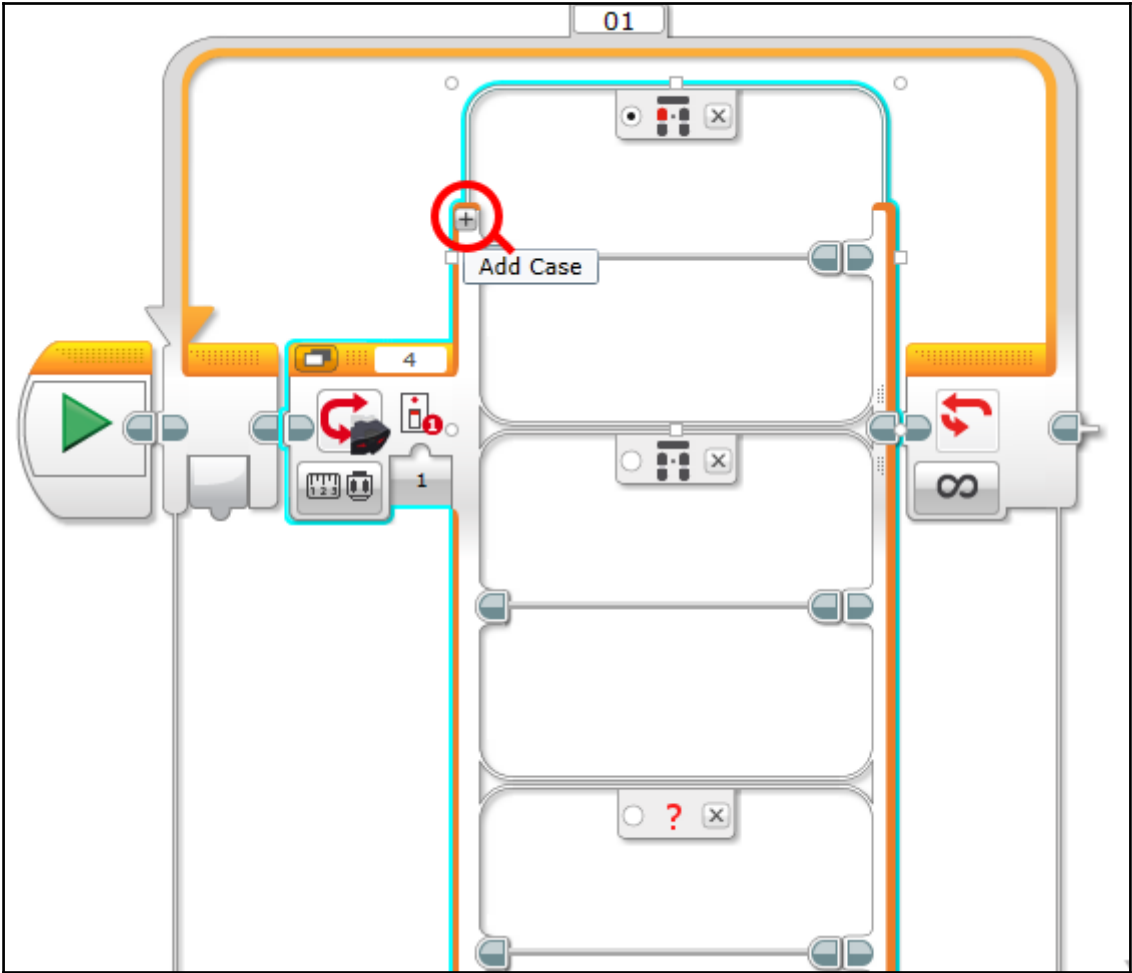

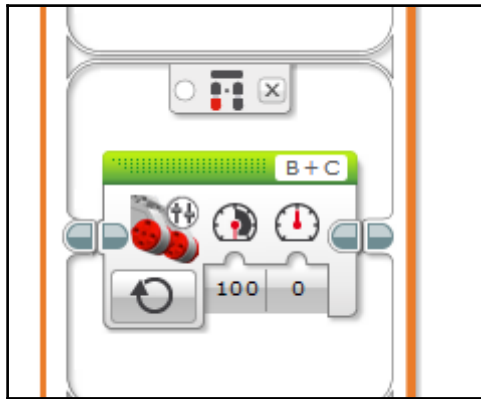
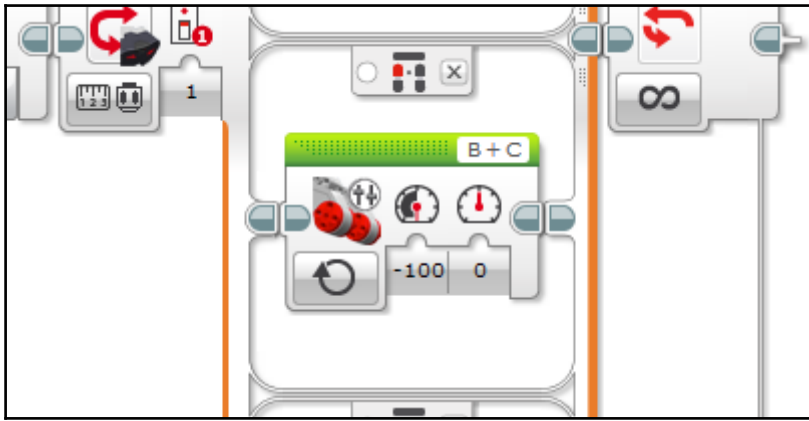
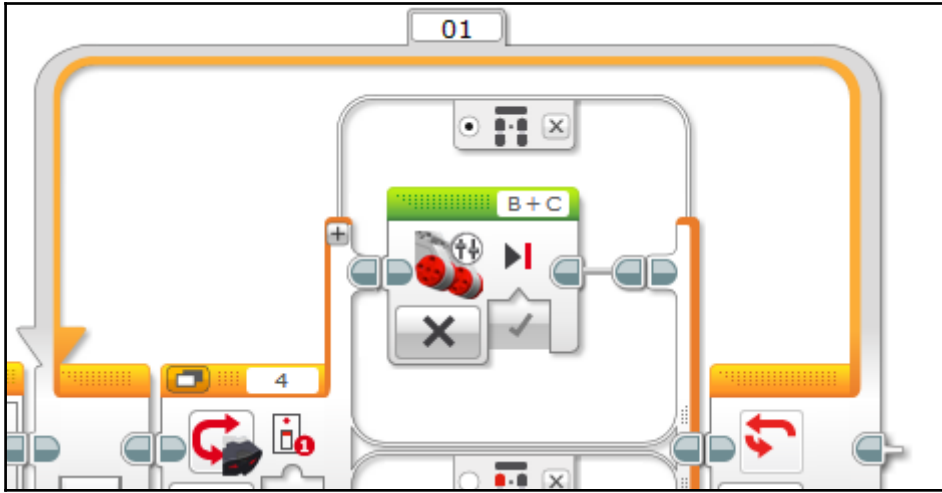

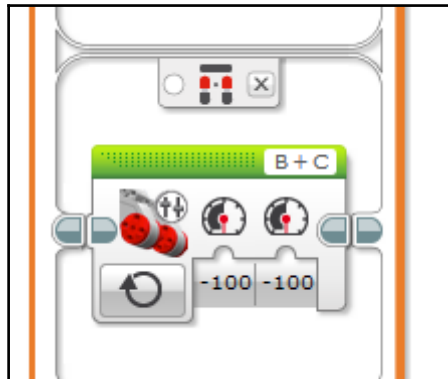
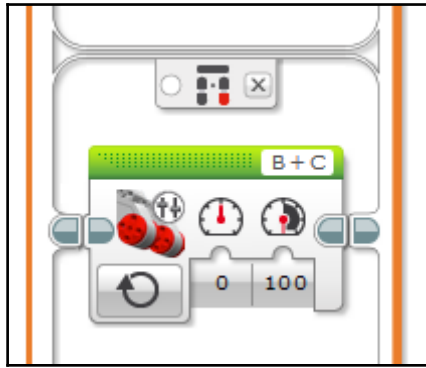
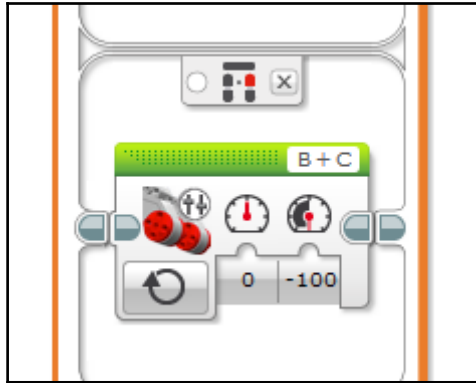

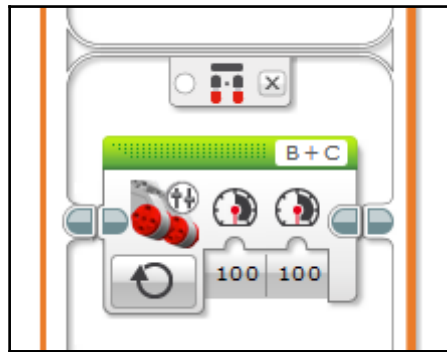
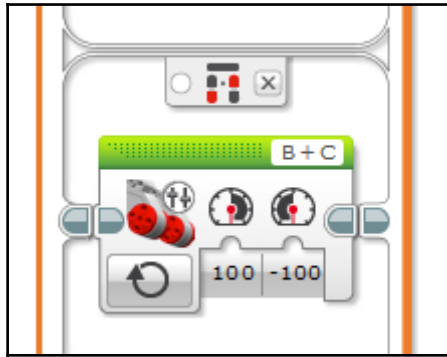
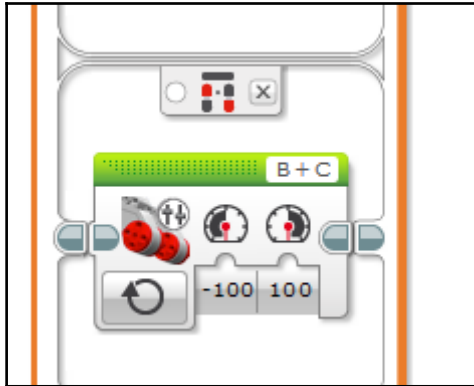

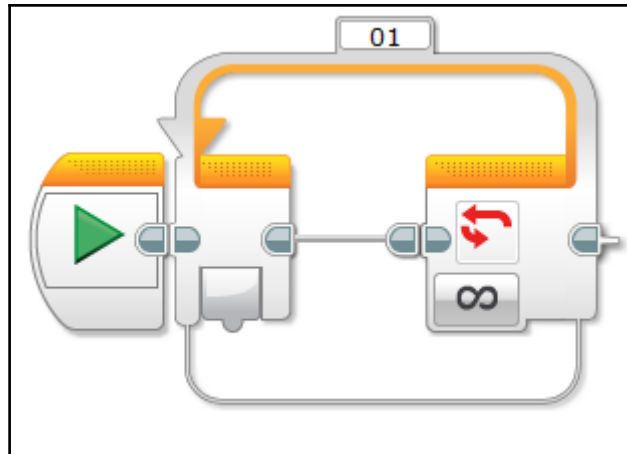
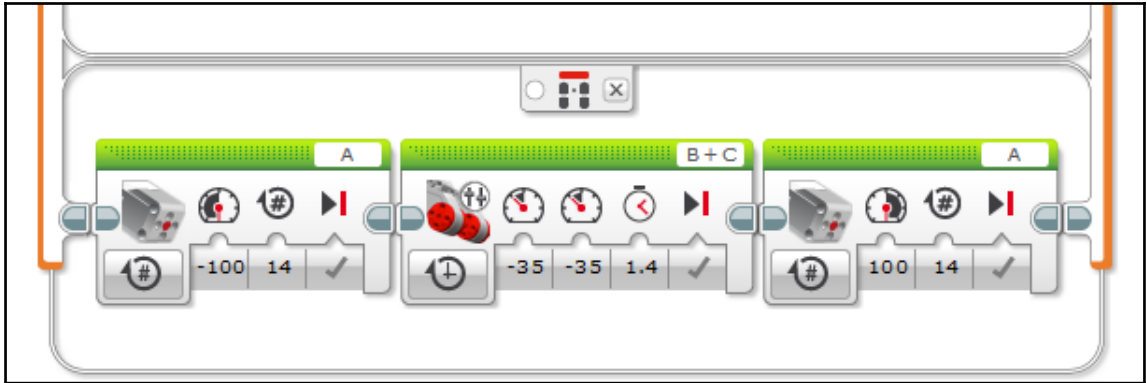

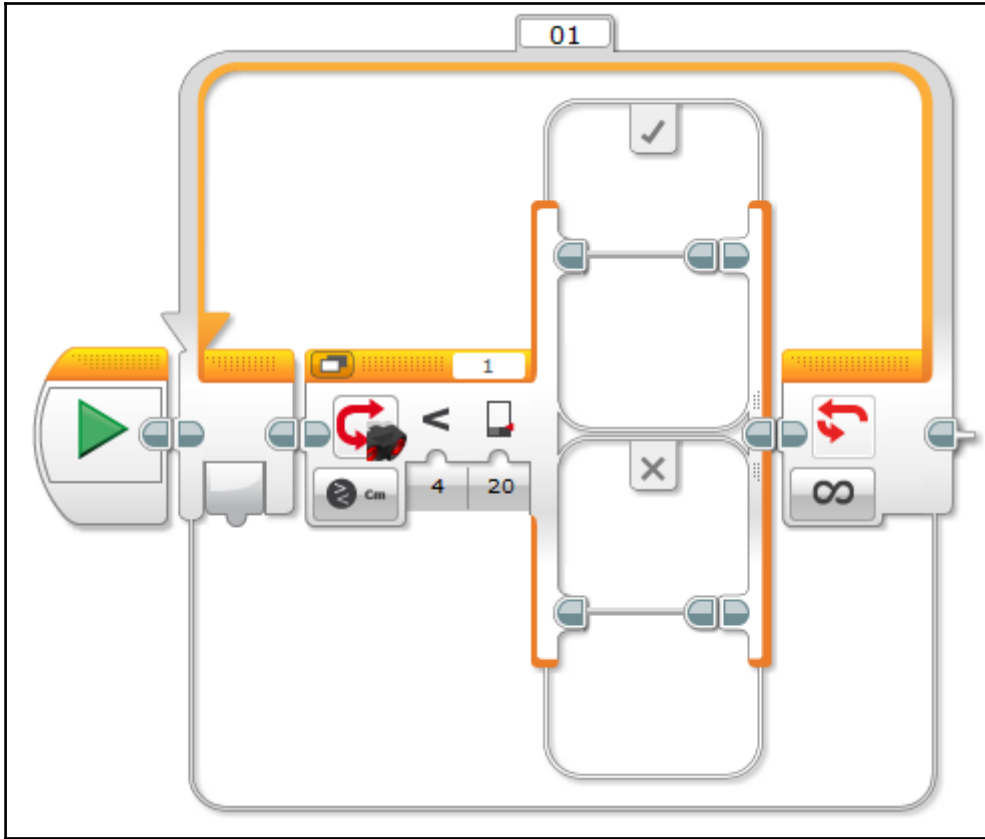

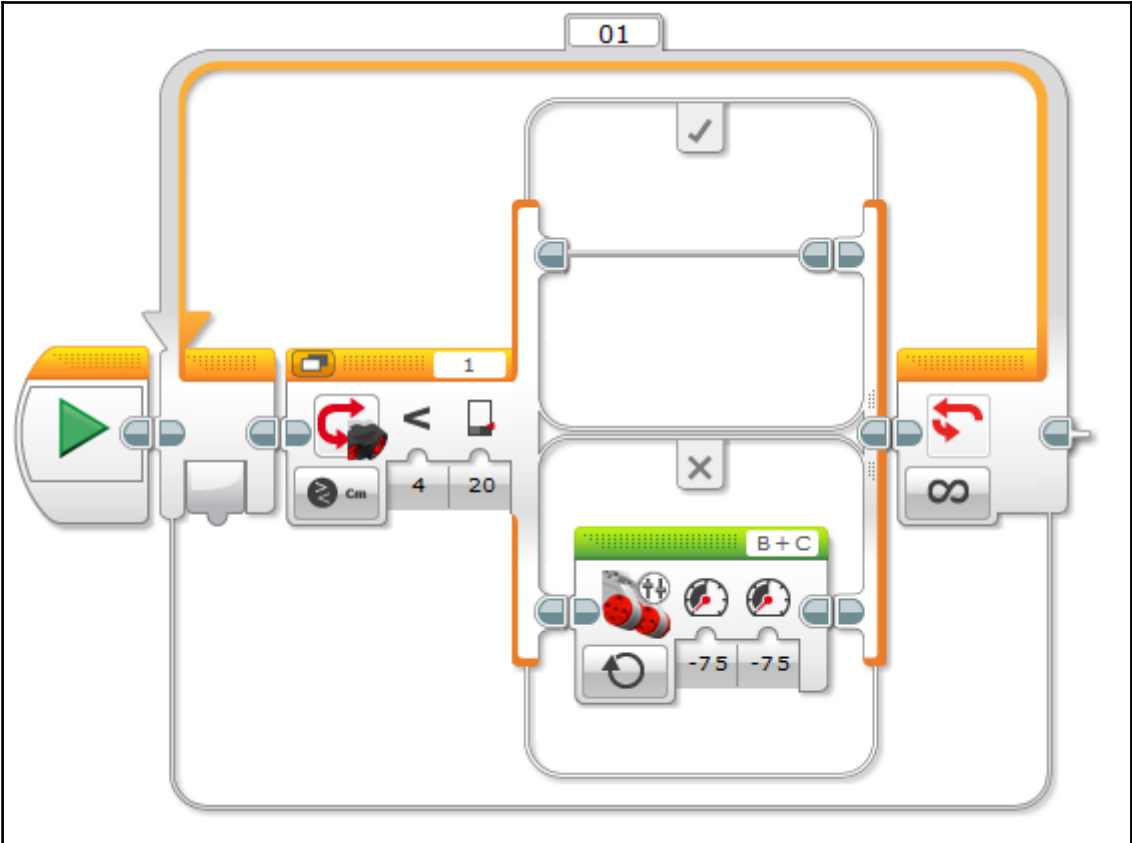

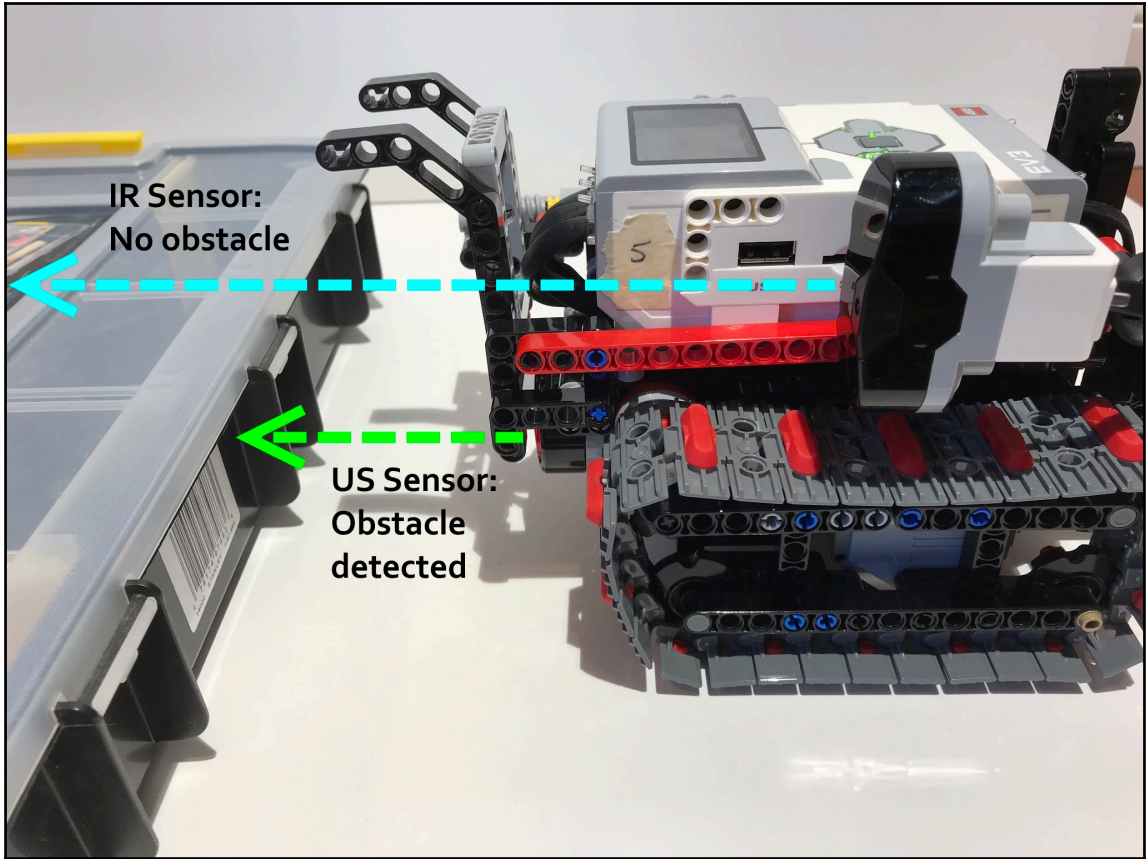

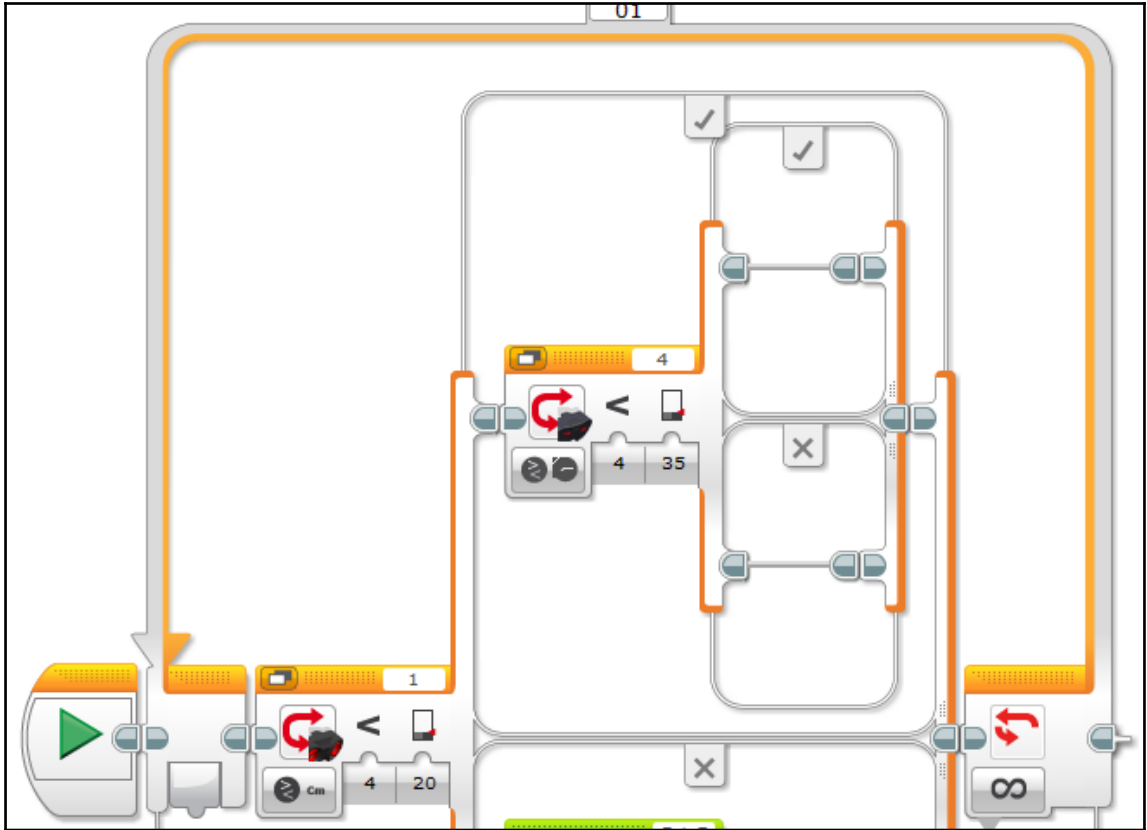

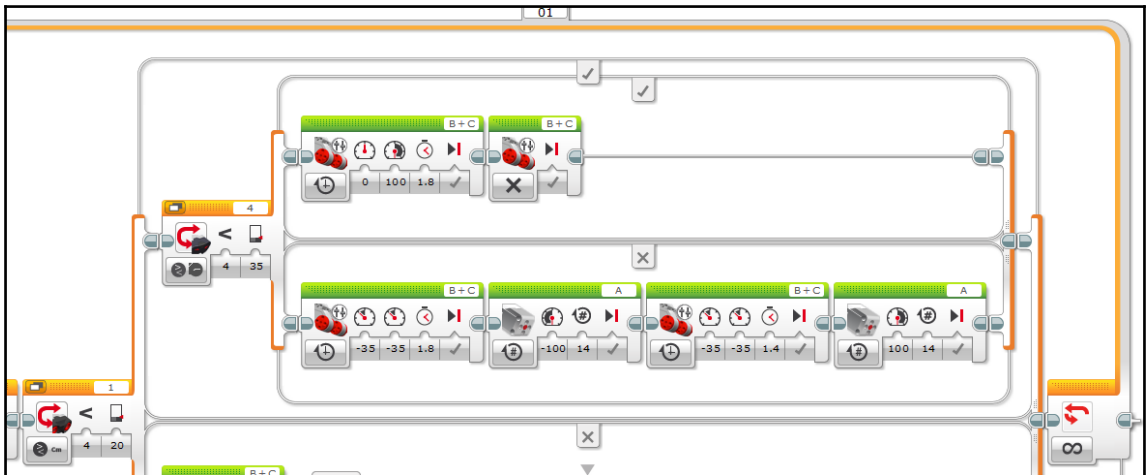
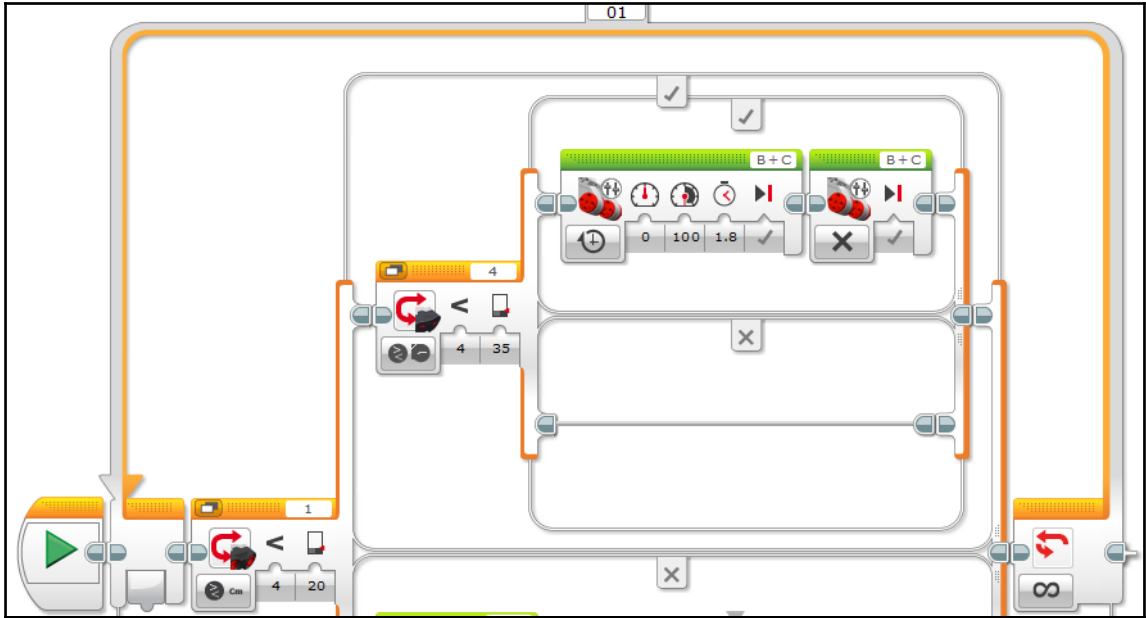

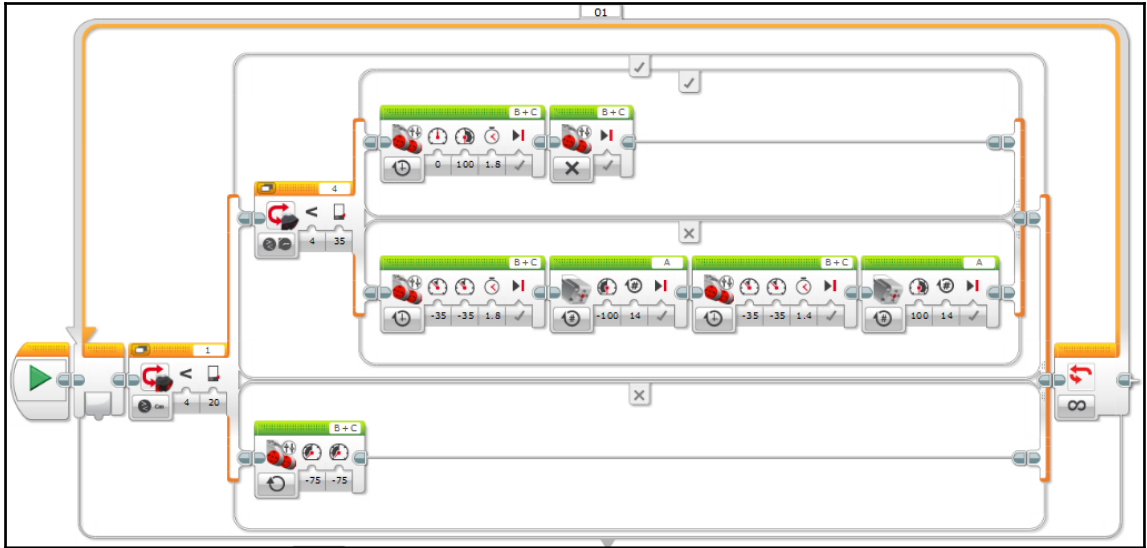

Chapter 04: Timmyton – Interactive Robotic Shark



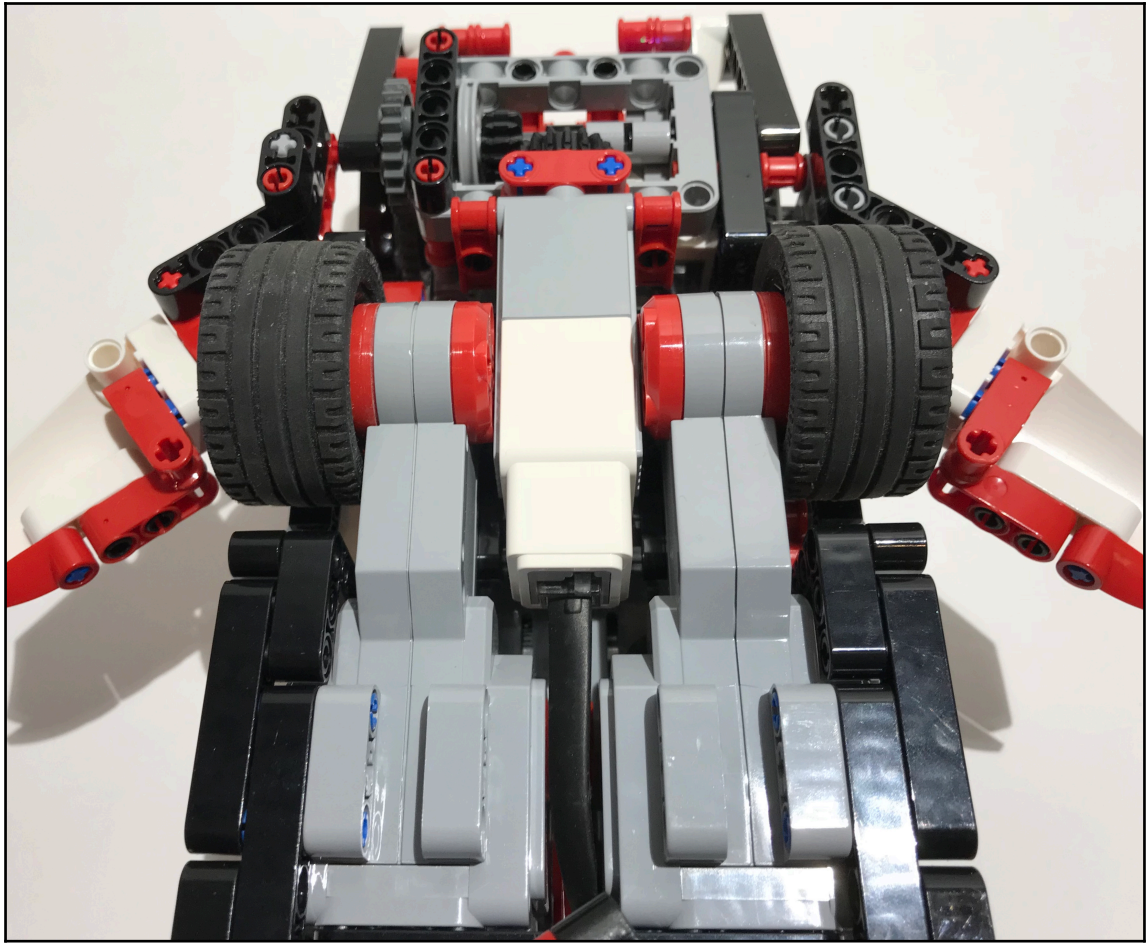

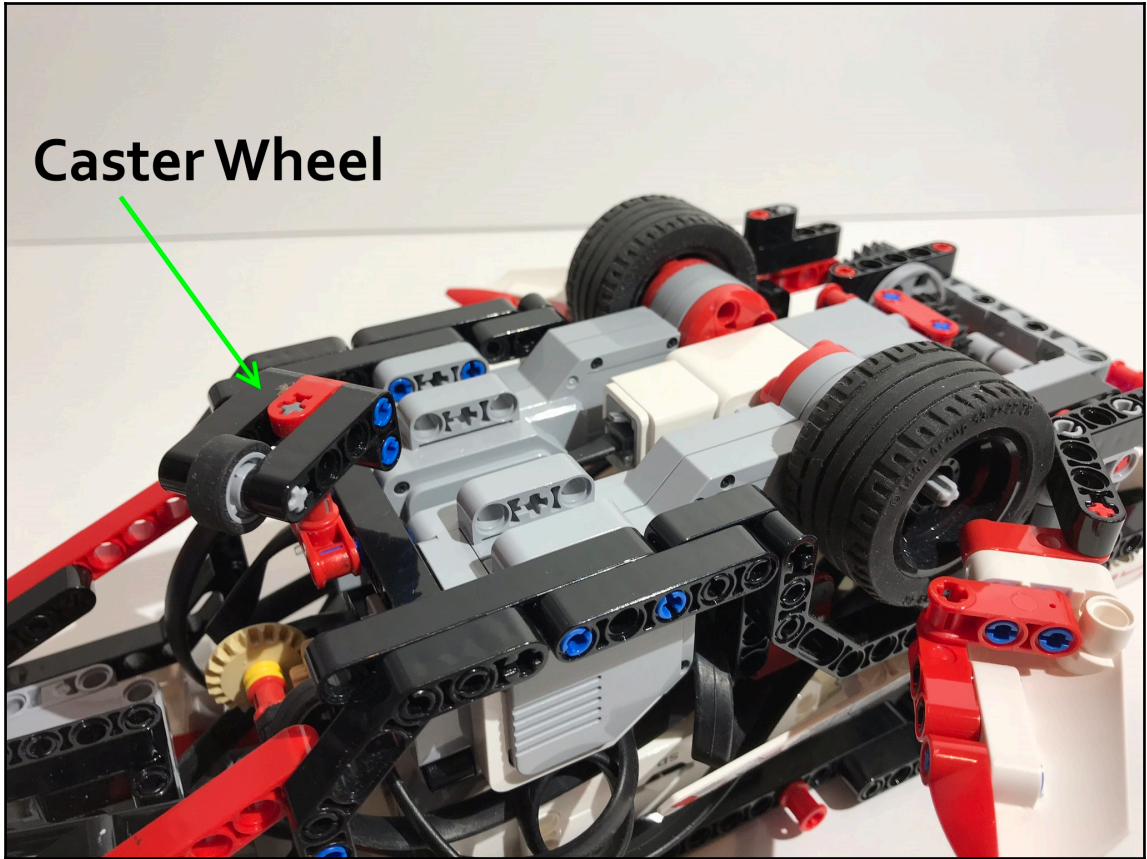







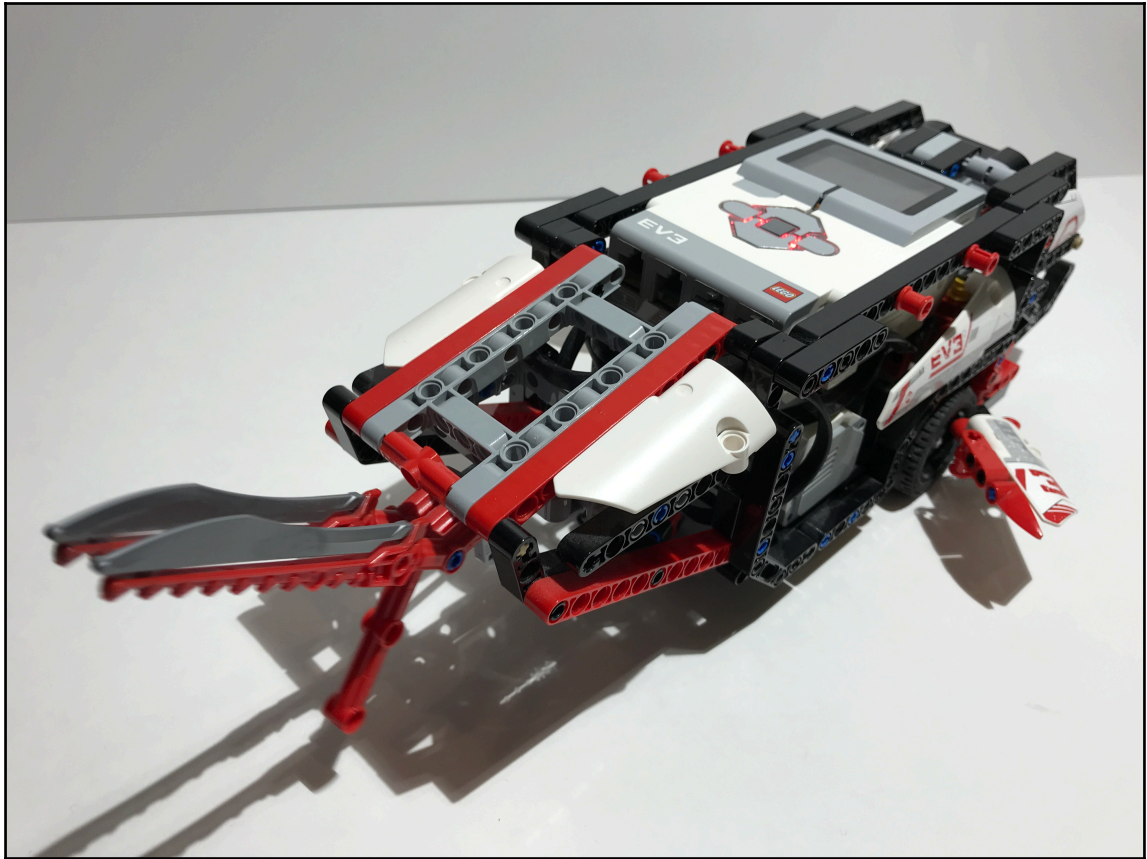

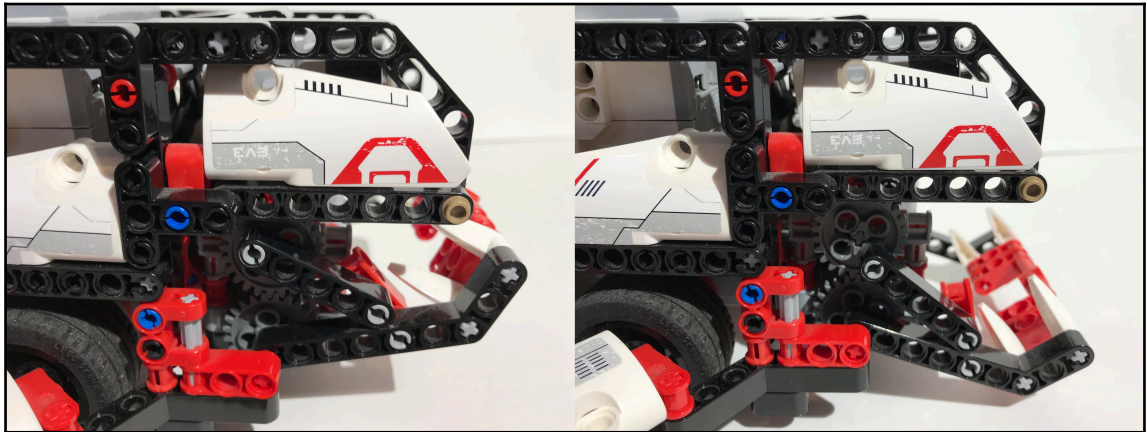
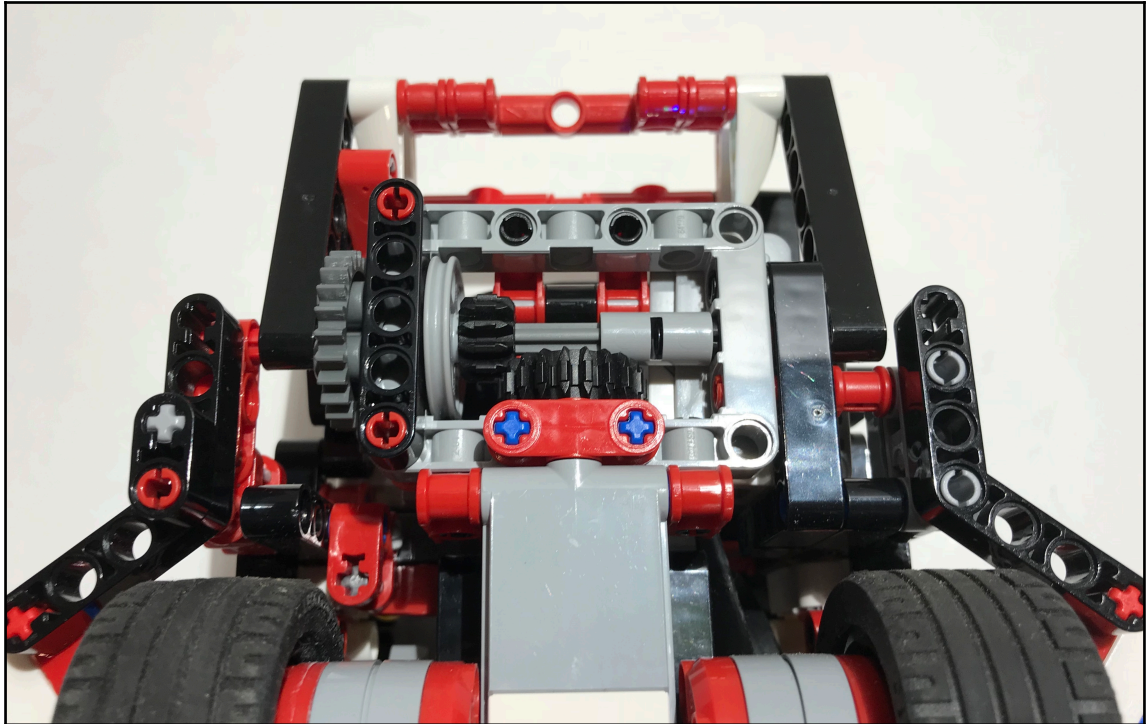

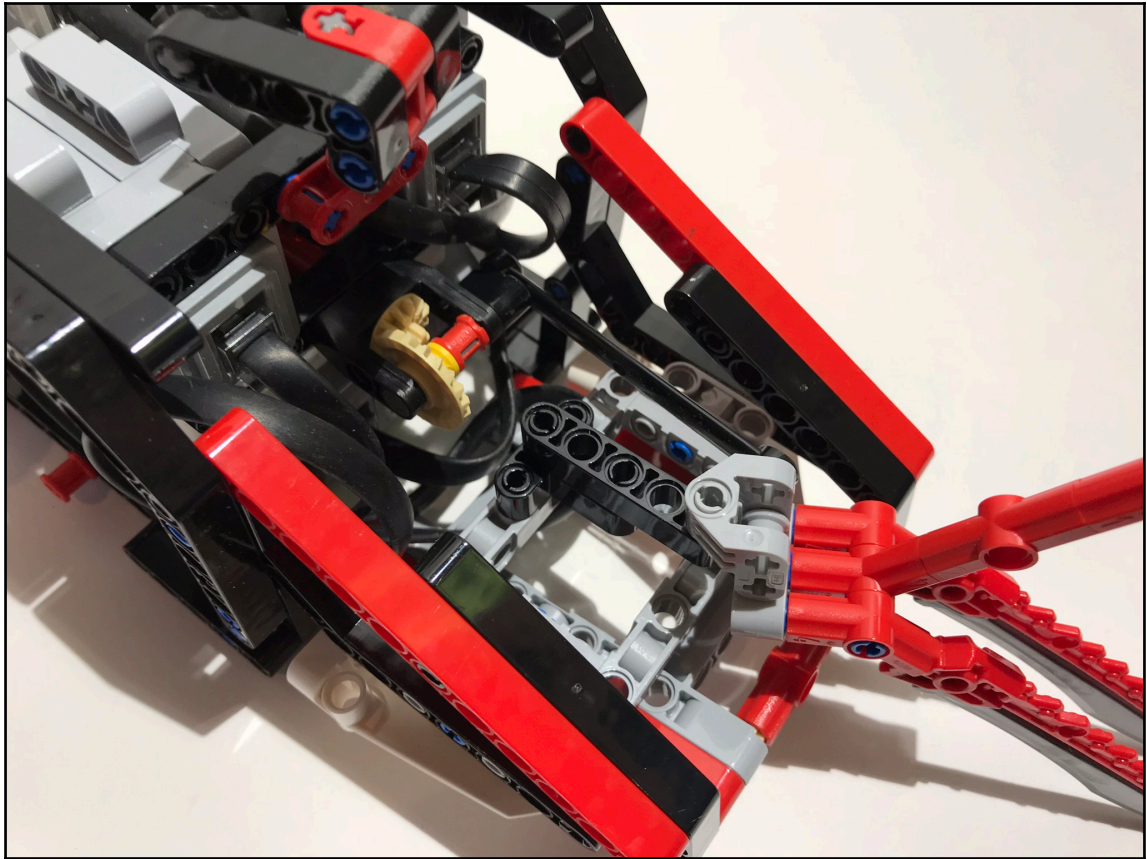

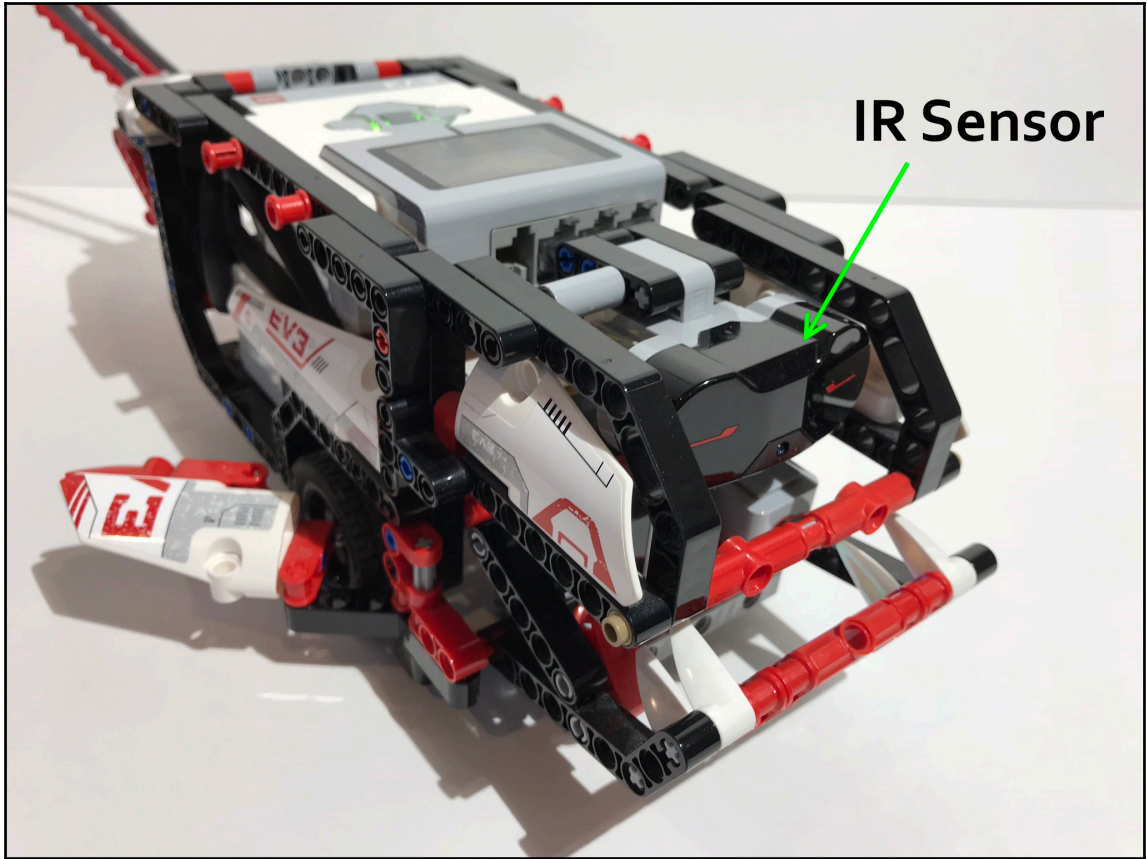

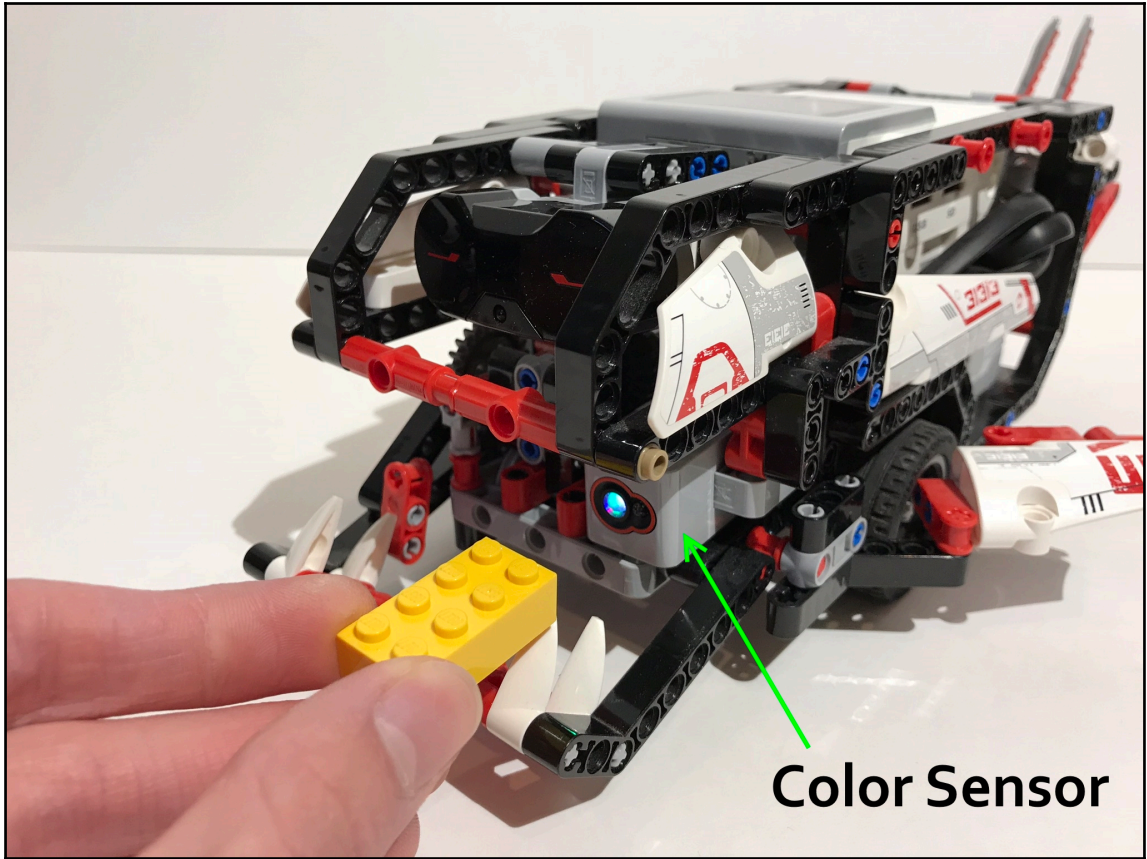

Color Sensor



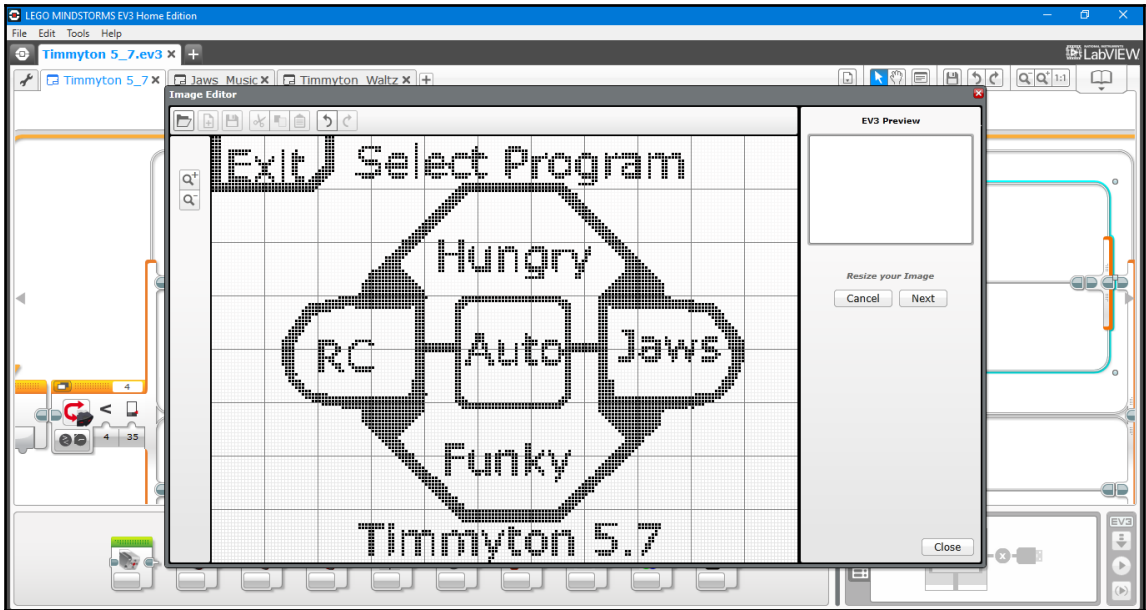

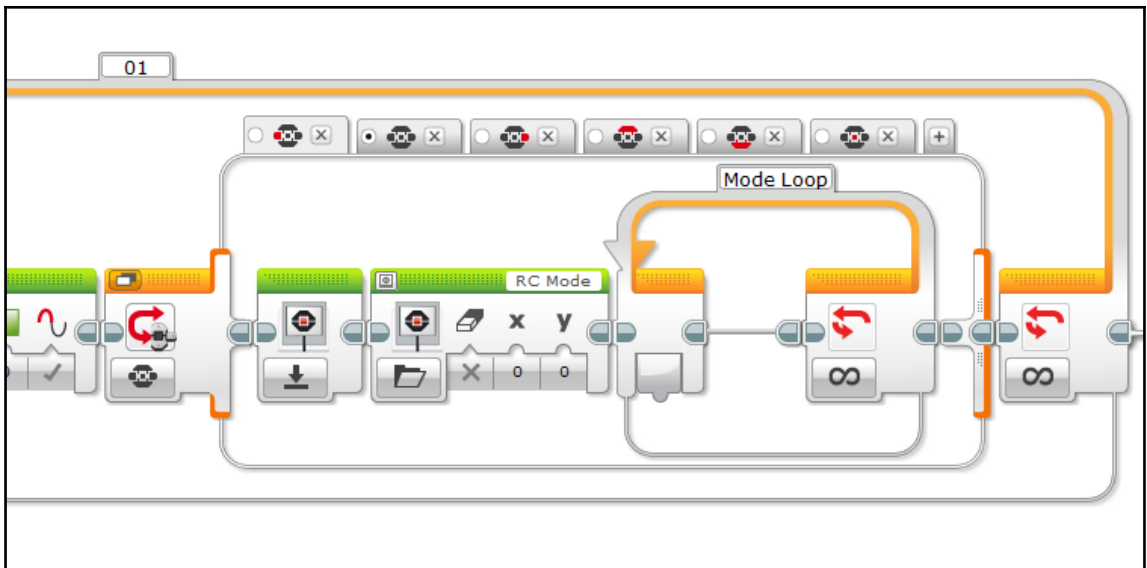
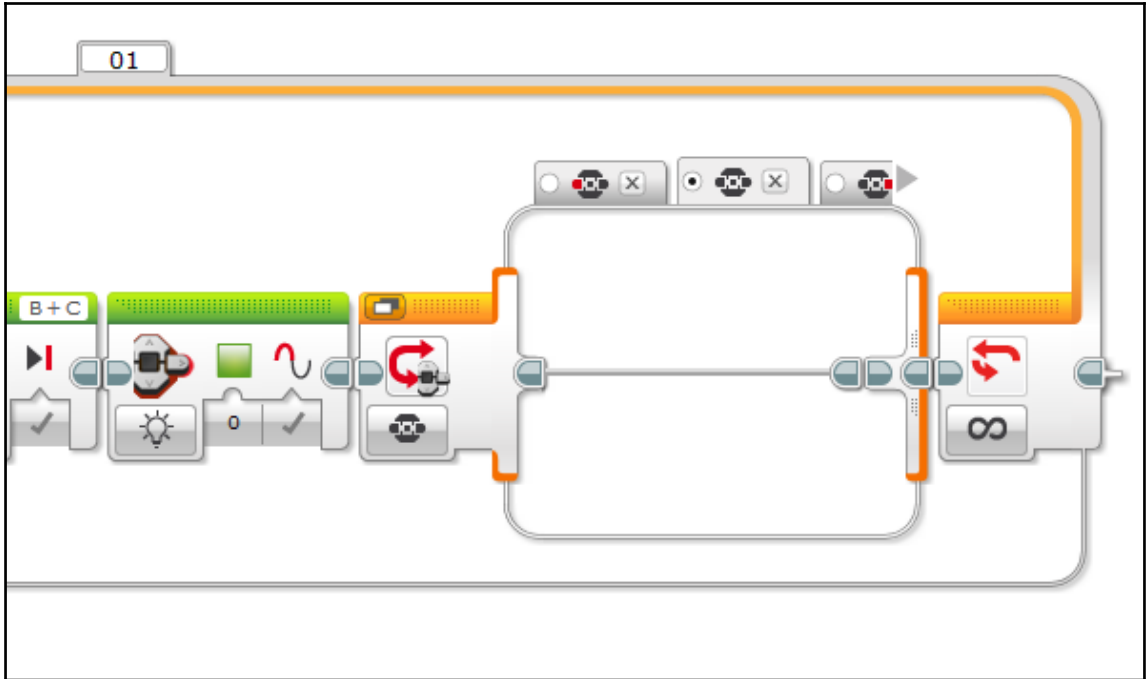

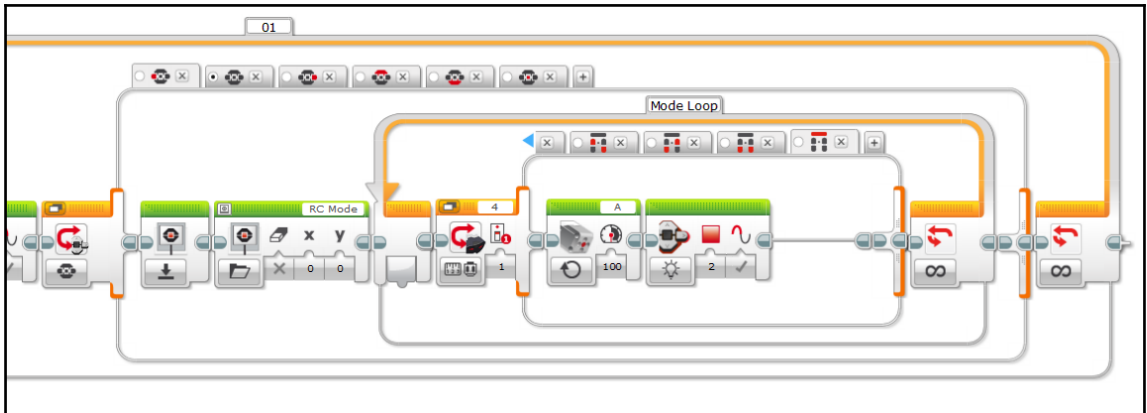
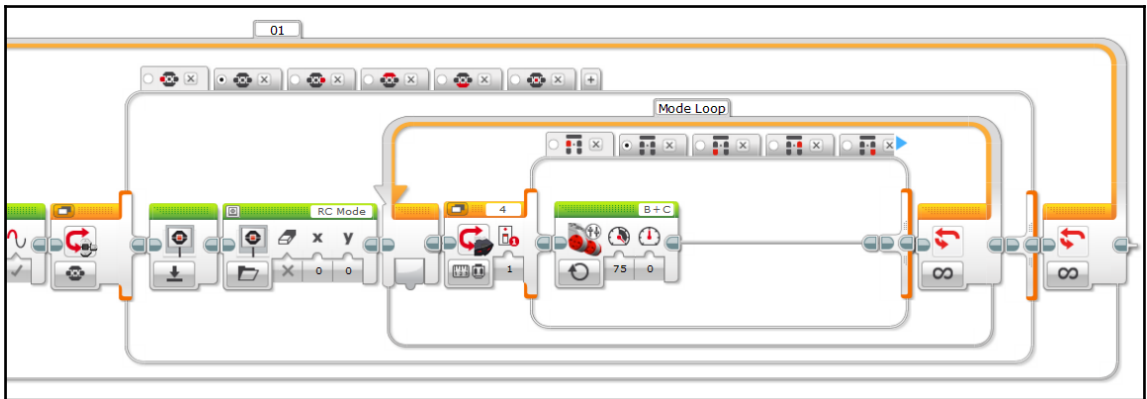
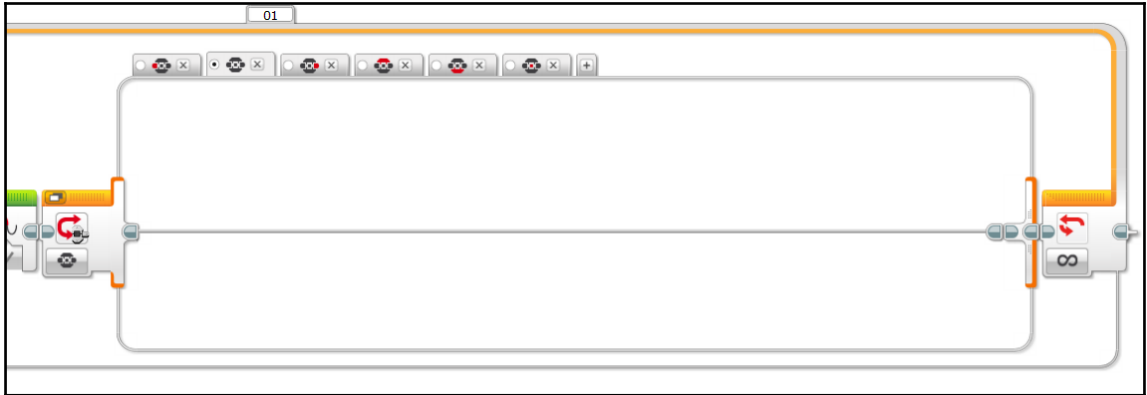

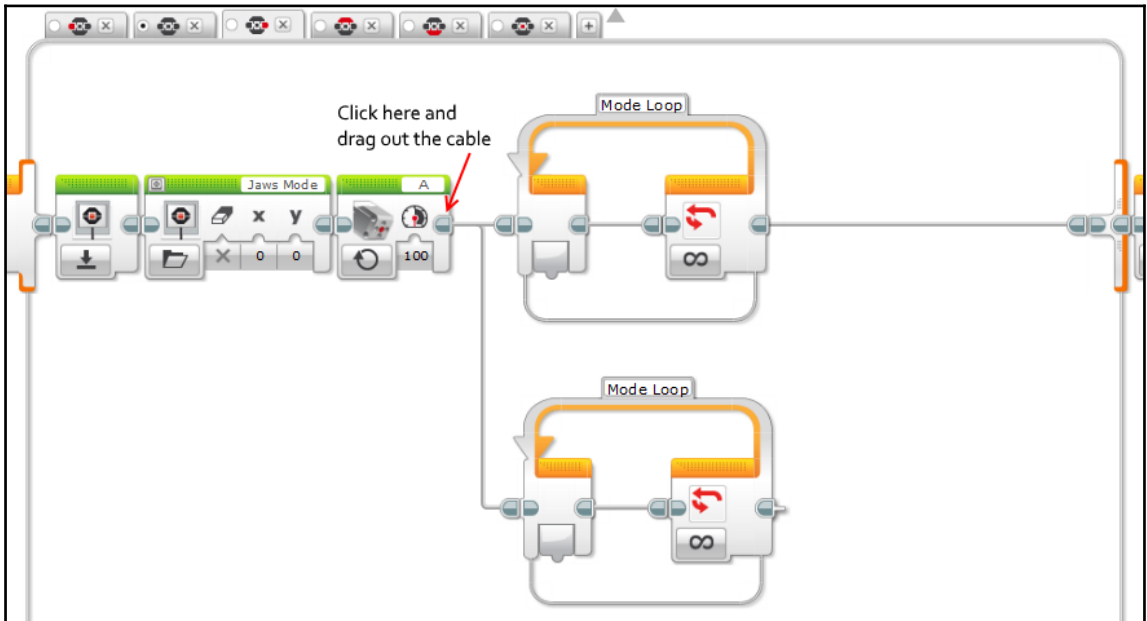
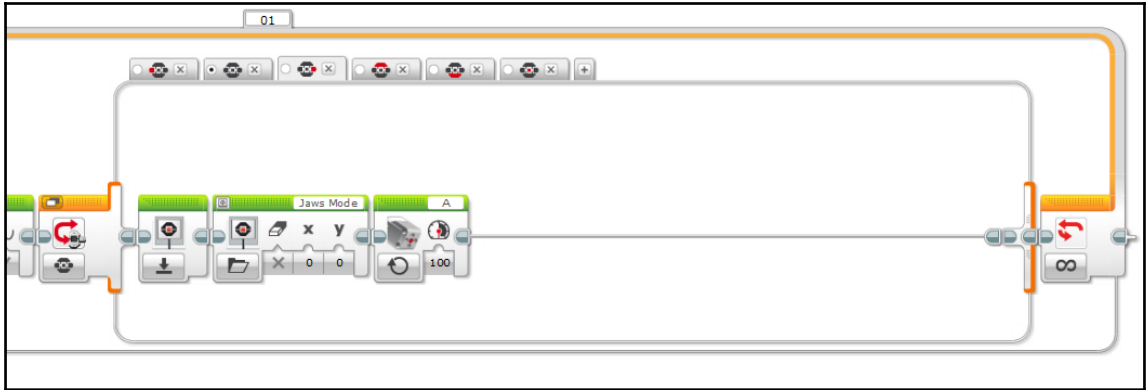

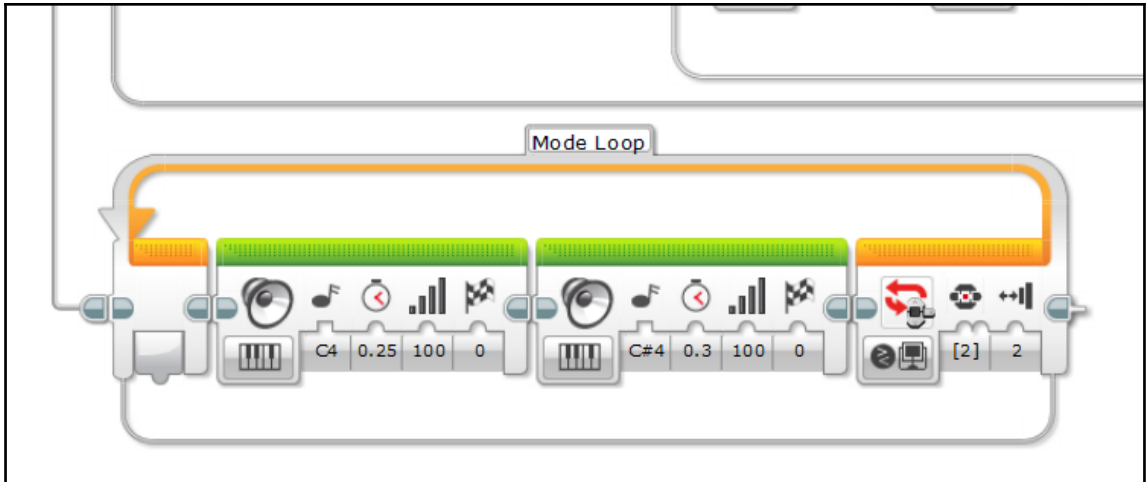
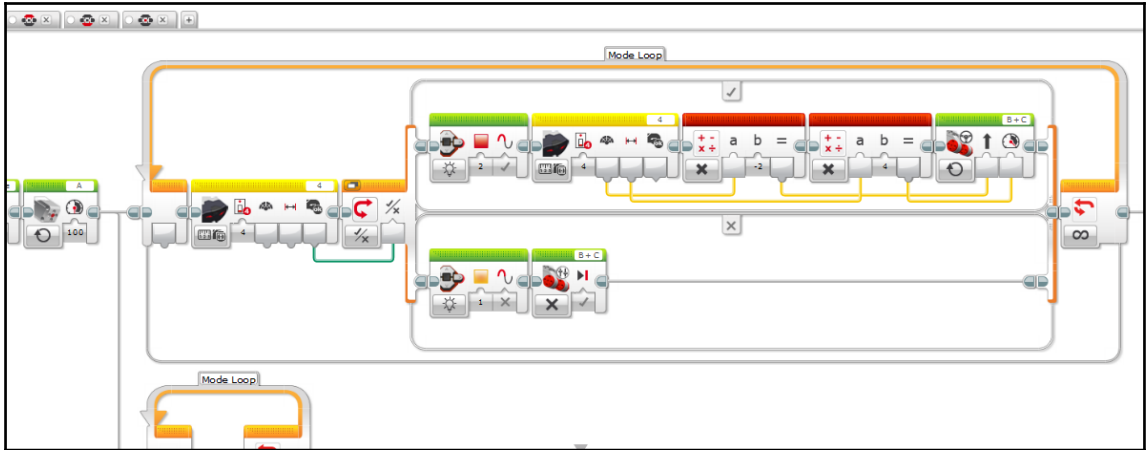

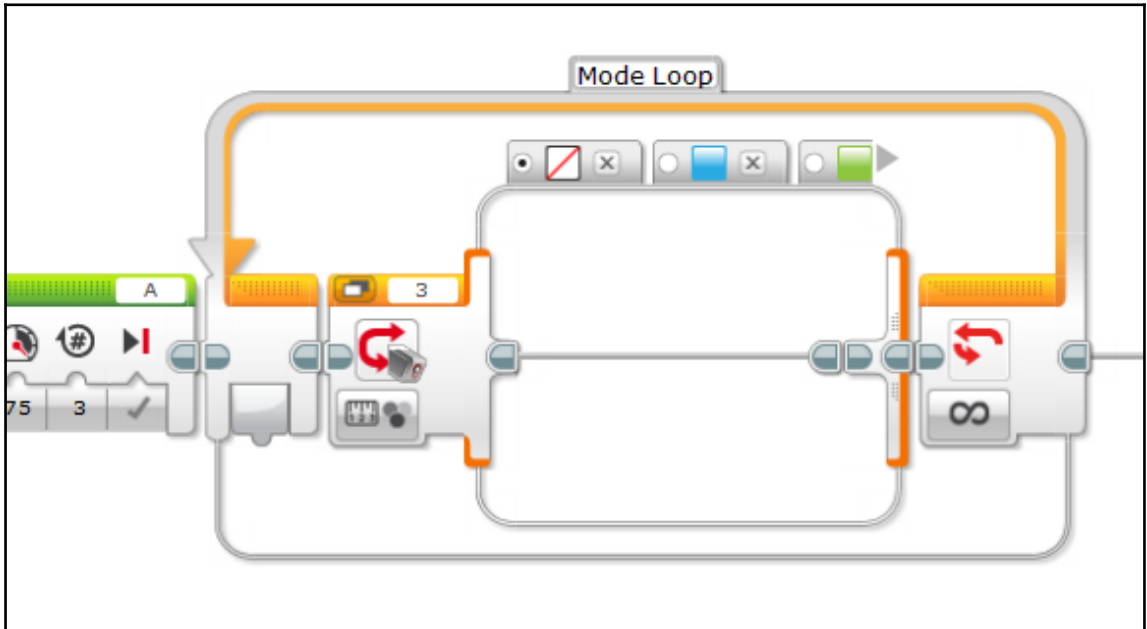
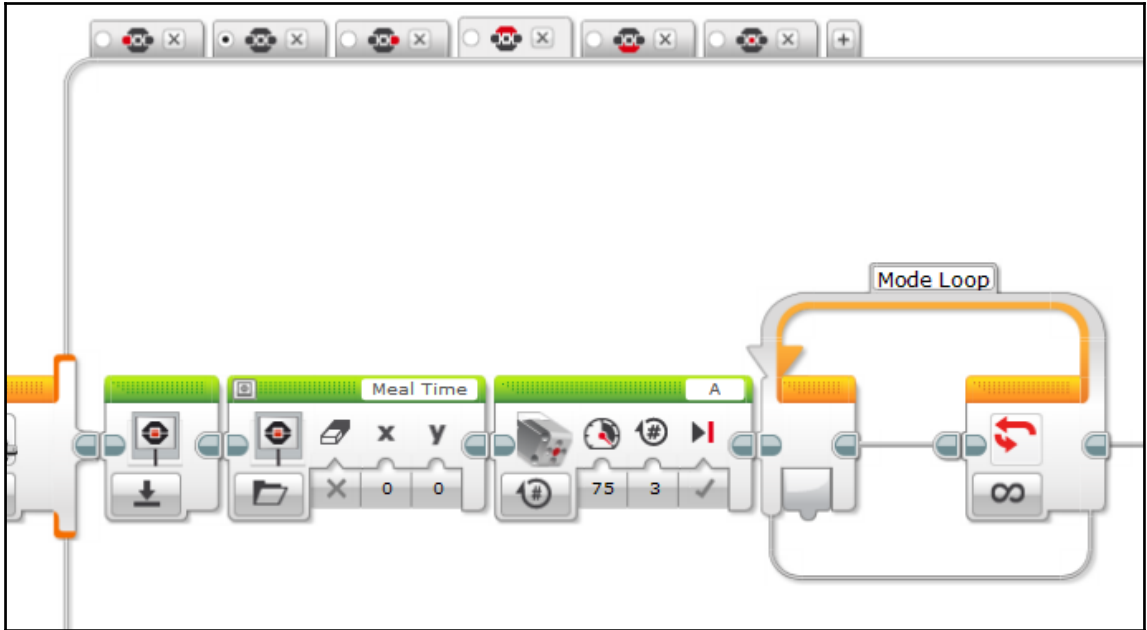

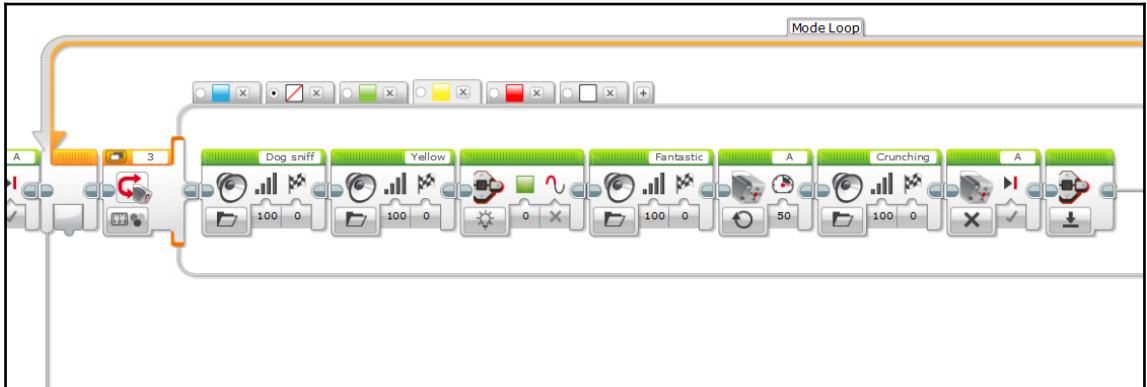
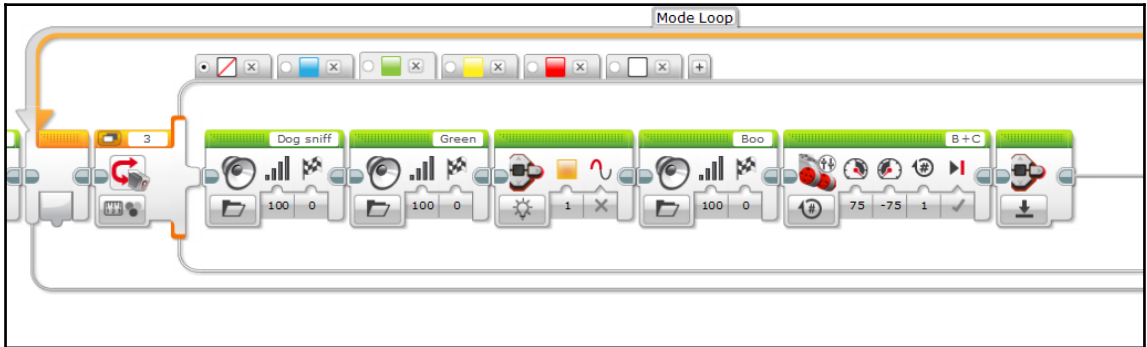
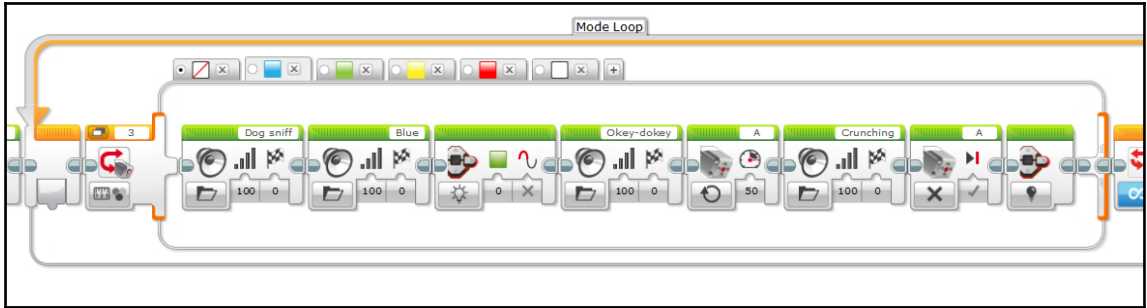

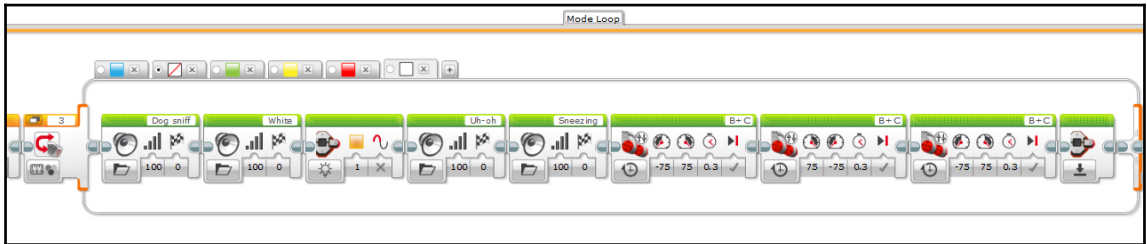
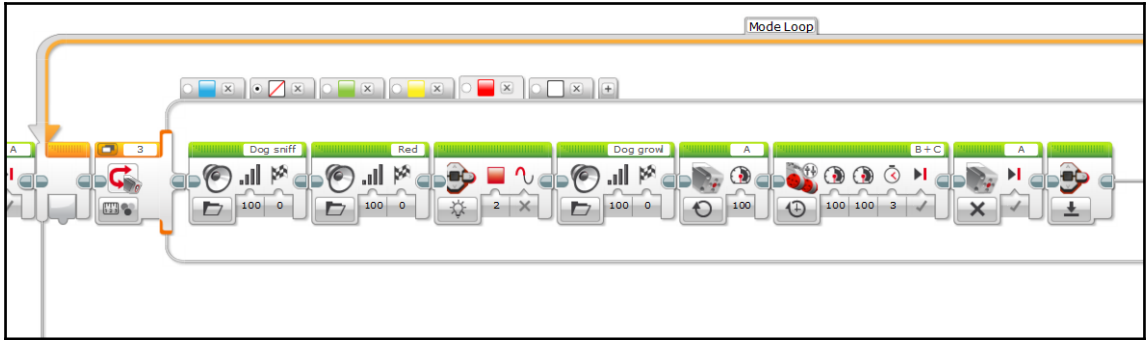

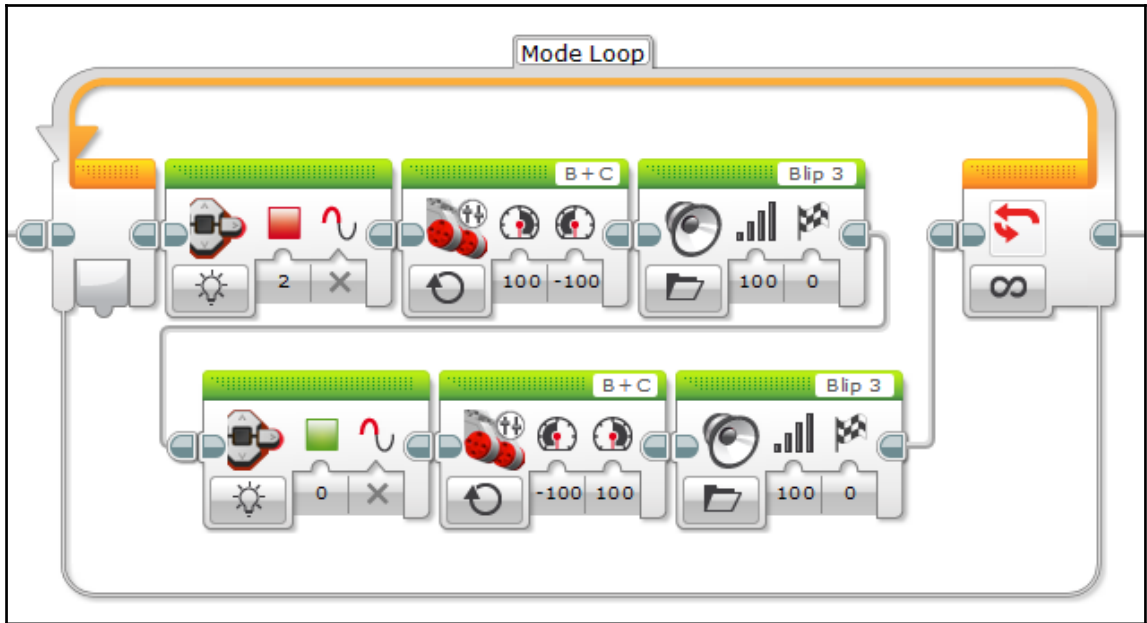

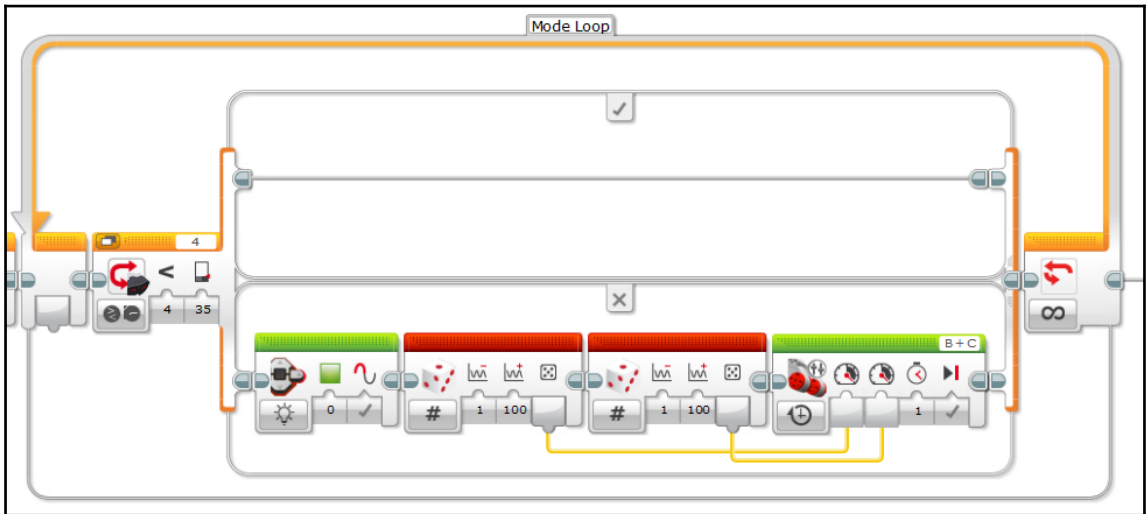
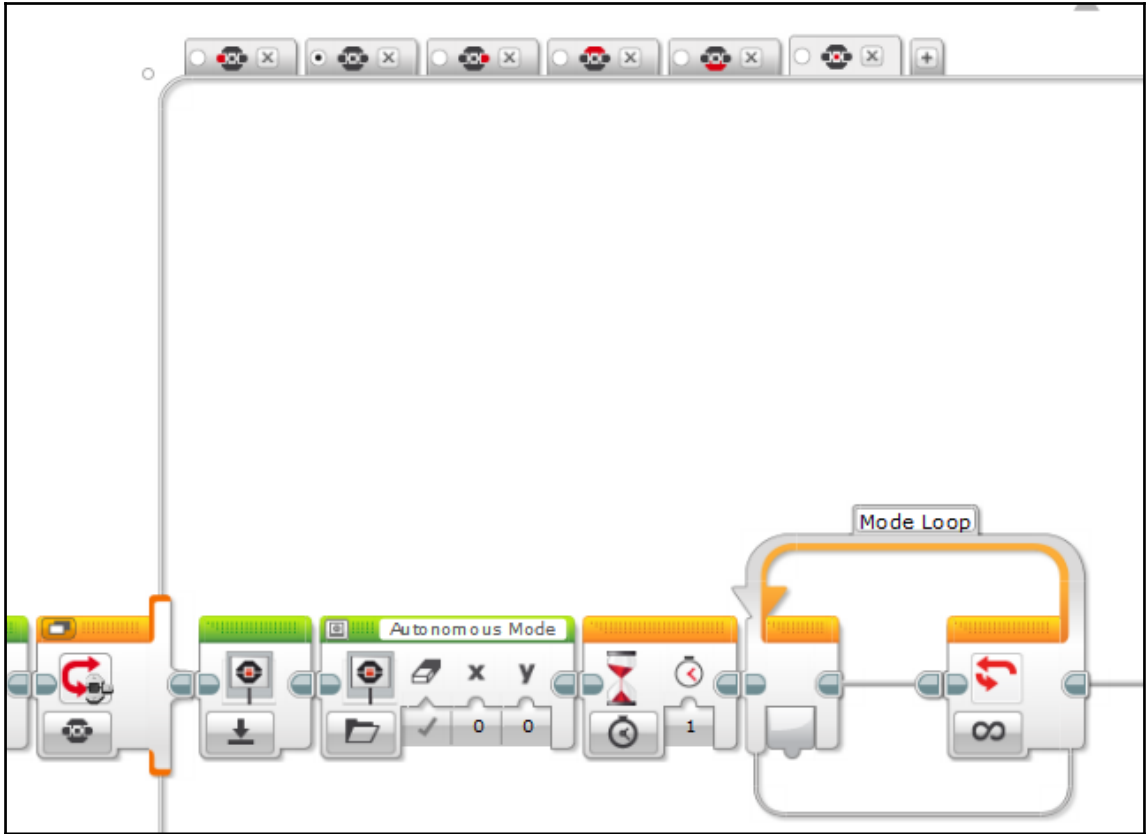

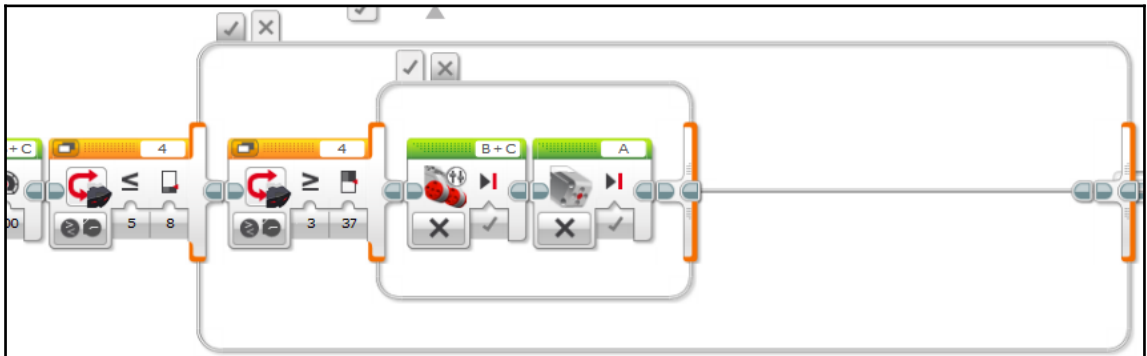
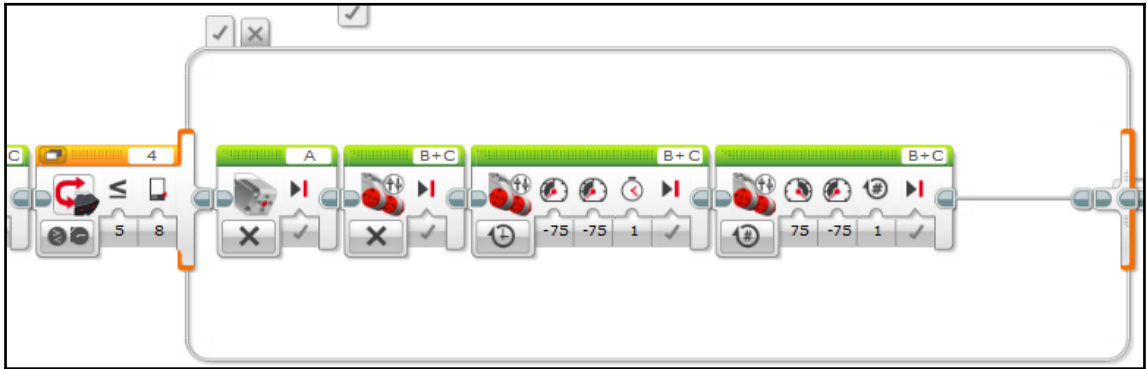
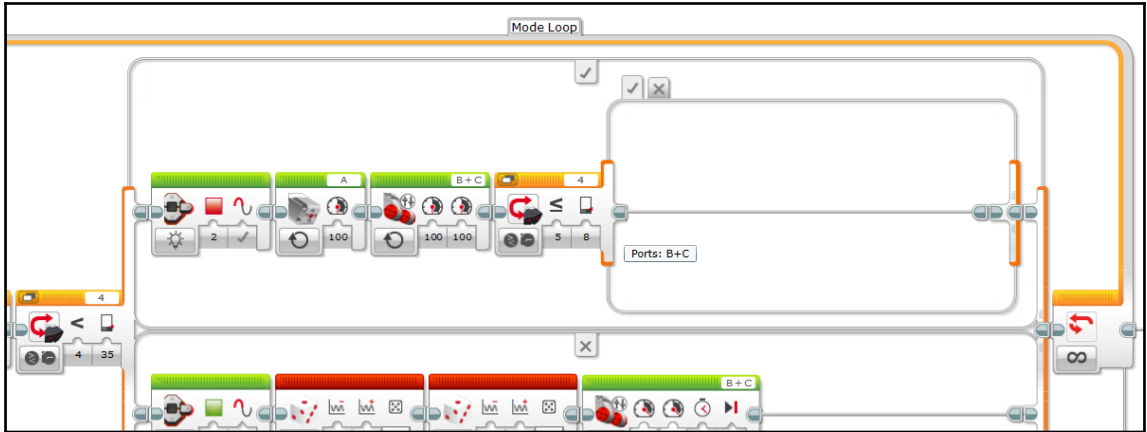

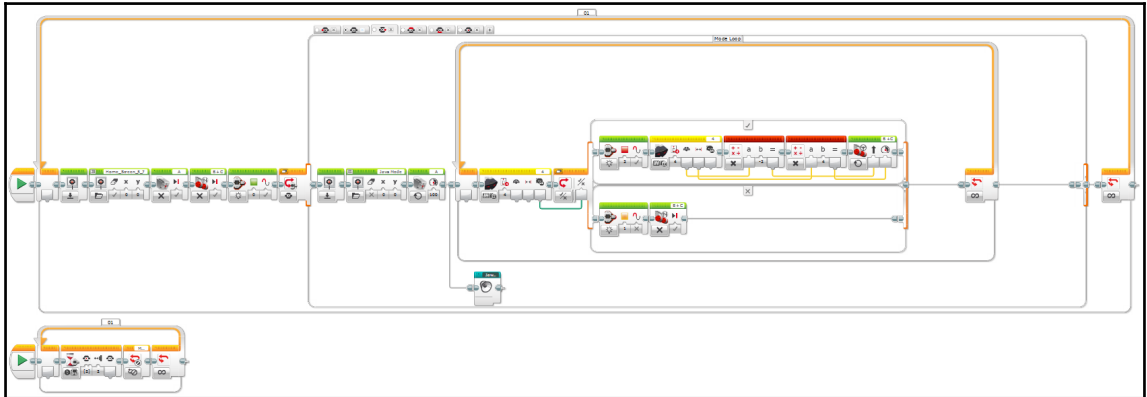
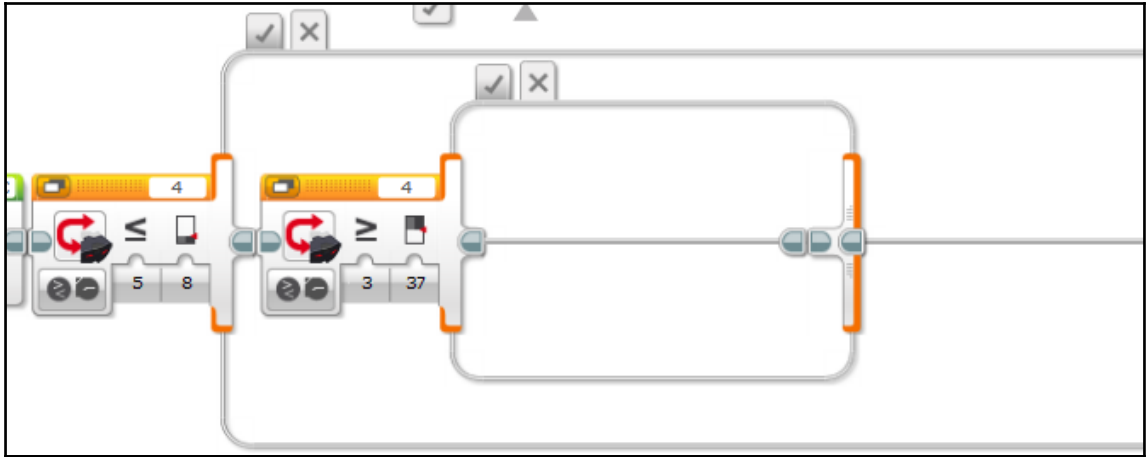

Chapter 05: Grunt – Quirky Bipedal Robot



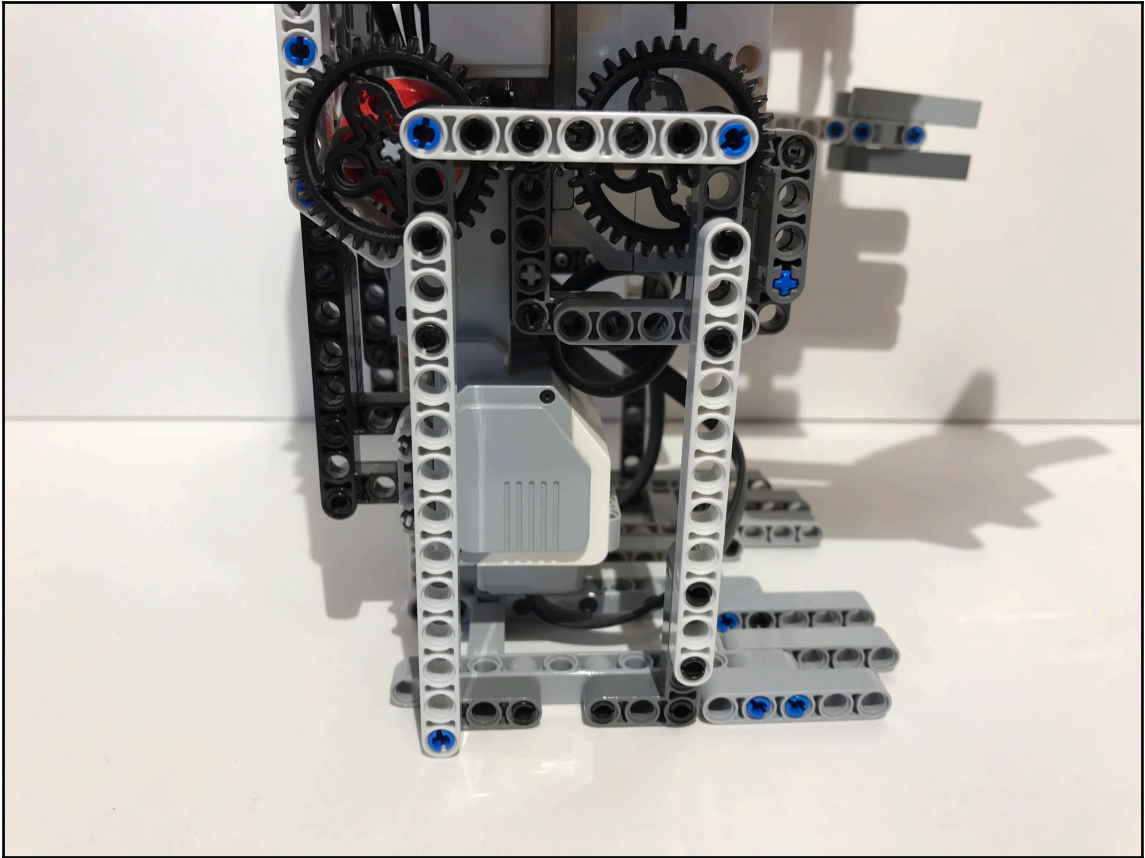

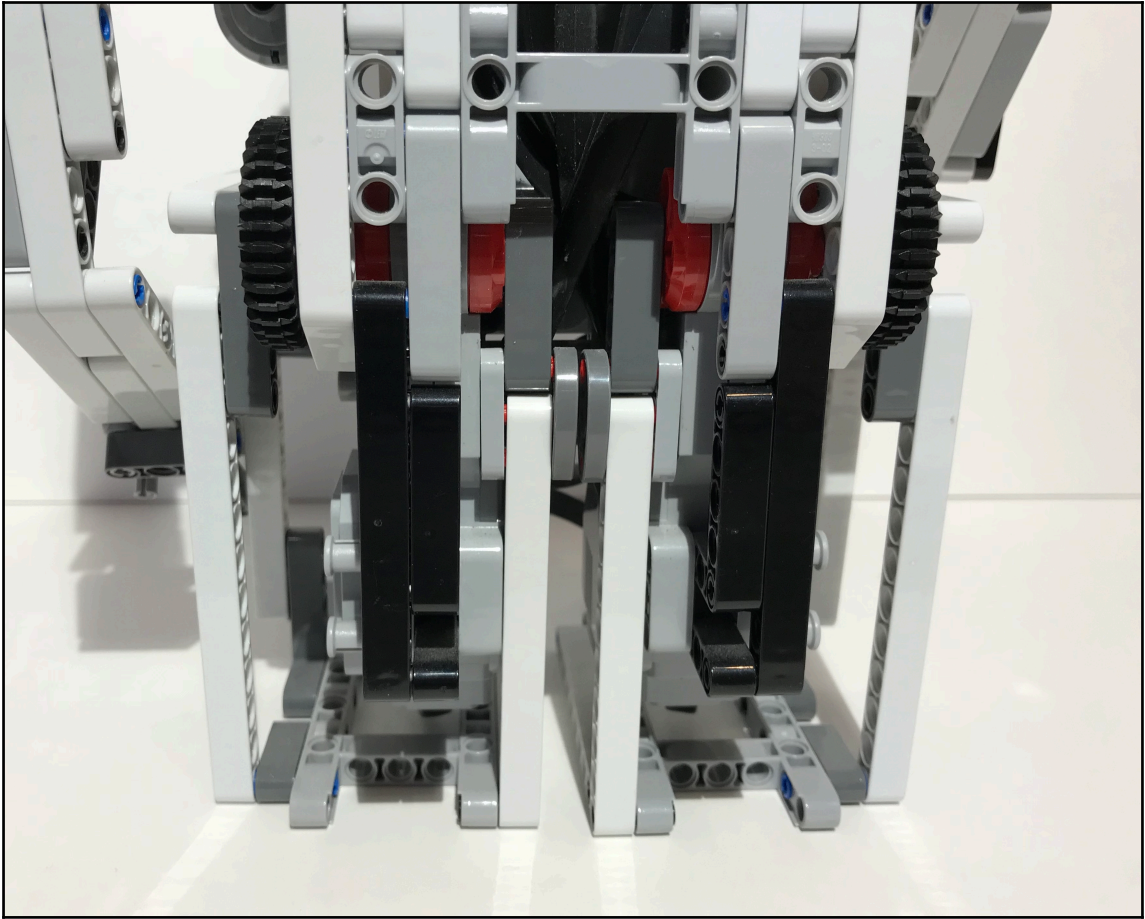

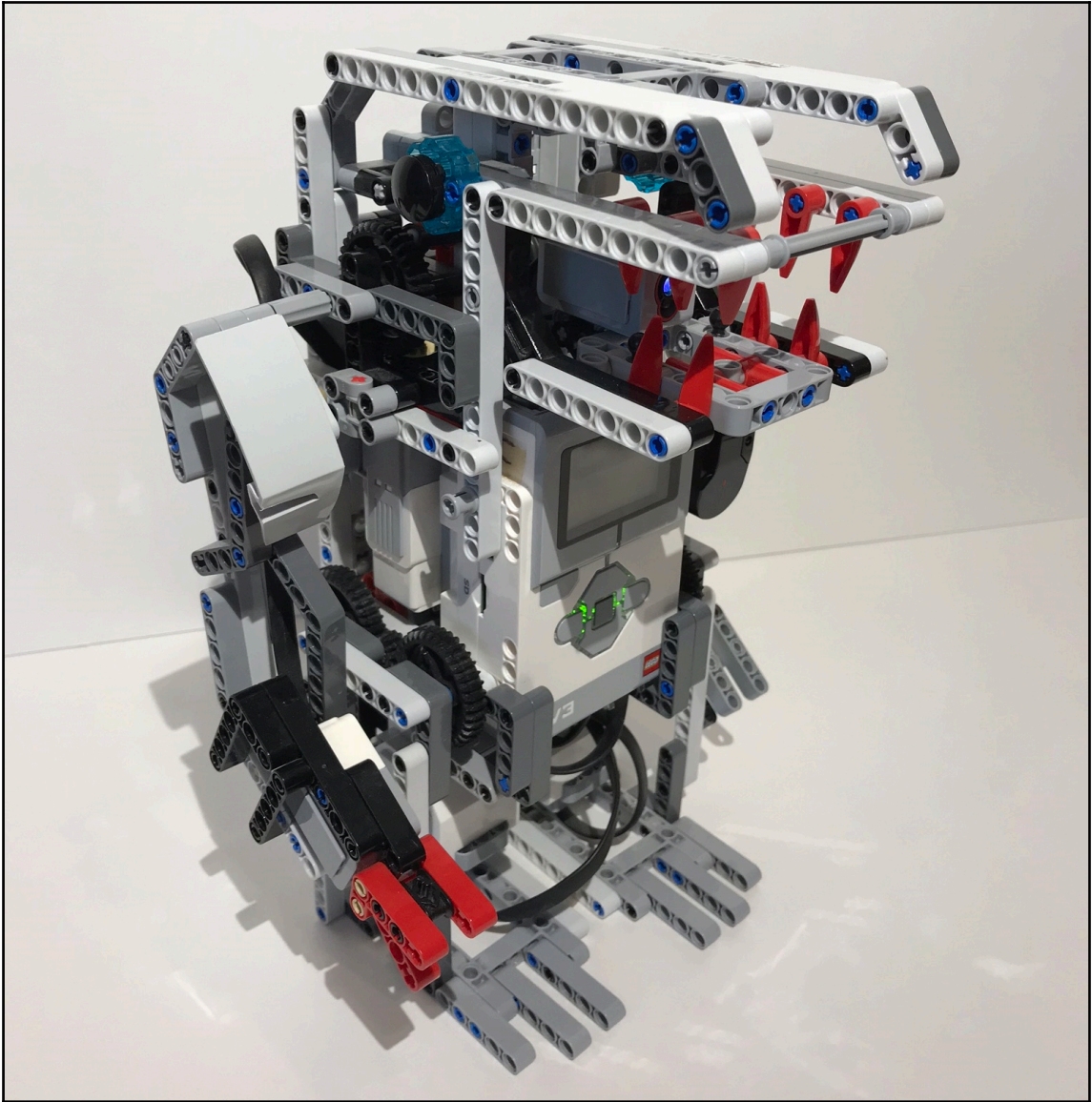

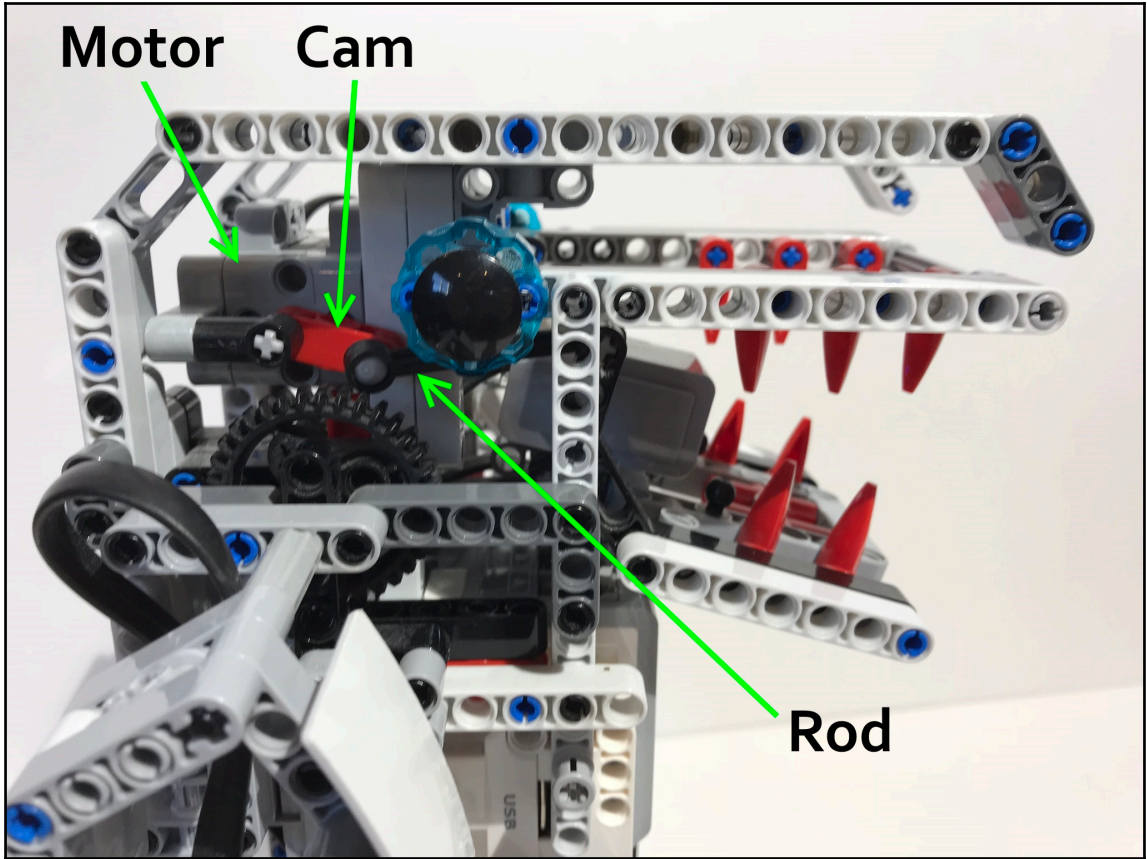

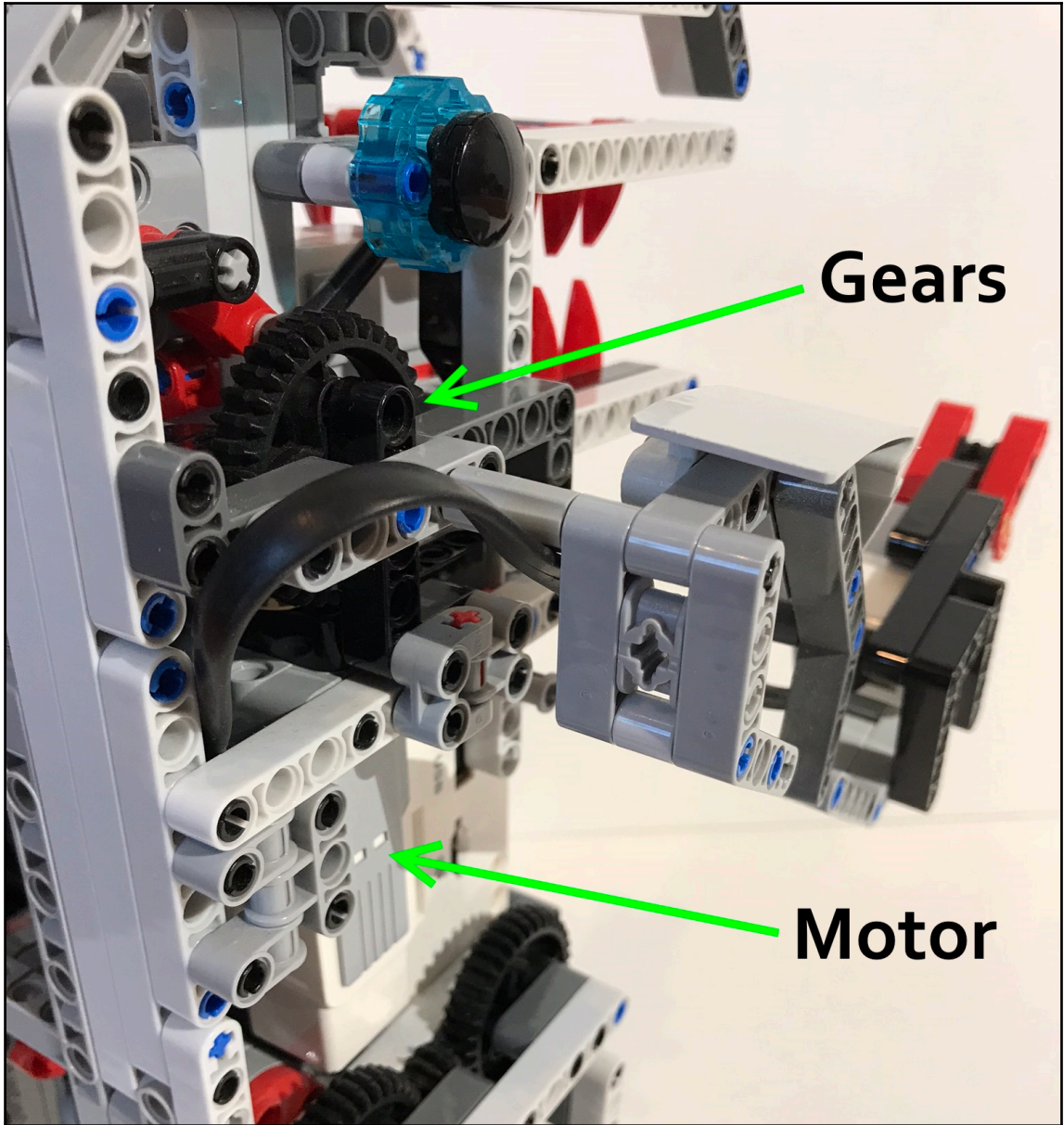

Gears

Motor

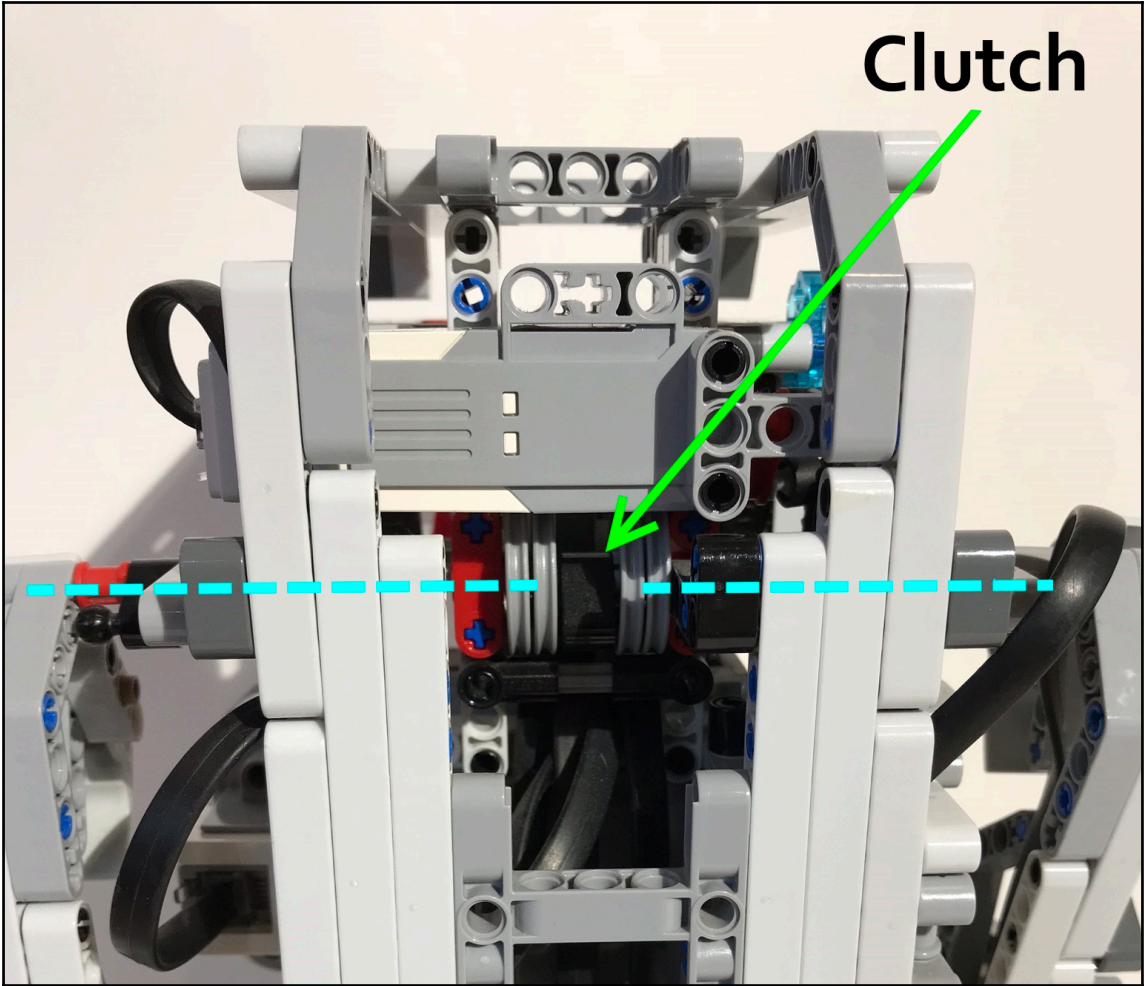

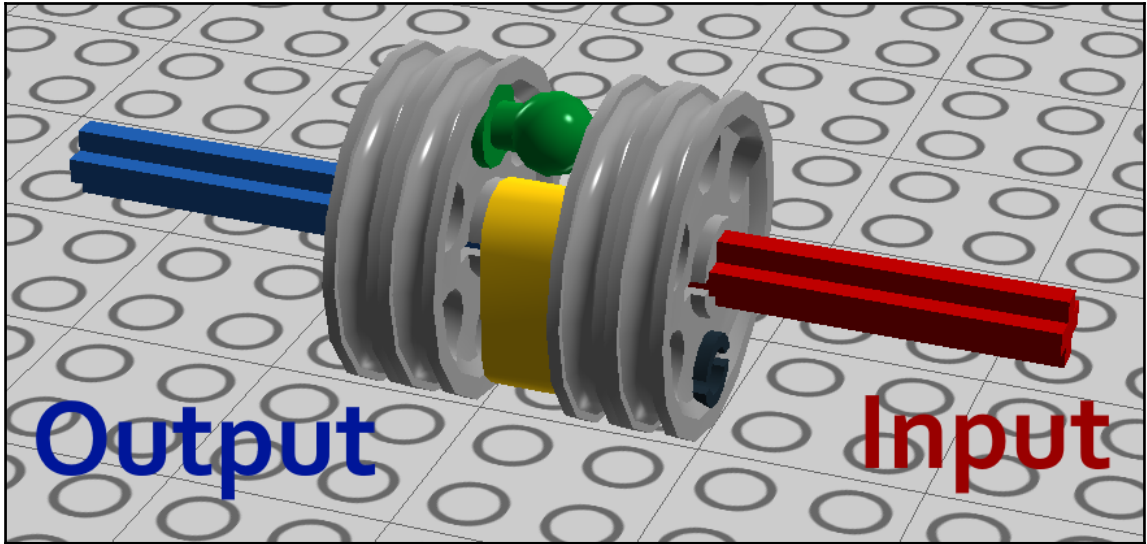



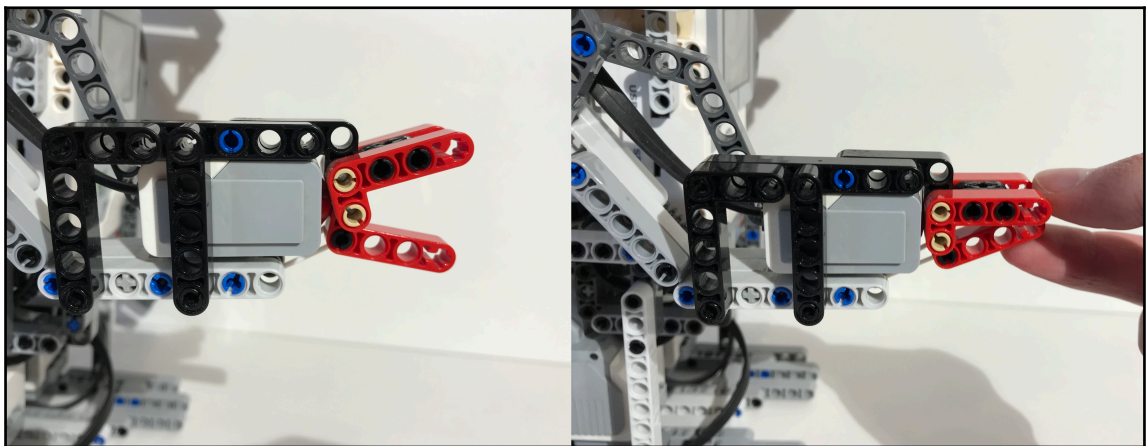
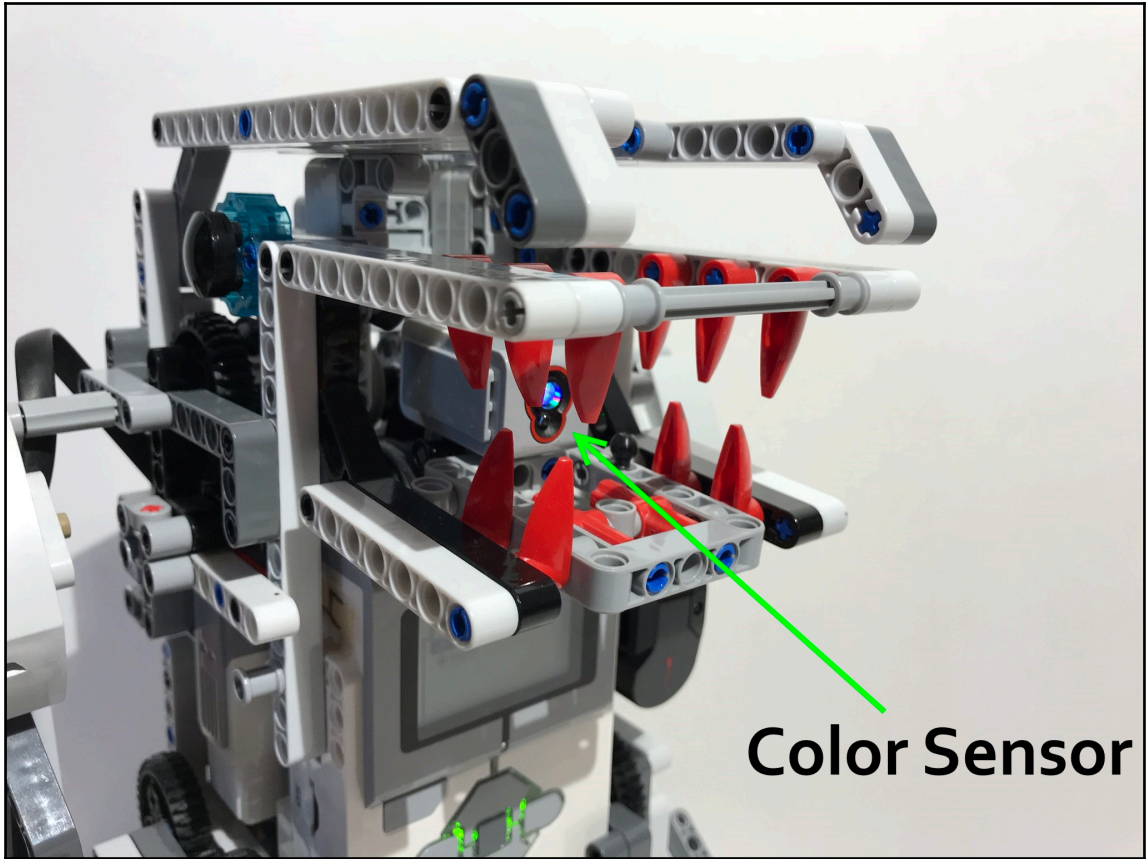

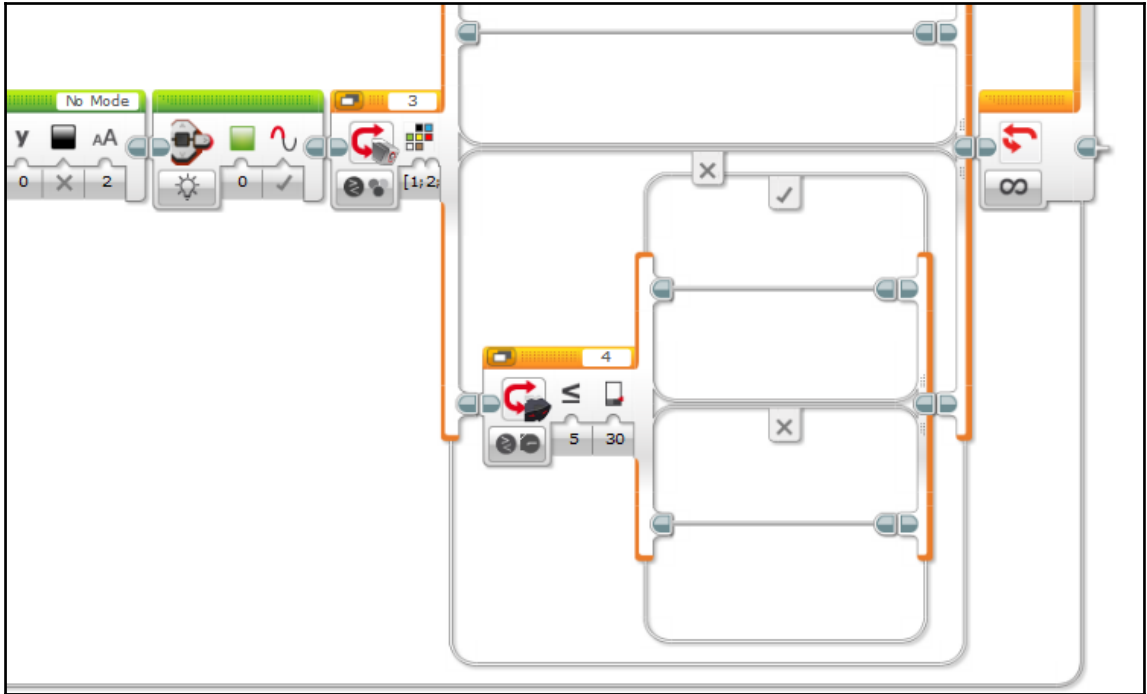

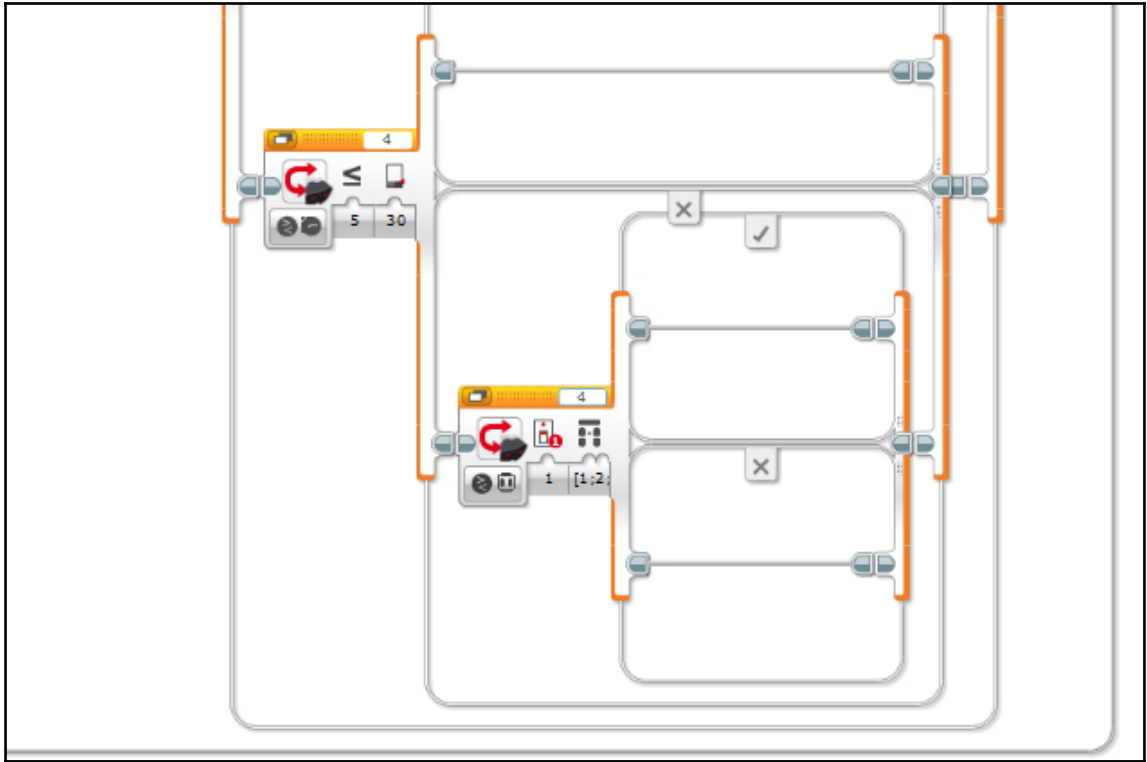

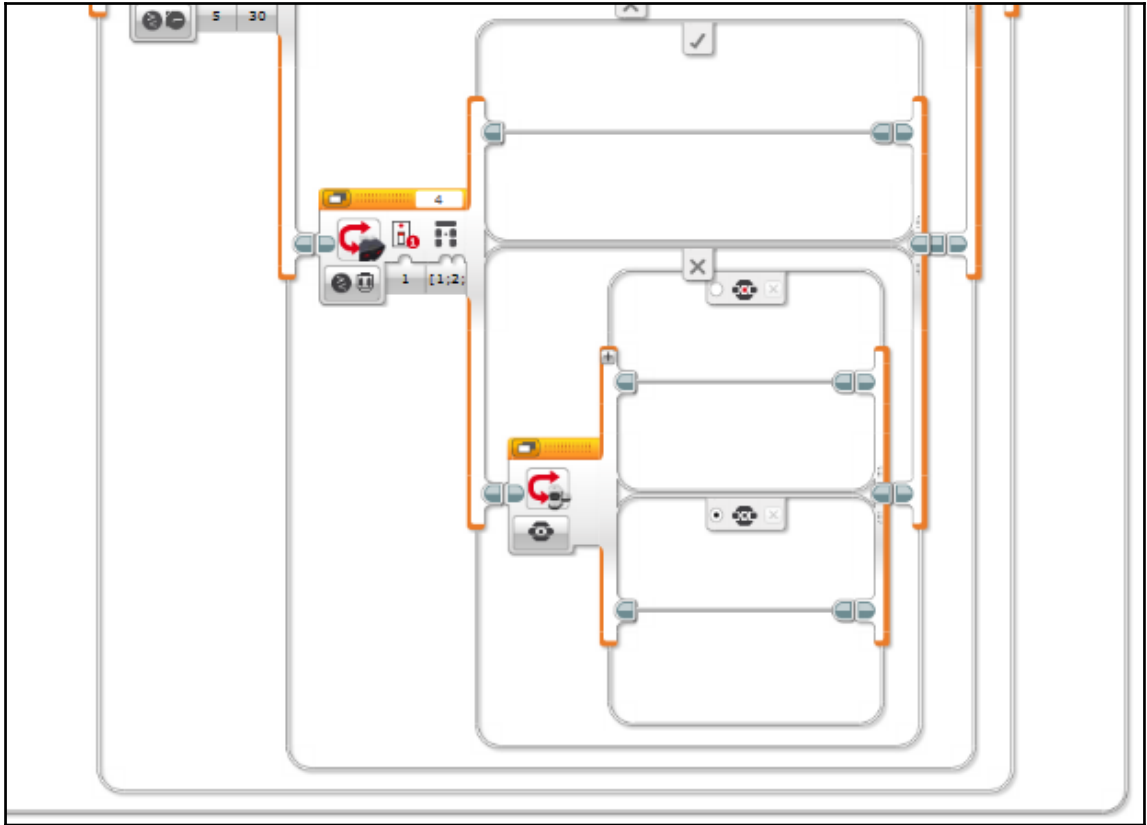

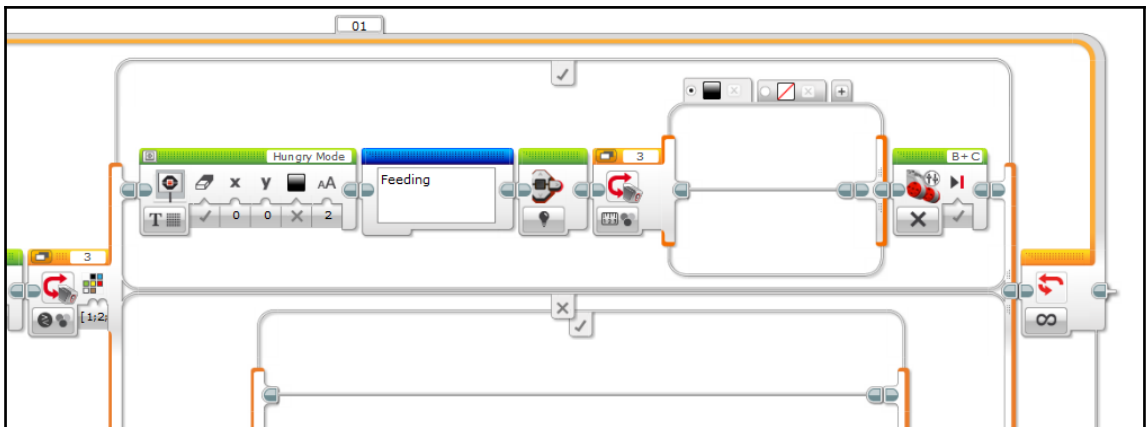
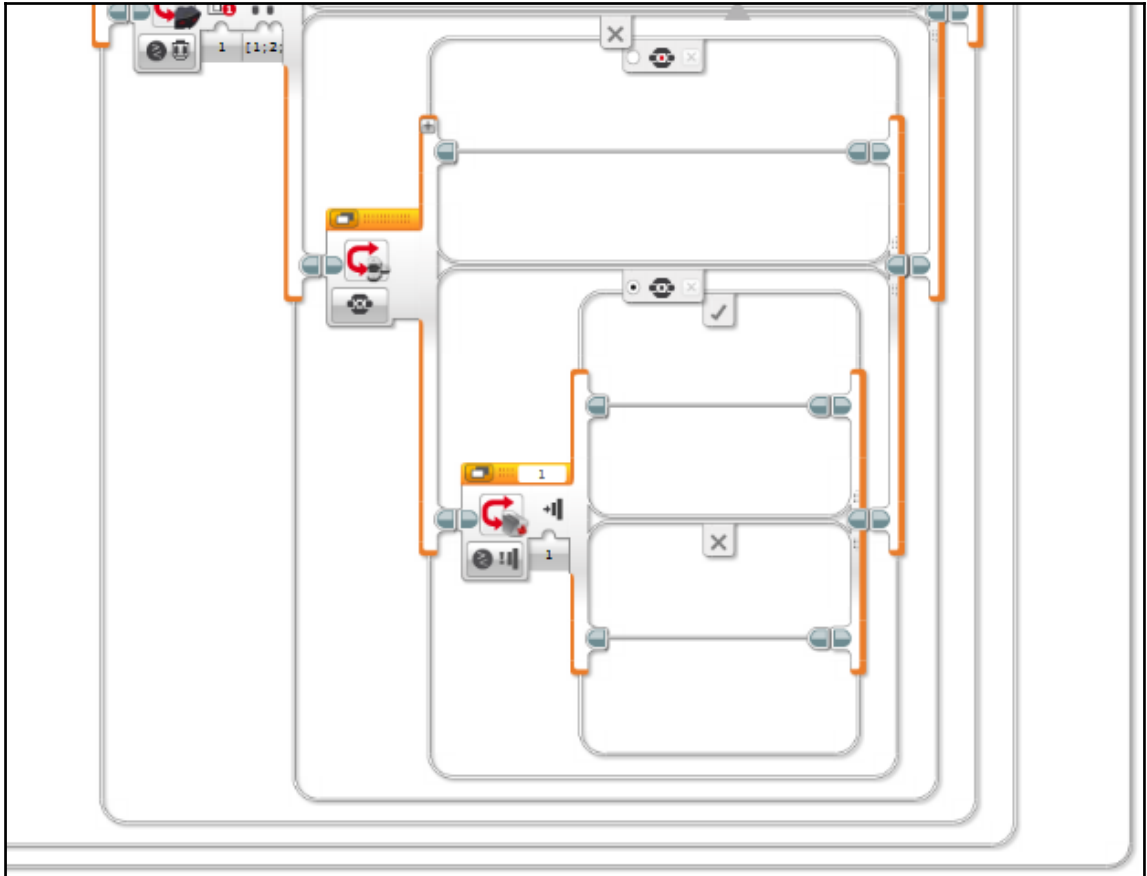

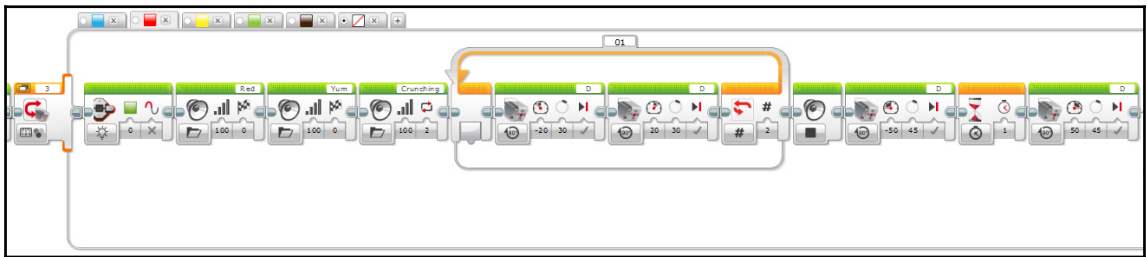
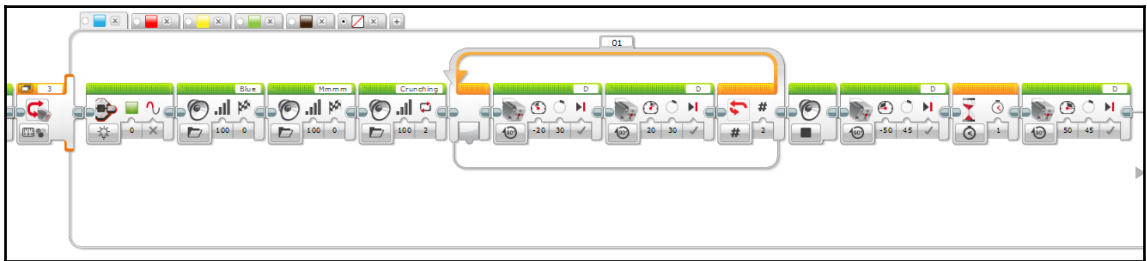

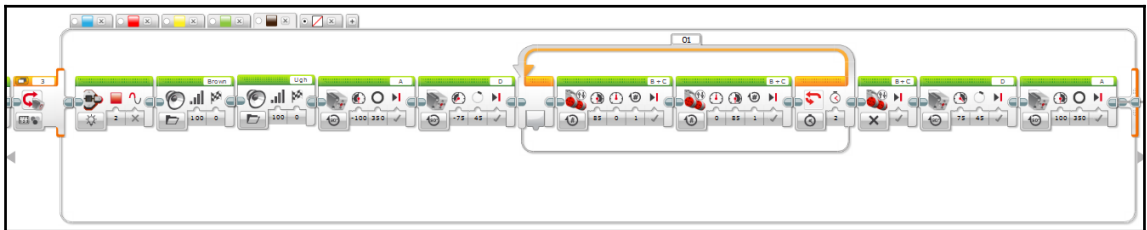
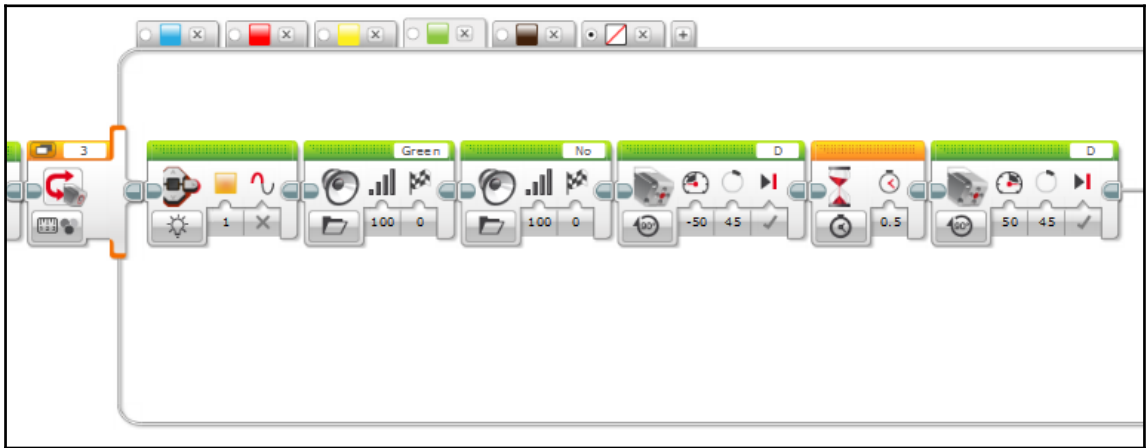
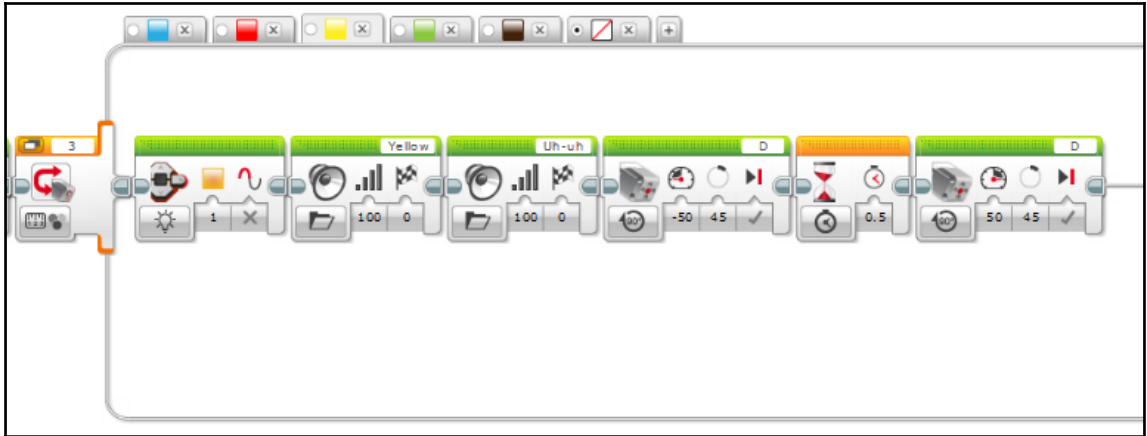

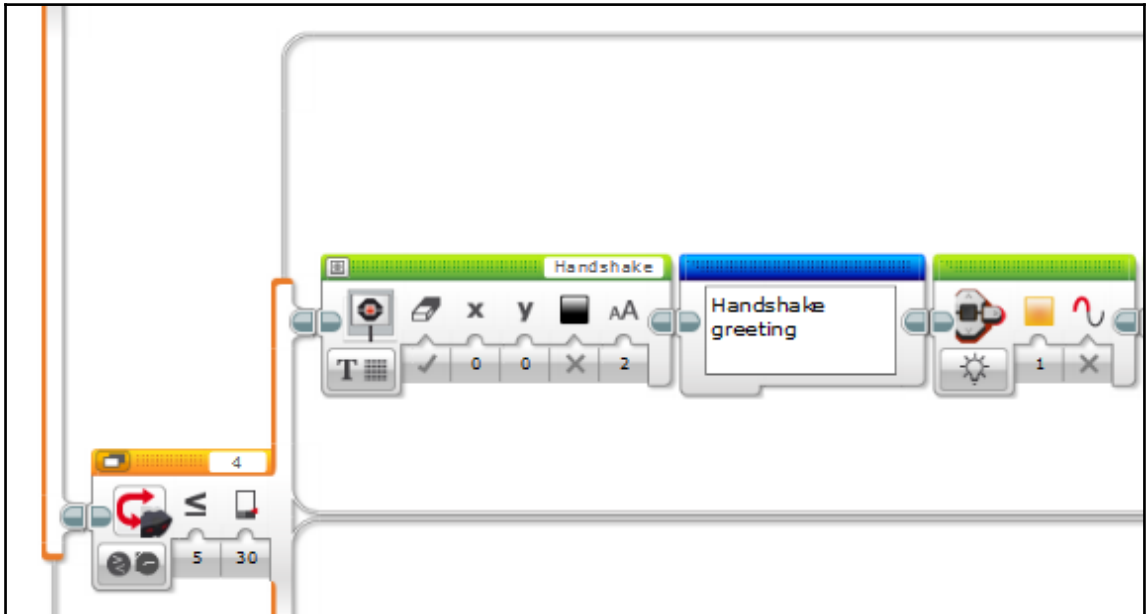

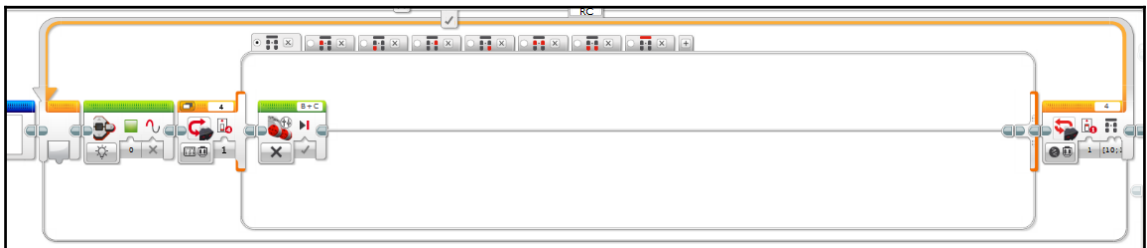
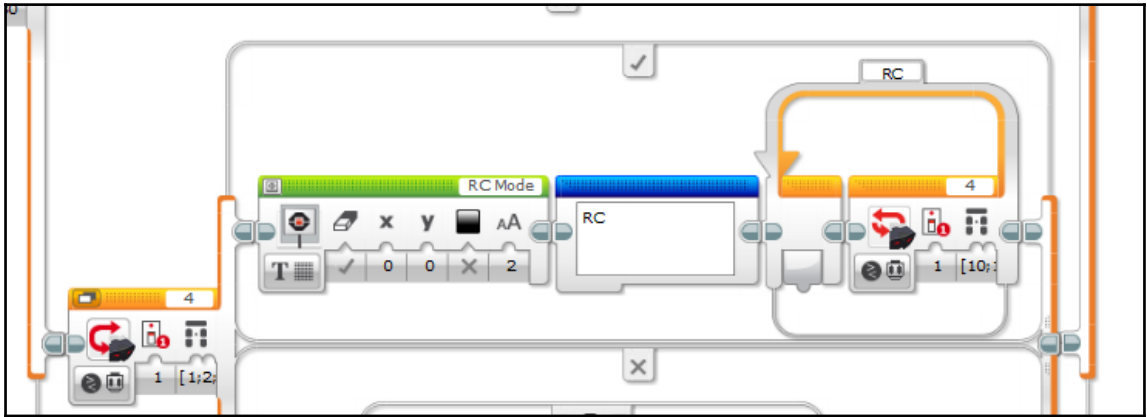
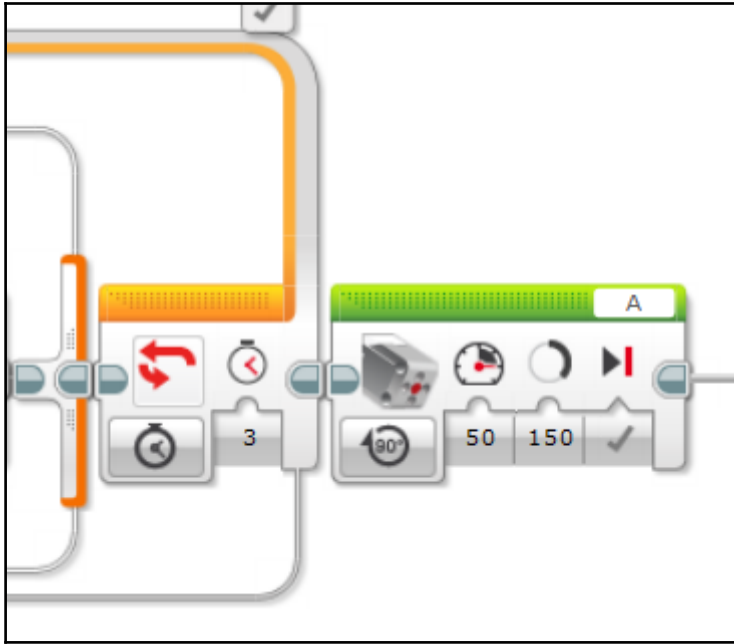

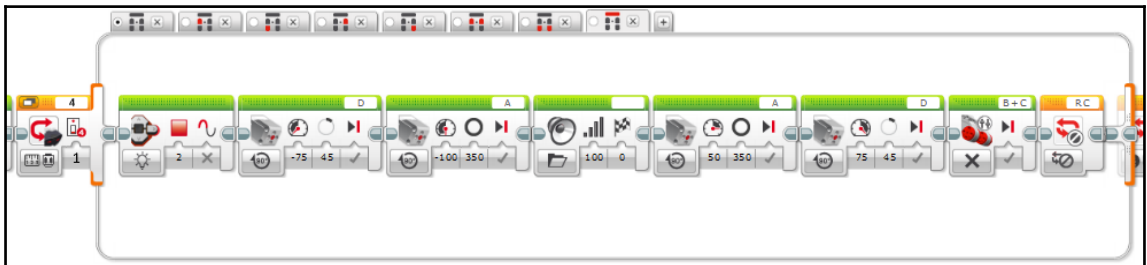
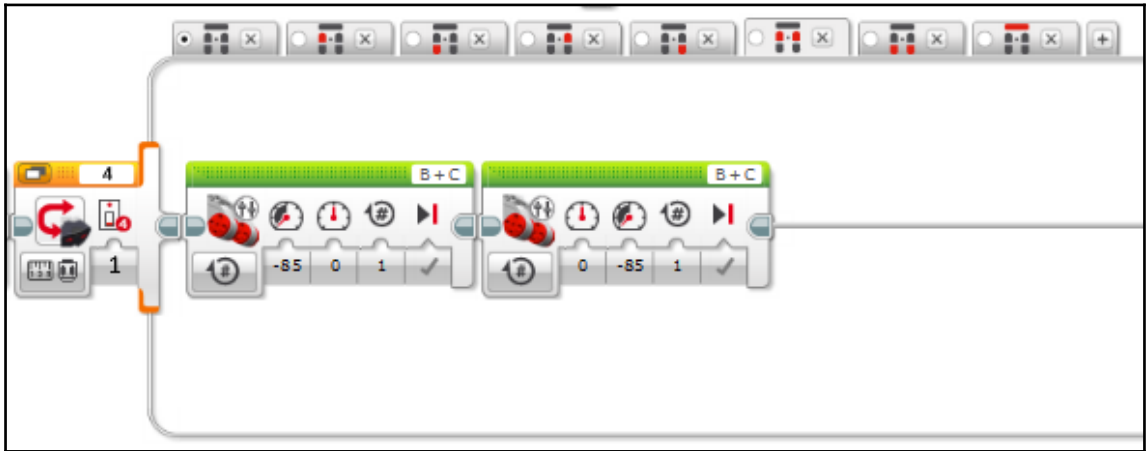
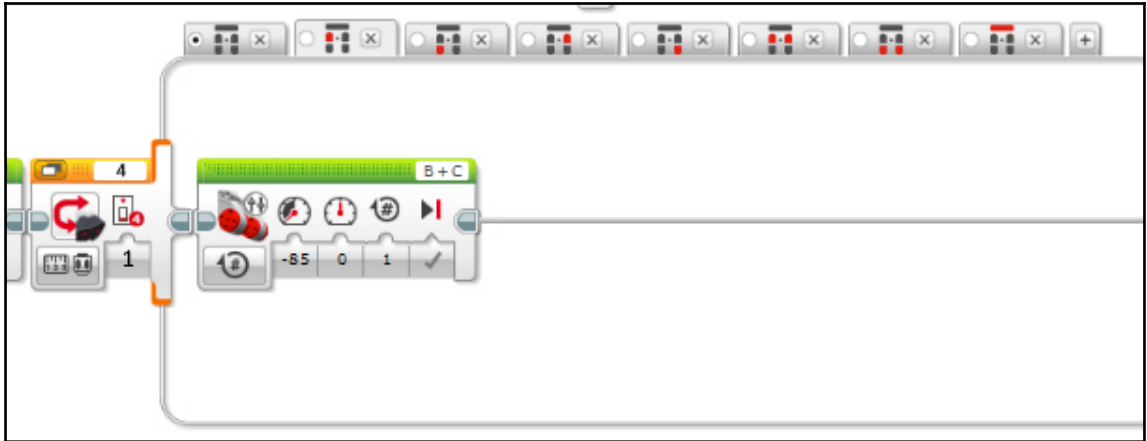

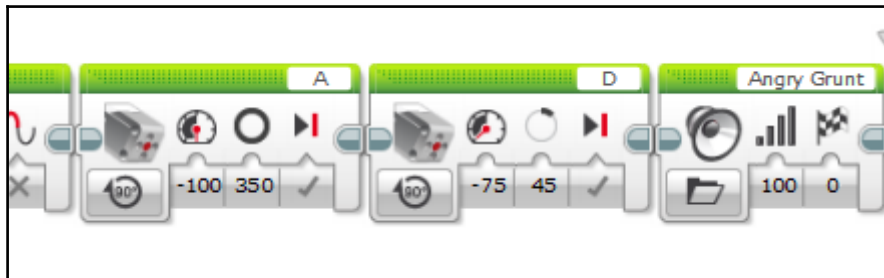

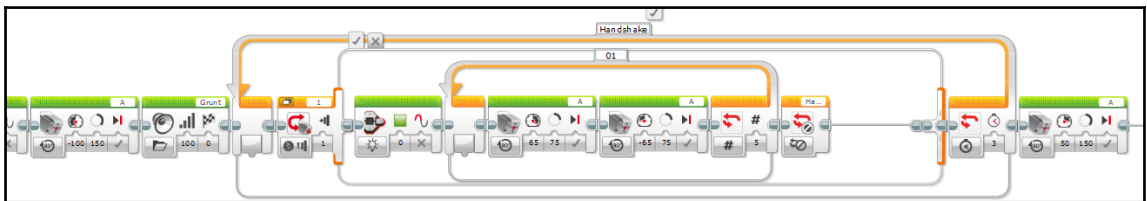
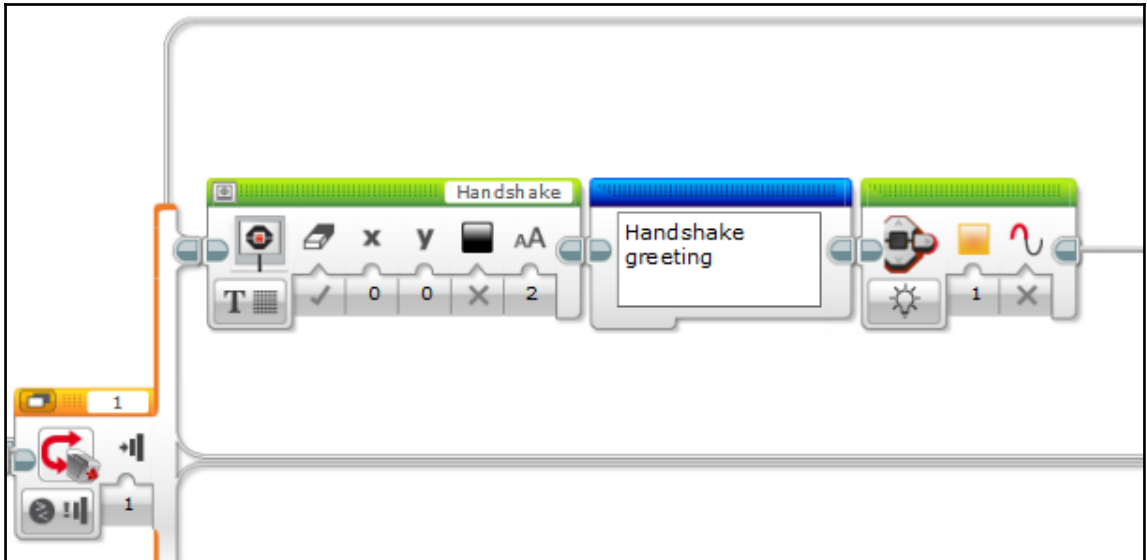
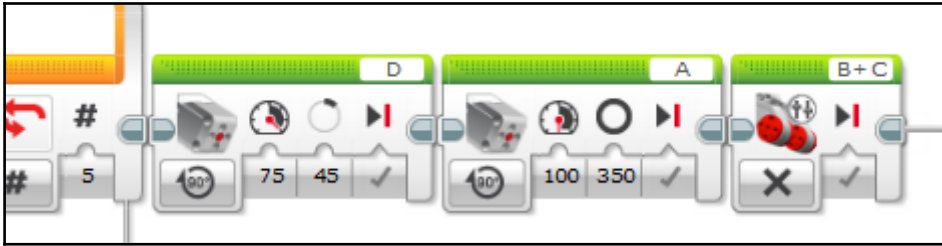

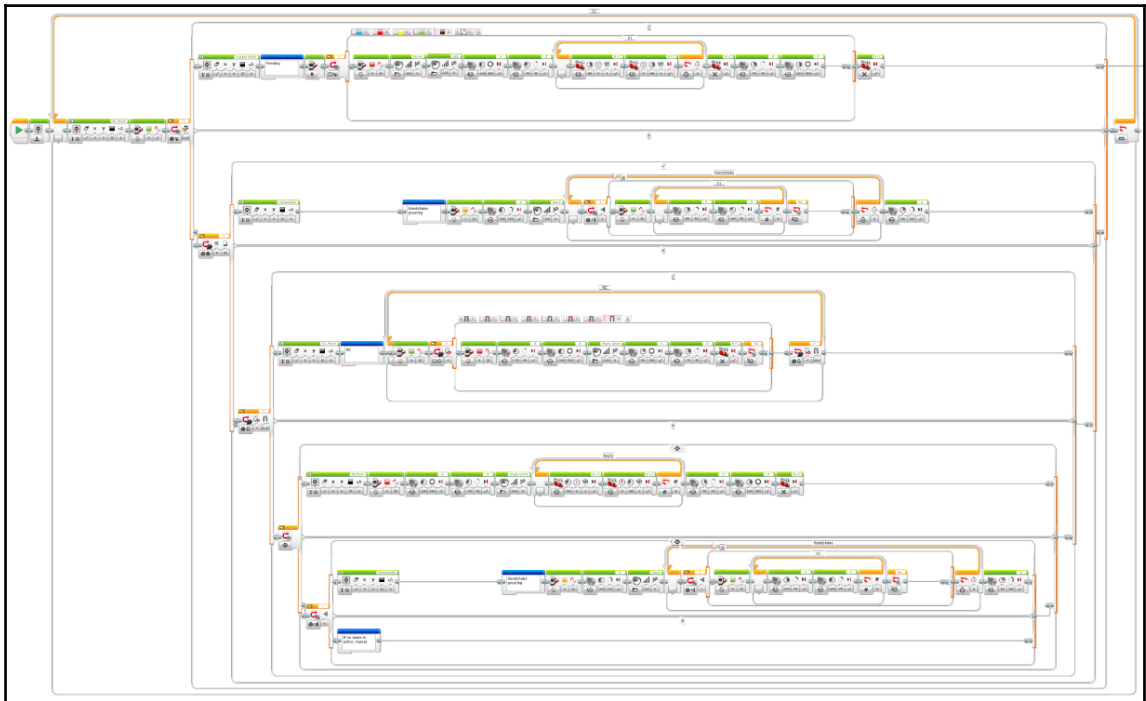
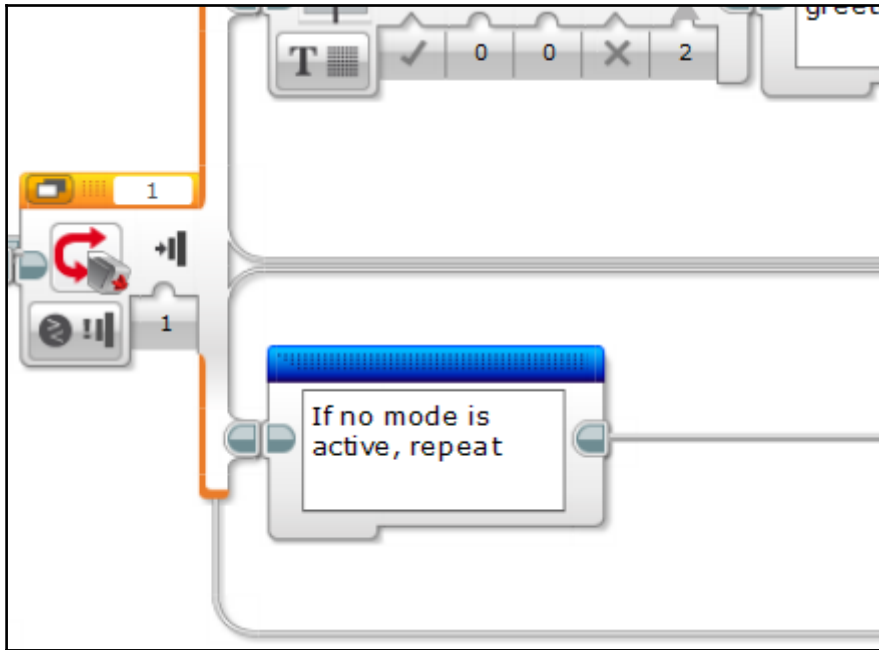

Chapter 06: Falcon – Remote Control Race Car



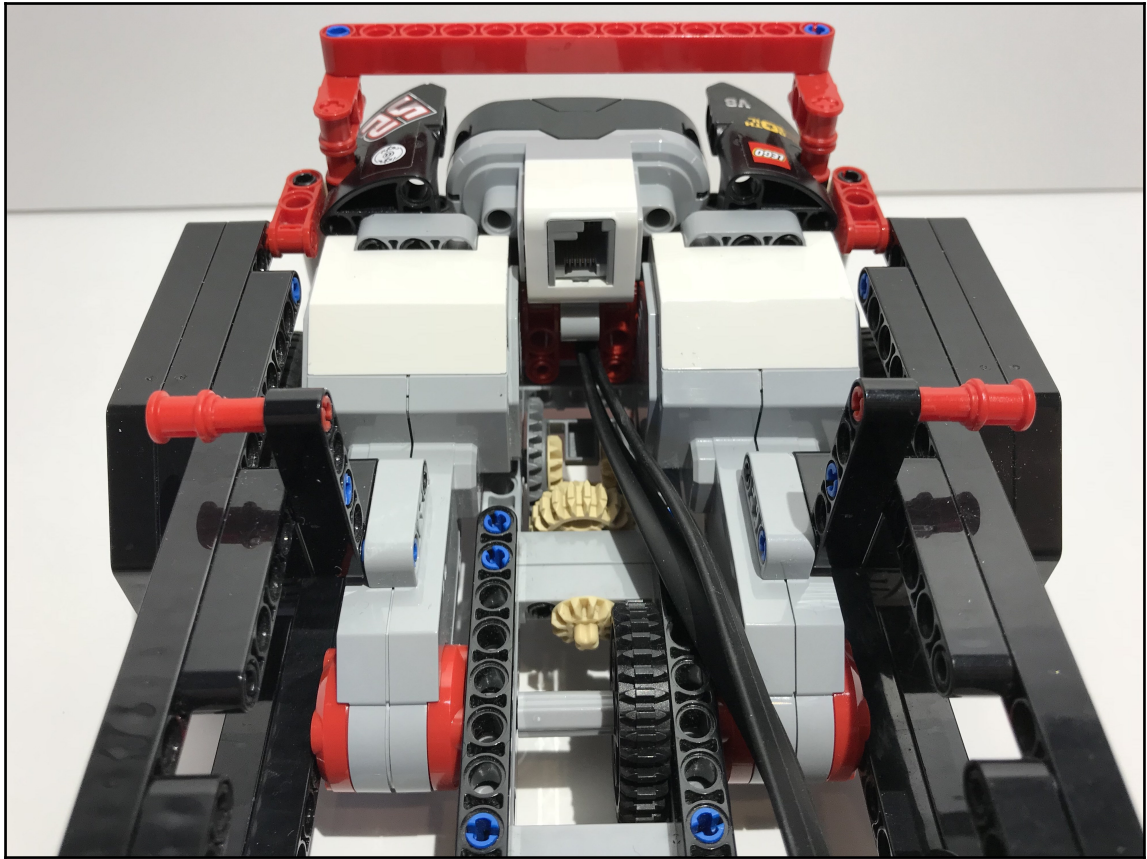

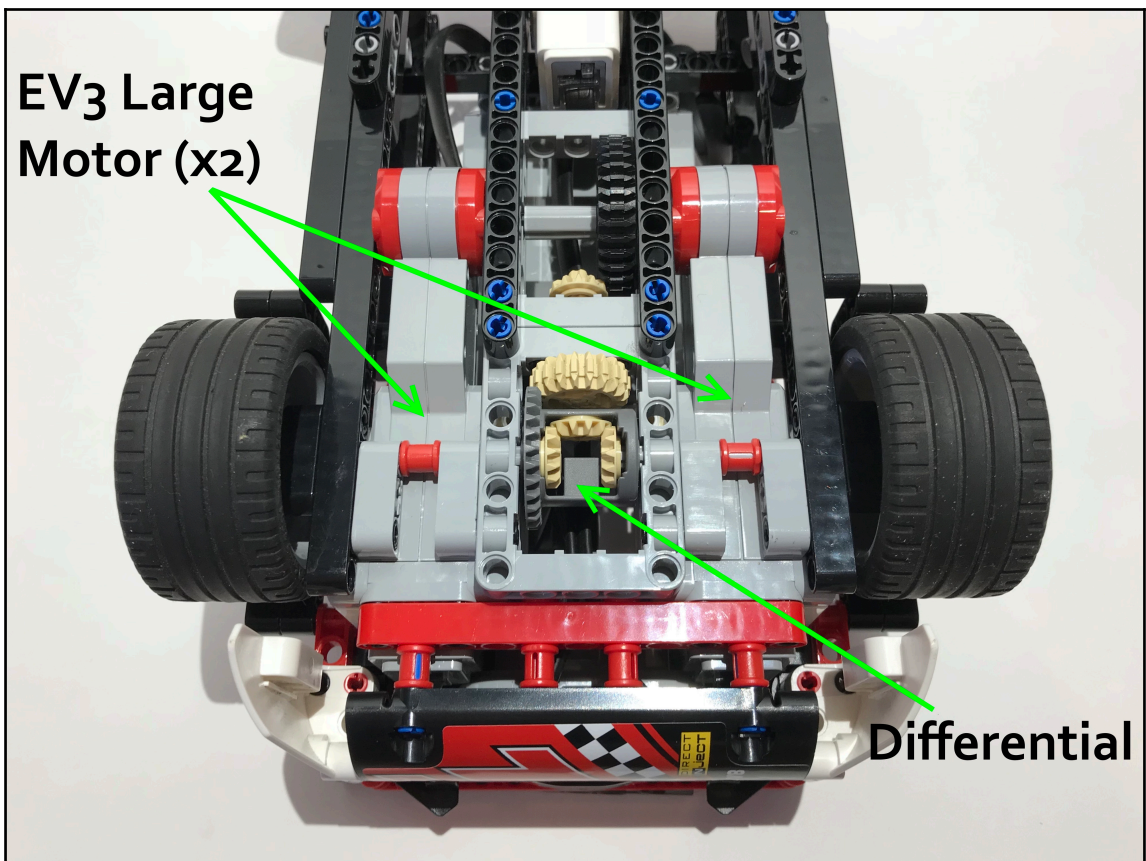

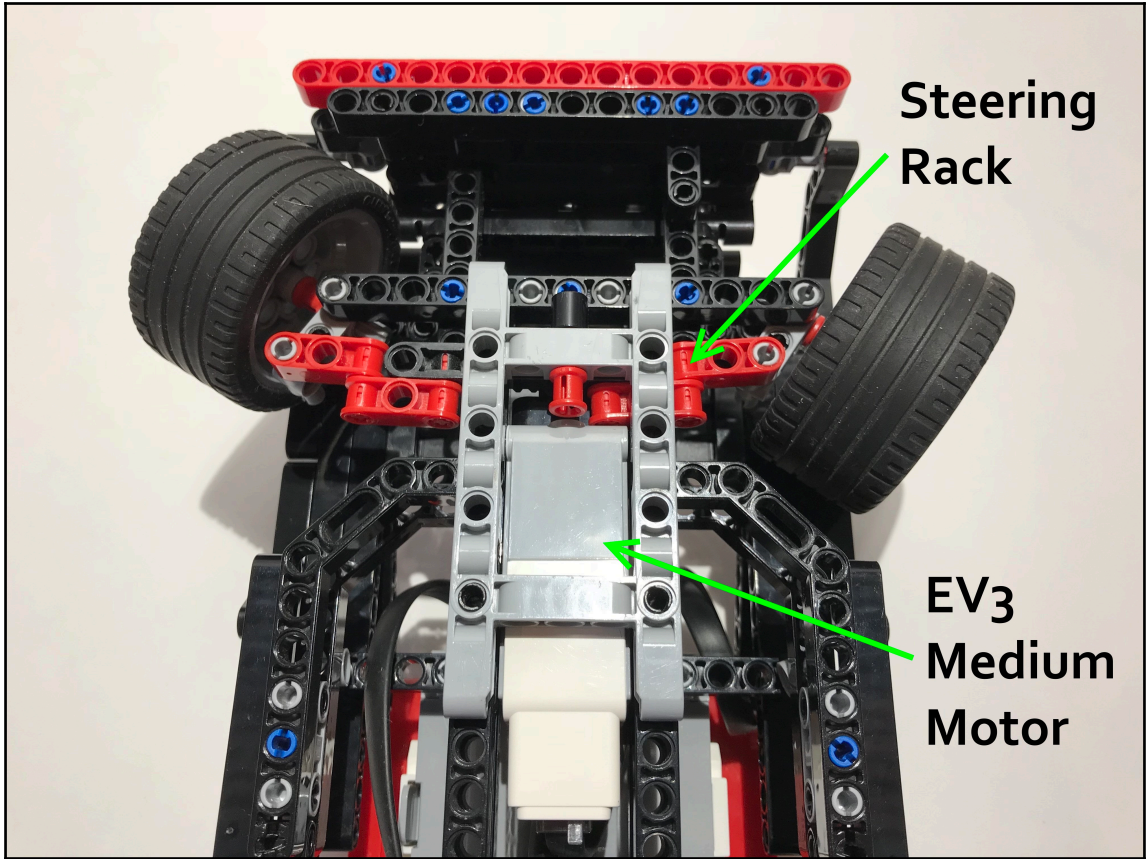

**Steering
Rack**

**EV3
Medium
Motor**

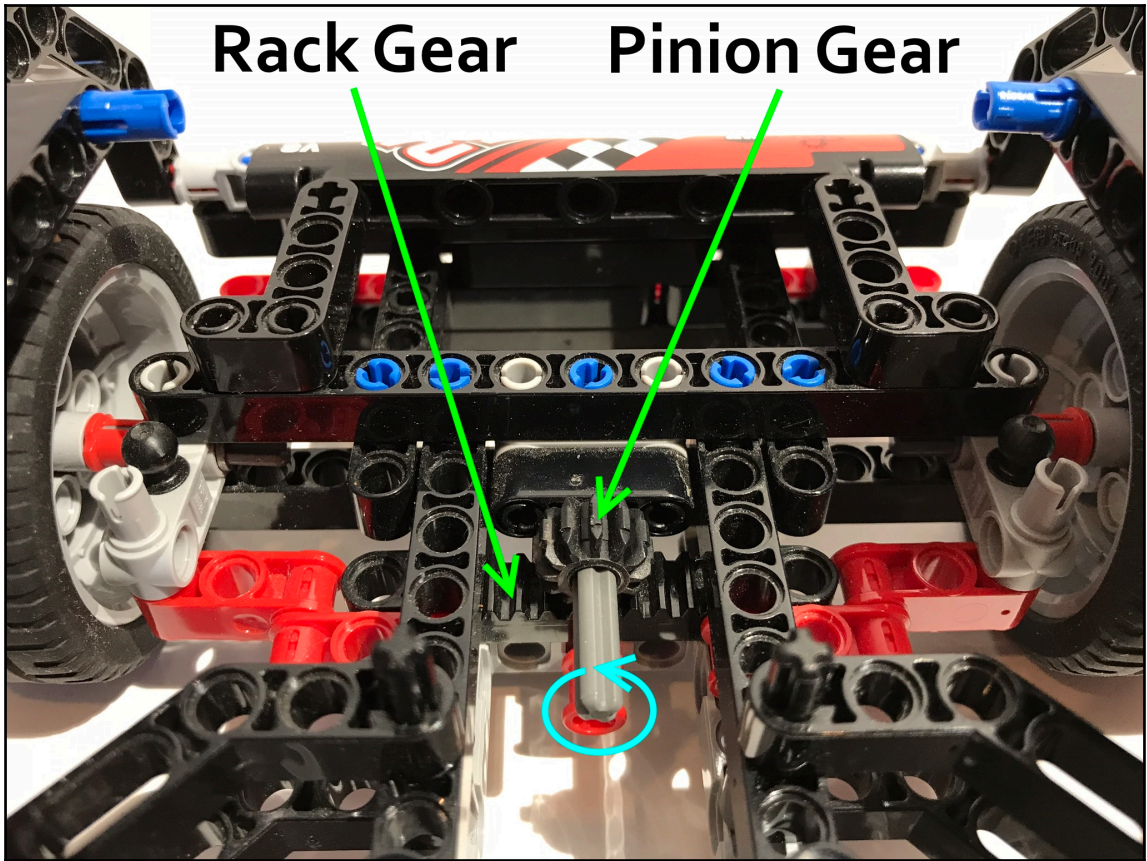

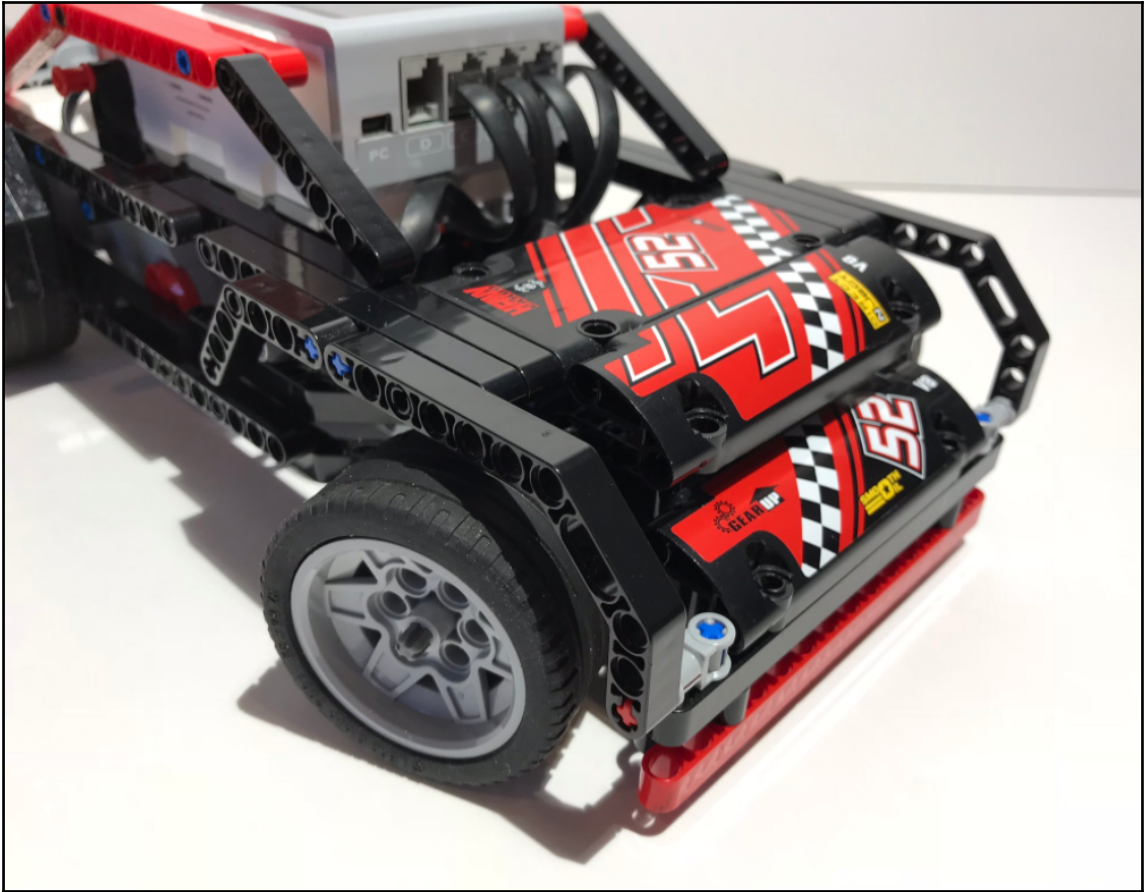



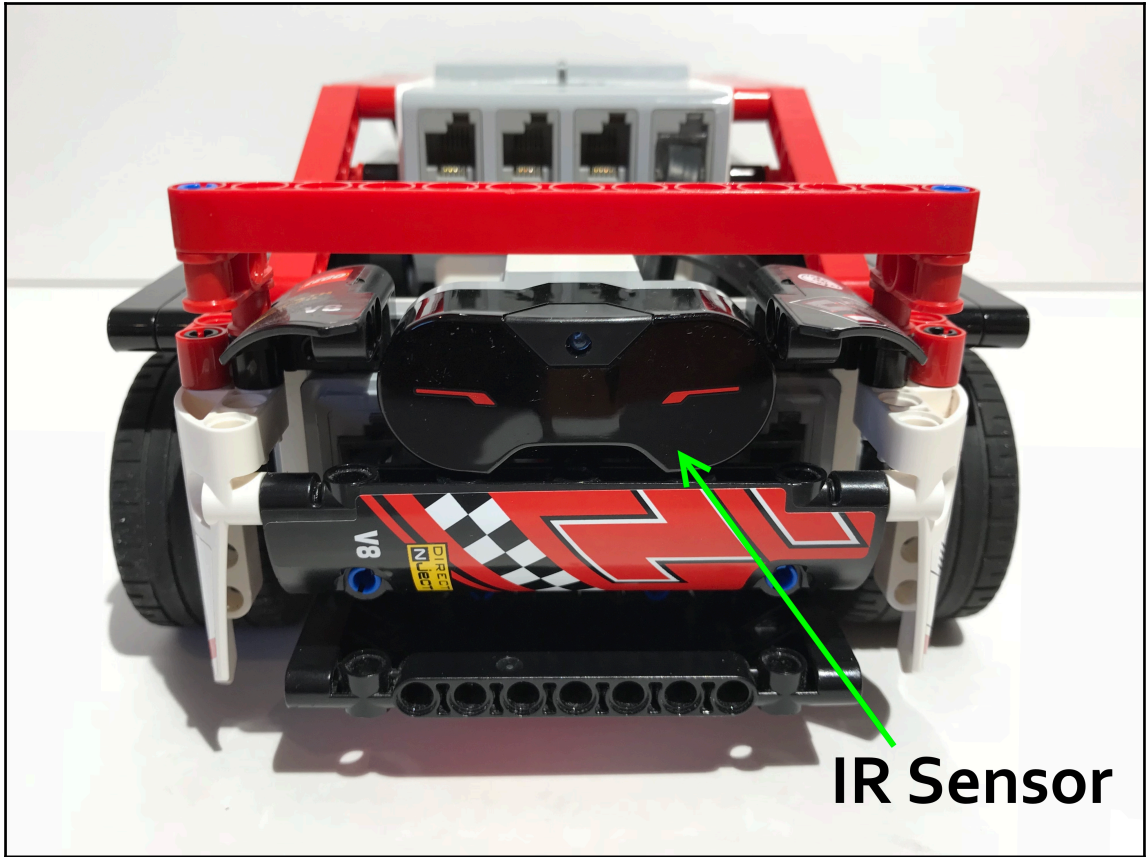

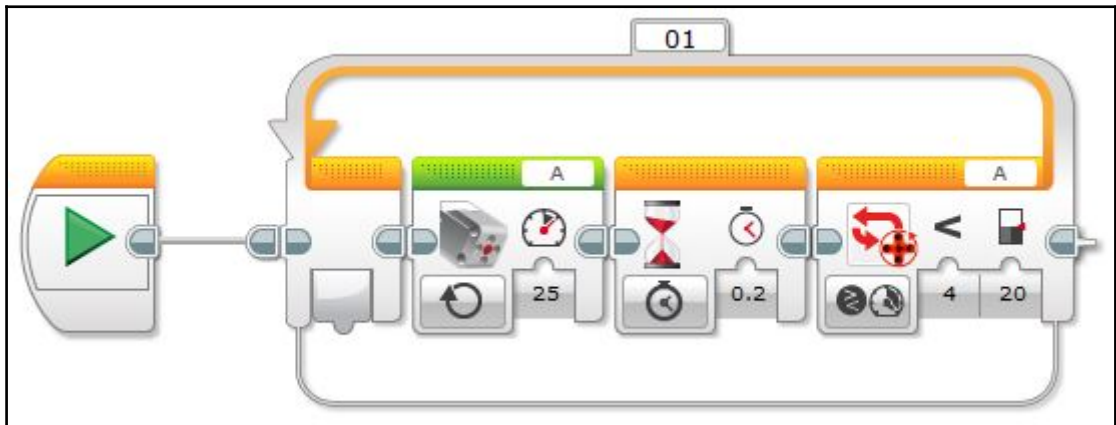
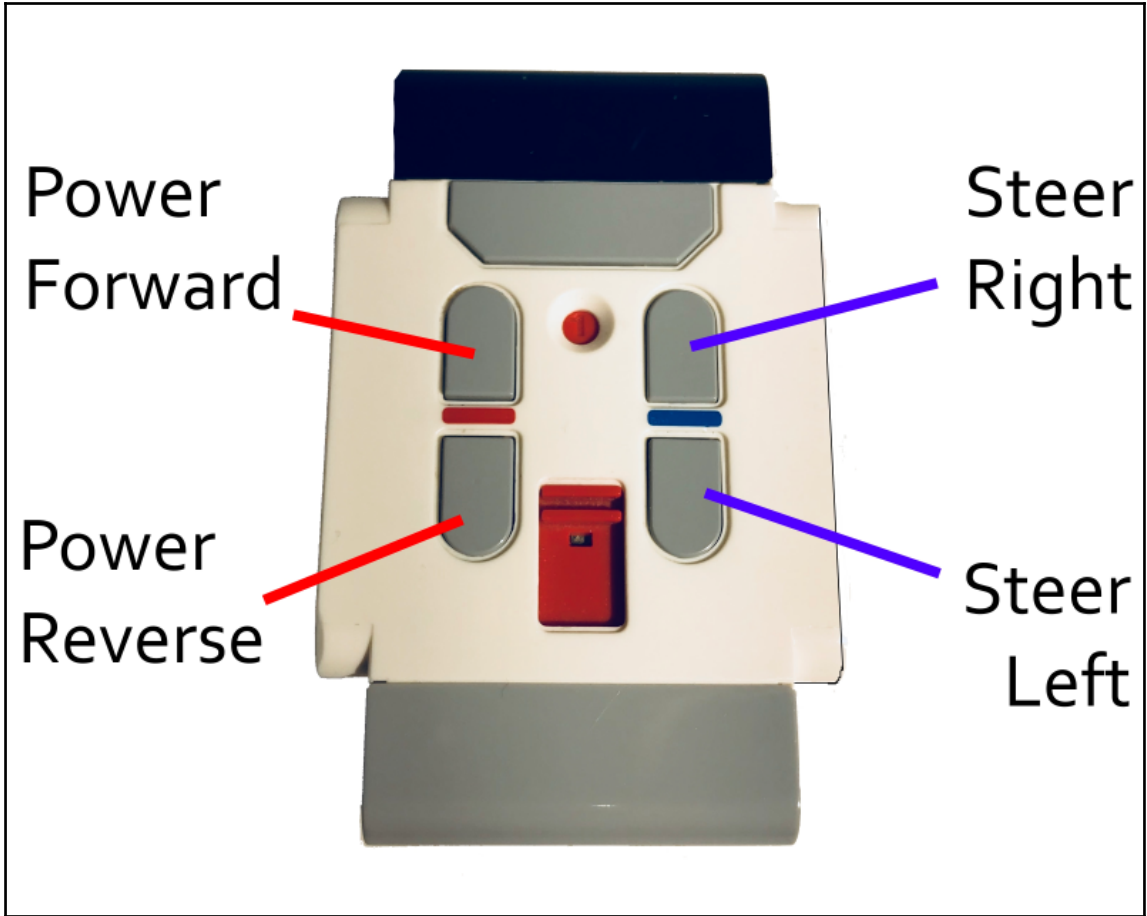

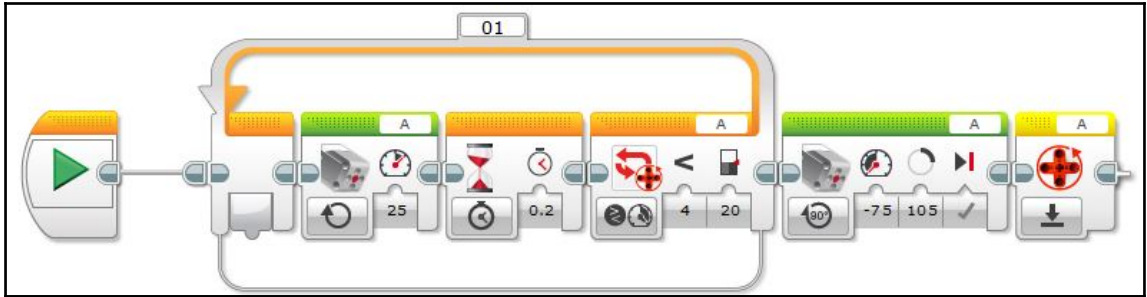

The 'My Block Builder' dialog box is shown. The 'Name' field contains 'steerCenter' and the 'Description' field contains 'Centers steering at the start of the program'. Below these fields is a 'My Block Icons' grid with various icons. At the bottom right of the dialog are 'Finish' and 'Cancel' buttons.

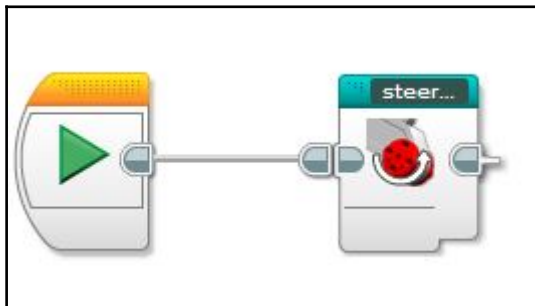

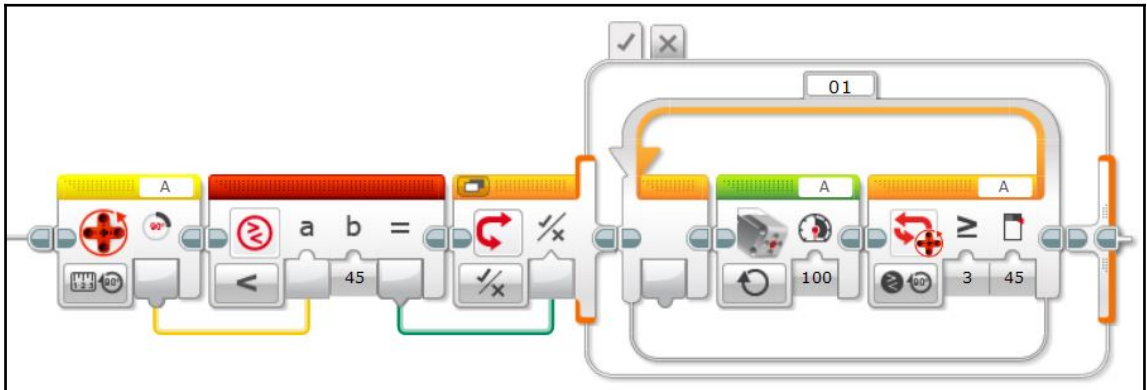
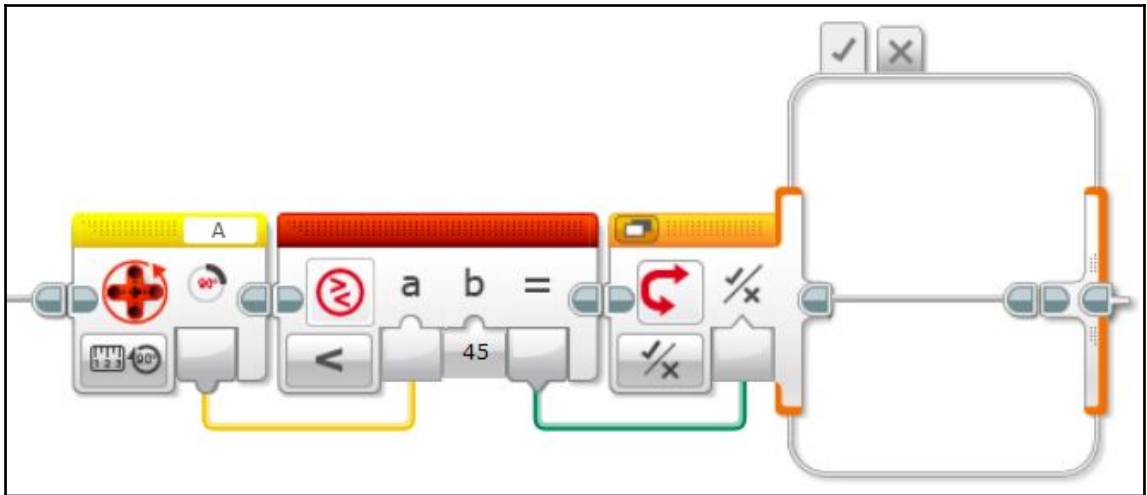
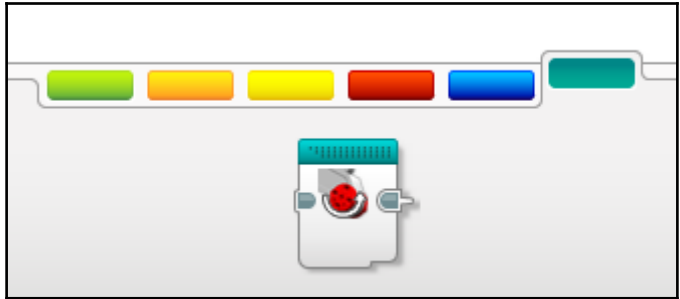

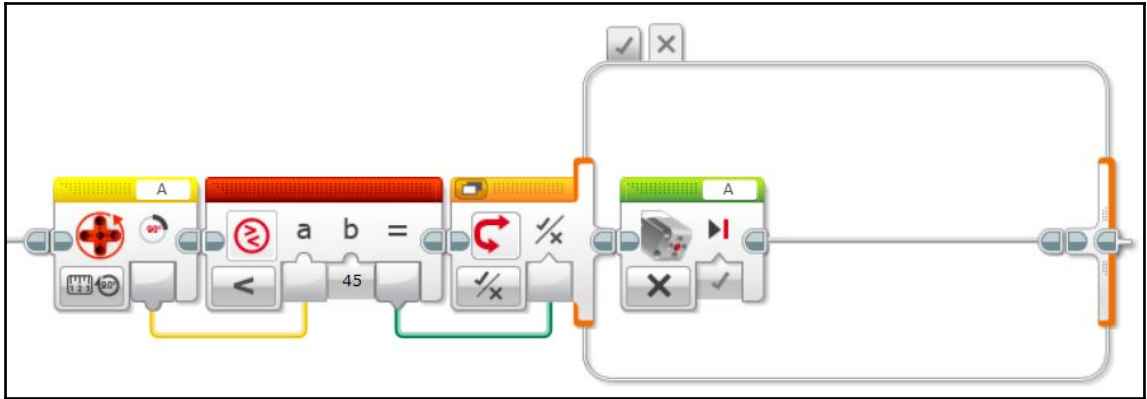

The screenshot shows the **My Block Builder** dialog box with the following details:

- Name:**
- Description:**
- My Block Icons:** A grid of 48 icons for selecting a block icon. The icons include various Scratch symbols like a head, a gear, a motor, a wheel, a lightbulb, a speech bubble, a document, a mail icon, a Bluetooth symbol, and a no symbol.
- Buttons:** and

The dialog box is overlaid on a Scratch script, with a blue line connecting the 'steerLeft' block in the script to the dialog box.

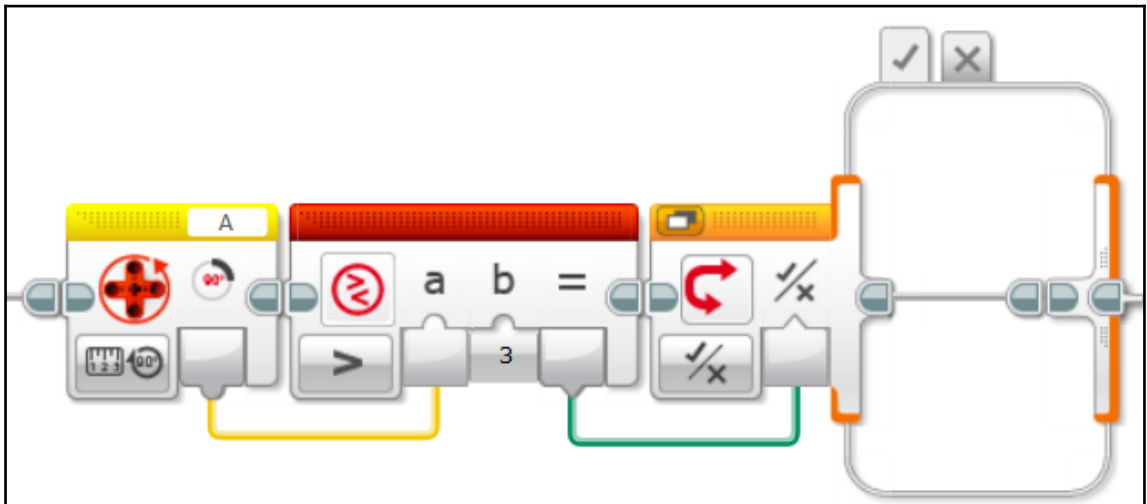
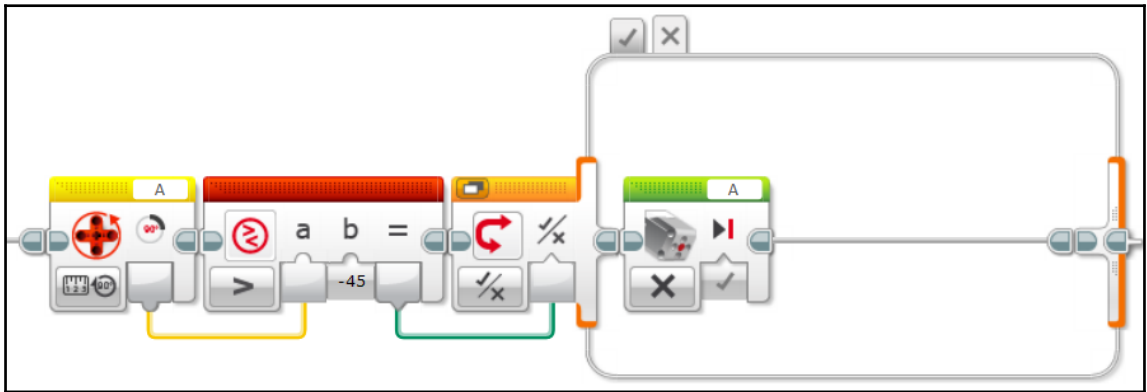
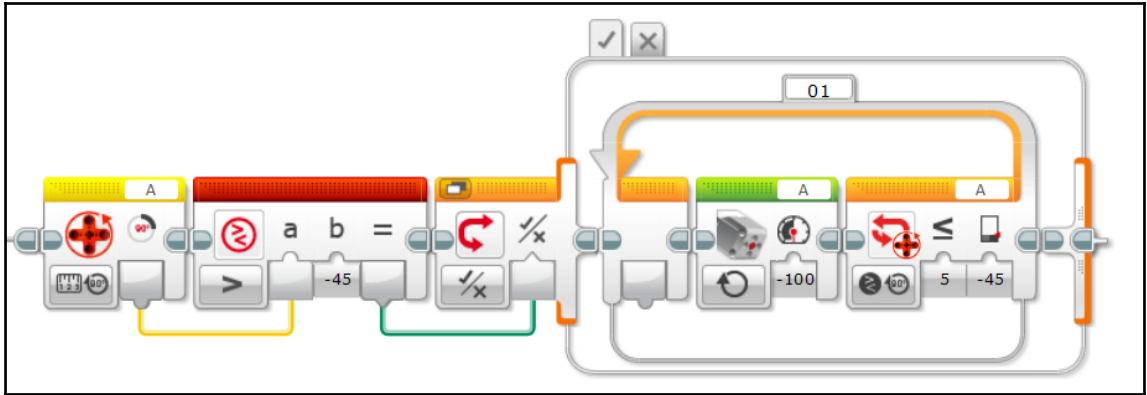

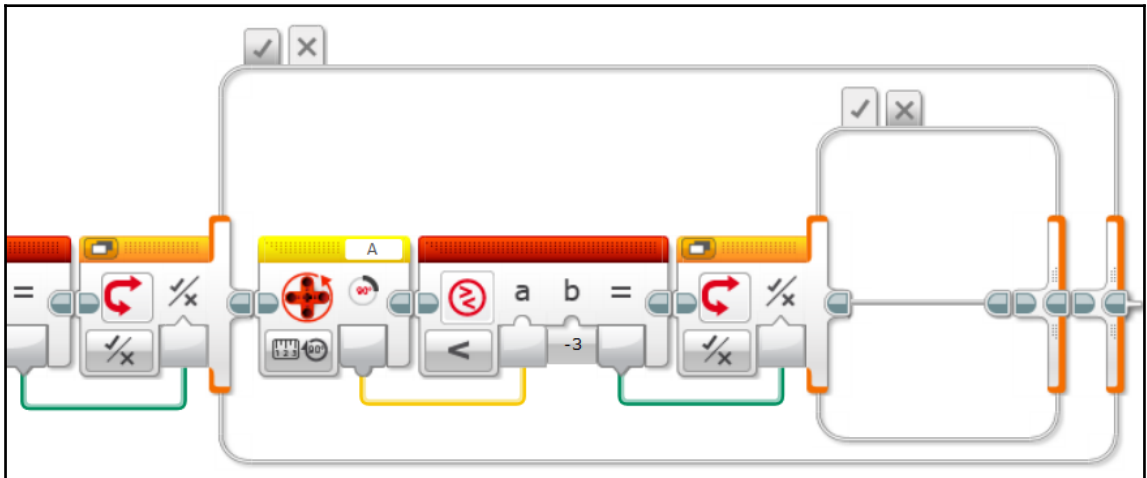
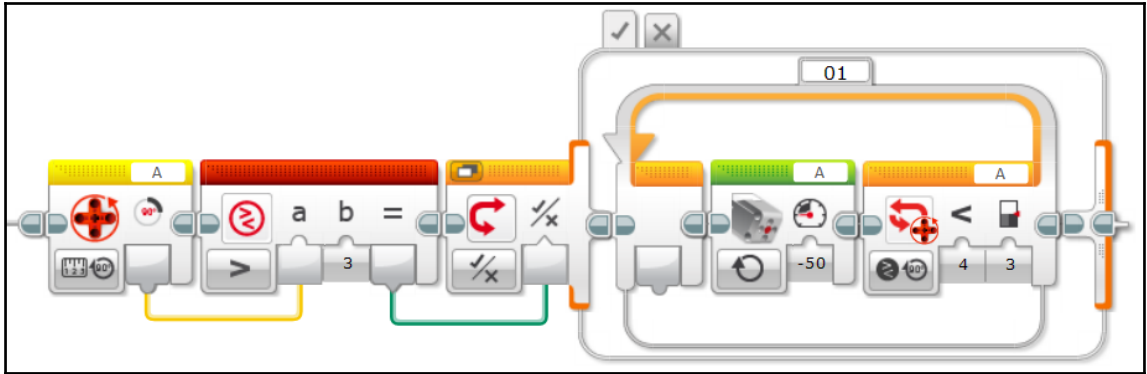

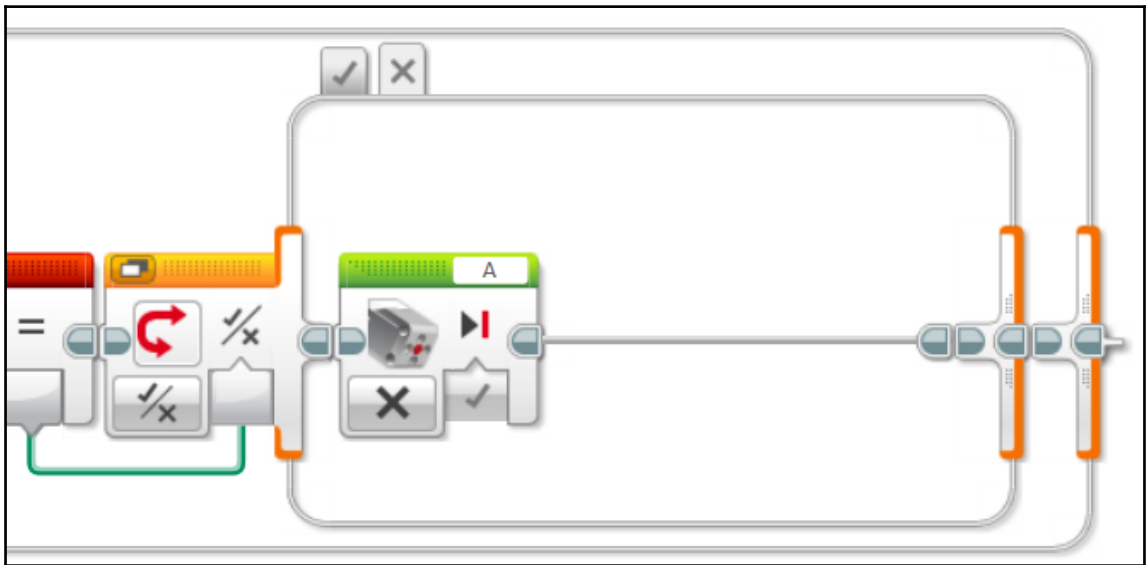
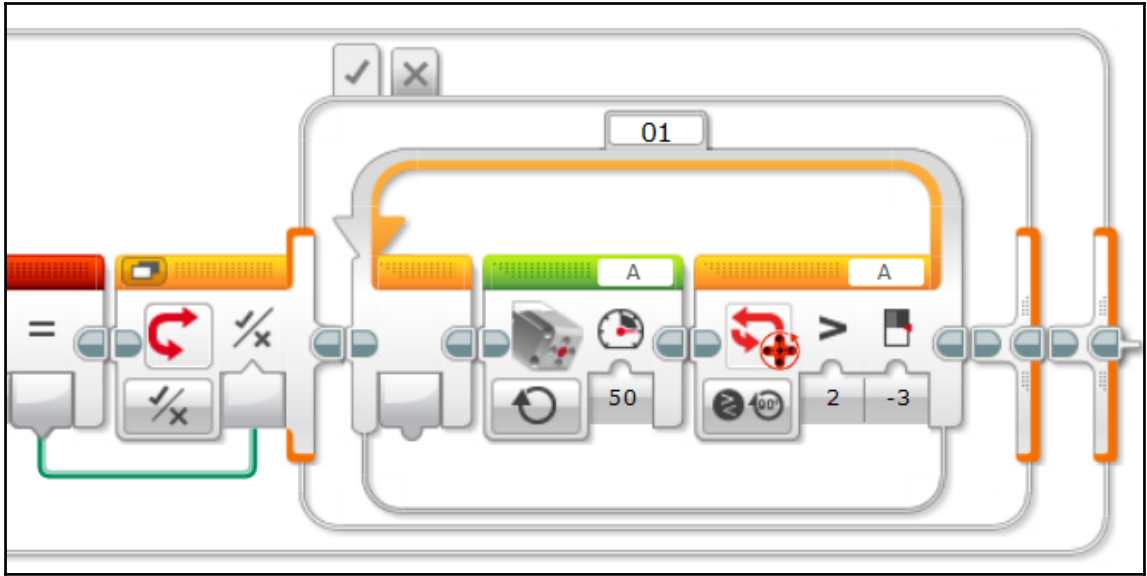

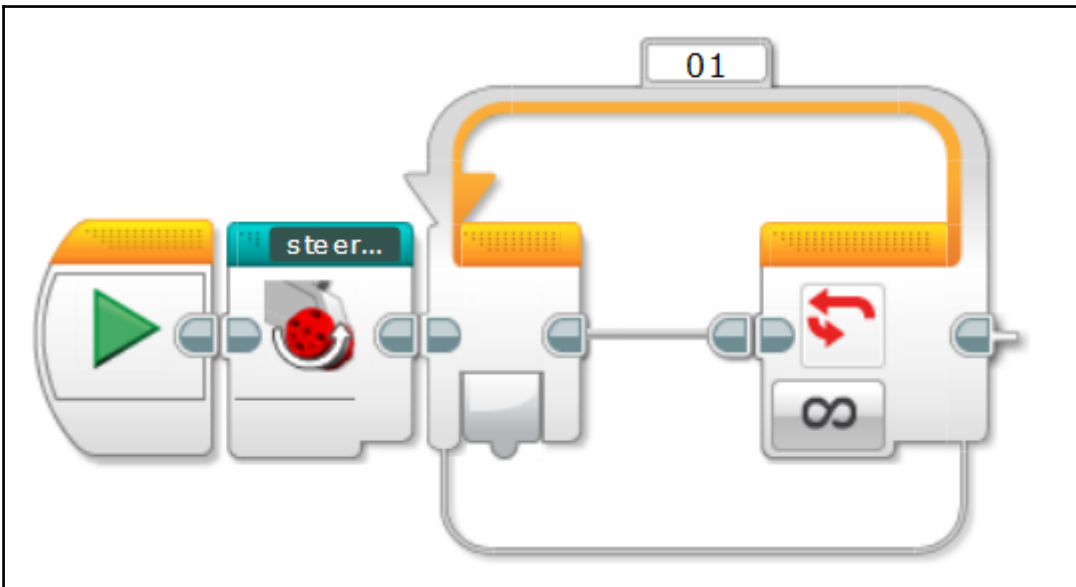
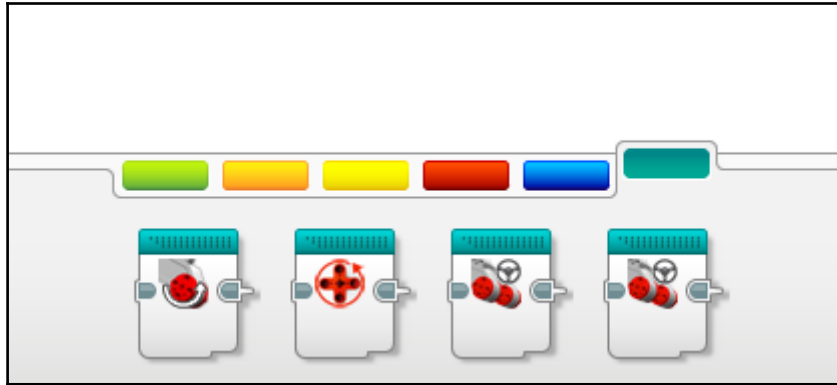

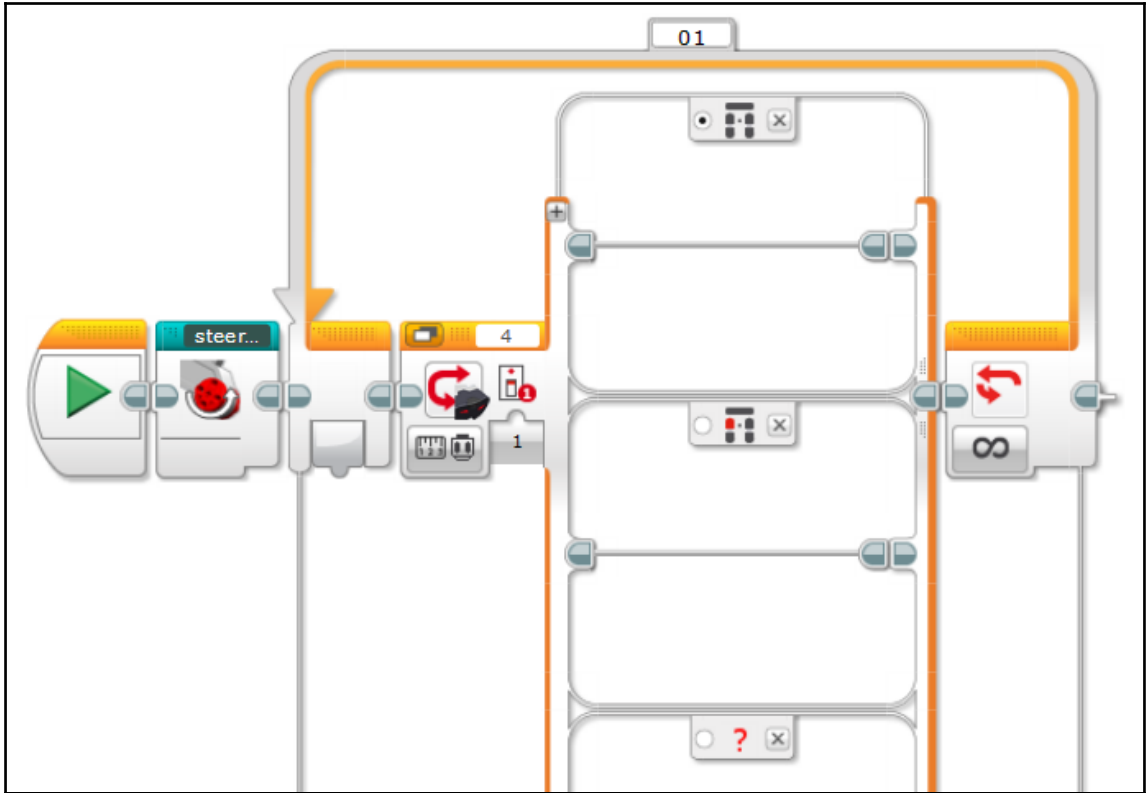

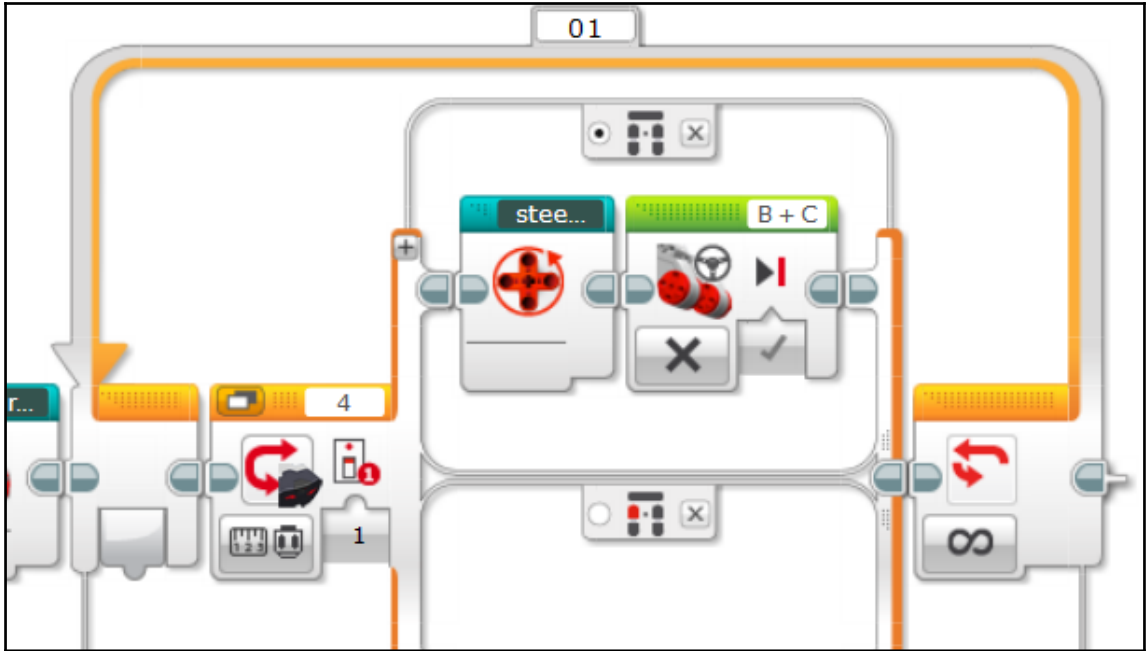

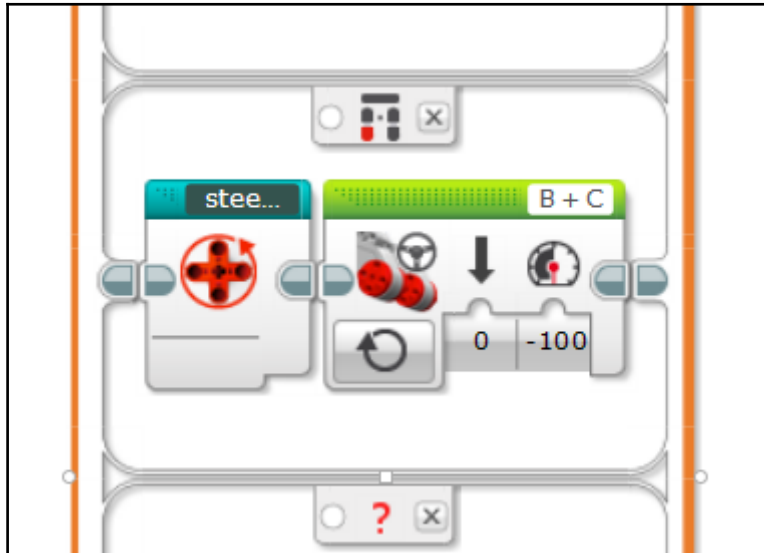
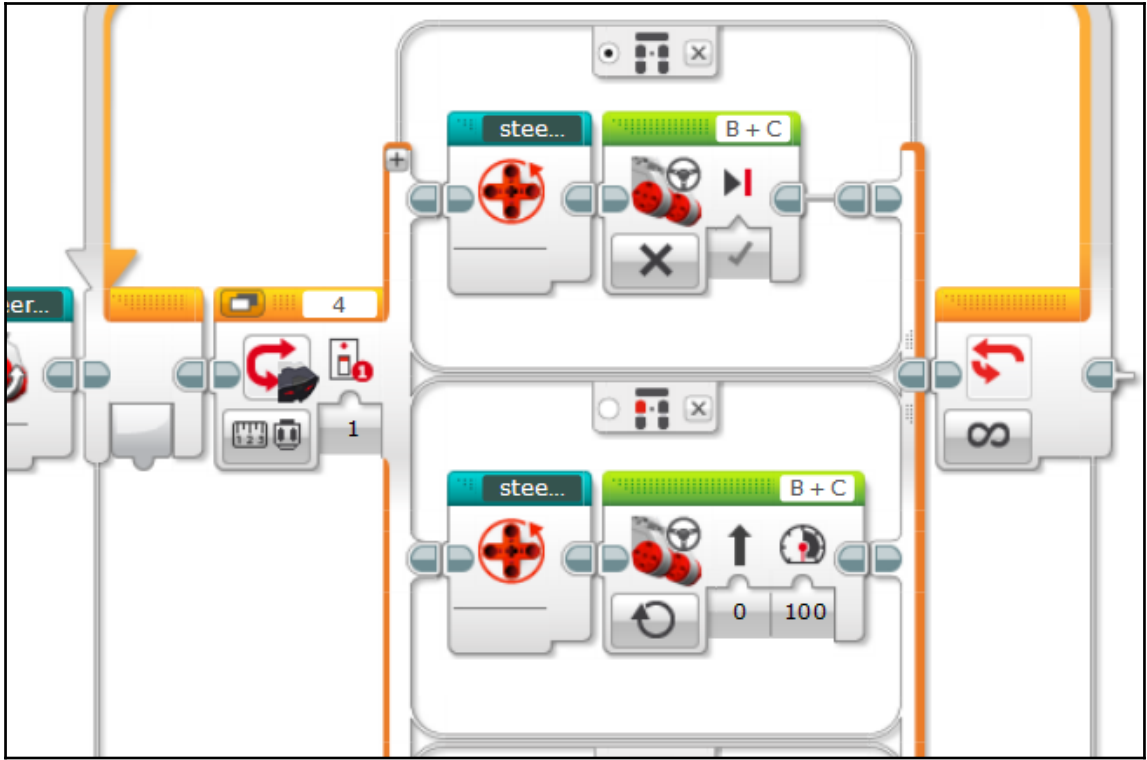

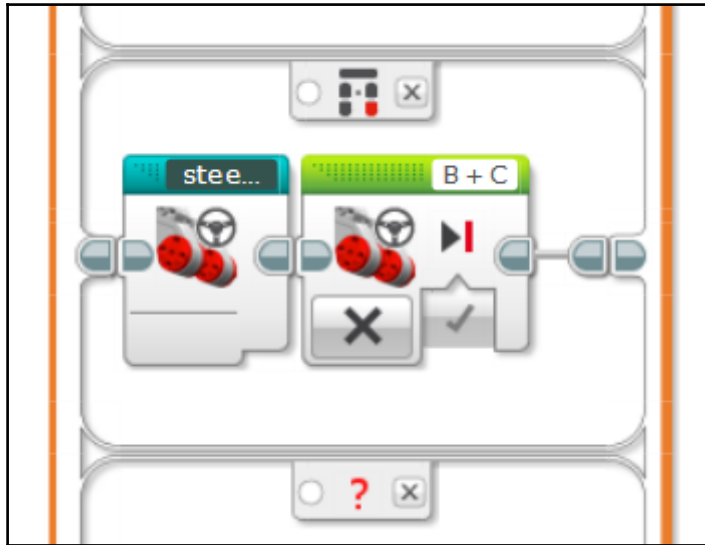
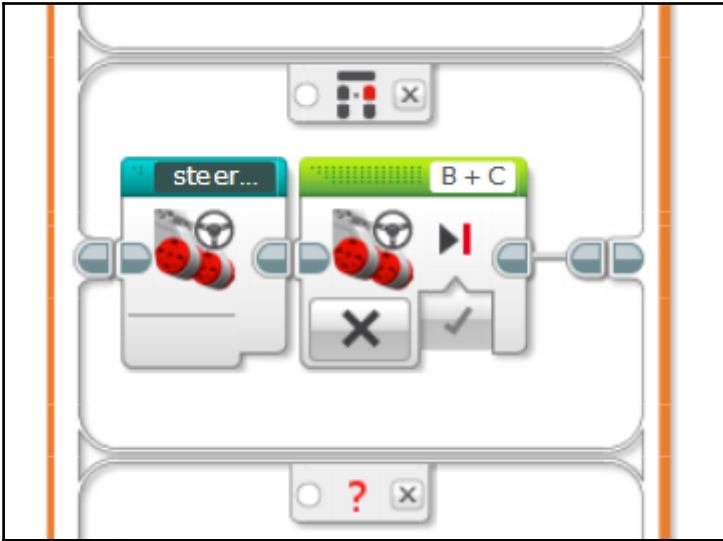

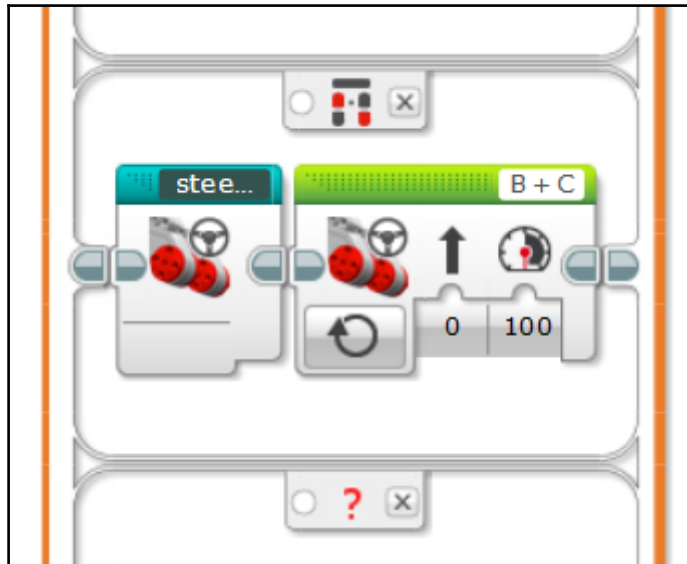
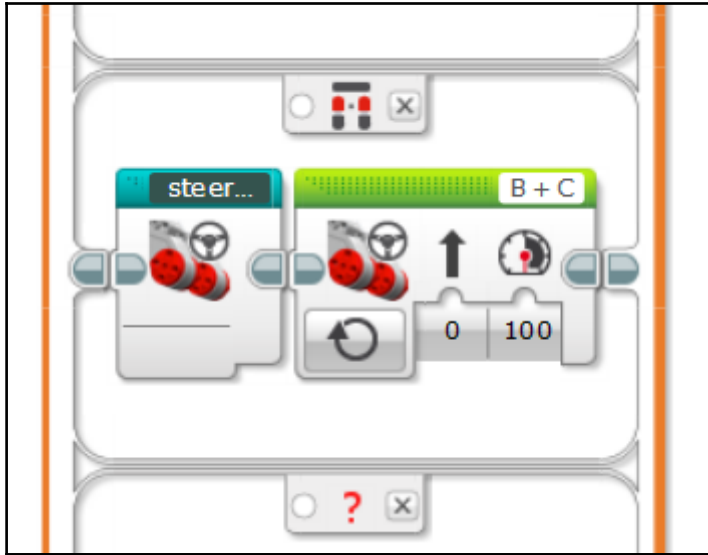

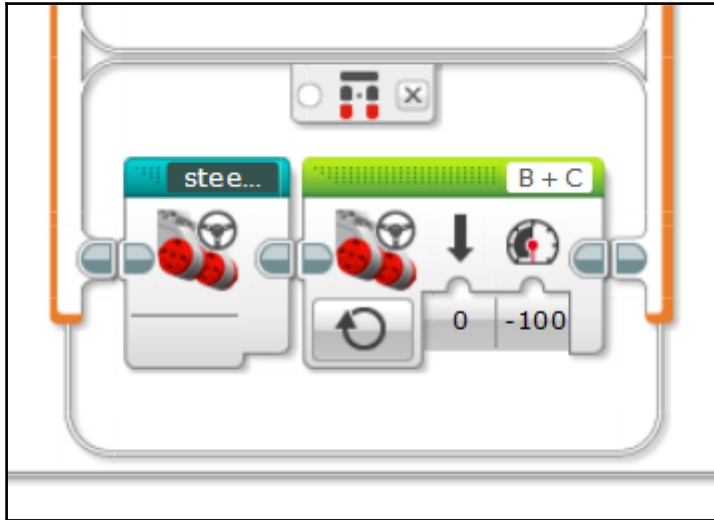
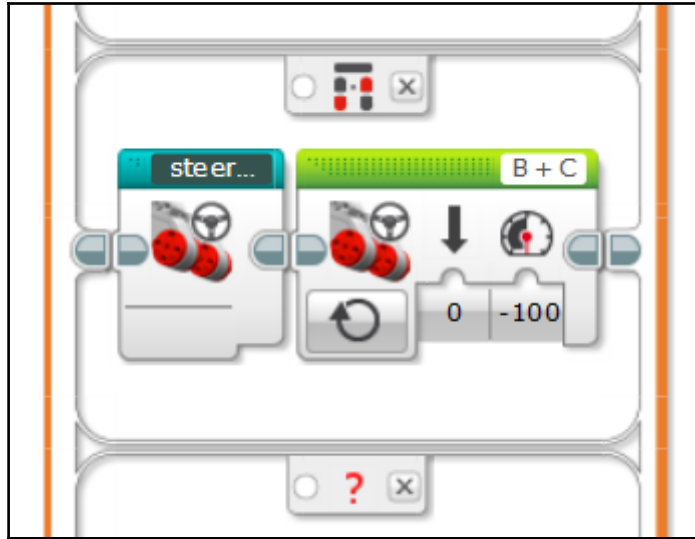

Chapter 07: GPS Car – Autonomous EV3 Navigation



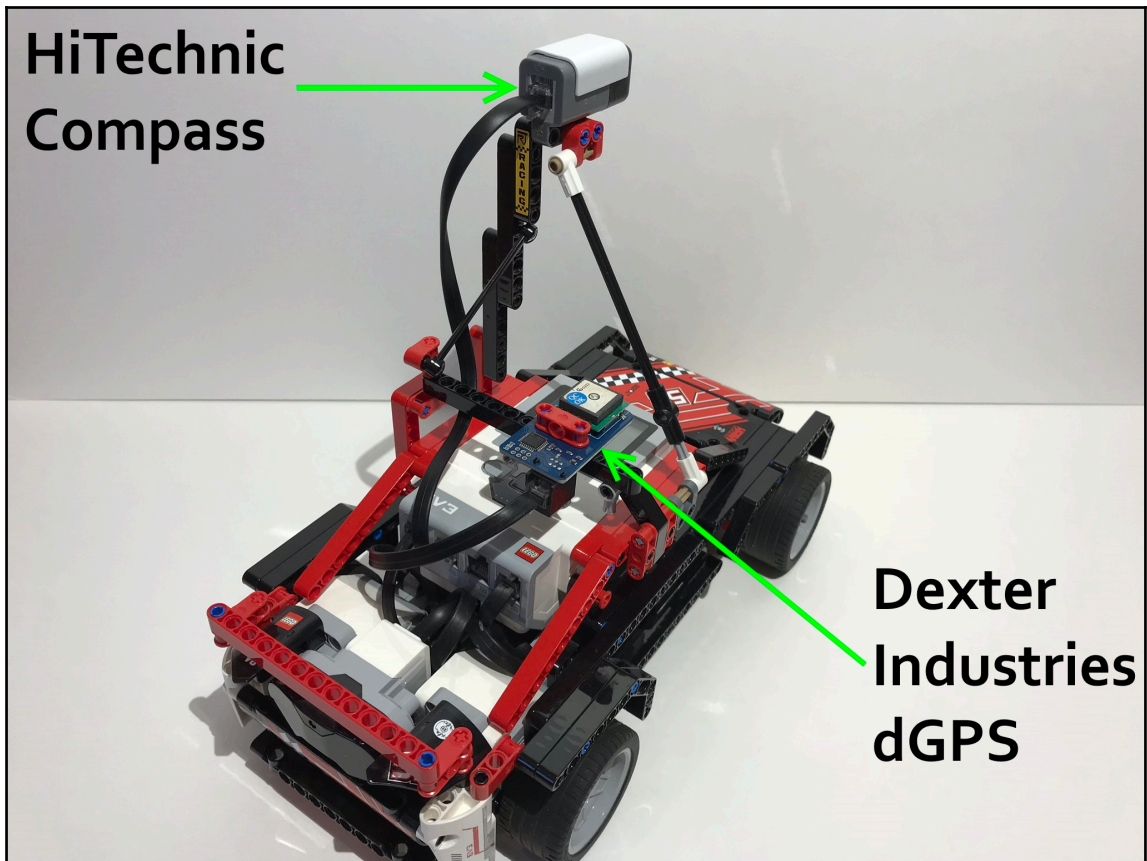

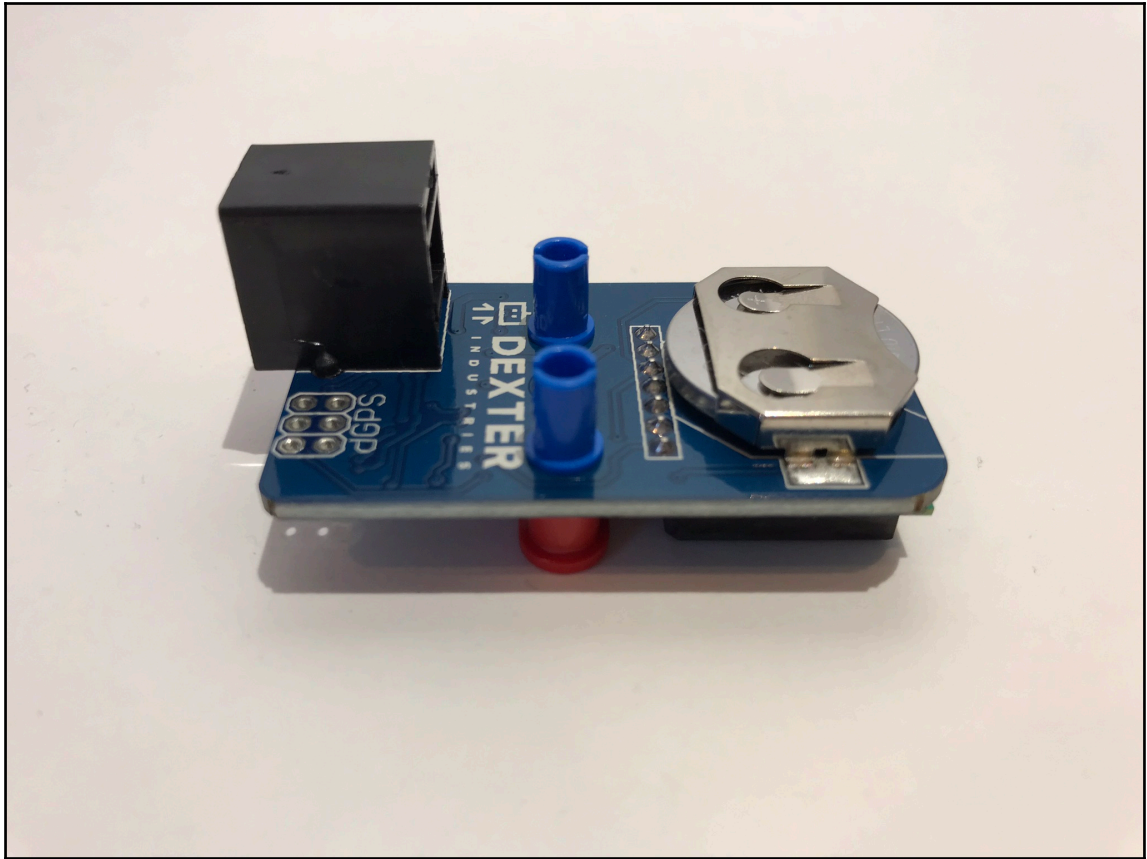



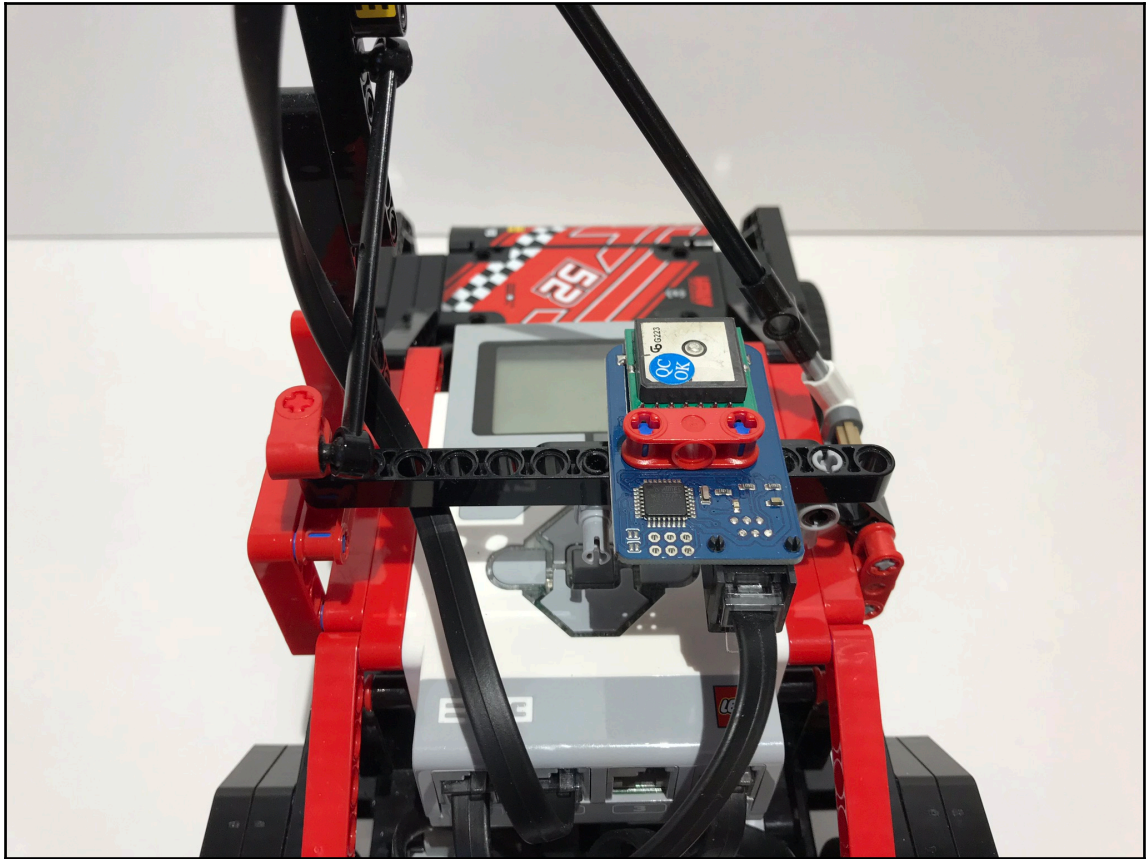



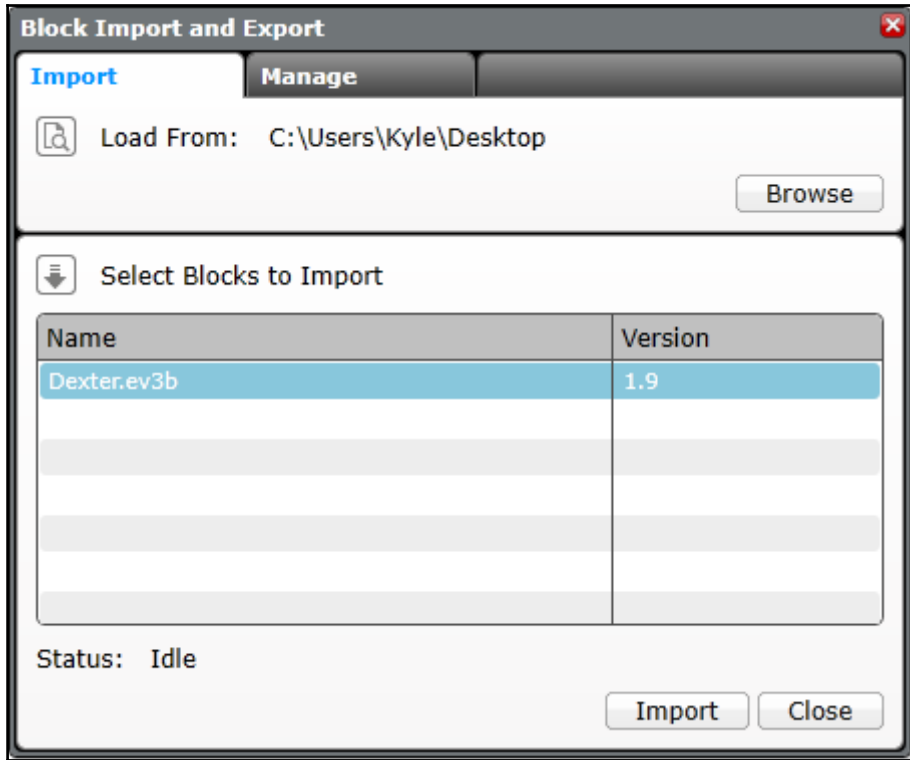

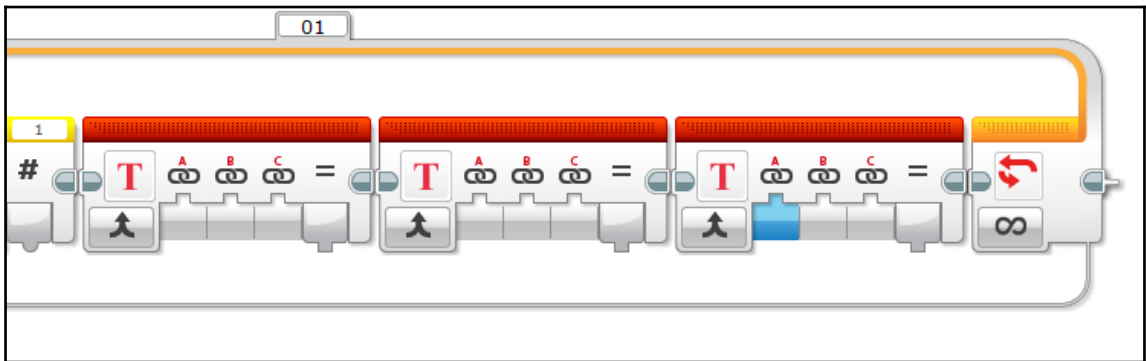
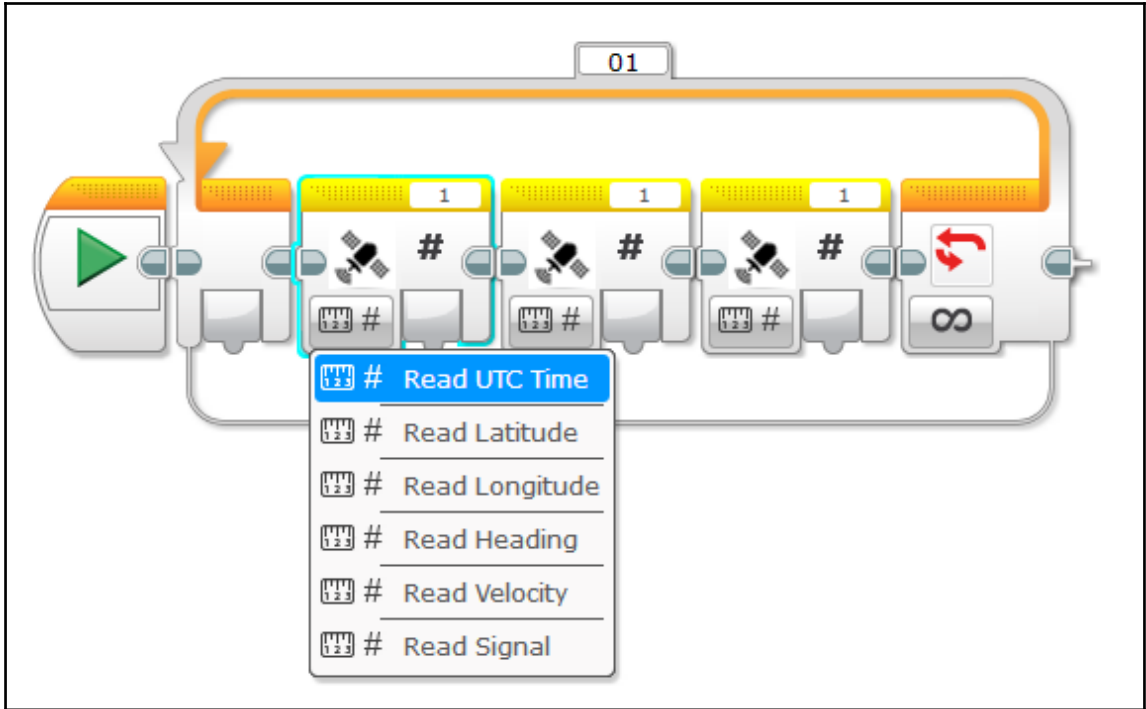

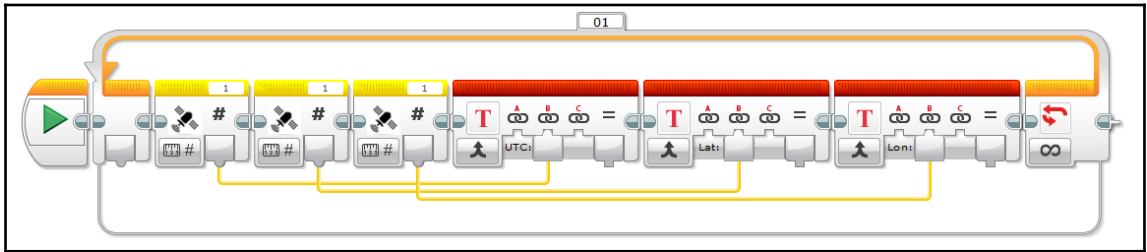
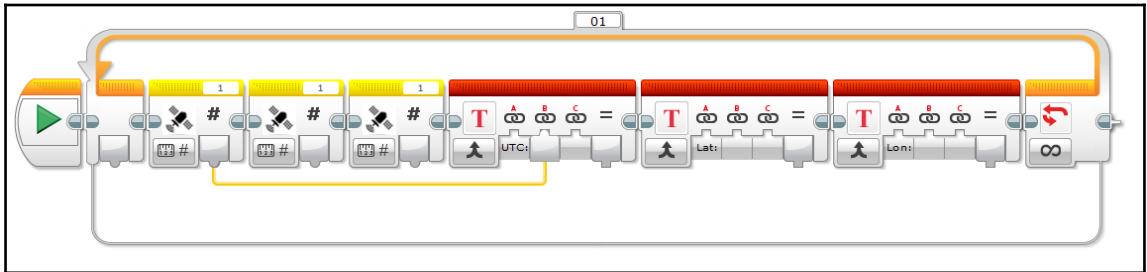
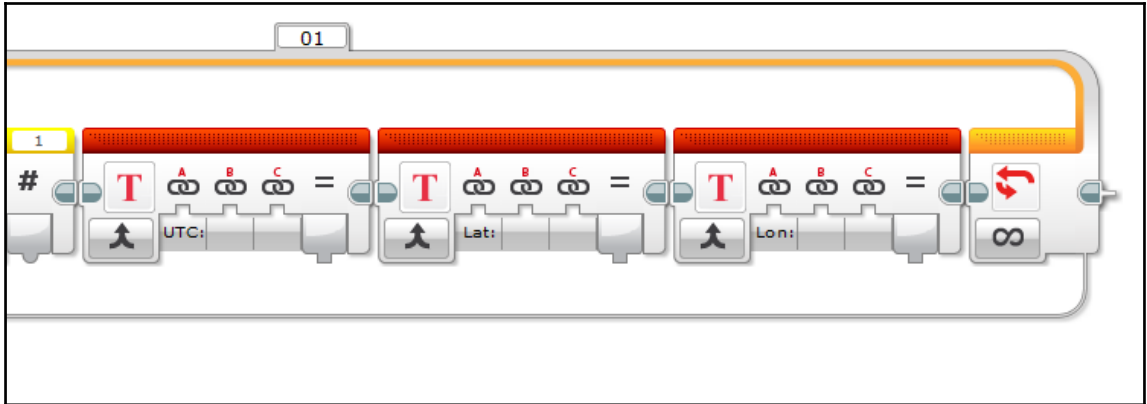

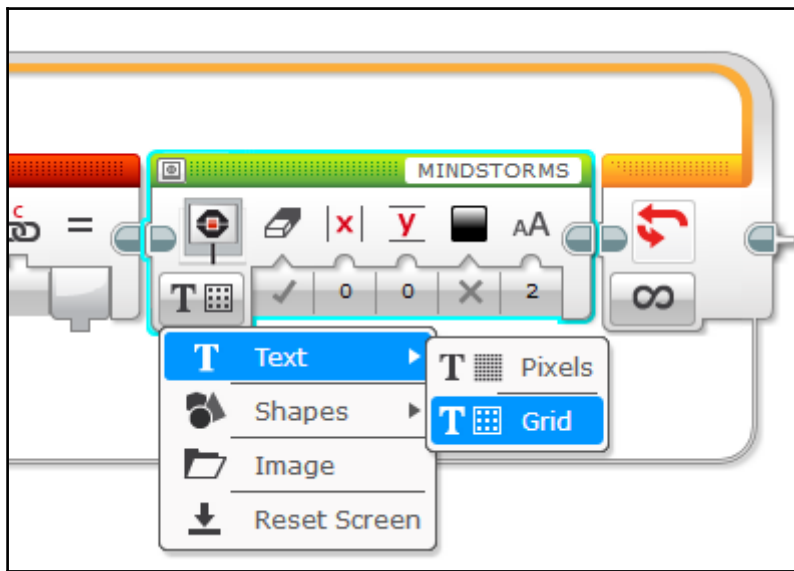
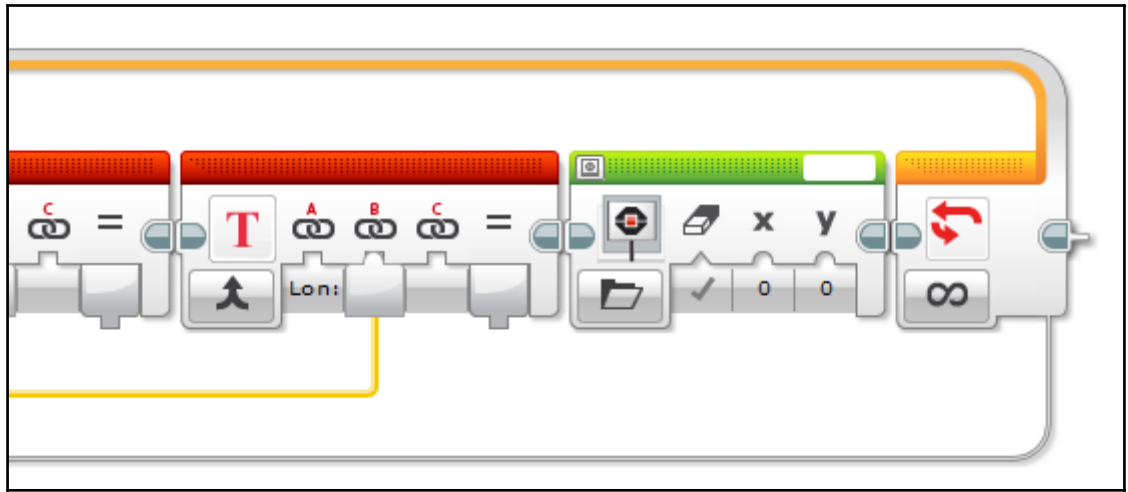

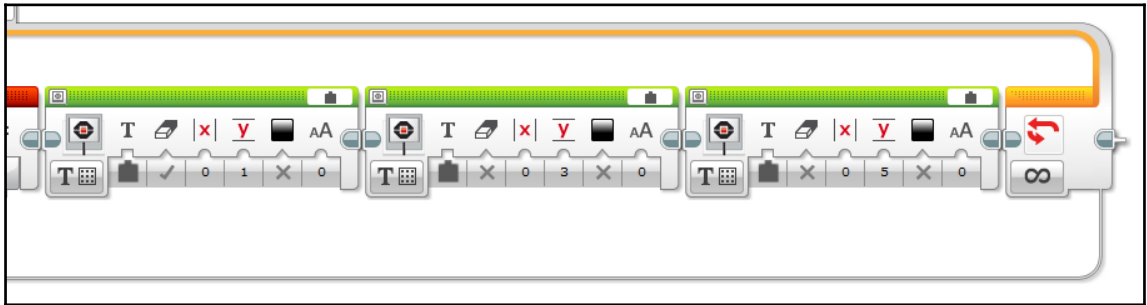
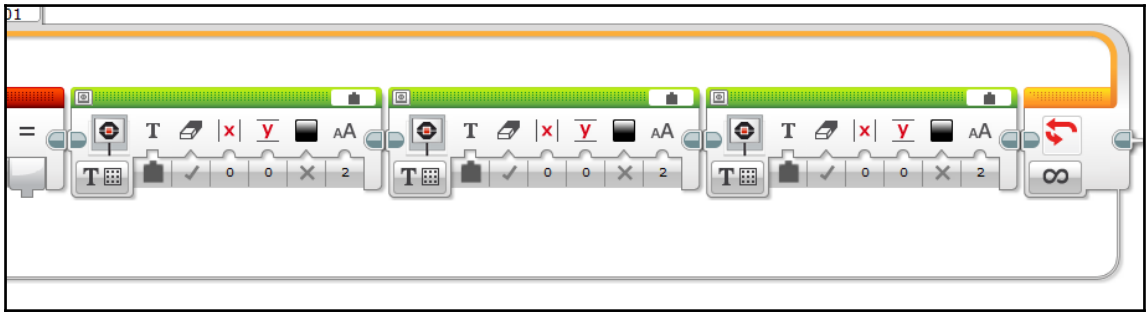
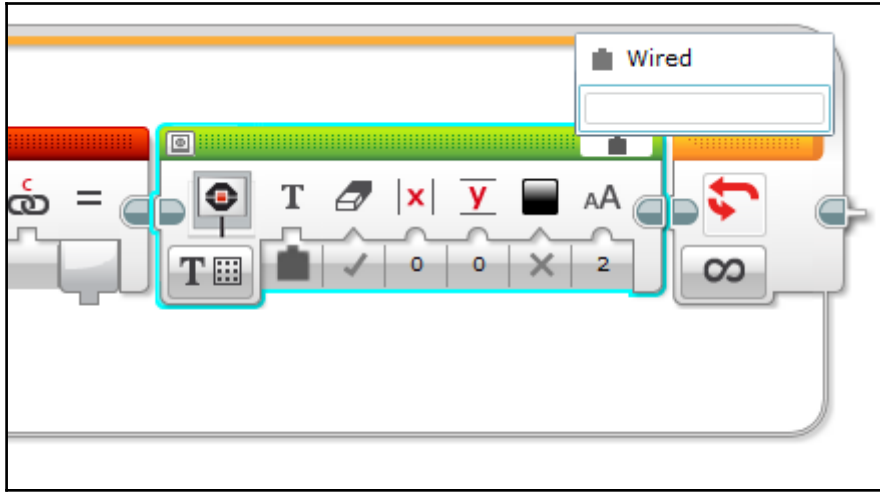

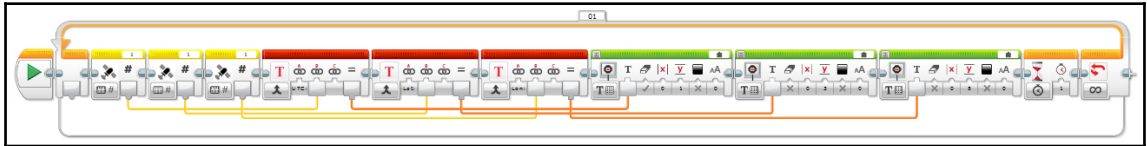
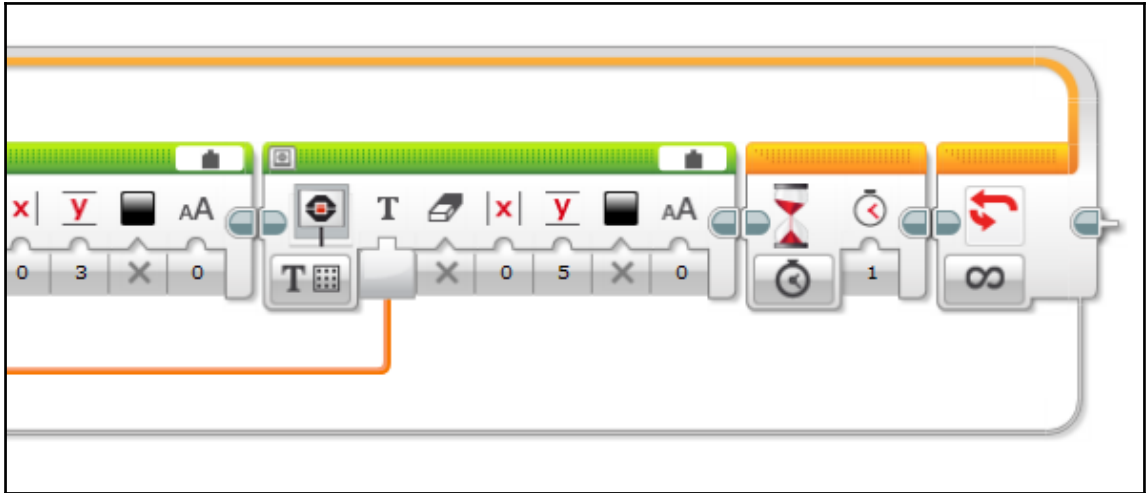
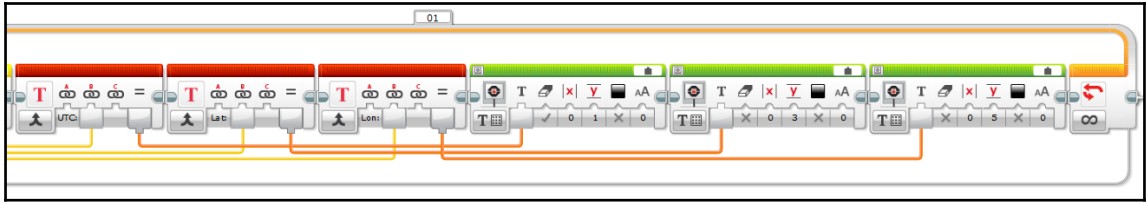

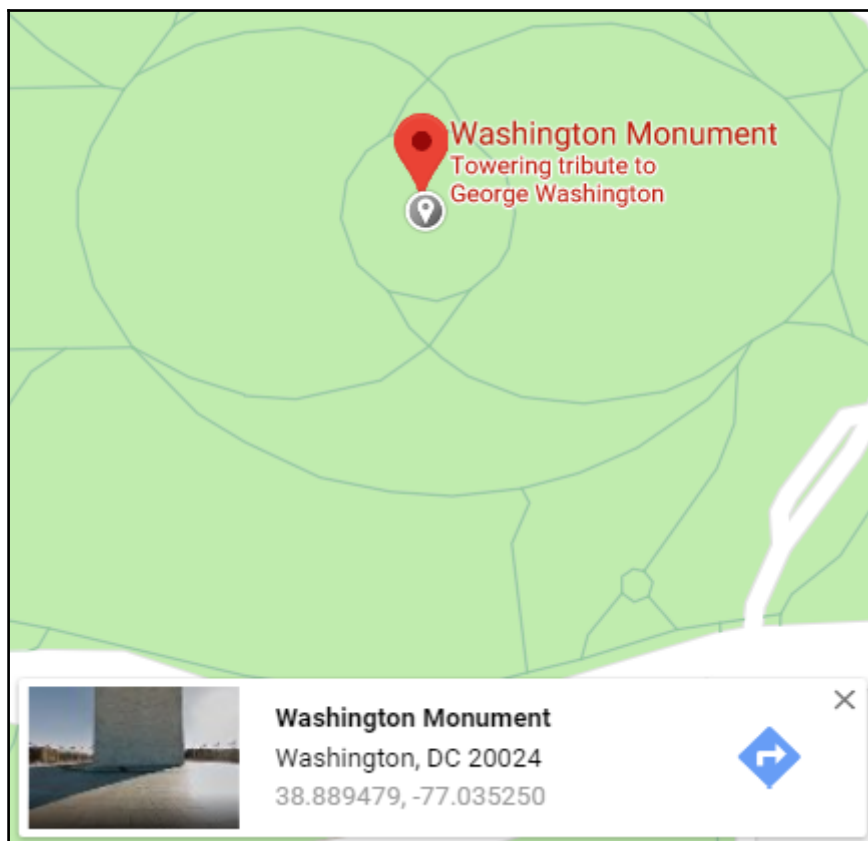

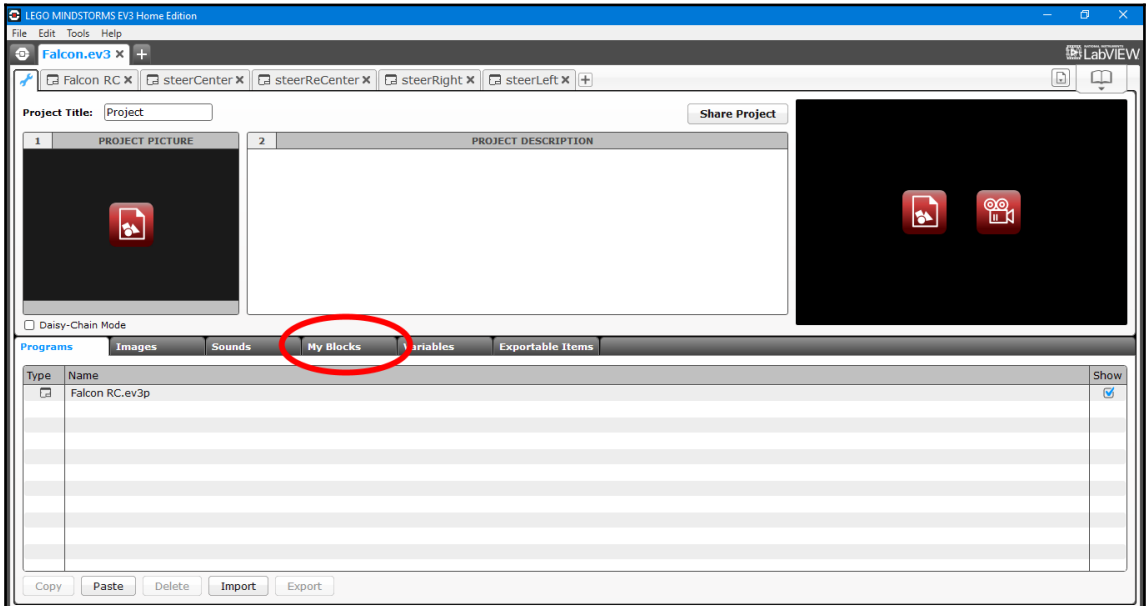
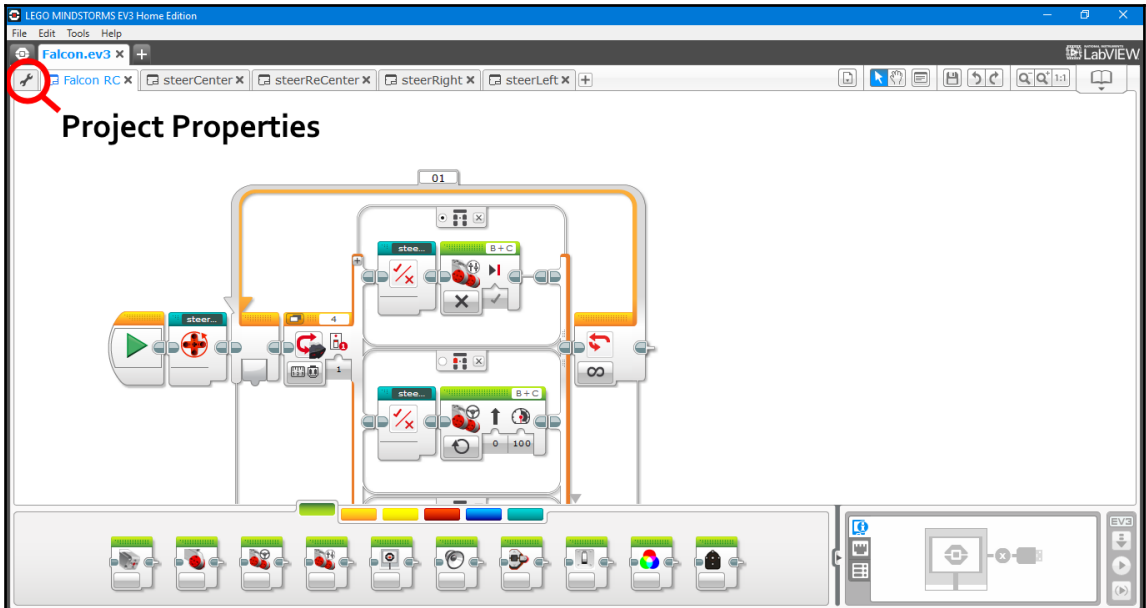

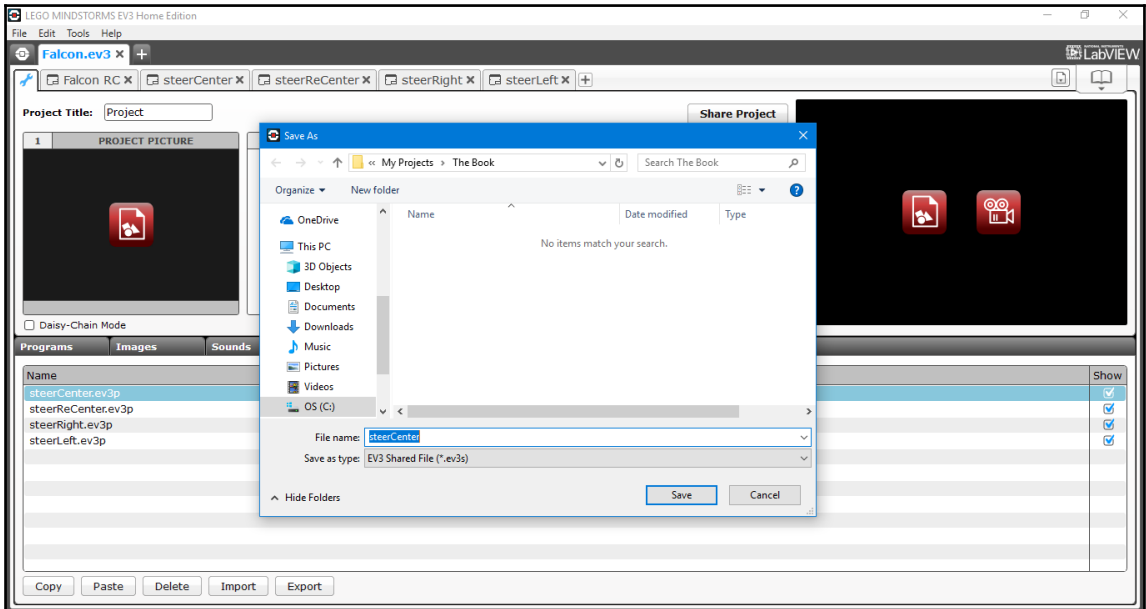
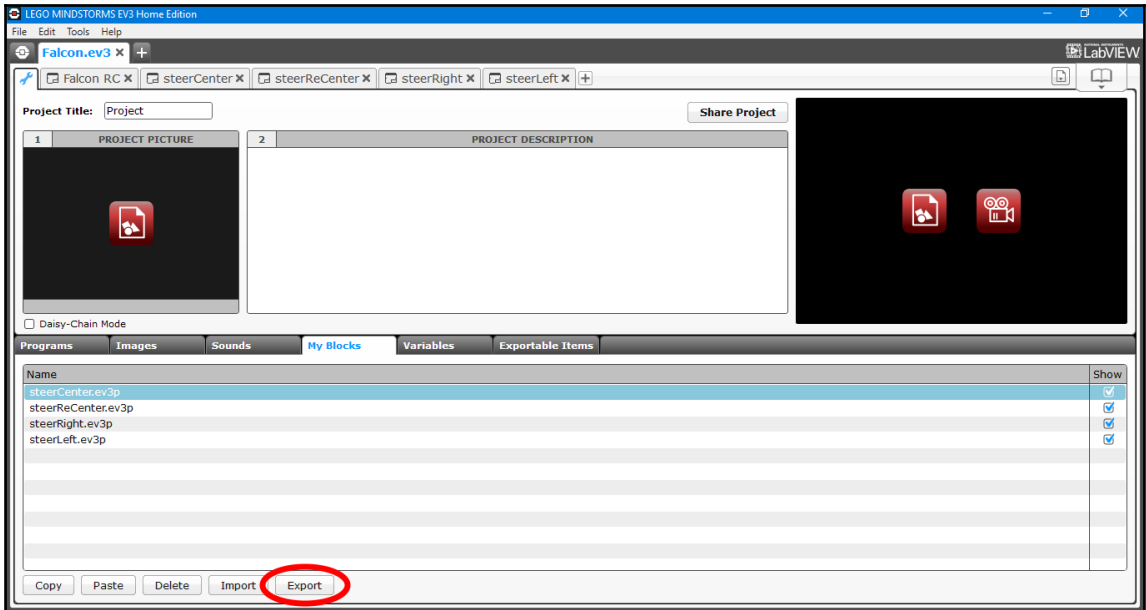

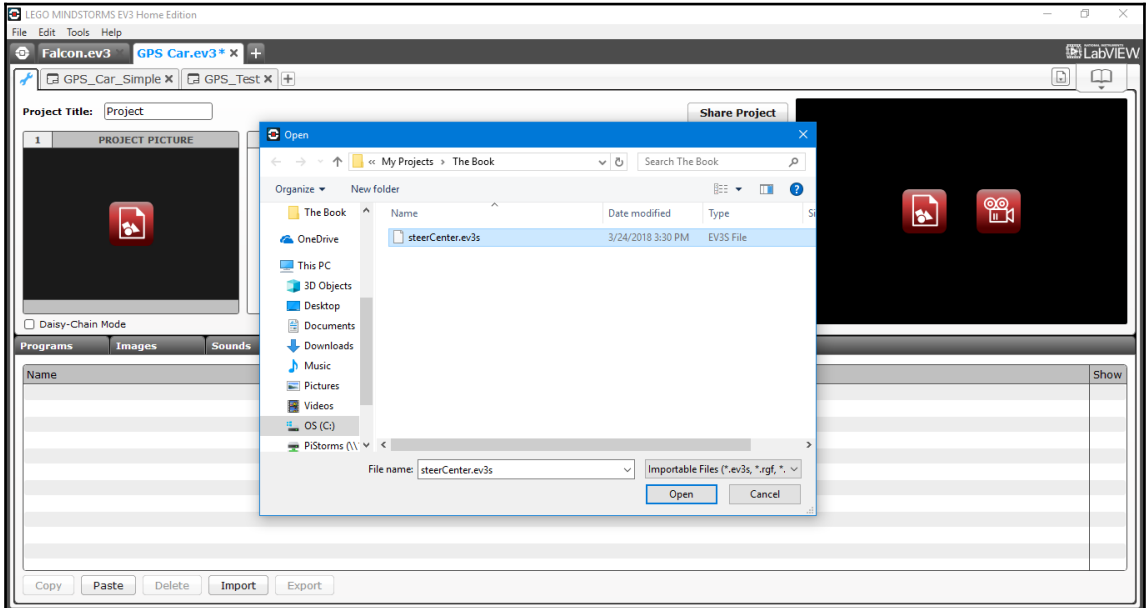
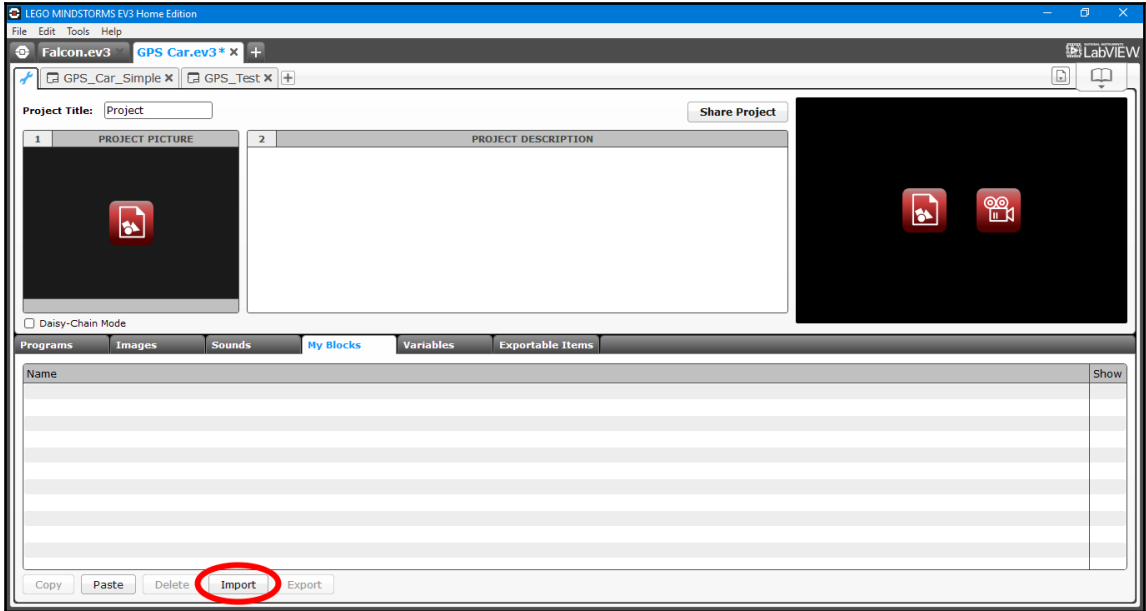

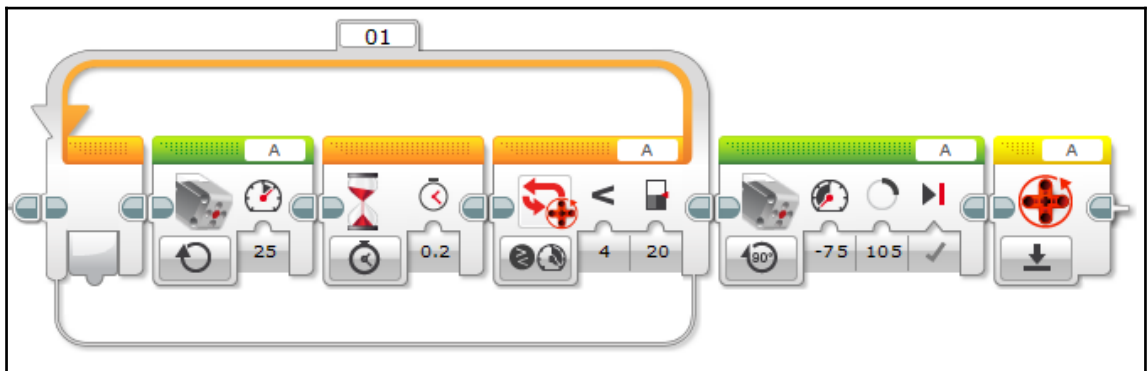
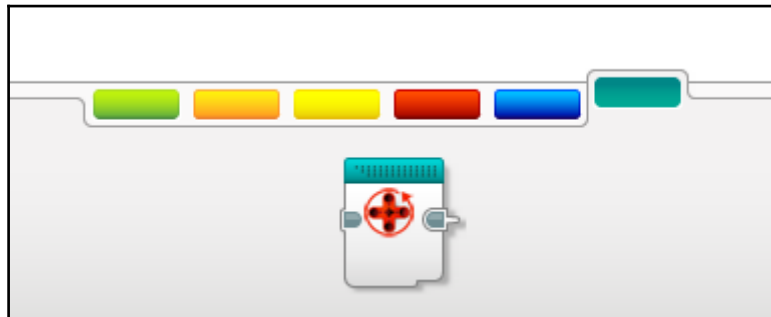
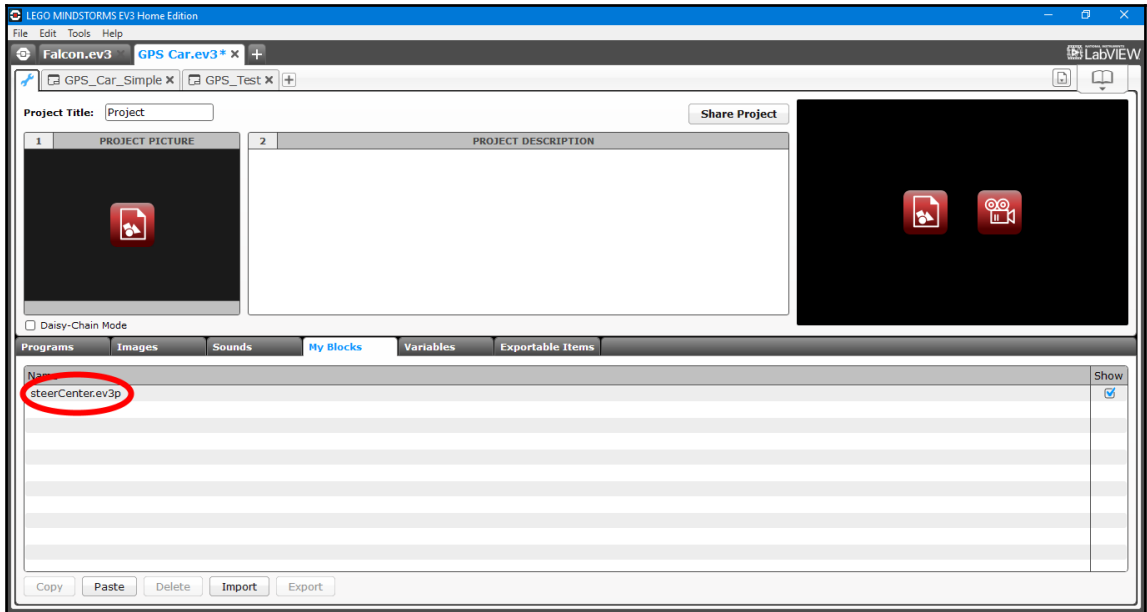

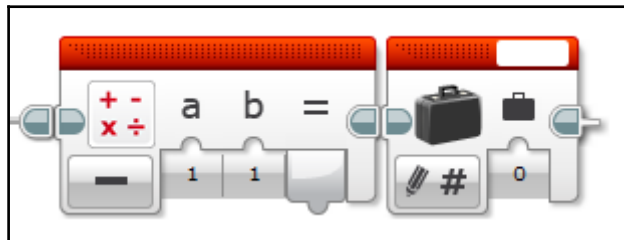
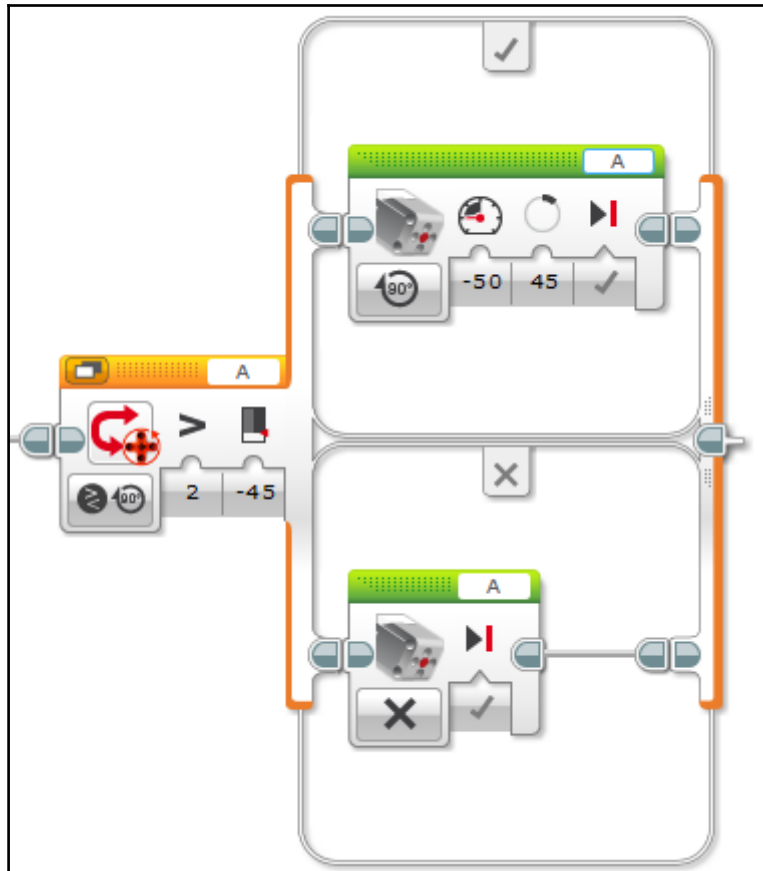

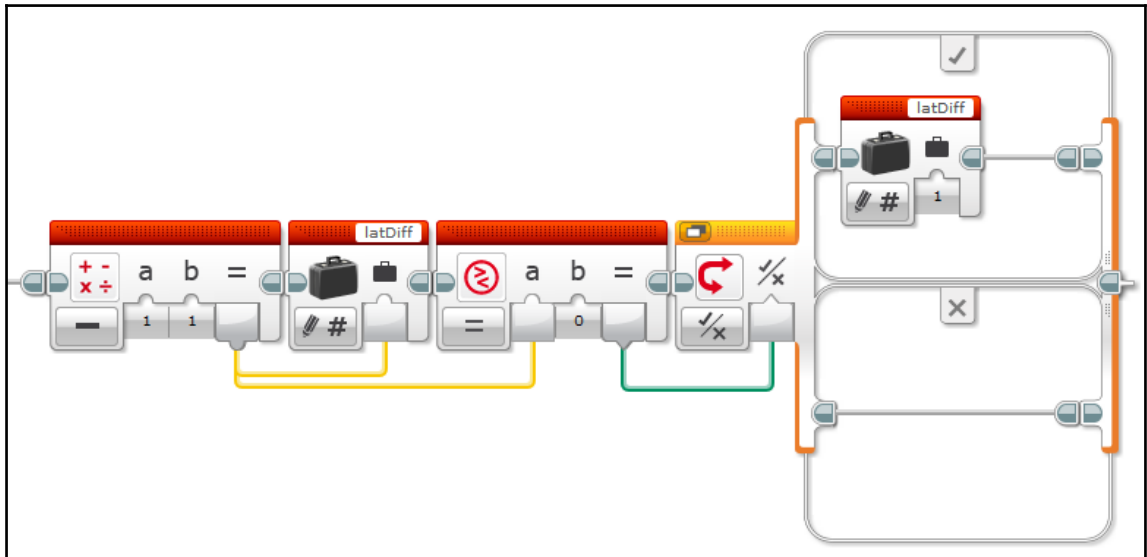
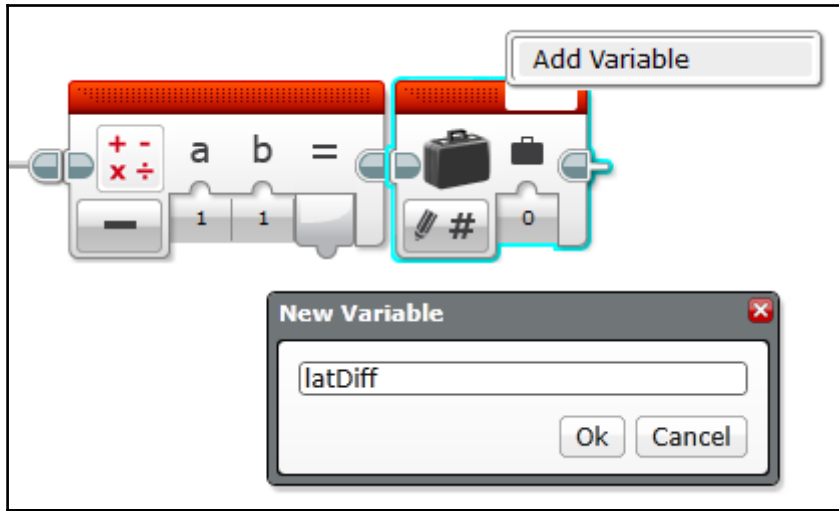

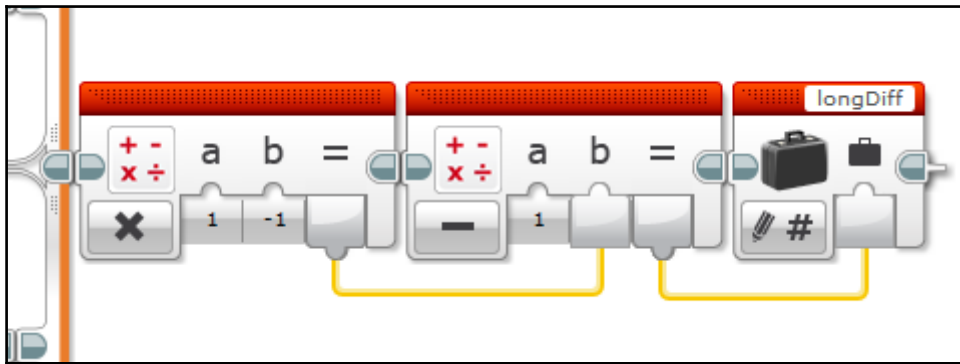
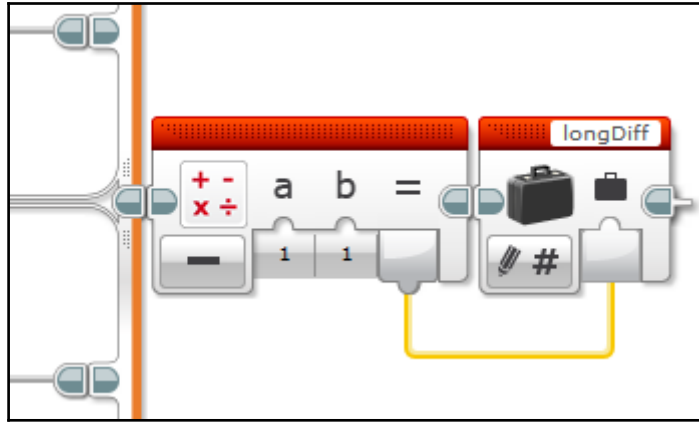

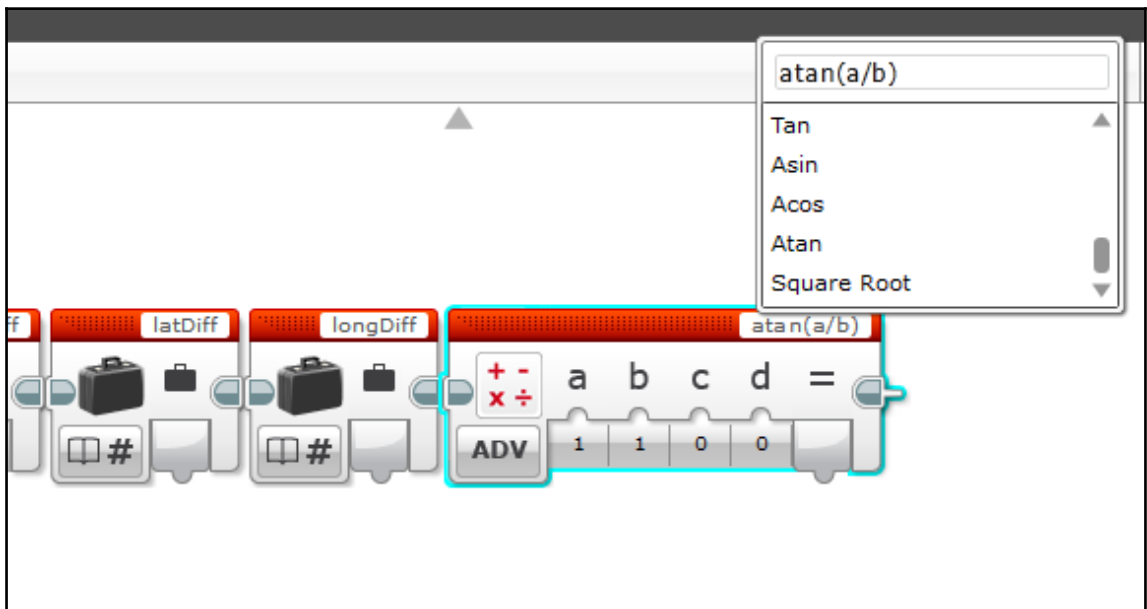
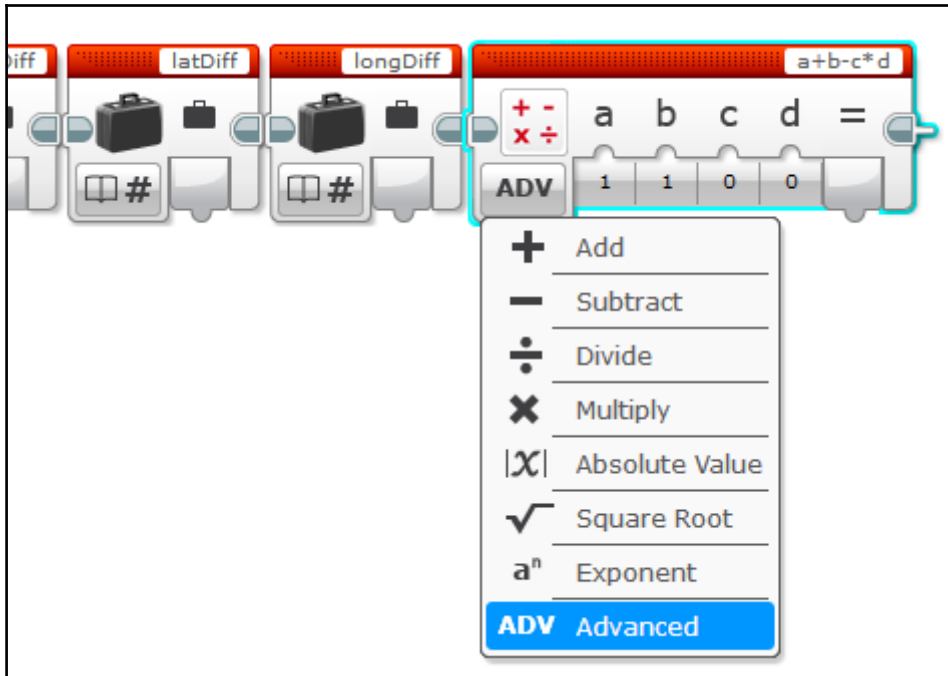

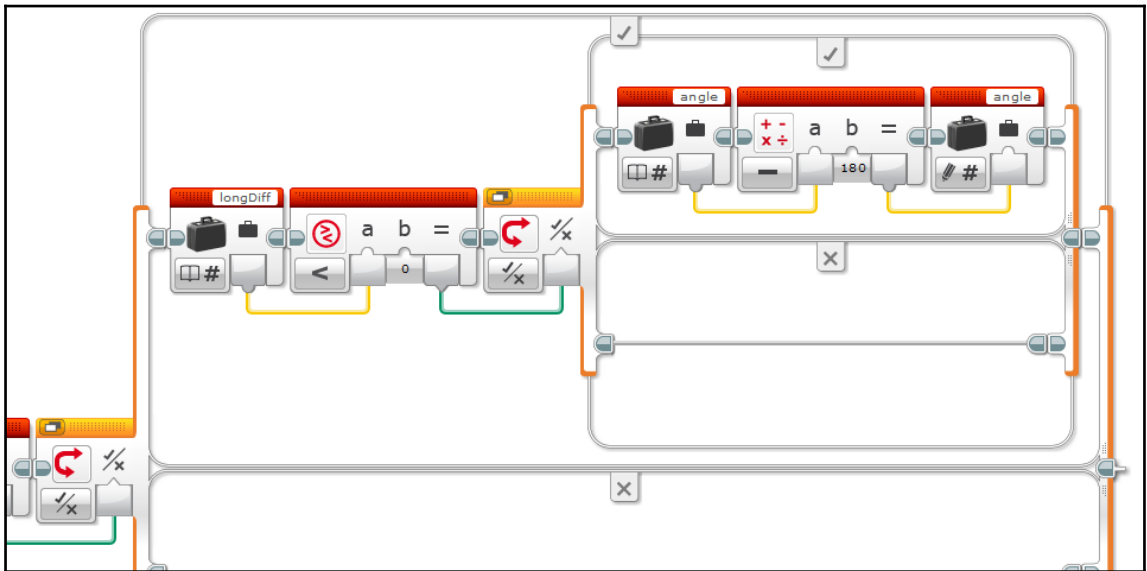
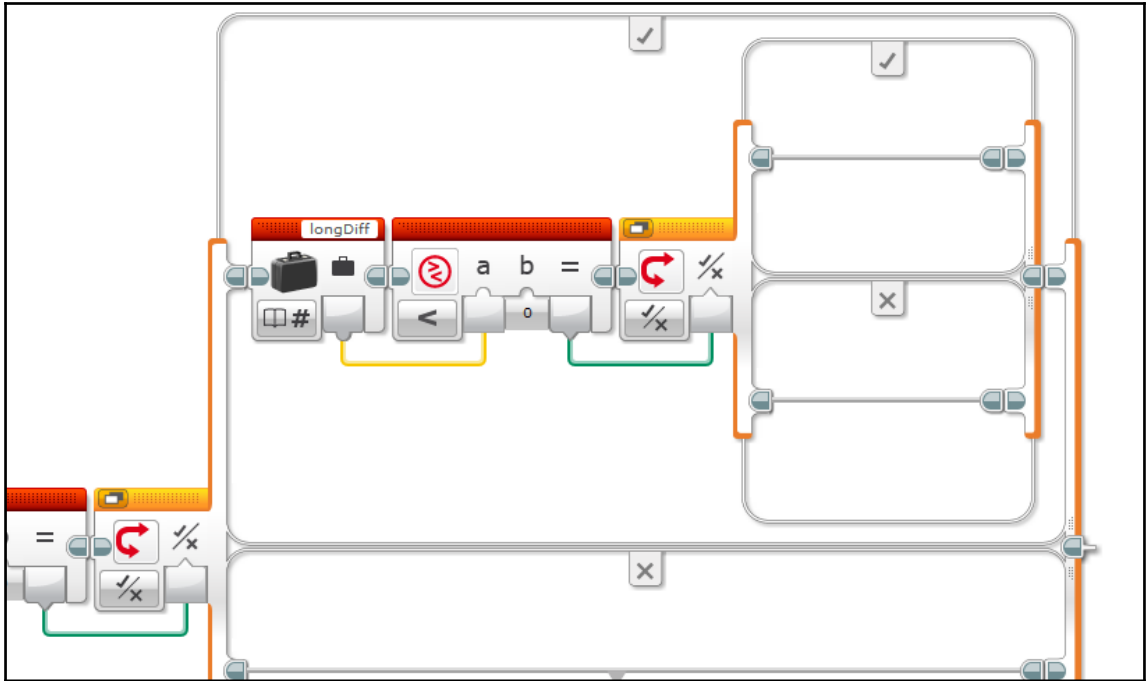

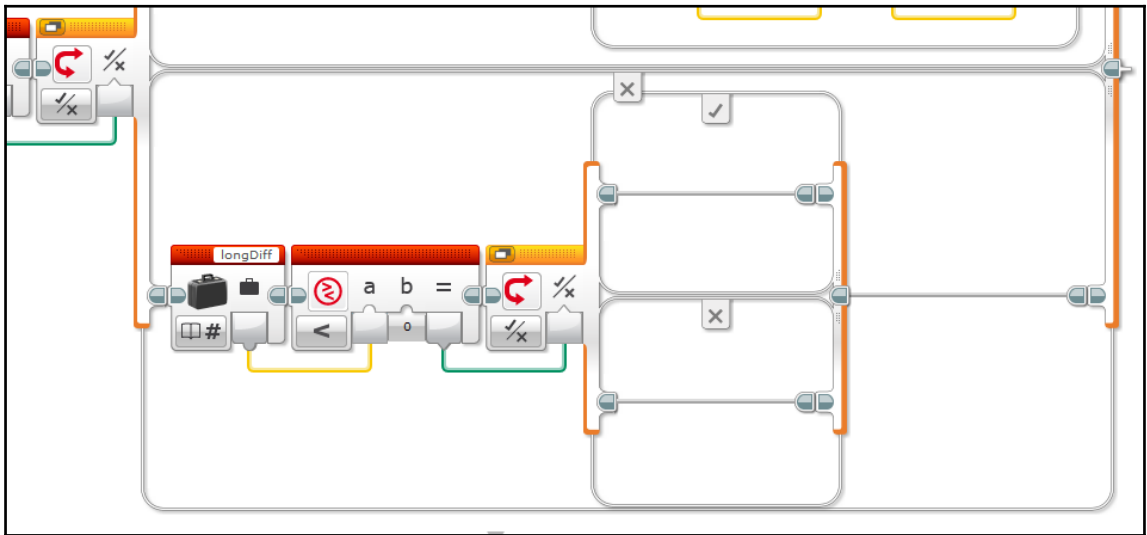
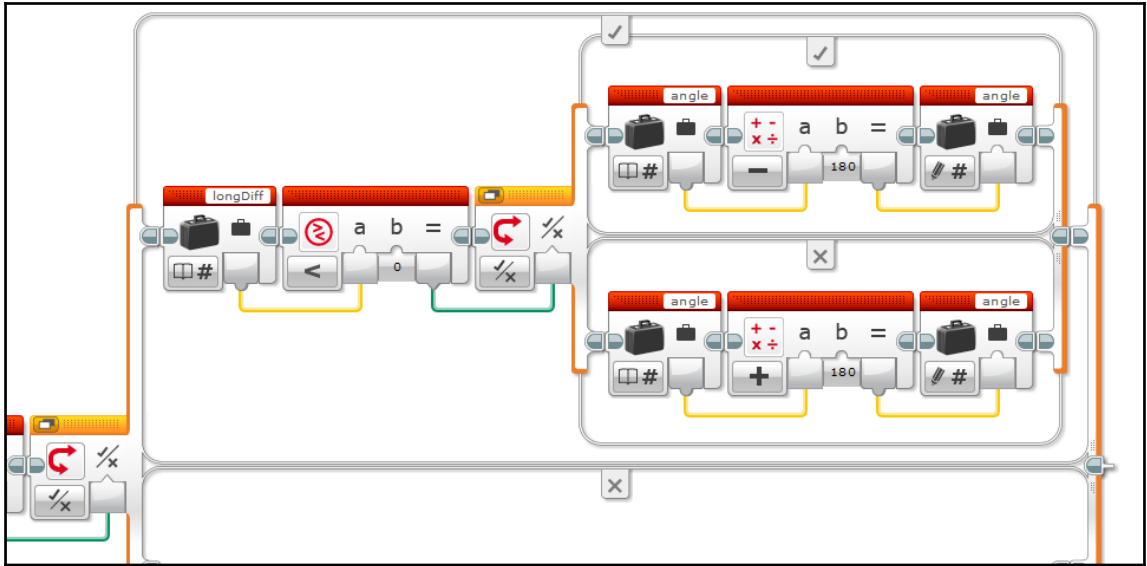

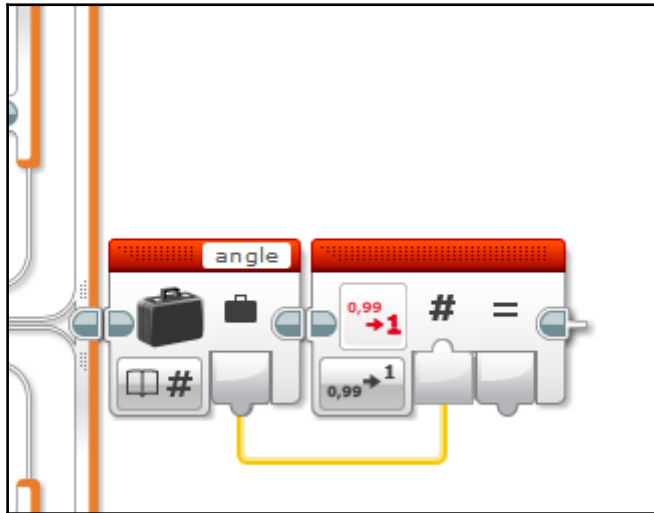
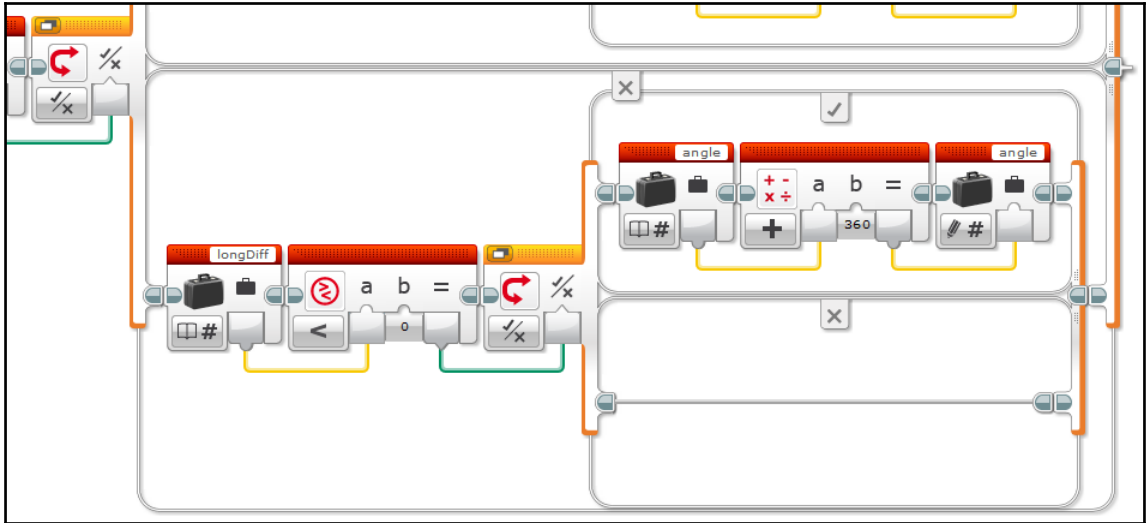

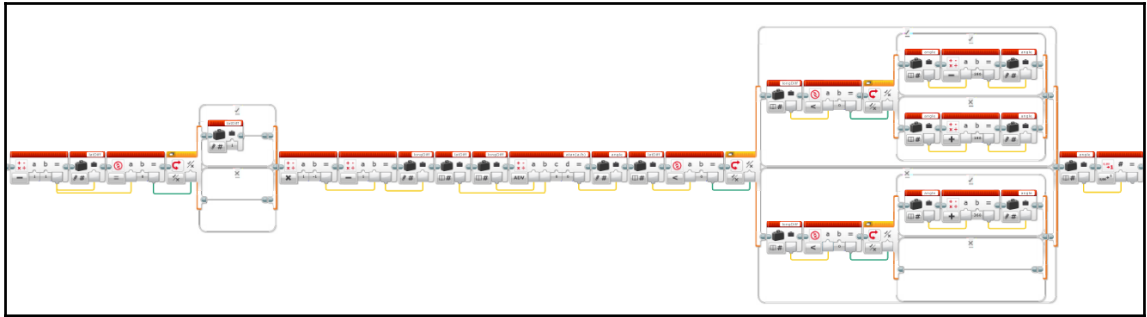

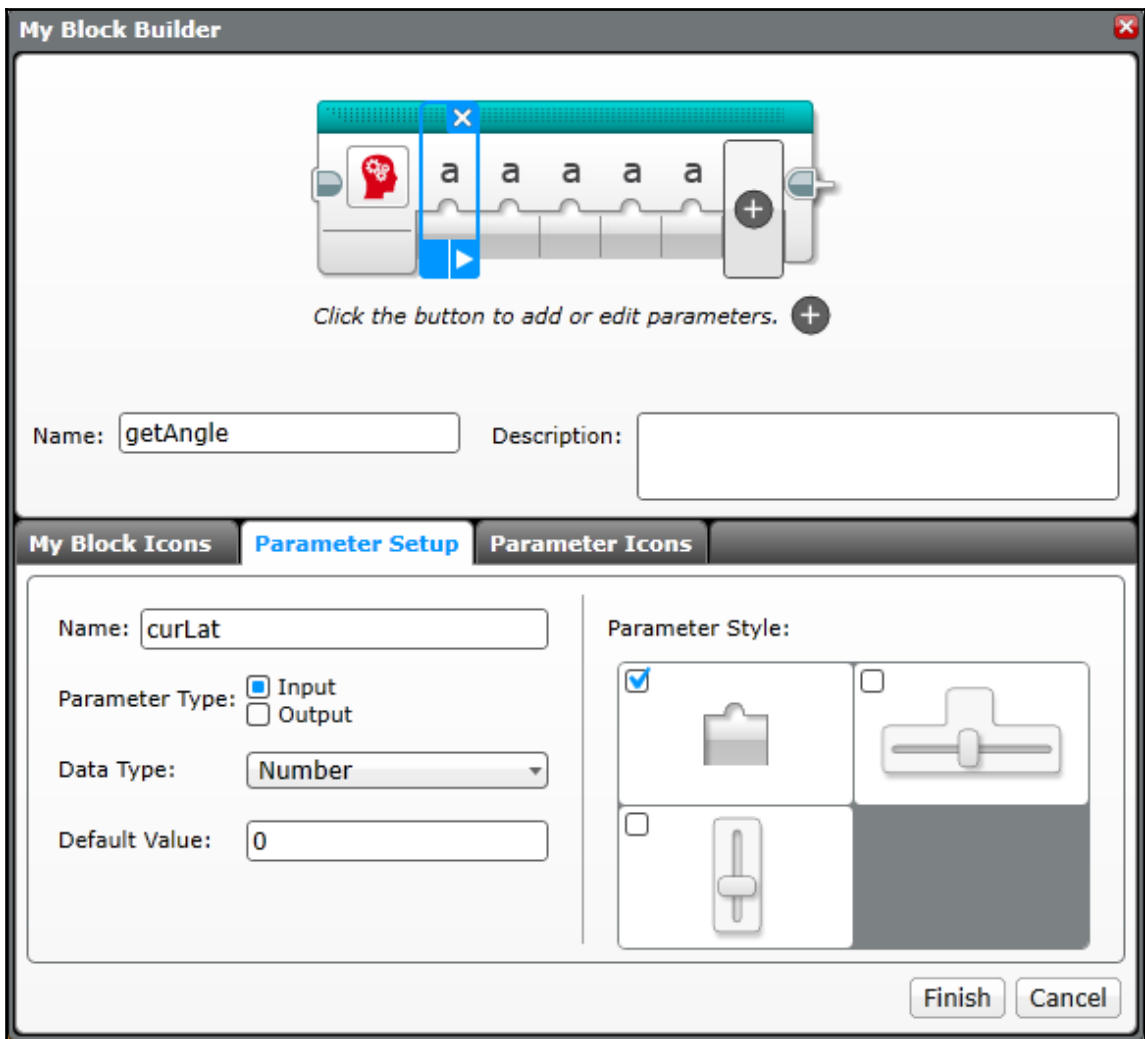

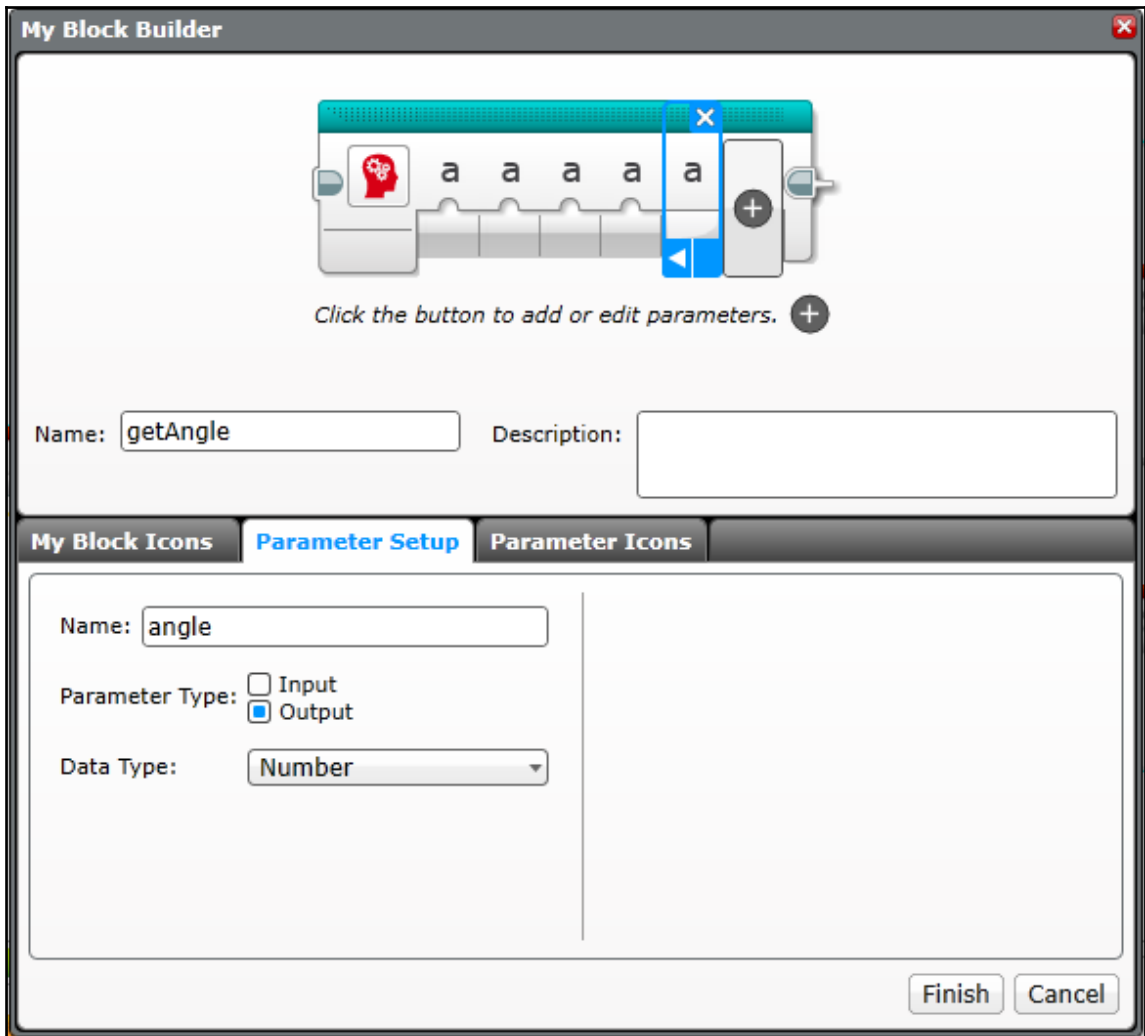



My Block Builder ✖



Click the button to add or edit parameters. +

Name: Description:

My Block Icons
Parameter Setup
Parameter Icons

a	b	c	d	1	2	3	4	#	÷	T	■	□
■	■	■	■	■	■	x	y	x1	y1	x2	y2	x
y	↔	↕	=	≠	>	≦	<	≠	n	°/°	#	#→
↔	→#	→#	→#	°C	°F	cm	Inch		dB	dBa	A	Hz
J	V	W	d/s	↙	↘	○	□	▭	▭	○	○	○

