

Chapter 1: An Introduction to Microservices

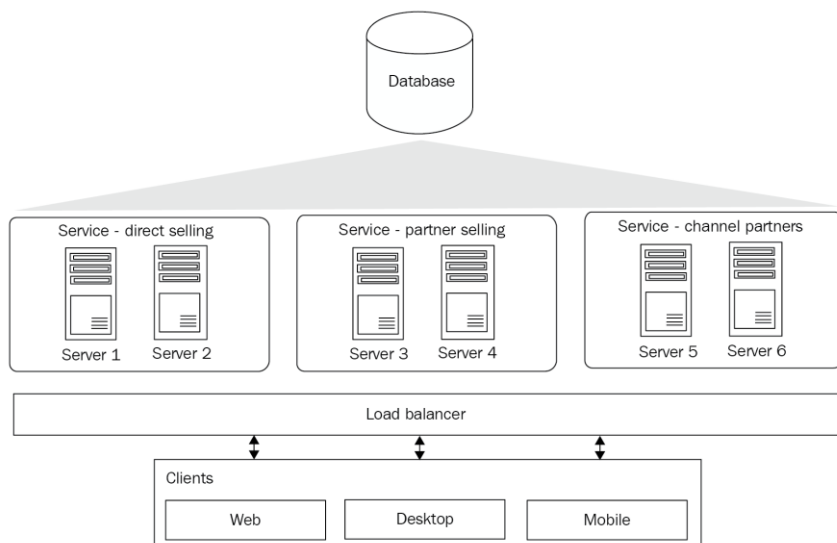

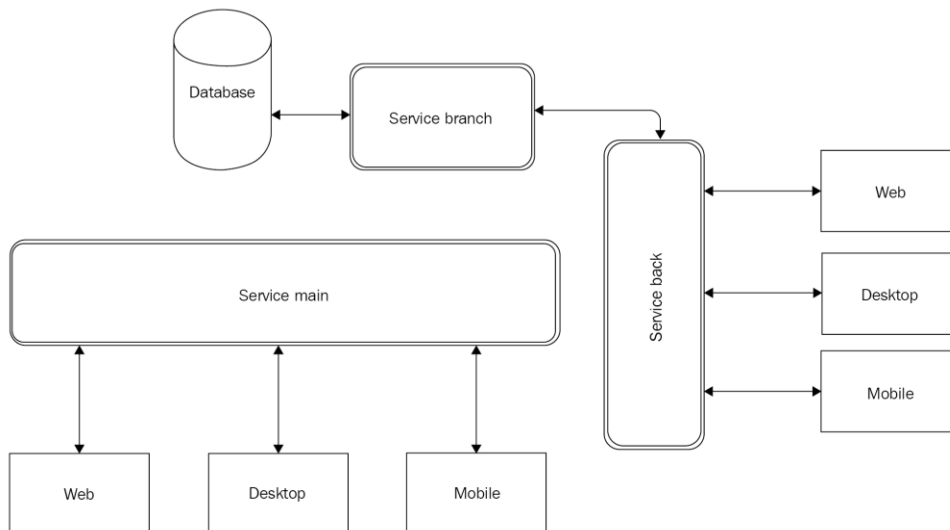

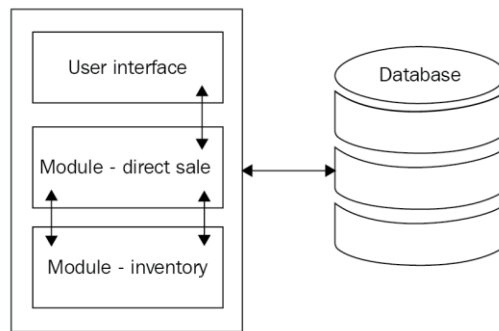

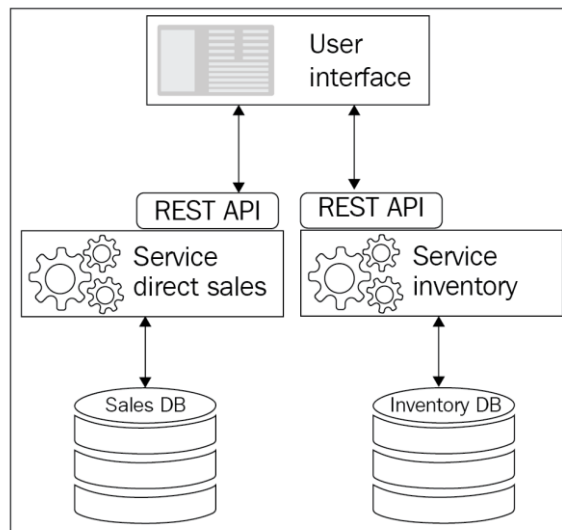
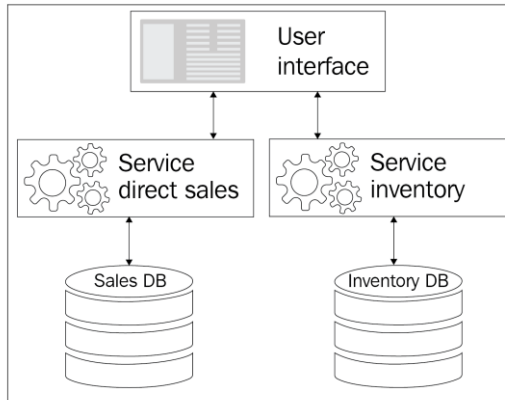
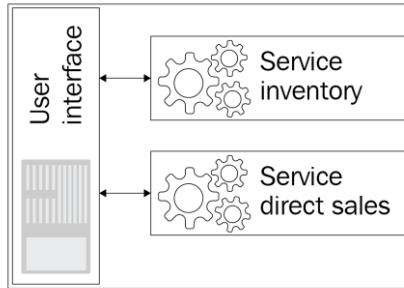
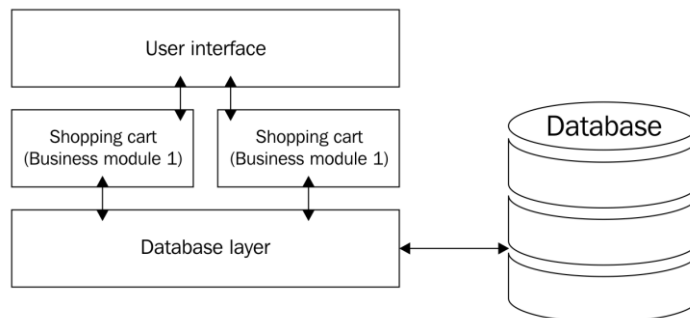
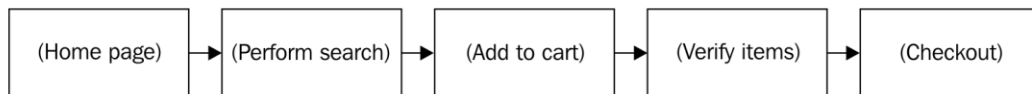
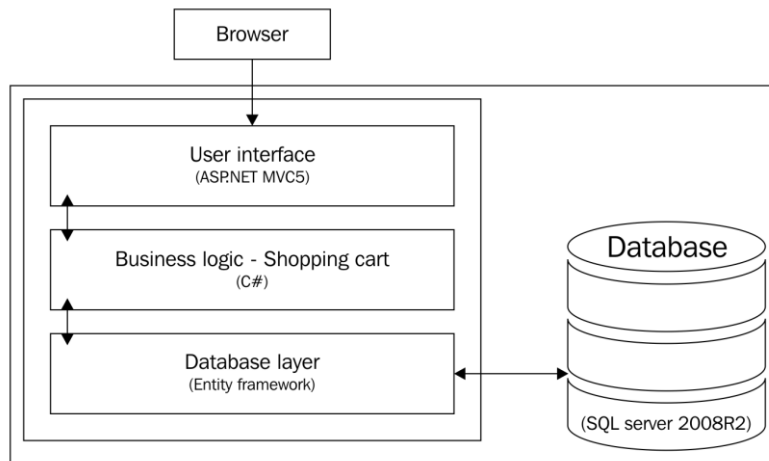
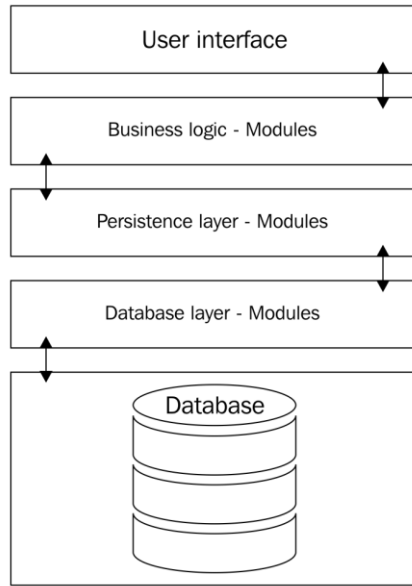
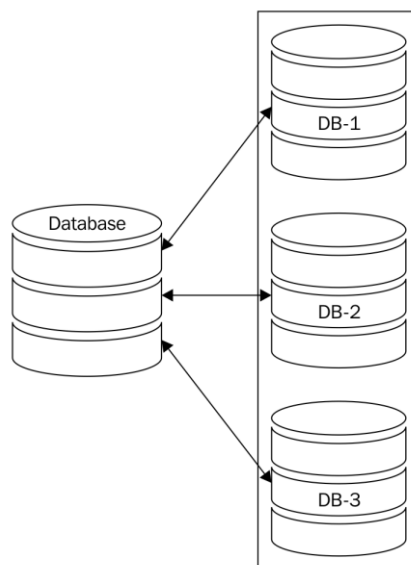
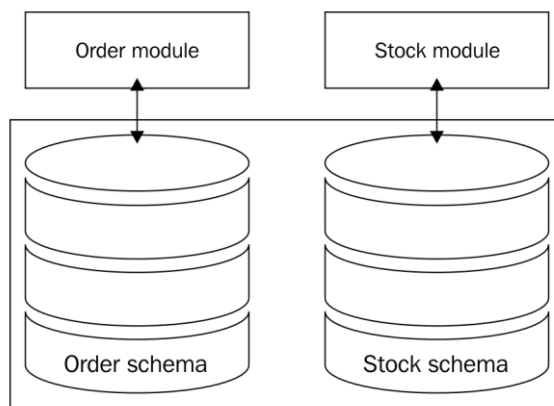
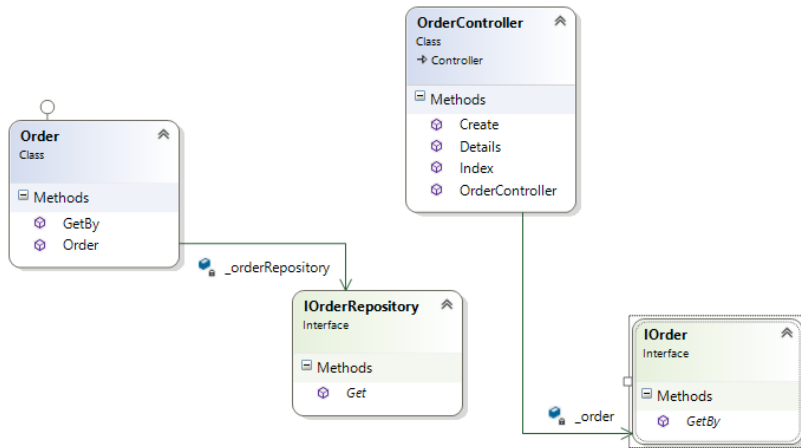

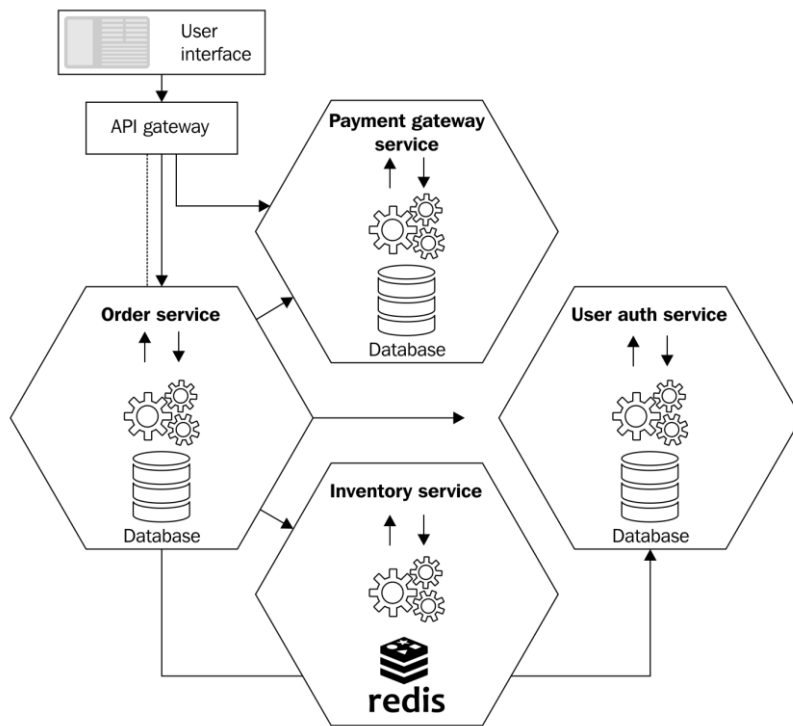
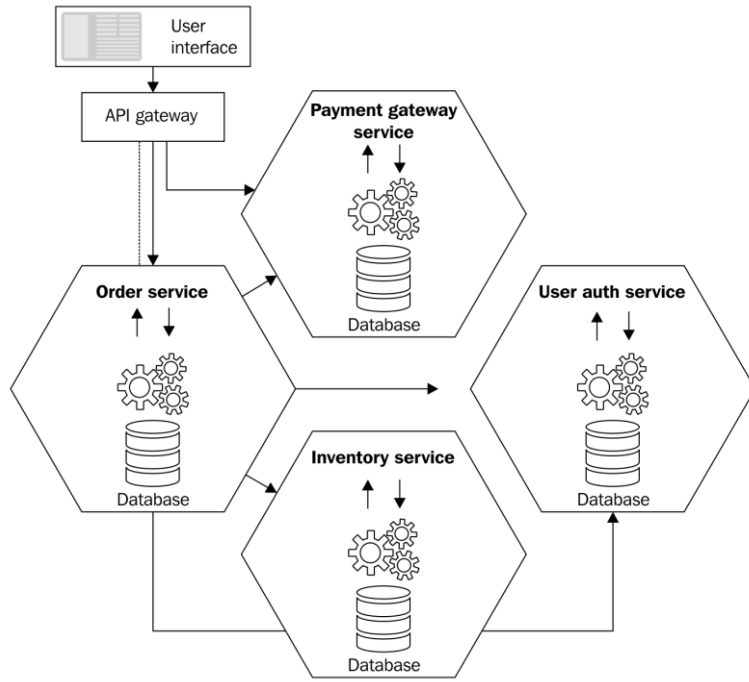

Chapter 2: Implementing Microservices

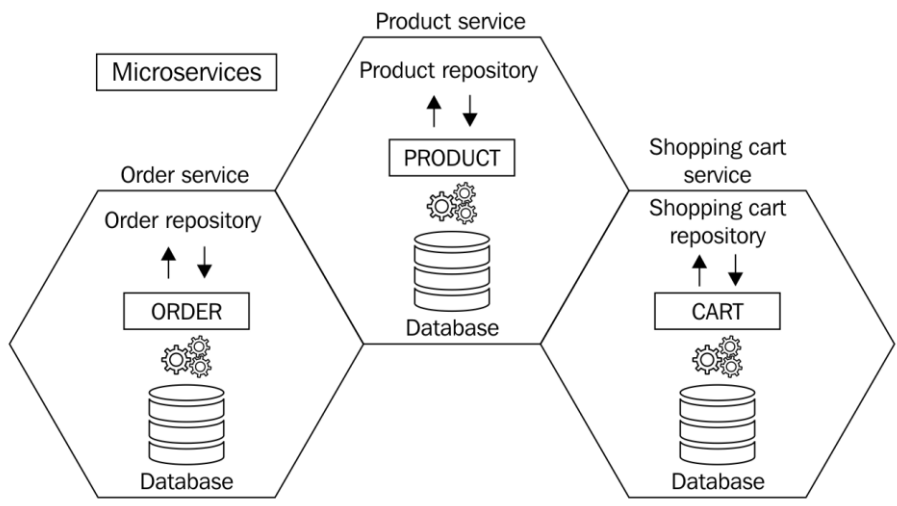
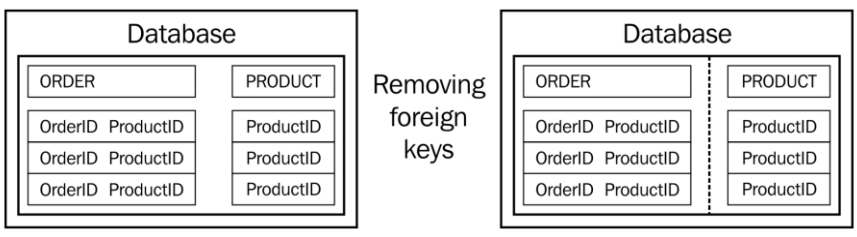
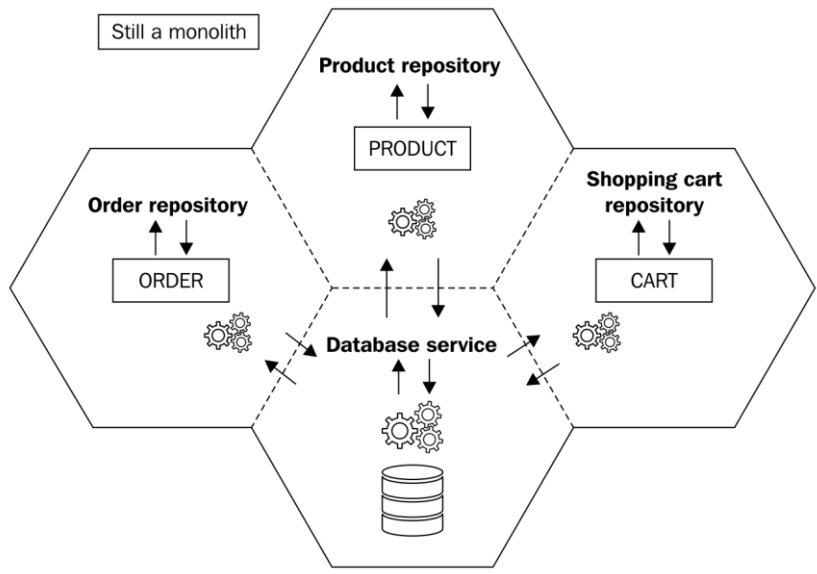

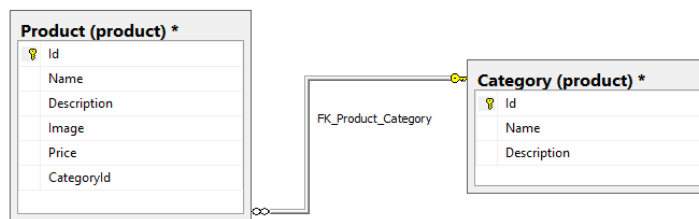
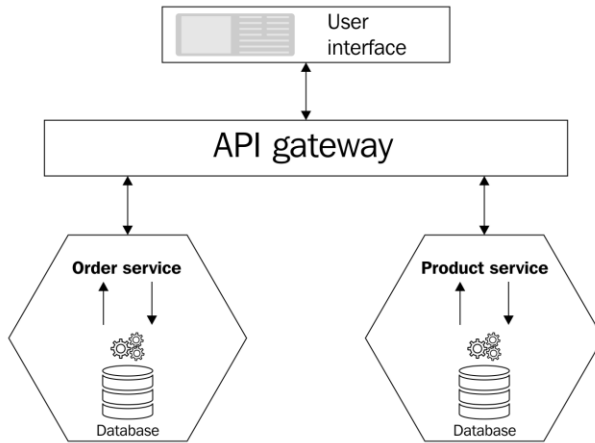

product.Product [Design] | product.Category [Design]

Update | Script File: product.Product.sql

Name	Data Type	Allow Nulls	Default
Id	uniqueidentifier	<input type="checkbox"/>	
Name	nvarchar(50)	<input type="checkbox"/>	
Description	nvarchar(250)	<input type="checkbox"/>	
Image	varchar(150)	<input checked="" type="checkbox"/>	
Price	decimal(14,2)	<input type="checkbox"/>	
CategoryId	uniqueidentifier	<input type="checkbox"/>	

- Keys (1)
 - PK_Product (Primary Key, Clustered: ID)
- Check Constraints (0)
- Indexes (0)
- Foreign Keys (1)
 - FK_Product_Category (ID)
- Triggers (0)

product.Category [Design] | product.Category.sql

Name	Data Type	Allow Nulls	Default
Id	uniqueidentifier	<input type="checkbox"/>	
Name	nvarchar(50)	<input type="checkbox"/>	
Description	nvarchar(200)	<input type="checkbox"/>	

- Keys (1)
 - PK_Category (Primary Key, Clustered: ID)
- Check Constraints (0)
- Indexes (0)
- Foreign Keys (0)
- Triggers (0)

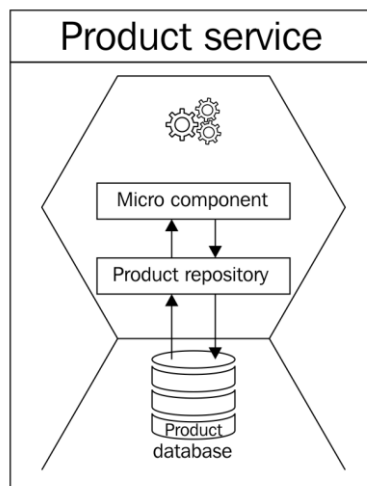

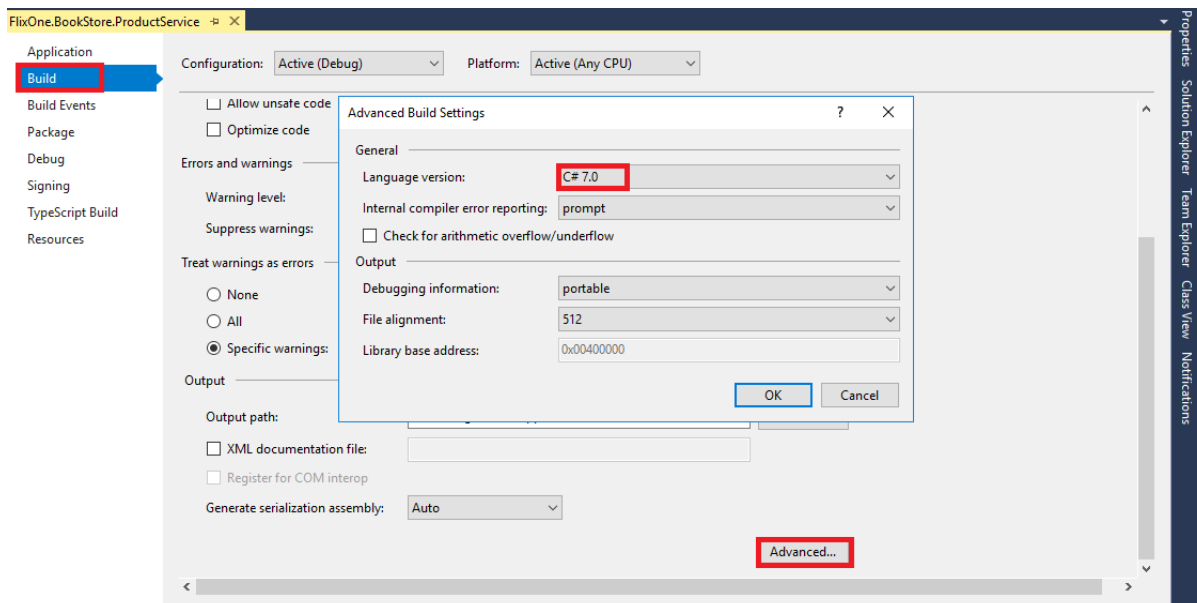
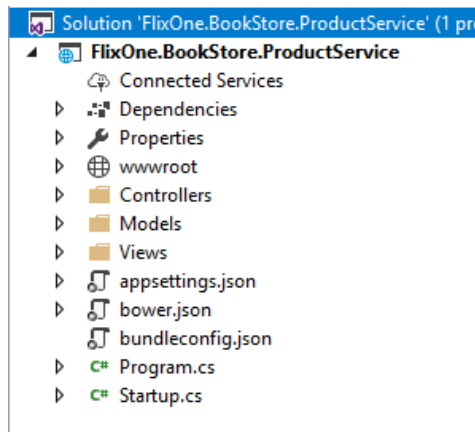
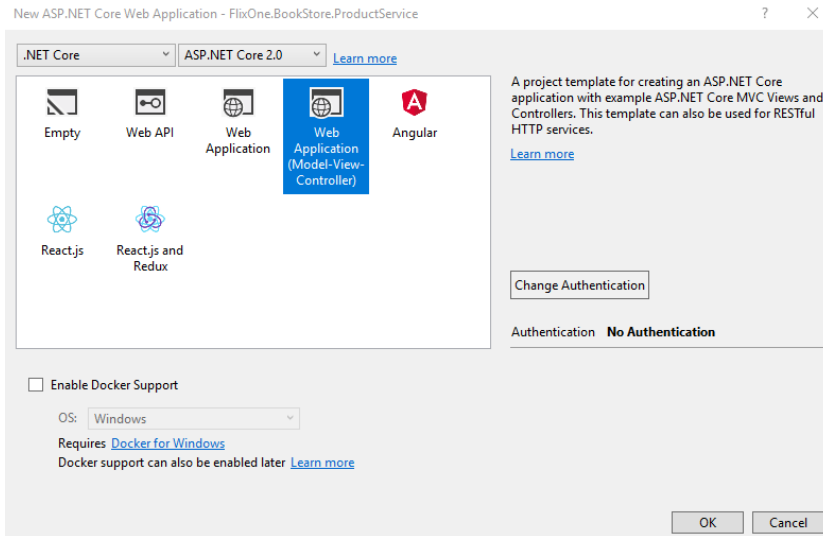

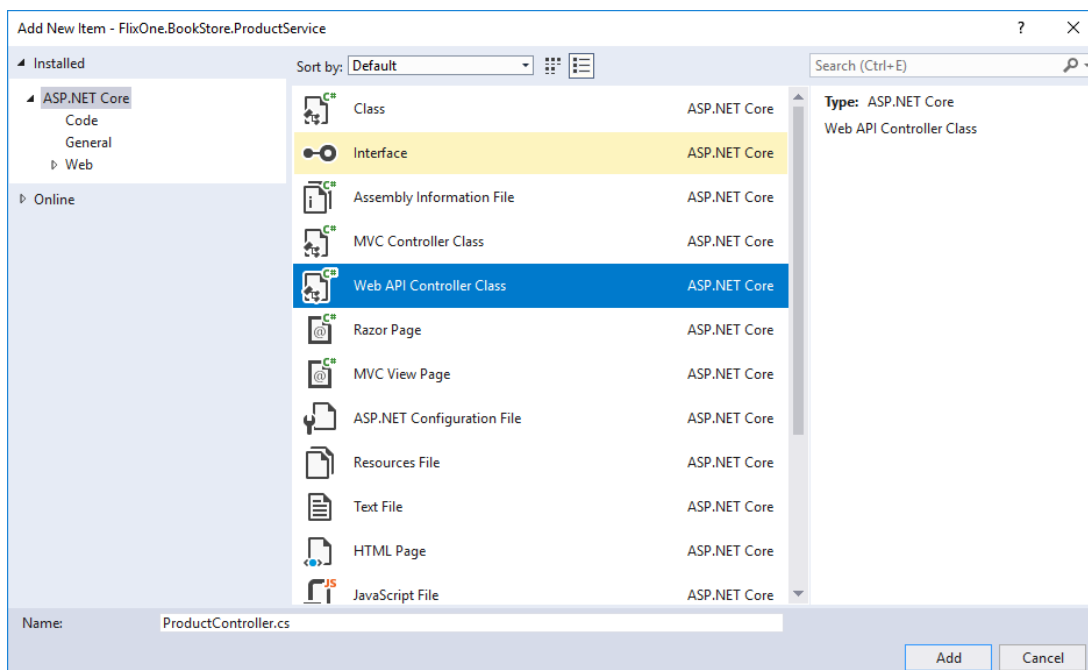
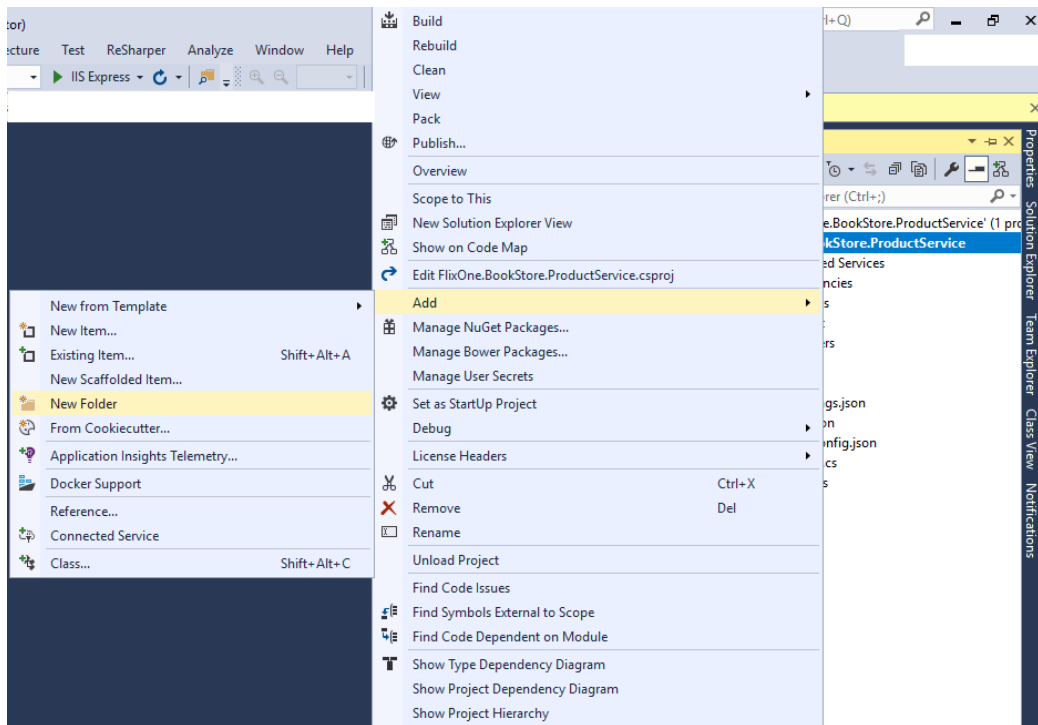

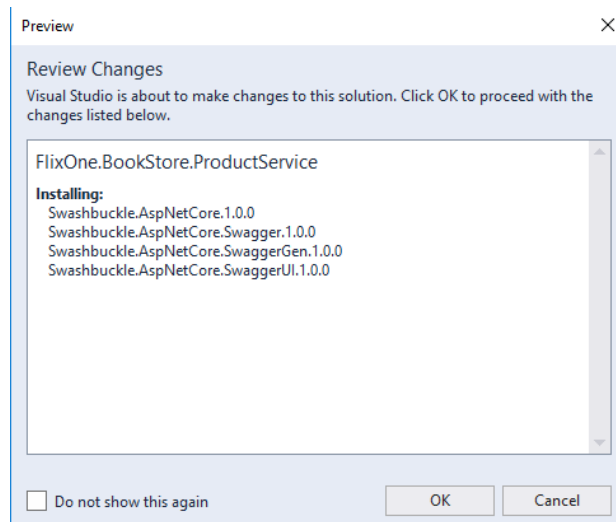
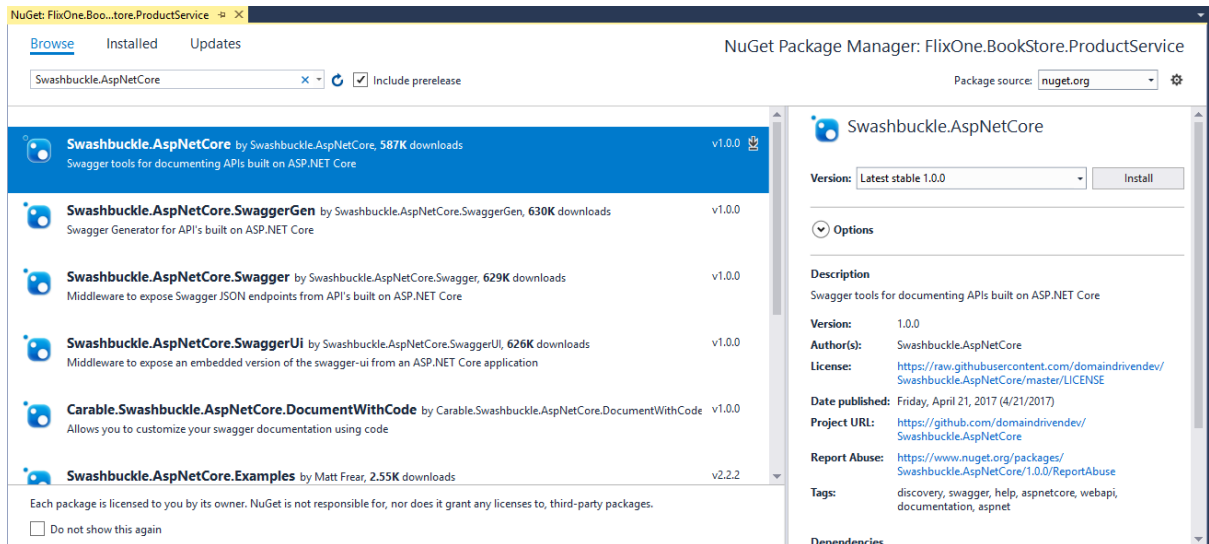
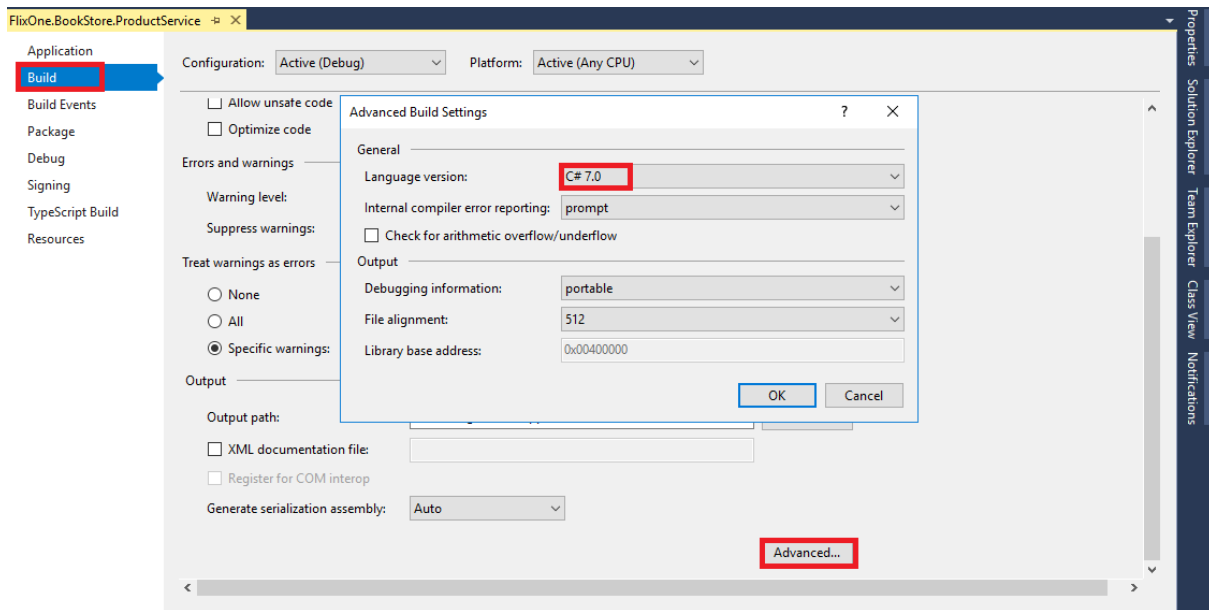

Product APIs

Product

[Show/Hide](#) | [List Operations](#) | [Expand Operations](#)

GET	/api/product/productlist
GET	/api/product/product/{productid}
POST	/api/product/addproduct
PUT	/api/product/updateproduct/{productid}
DELETE	/api/product/deleteproduct/{productid}

[BASE URL: / , API VERSION: v1]

Chapter 3: Integration Techniques and Microservices

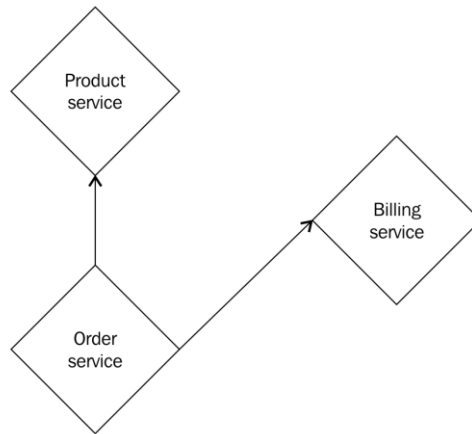

Rest API - Pictorial overview of sync communication

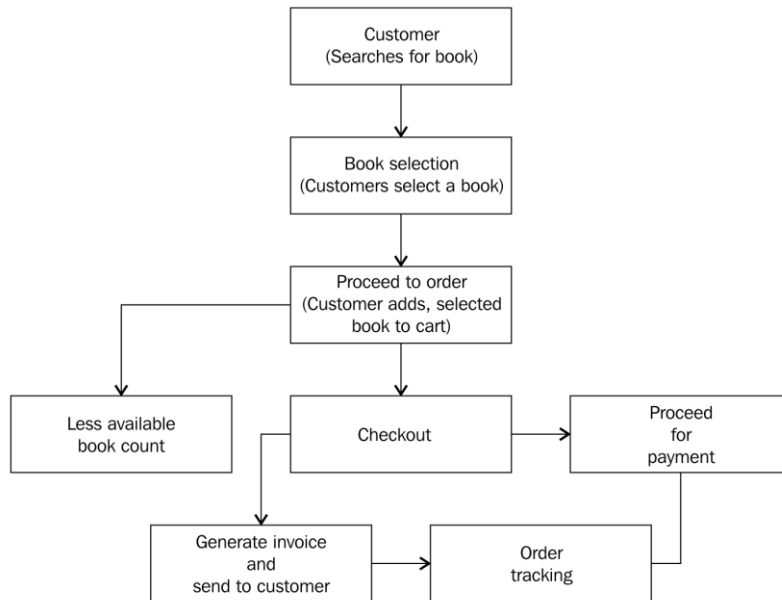

Pictorial view: Process of purchasing a book

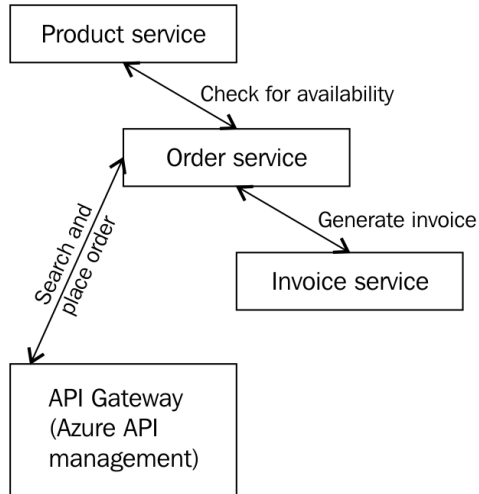

Pictorial overview: Inter-service communication for order process

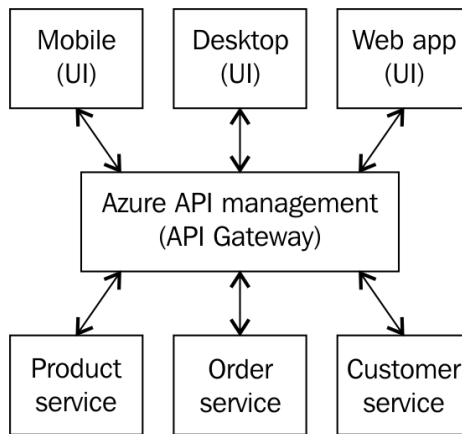

Pictorial overview: API Gateway

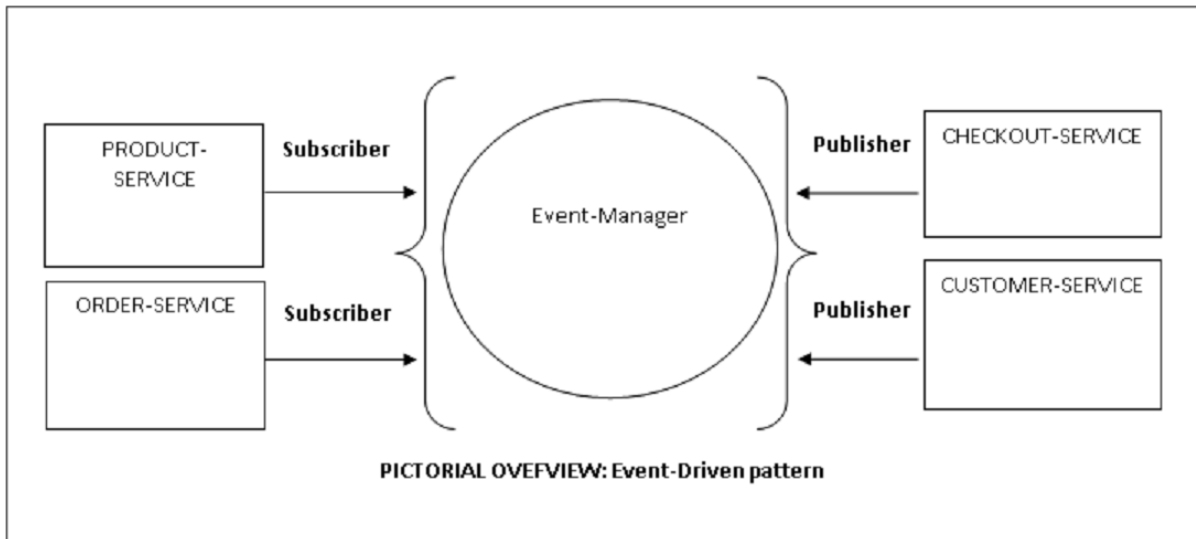

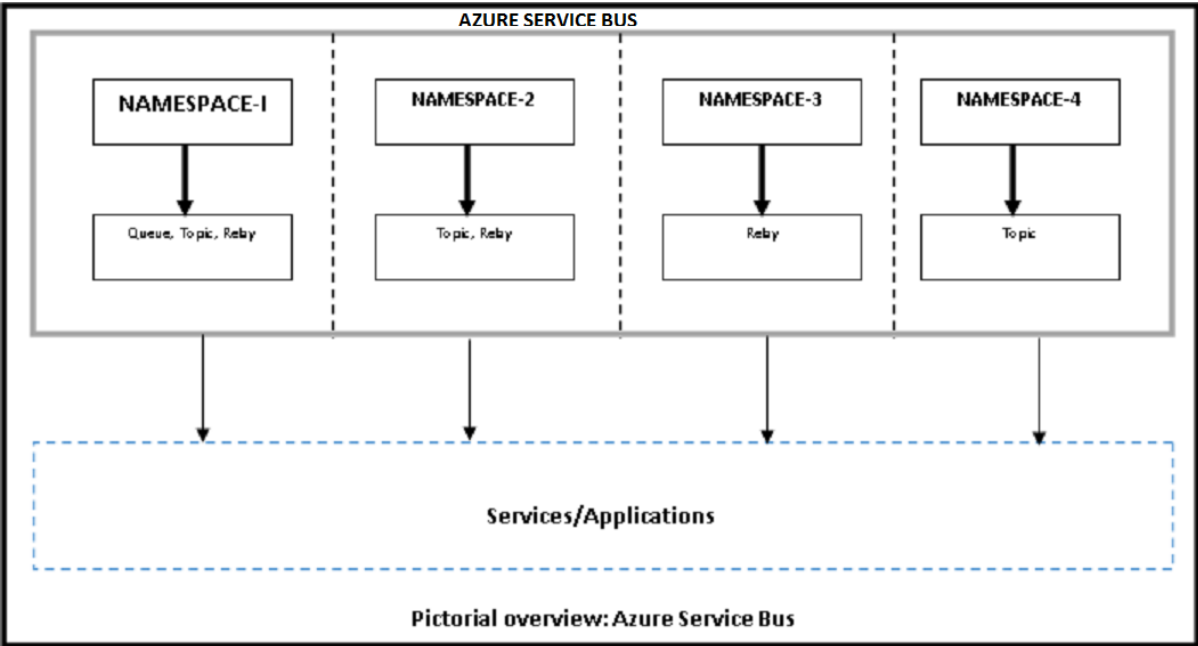
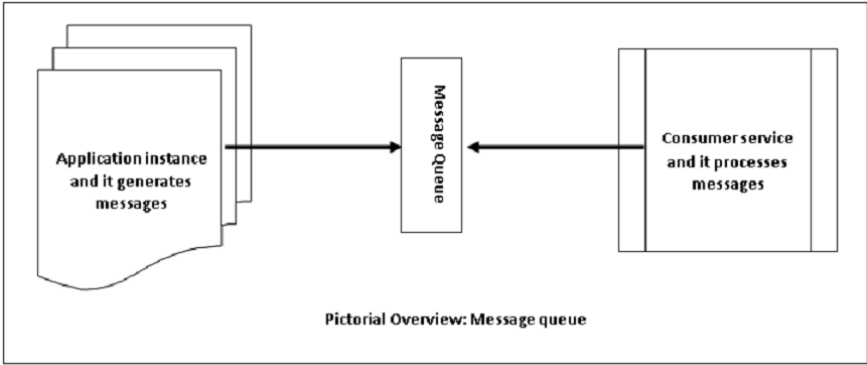
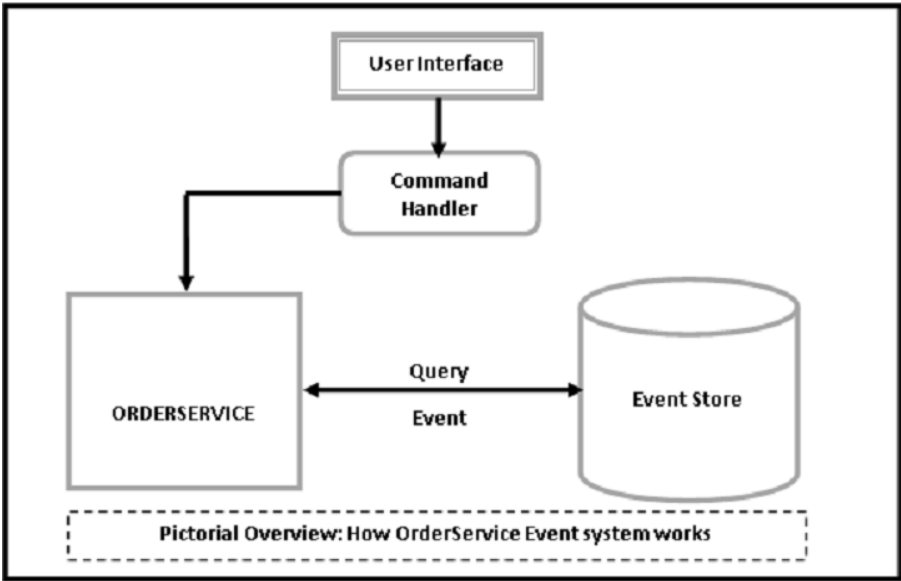

Create namespace

Service Bus

* Name
flixone ✓
.servicebus.windows.net

* Pricing tier
Standard >

* Subscription
[Redacted] v

* Resource group ⓘ
 Create new Use existing
flixonebookstore ✓

* Location
Southeast Asia v

Pin to dashboard

Create Automation options

flixone - Shared access policies

Service Bus

+ Add

Search (Ctrl+/)

- Access control (IAM)
- Tags
- Diagnose and solve problems

SETTINGS

- Shared access policies**
- Scale
- Properties
- Locks
- Automation script

ENTITIES

- Queues
- Topics

Shared access policies

Search to filter items...

POLICY	CLAIMS
RootManageSharedAccessKey	Manage, Send, Listen

flixone - Queues
Service Bus

Search (Ctrl+/)

✕ Diagnose and solve problems

SETTINGS

- 🔑 Shared access policies
- 📈 Scale
- 📄 Properties
- 🔒 Locks
- 📄 Automation script

ENTITIES

- 📄 Queues**
- 📄 Topics

Create queue
flixone

* Name
flixonequeue ✓

Max size
1 GB

Message time to live (default)
14 days

Lock duration
30 seconds

- Move expired messages to the dead-letter subqueue
- Enable duplicate detection
- Enable sessions
- Enable partitioning

Create

NuGet: FlixOne.Bo...tore.MessageSender Program.cs

Browse Installed Updates

Microsoft.Azure.ServiceBus Include prerelease Package source: nuget.org

Microsoft.Azure.ServiceBus by Microsoft, 41.4K downloads v1.0.0

This is the next generation Azure Service Bus .NET Standard client library that focuses on queues & topics. For more information about Service Bus, see https://azure.microsoft.com/en-us/services/service-bus/

Microsoft.Azure.ServiceBus
Version: Latest stable 1.0.0 Install

```

Starting...
Sending message: #0:A message from FlixOne.BookStore.MessageSender.
Sending message: #1:A message from FlixOne.BookStore.MessageSender.
Sending message: #2:A message from FlixOne.BookStore.MessageSender.
Sending message: #3:A message from FlixOne.BookStore.MessageSender.
Sending message: #4:A message from FlixOne.BookStore.MessageSender.
Sending message: #5:A message from FlixOne.BookStore.MessageSender.
Sending message: #6:A message from FlixOne.BookStore.MessageSender.
Sending message: #7:A message from FlixOne.BookStore.MessageSender.
Sending message: #8:A message from FlixOne.BookStore.MessageSender.
Sending message: #9:A message from FlixOne.BookStore.MessageSender.
Ending...
Press any key...

```

The screenshot shows the Azure Service Bus portal for a queue named 'floxonequeue'. The interface includes a search bar, navigation tabs for 'Overview', 'Diagnose and solve problems', 'SETTINGS', and 'SUPPORT + TROUBLESHOOTING'. The 'Overview' tab is active, displaying the following metrics:

- ACTIVE MESSAGE COUNT: 10 MESSAGES
- SCHEDULED MESSAGE COUNT: 0 MESSAGES
- DEAD-LETTER MESSAGE COUNT: 0 MESSAGES
- TRANSFER MESSAGE COUNT: 0 MESSAGES
- TRANSFER DEAD-LETTER MESSAGE COUNT: 0 MESSAGES
- MAX SIZE: 16 GB
- CURRENT: 2.1 KB
- 100% FREE SPACE (indicated by a donut chart)

The Queue URL is <https://floxone.servicebus.windows.net/floxonequeue>.

The screenshot shows the NuGet Package Manager interface for the package 'Microsoft.Extensions.Configuration'. The package is highlighted in blue. The version selected is 'Latest stable 2.0.0'. The package source is set to 'nuget.org'. The package description is: 'Implementation of key-value pair based configuration for Microsoft.Extensions.Configuration. Includes the memory configuration provider.'

The screenshot shows the NuGet Package Manager interface for the package 'Microsoft.Extensions.Configuration.Json'. The package is highlighted in blue. The version selected is '2.0.0'. The package source is set to 'nuget.org'. The package description is: 'JSON configuration provider implementation for Microsoft.Extensions.Configuration.'

```
Starting...
Sending message: #0:A message from FlixOne.BookStore.MessageSender.
Sending message: #1:A message from FlixOne.BookStore.MessageSender.
Sending message: #2:A message from FlixOne.BookStore.MessageSender.
Sending message: #3:A message from FlixOne.BookStore.MessageSender.
Sending message: #4:A message from FlixOne.BookStore.MessageSender.
Sending message: #5:A message from FlixOne.BookStore.MessageSender.
Sending message: #6:A message from FlixOne.BookStore.MessageSender.
Sending message: #7:A message from FlixOne.BookStore.MessageSender.
Sending message: #8:A message from FlixOne.BookStore.MessageSender.
Sending message: #9:A message from FlixOne.BookStore.MessageSender.
Ending...
Press any key...
```

flixonequeue
Service Bus

Delete

Search (Ctrl+)

Overview

Diagnose and solve problems

SETTINGS

- Shared access policies
- Properties
- Locks
- Automation script

SUPPORT + TROUBLESHOOTING

- New support request

Essentials

Namespace: flixone Queue URL: <https://flixone.servicebus.windows.net/flixo...>

ACTIVE MESSAGE COUNT	0 MESSAGES	MAX SIZE	16 GB
SCHEDULED MESSAGE COUNT	0 MESSAGES	CURRENT	0.0 KB
DEAD-LETTER MESSAGE COUNT	0 MESSAGES		
TRANSFER MESSAGE COUNT	0 MESSAGES		
TRANSFER DEAD-LETTER MESSAGE COUNT	0 MESSAGES		

Chapter 4: Testing Microservices

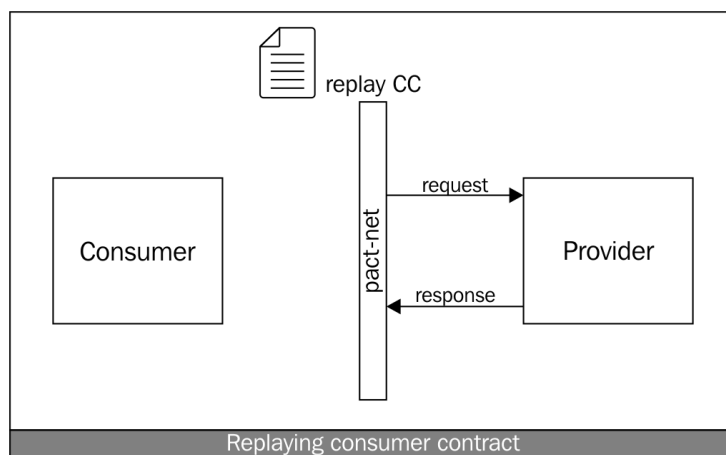
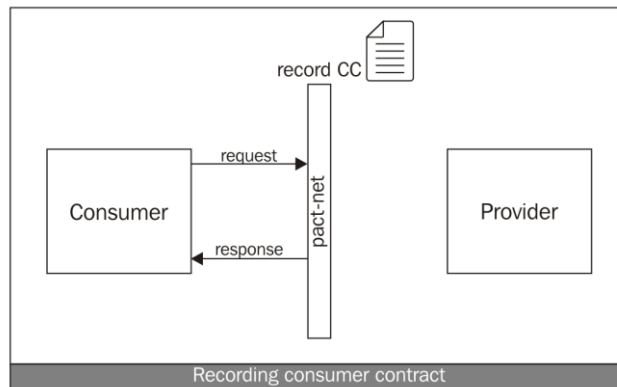
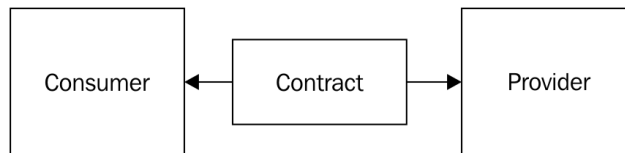
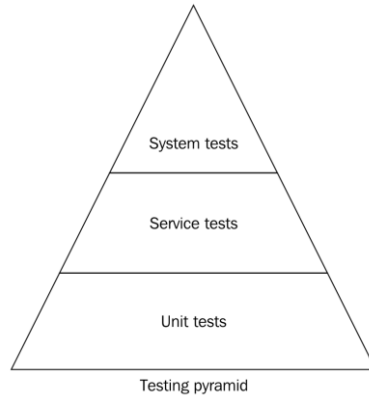

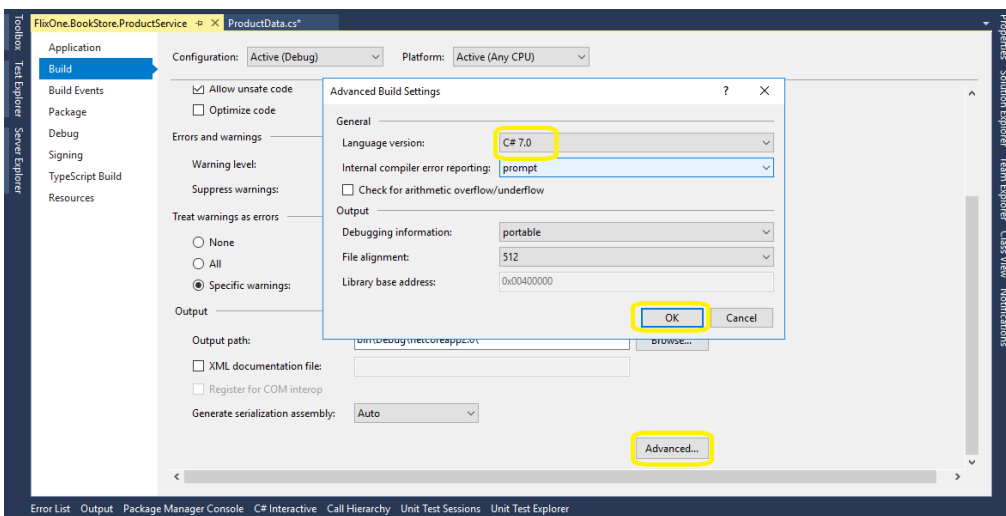
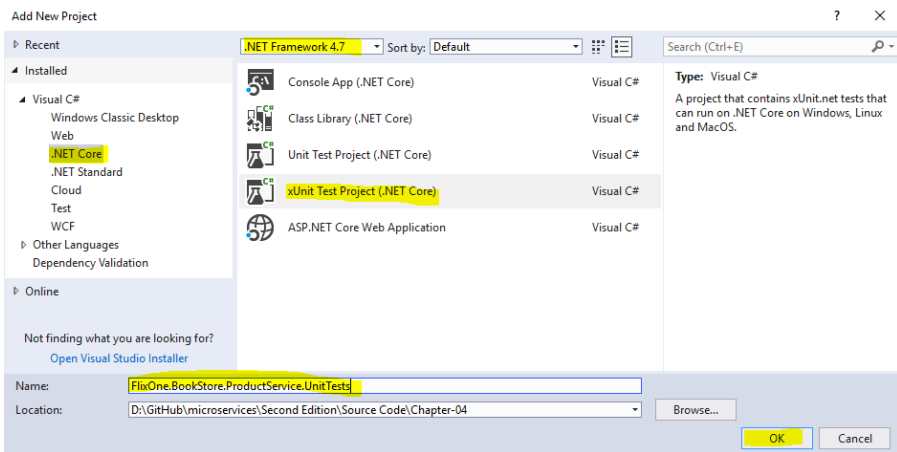
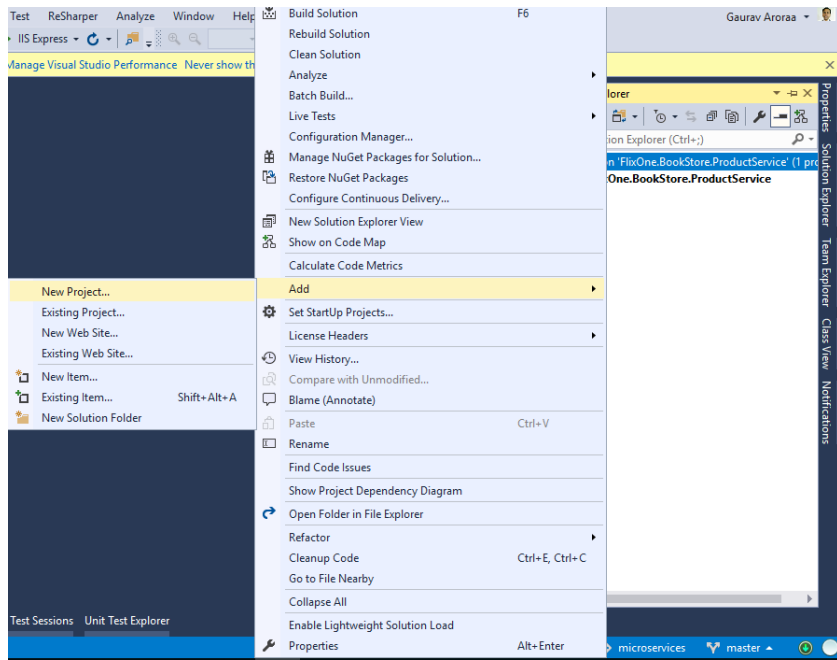

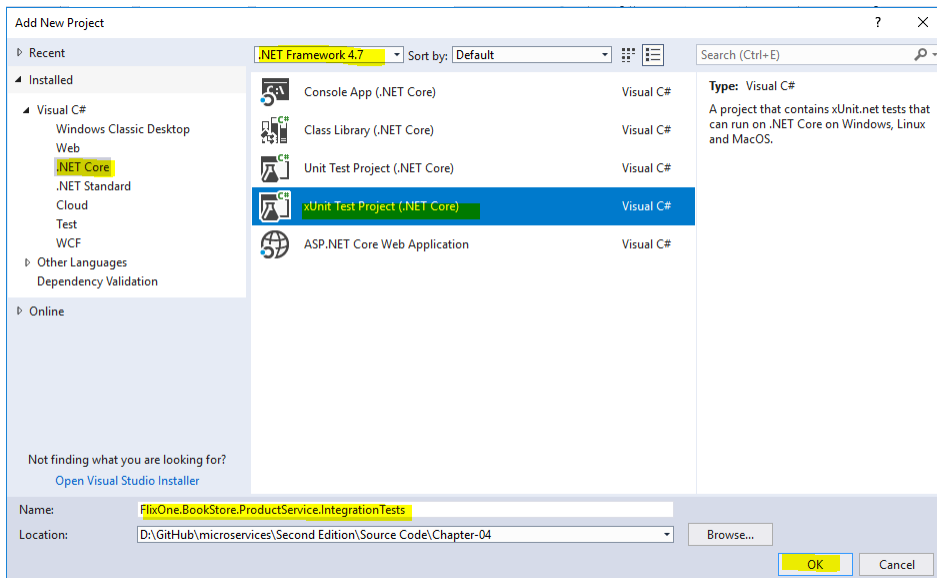
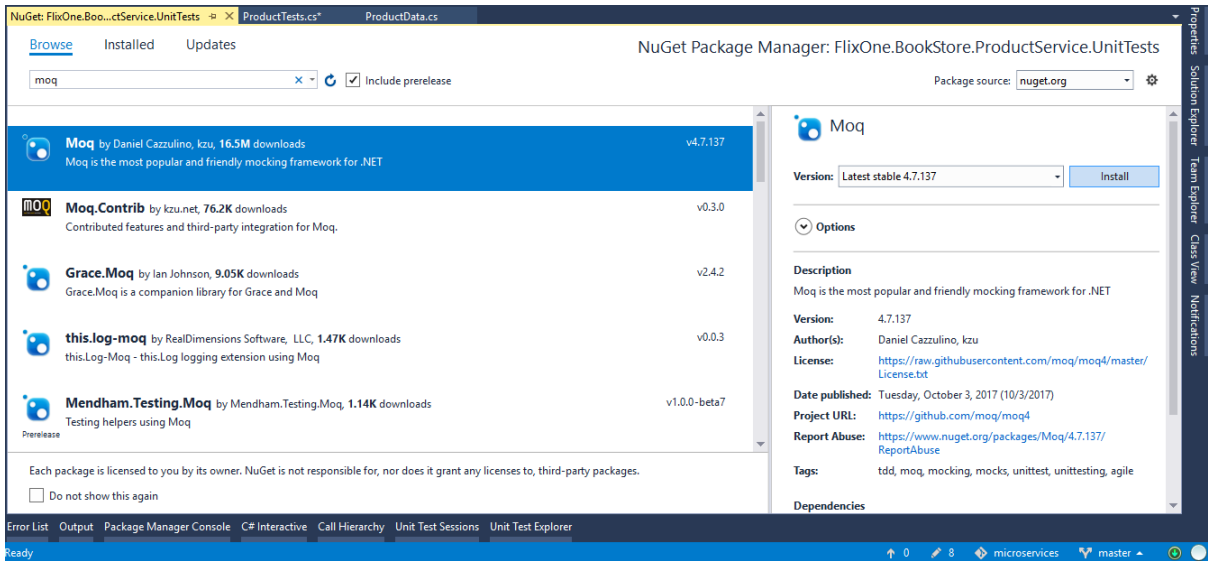
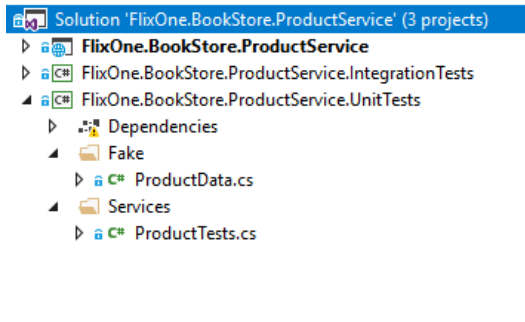

NuGet: FlixOne.Boo...ce.IntegrationTests ProductTest.cs

Browse Installed Updates 3

Microsoft.AspNetCore.TestHost x Include prerelease Package source: nuget.org

Microsoft.AspNetCore.TestHost by Microsoft, 842K downloads v2.0.0
ASP.NET Core web server for writing and running tests.

Each package is licensed to you by its owner. NuGet is not responsible for, nor does it grant any licenses to, third-party packages.
 Do not show this again

Microsoft.AspNetCore.TestHost

Version: Latest stable 2.0.0 Install

Options

Description
ASP.NET Core web server for writing and running tests.

Version: 2.0.0
Author(s): Microsoft
License: <https://raw.githubusercontent.com/aspnet/Home/2.0.0/LICENSE.txt>
Date published: Friday, August 11, 2017 (8/11/2017)
Project URL: <https://asp.net/>
Report Abuse: <https://www.nuget.org/packages/Microsoft.AspNetCore.TestHost/2.0.0/ReportAbuse>
Tags: hosting, testing, aspnetcore

Dependencies

Error List Output Package Manager Console C# Interactive Call Hierarchy Unit Test Sessions Unit Test Explorer

Diagnostics Tools Properties Solution Explorer Team Explorer Class View Notifications

Chapter 5: Deploying Microservices

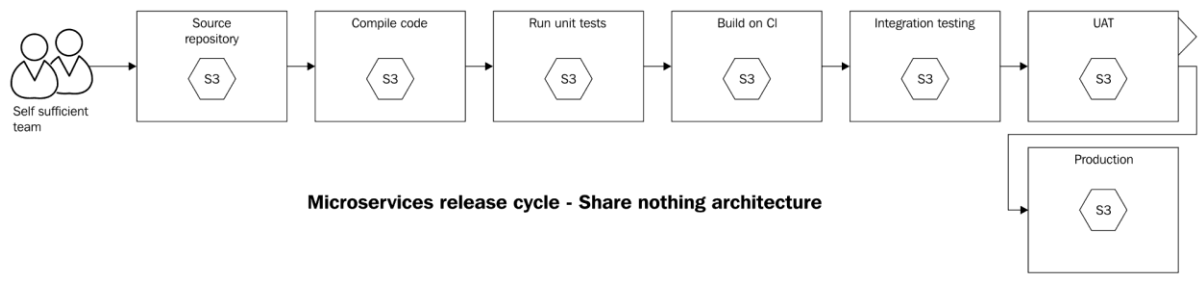
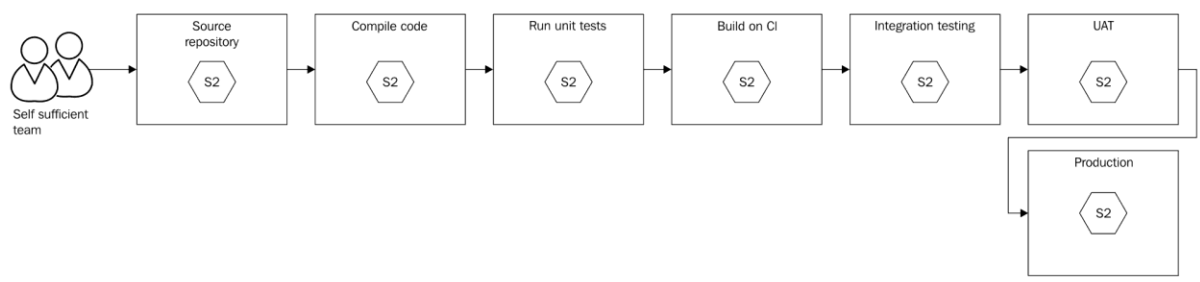
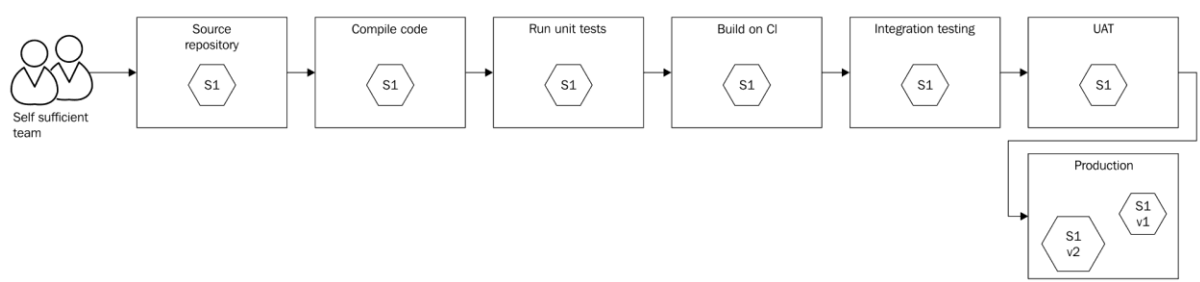
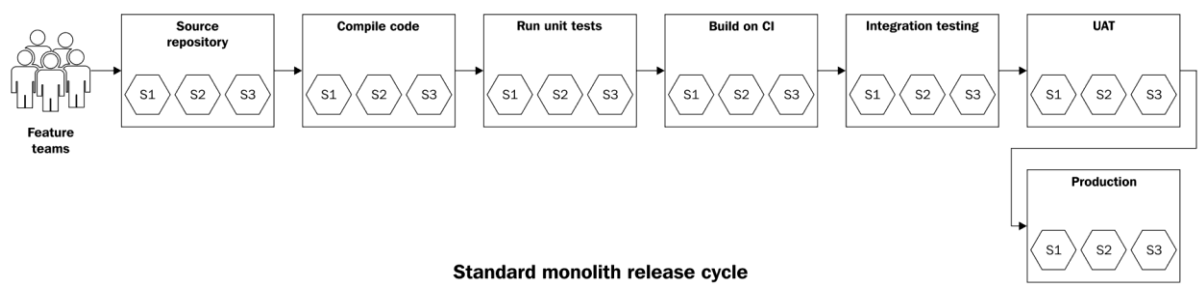

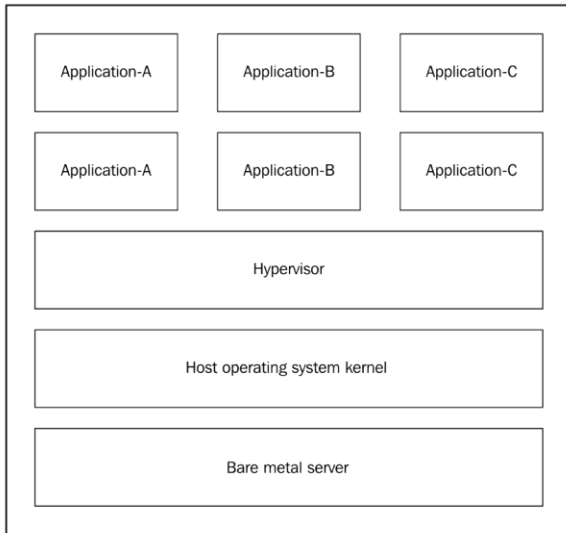

Virtual machine

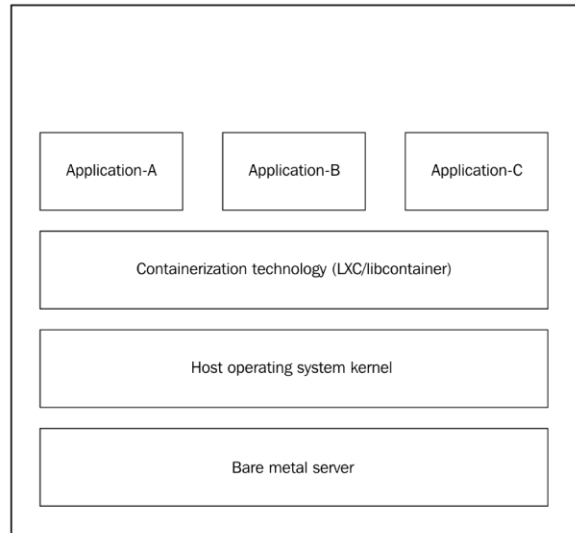

Container

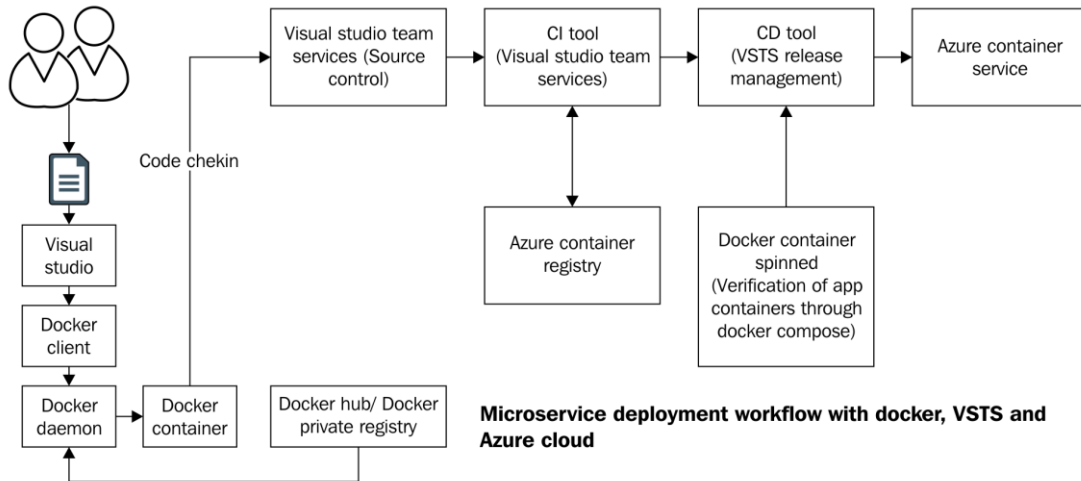

Microservice deployment workflow with docker, VSTS and Azure cloud

Docker for Windows



Hyper-V feature is not enabled.
Do you want to enable it for Docker to be able to work properly?
Your computer will restart automatically.

Ok

Cancel

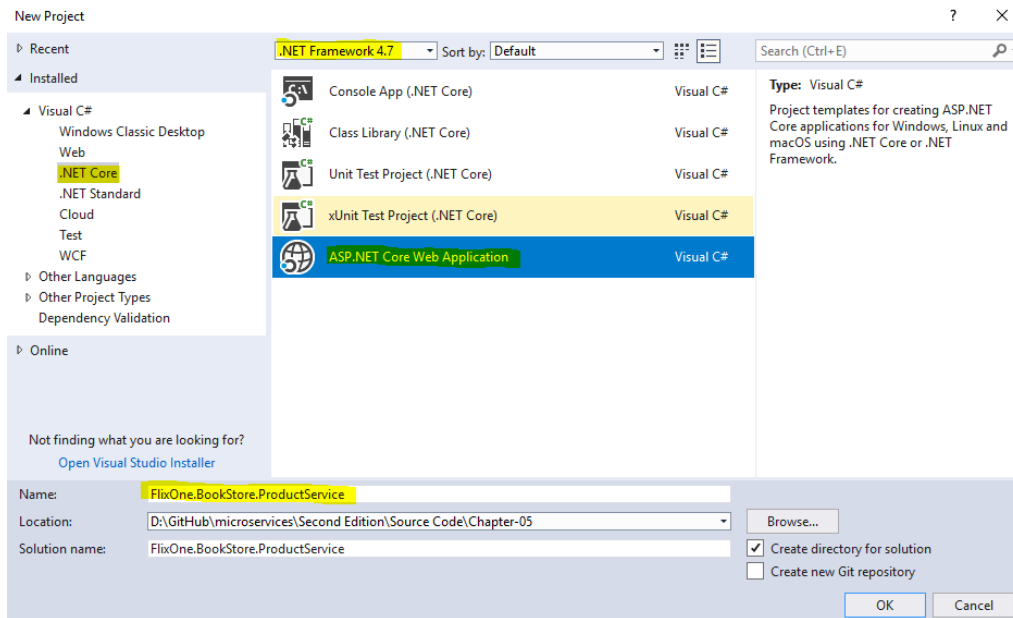
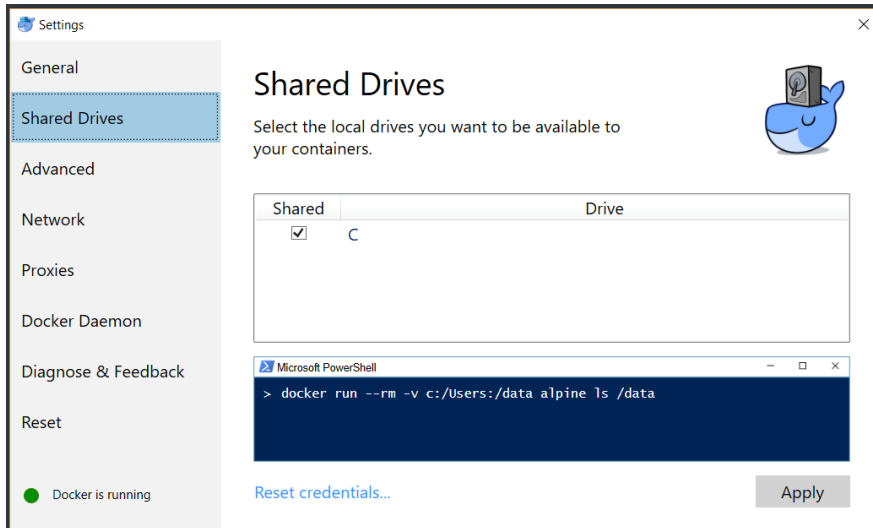

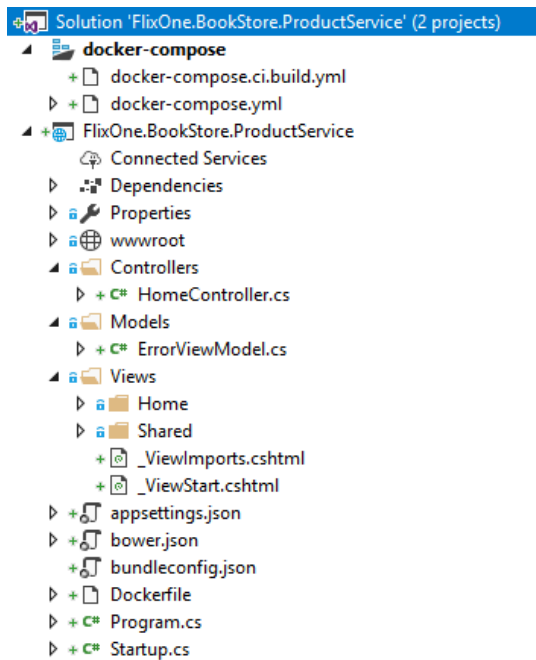
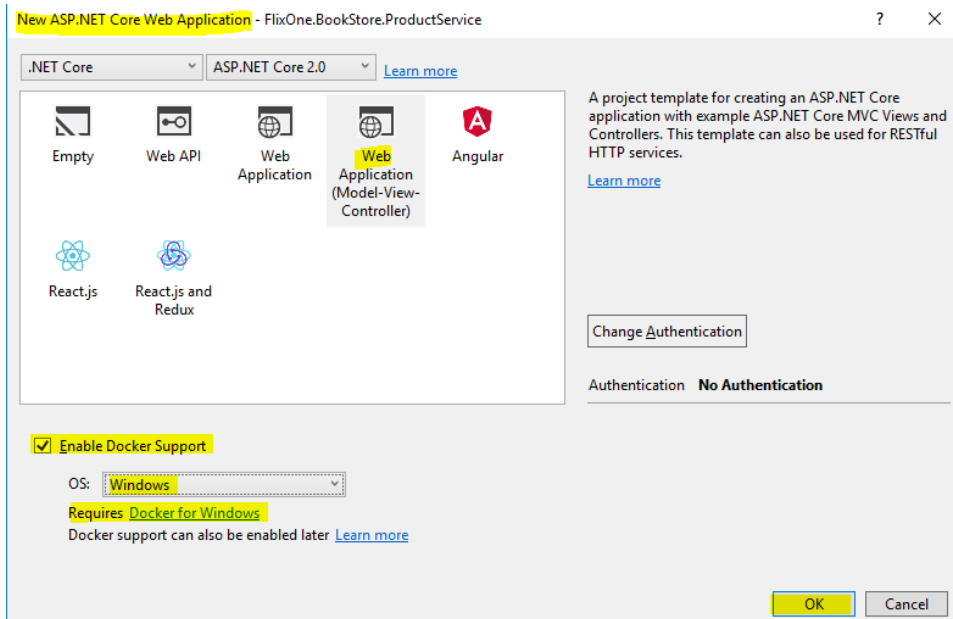

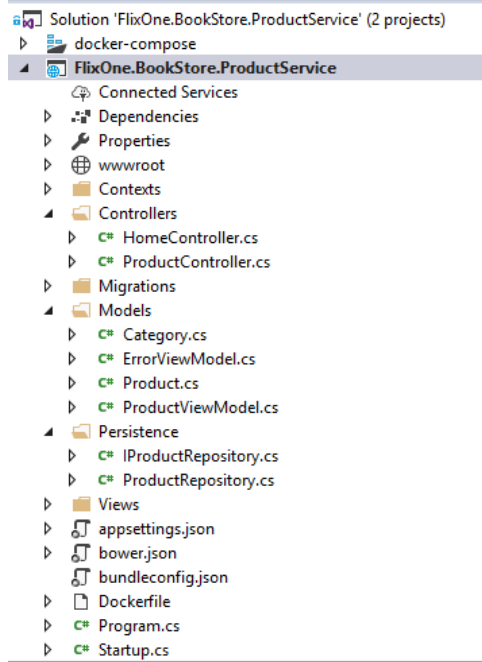

Chapter 6: Securing Microservices

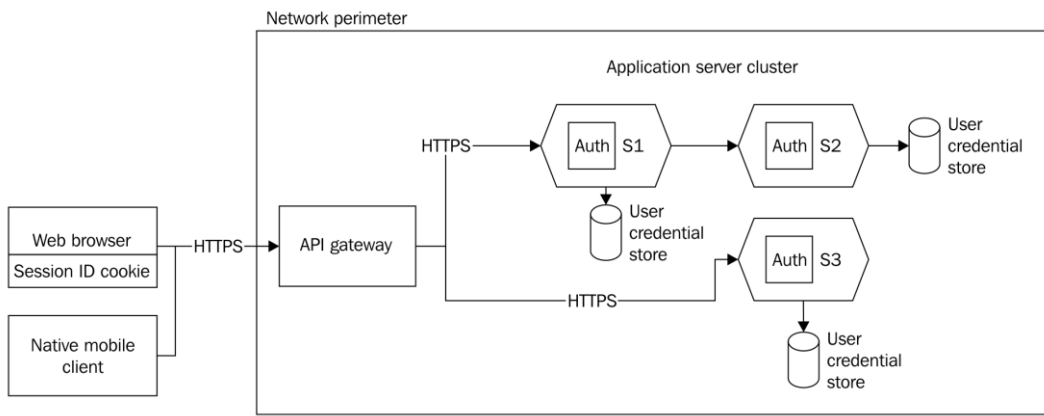
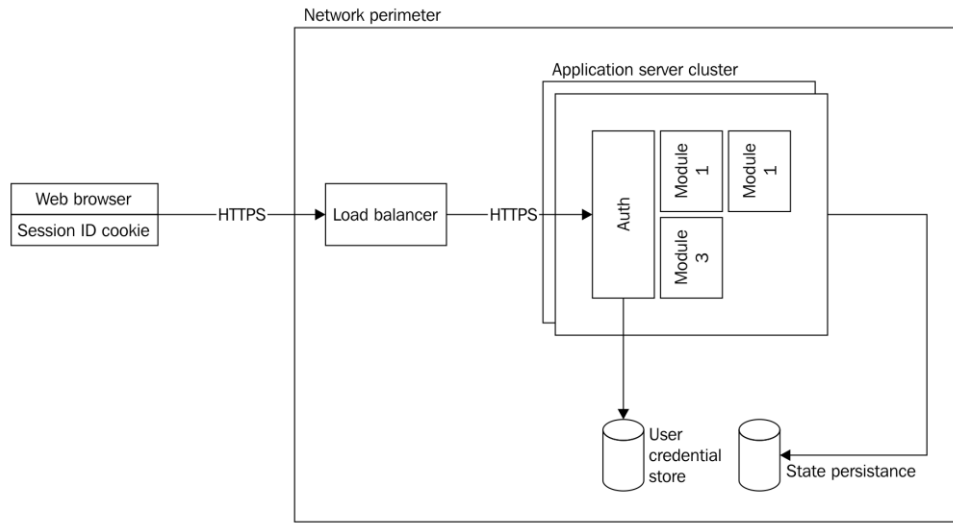

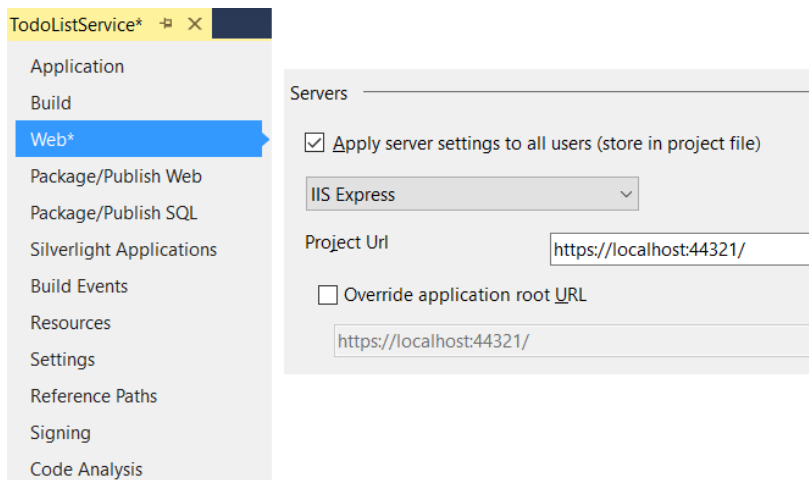
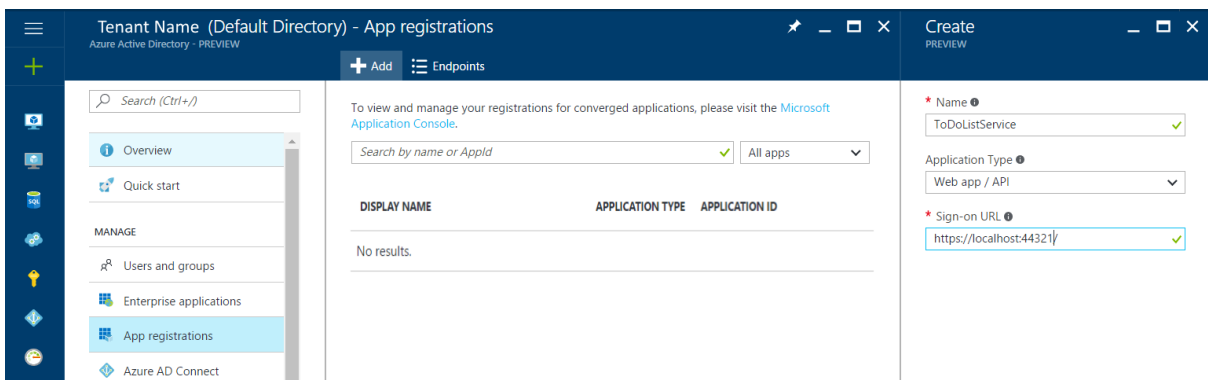
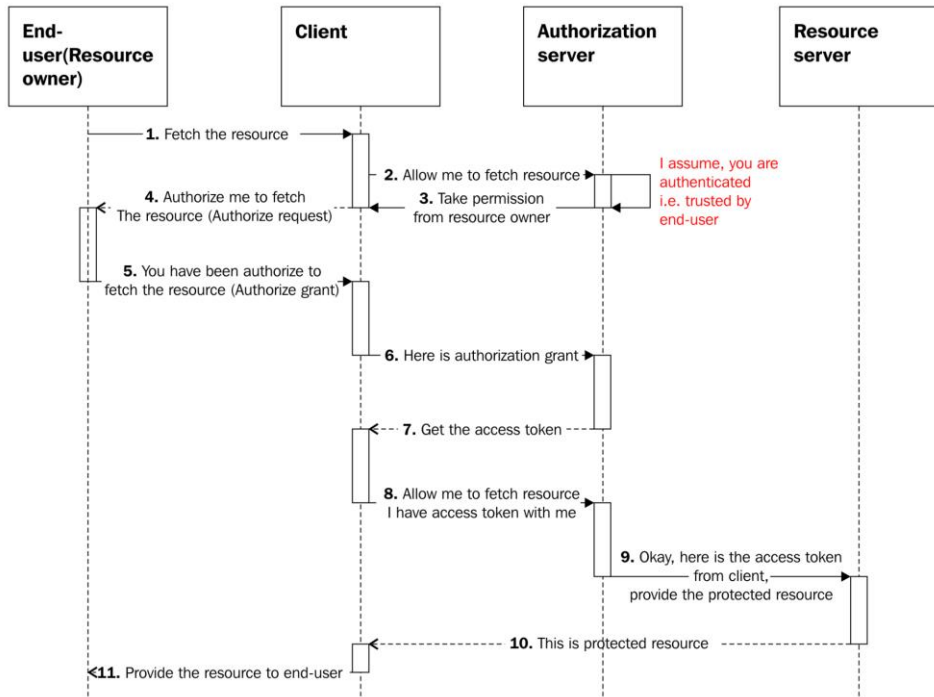

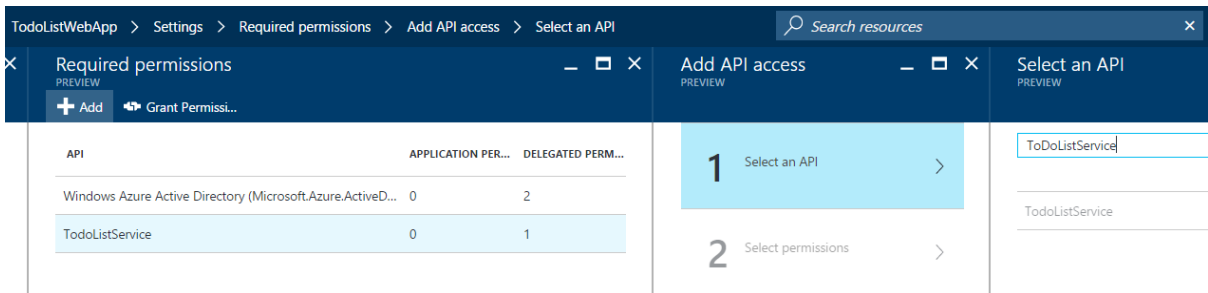
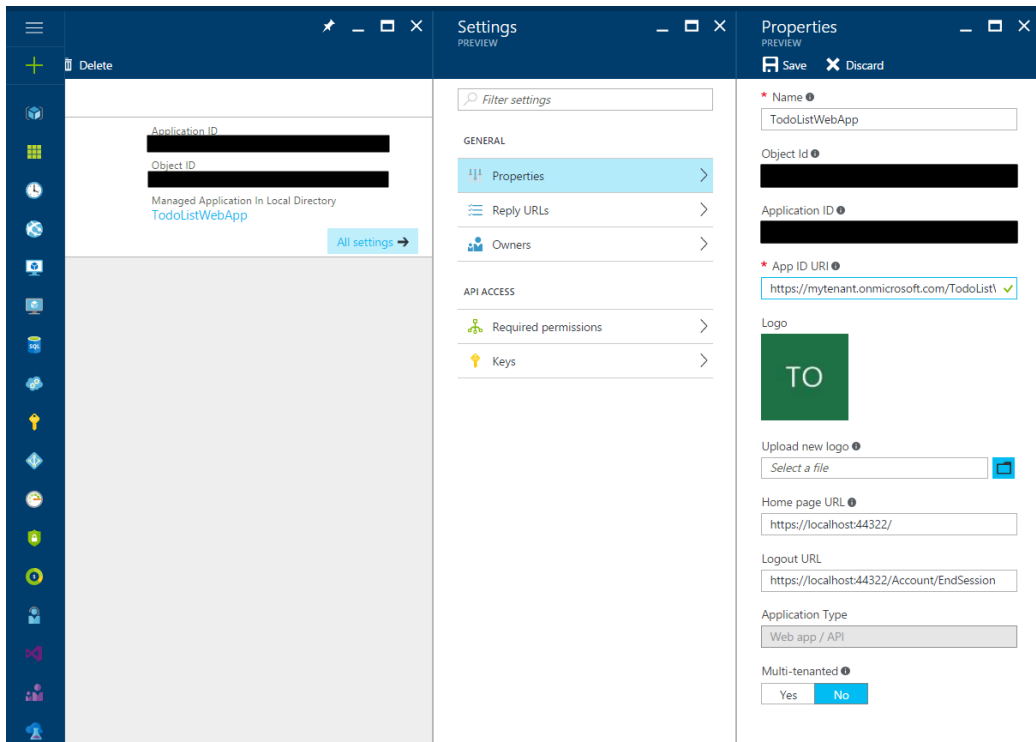
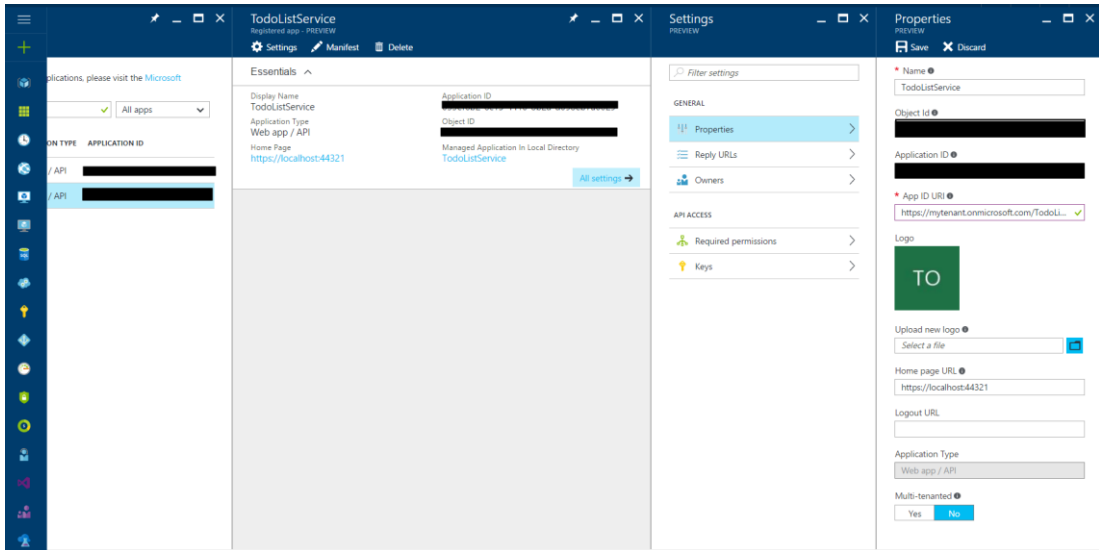

Settings PREVIEW
Keys PREVIEW

Save
Discard

GENERAL

- Properties >
- Reply URLs >
- Owners >

API ACCESS

- Required permissions >
- Keys >

DESCRIPTION	EXPIRES	VALUE	
AppKey	12/27/2017	Hidden	...
<input style="width: 80%;" type="text" value="Key description"/>	<input style="width: 20%;" type="text" value="Duration"/>	<input style="width: 80%;" type="text" value="Value will be displayed on save"/>	...

ASP.NET

ASP.NET is a free web framework for building great Web sites and Web applications using HTML, CSS and JavaScript.

[Learn more »](#)

Getting started

ASP.NET MVC gives you a powerful, patterns-based way to build dynamic websites that enables a clean separation of concerns and gives you full control over markup for enjoyable, agile development.

[Learn more »](#)

Get more libraries

NuGet is a free Visual Studio extension that makes it easy to add, remove, and update libraries and tools in Visual Studio projects.

[Learn more »](#)

Web Hosting

You can easily find a web hosting company that offers the right mix of features and price for your applications.

[Learn more »](#)

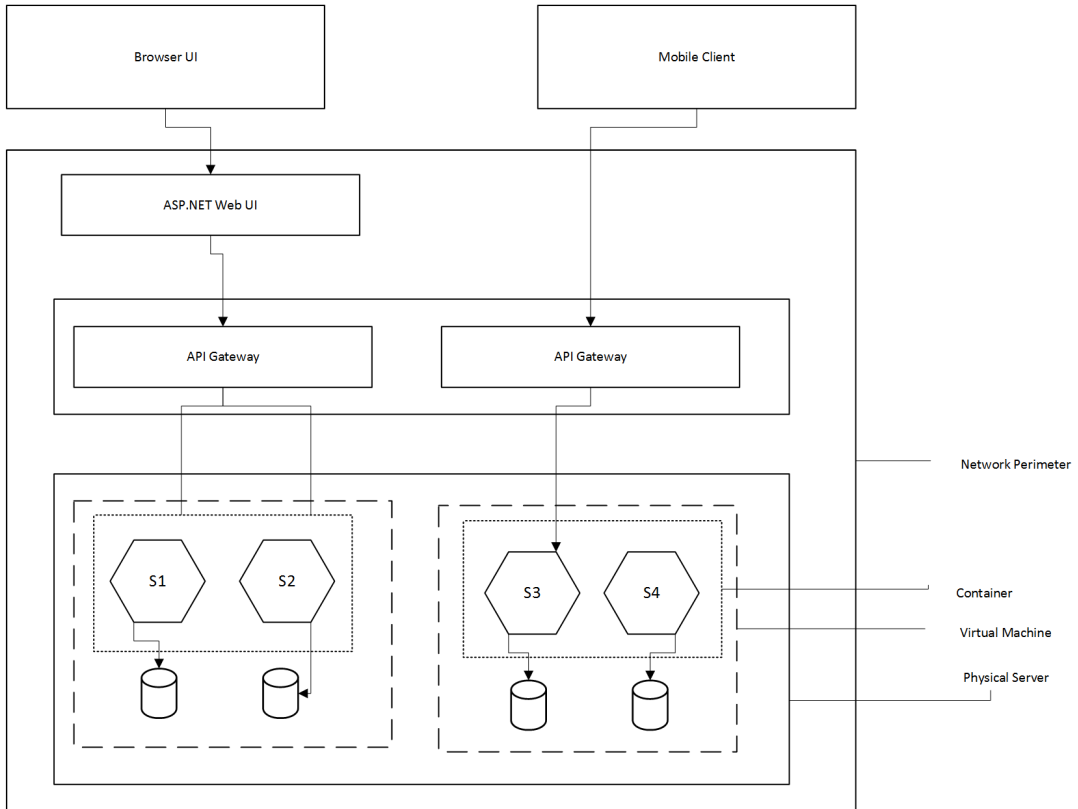

Chapter 7: Monitoring Microservices

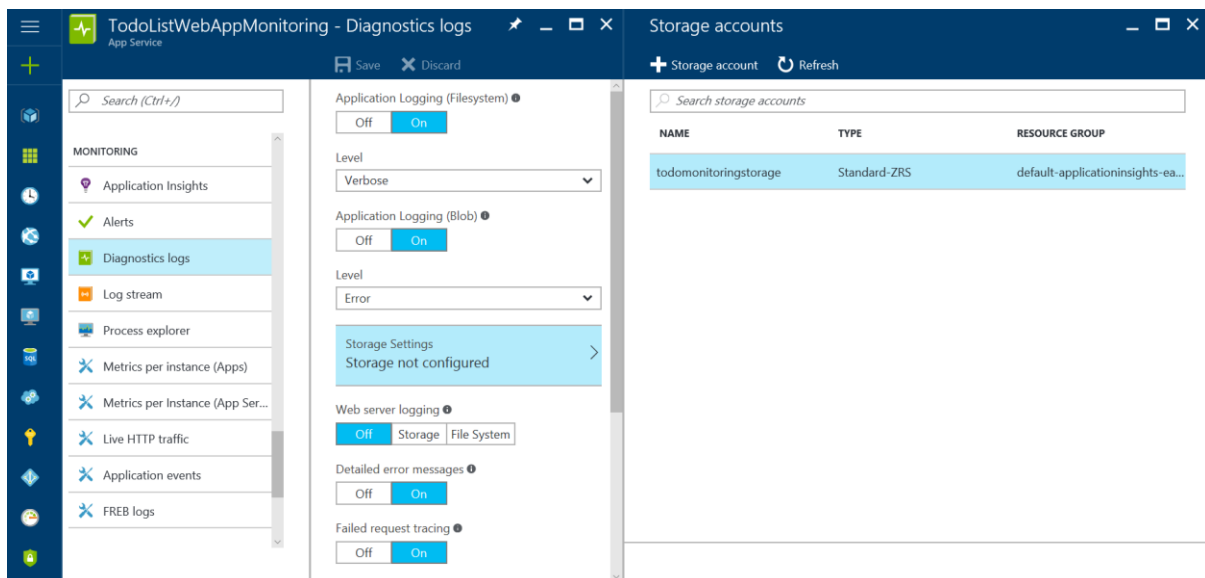
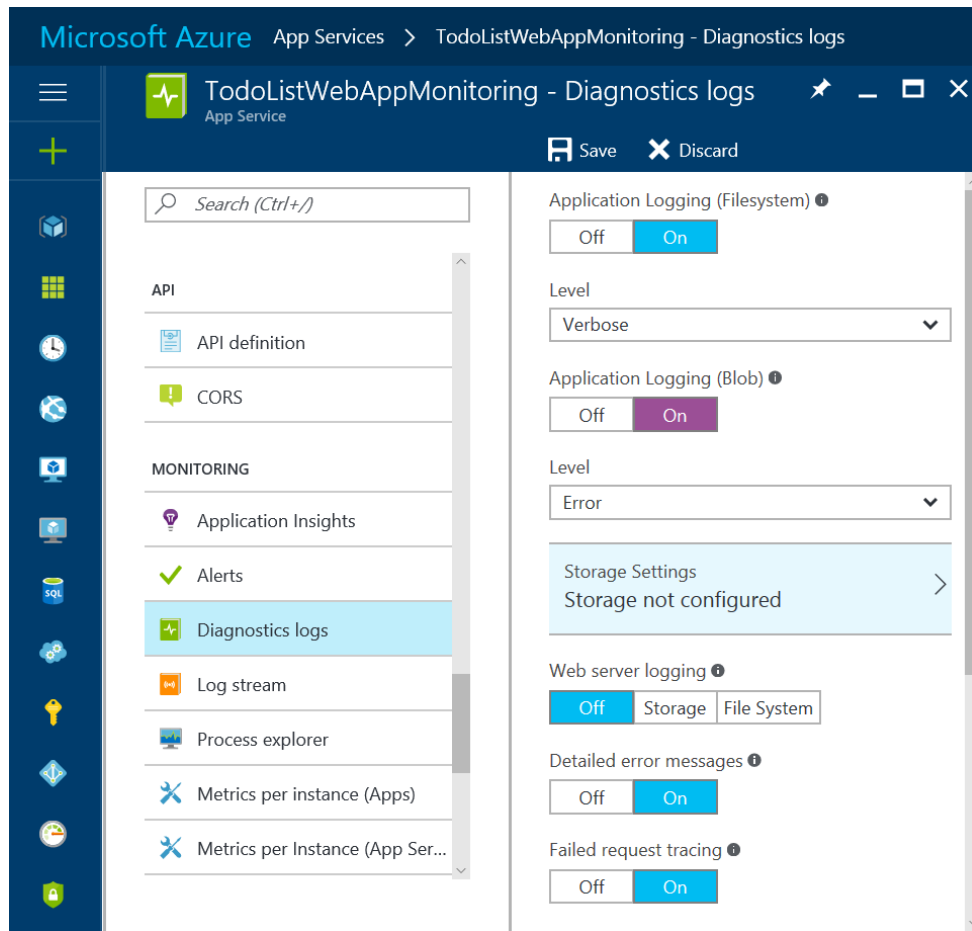

Chapter 8: Scaling Microservices

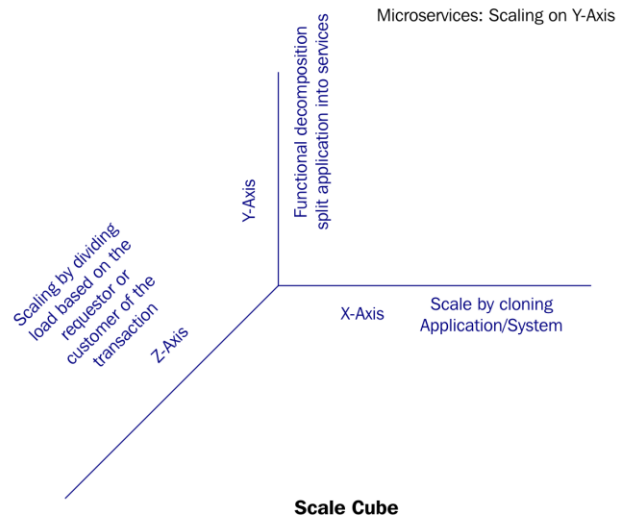

Ref: "The Art of Scalability: Scalable Web Architecture, Processes, and Organizations for the Modern Enterprise", Second Edition
Martin L. Abbott; Michael T. Fisher

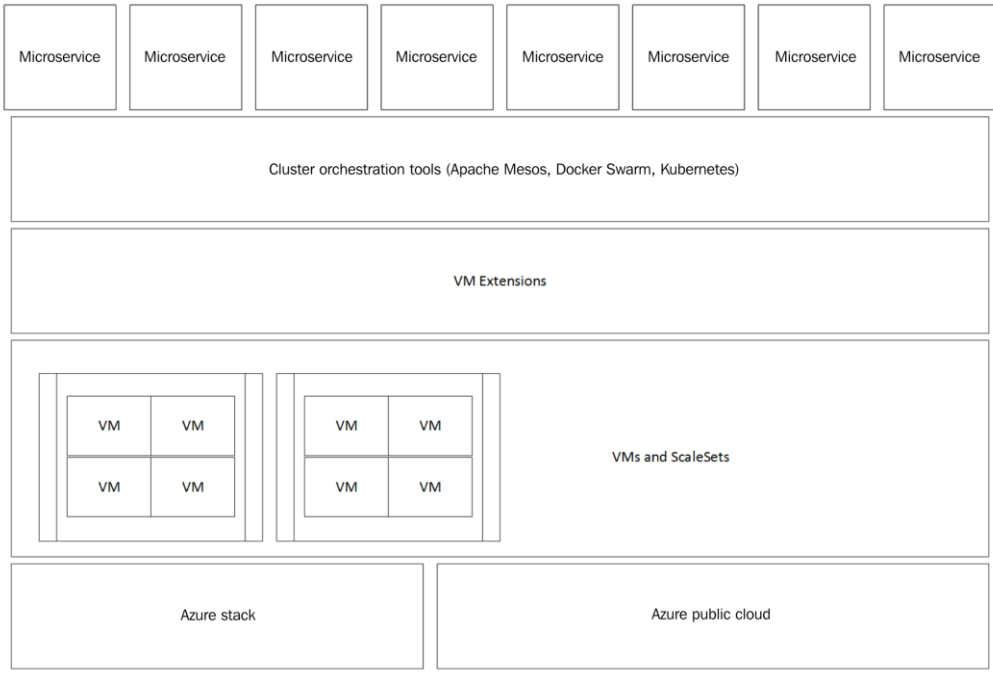

Microservices infrastructure

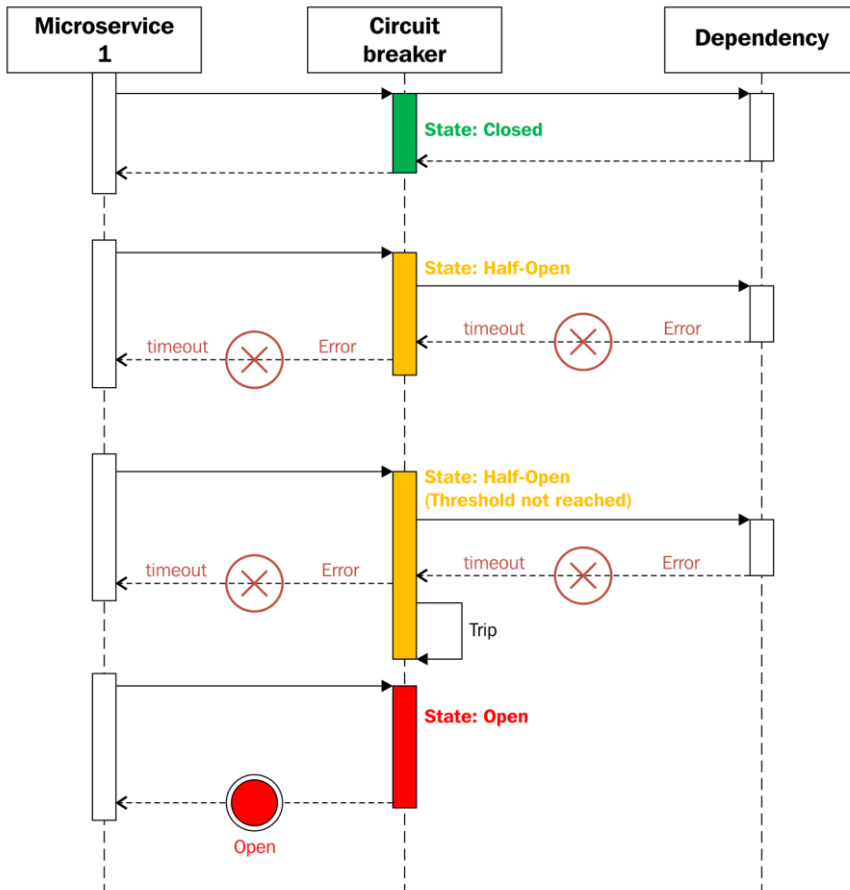

Chapter 9: Introduction to Reactive Microservices

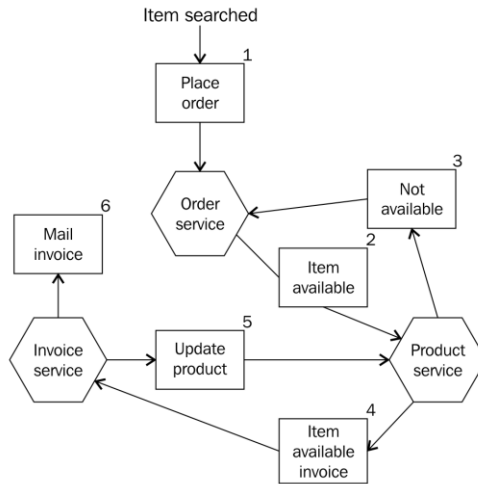

Event	Function
Login	Auth/Login
UpdateProduct	Product/Update

UpdateProduct += {BaseURL}/Product/Update

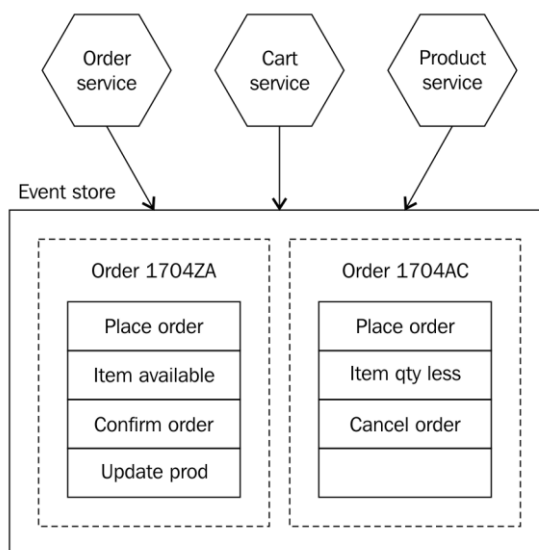
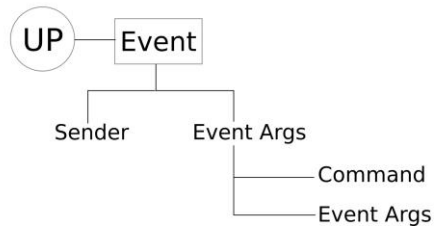

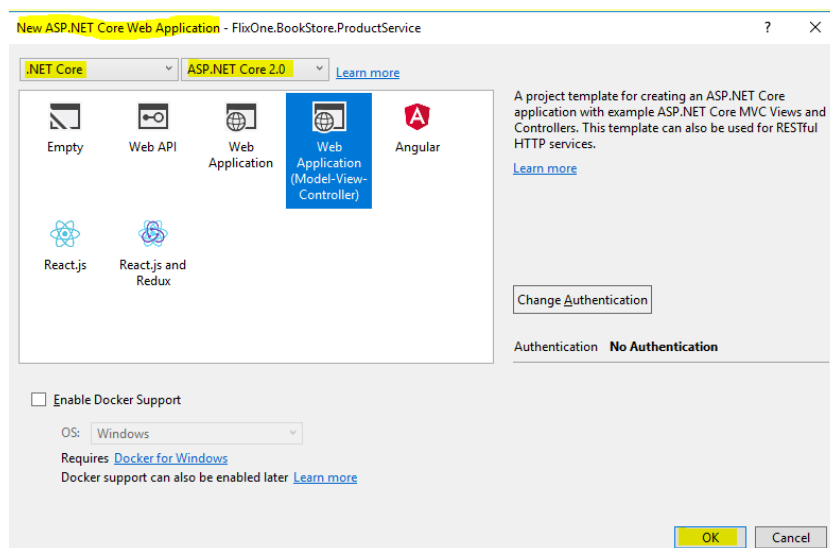
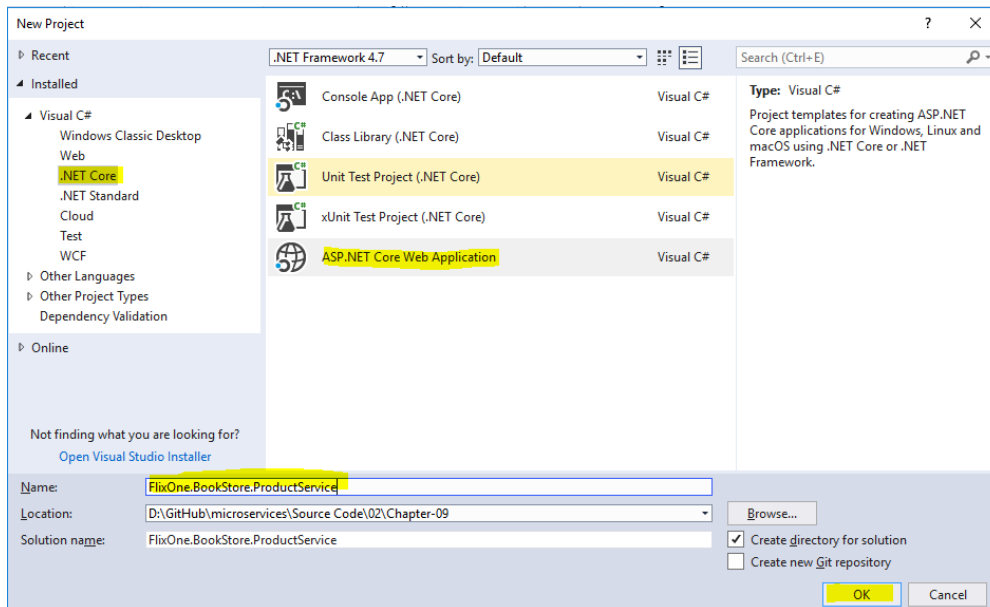
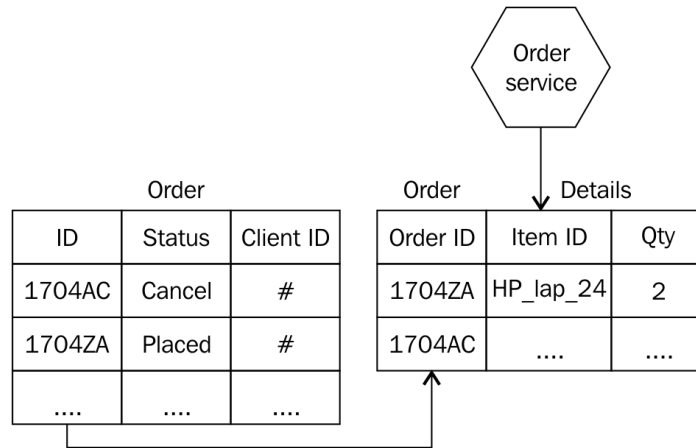

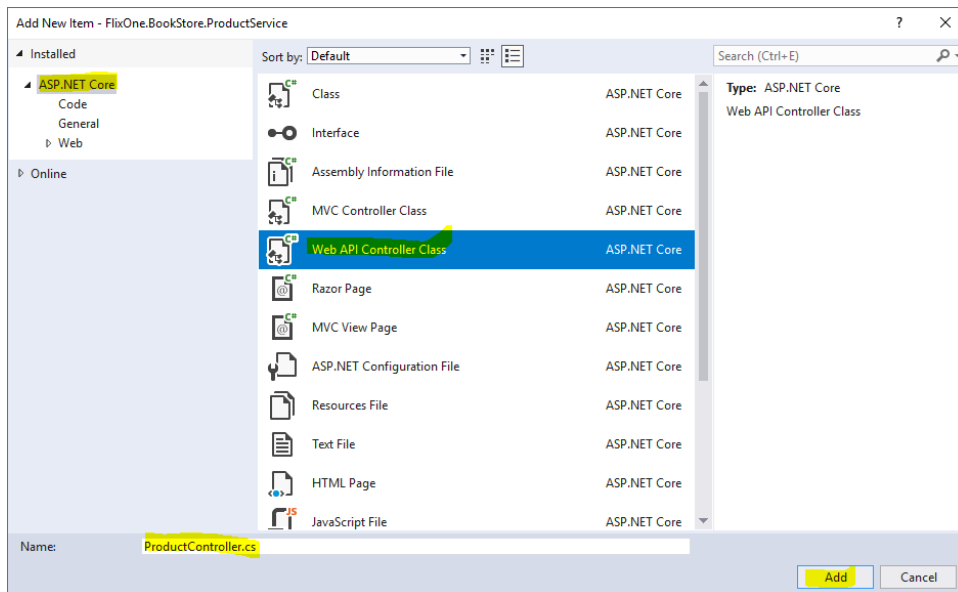
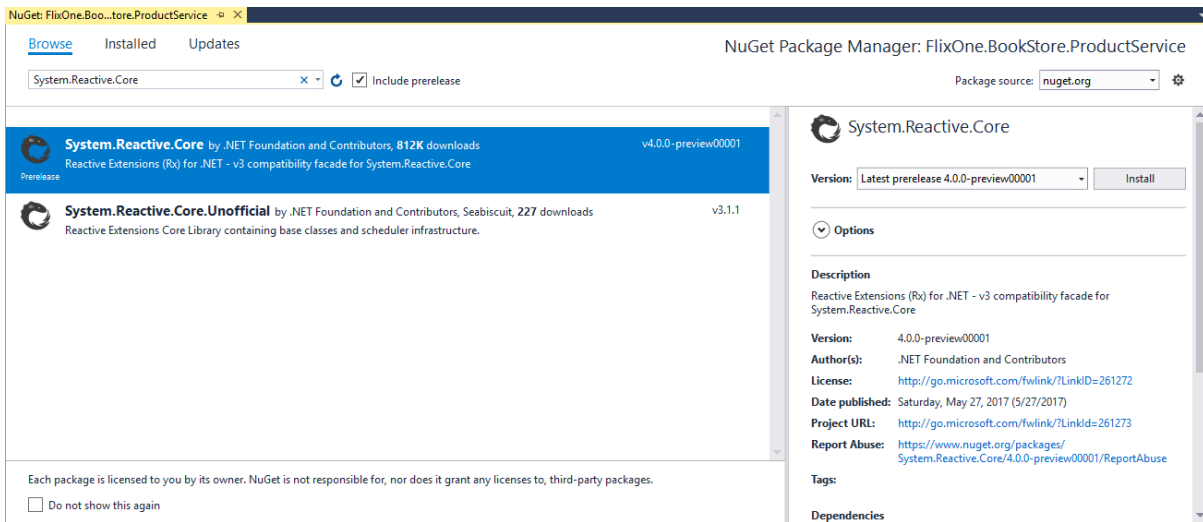
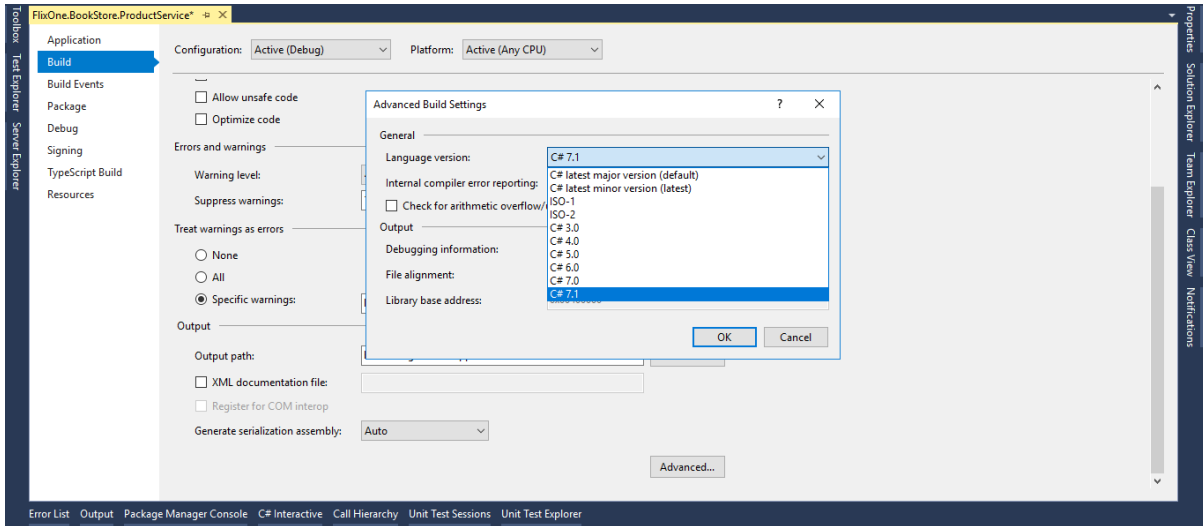

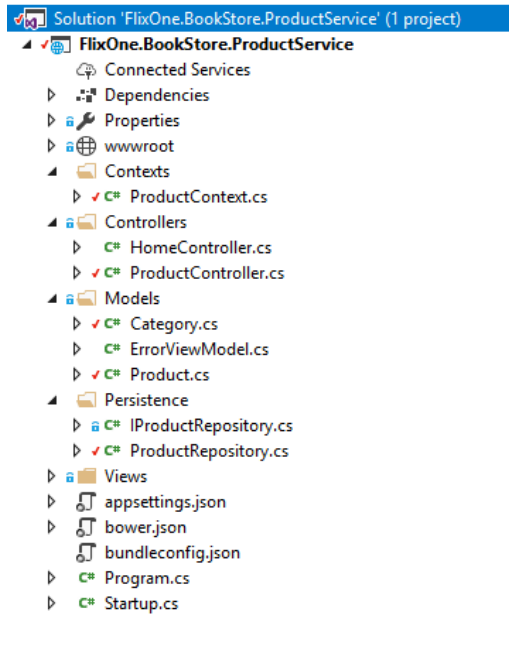

Chapter 10: Creating a Complete Microservice Solution

