

# Chapter 1: Thinking about Design Requirements

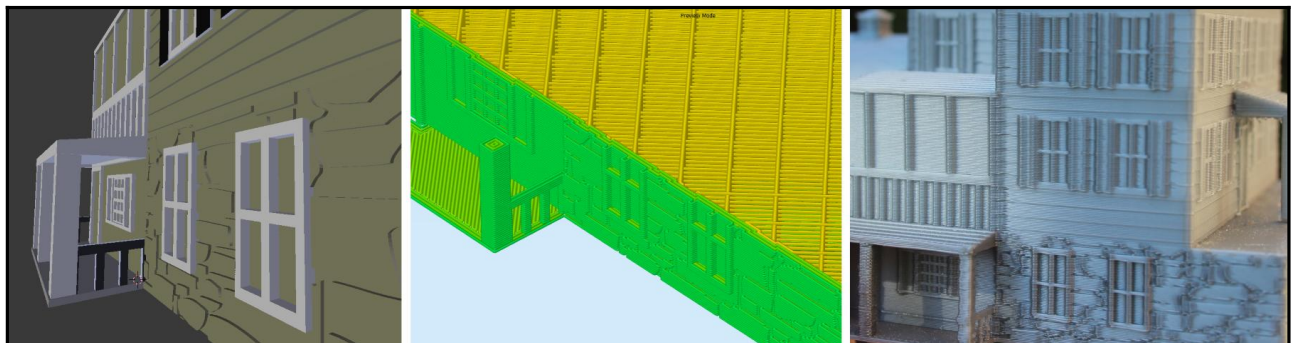

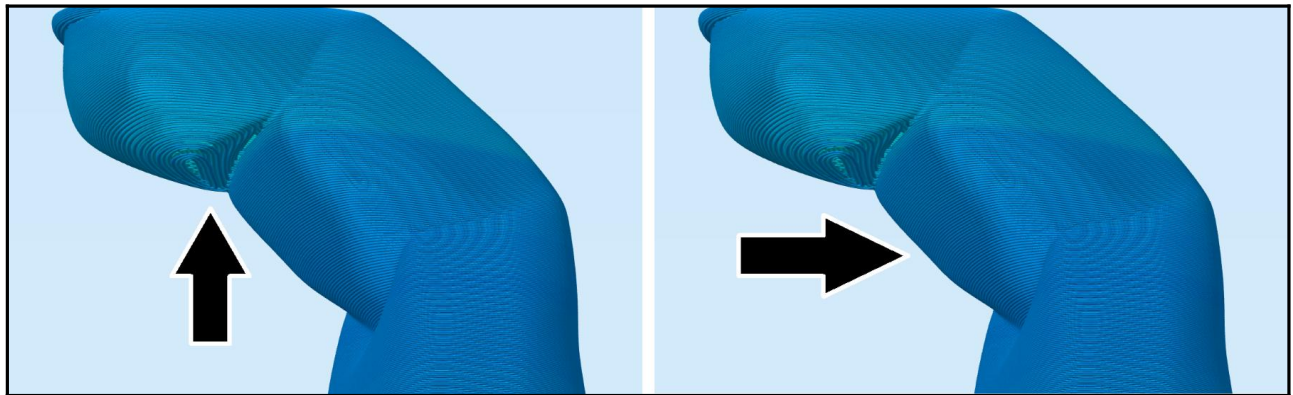

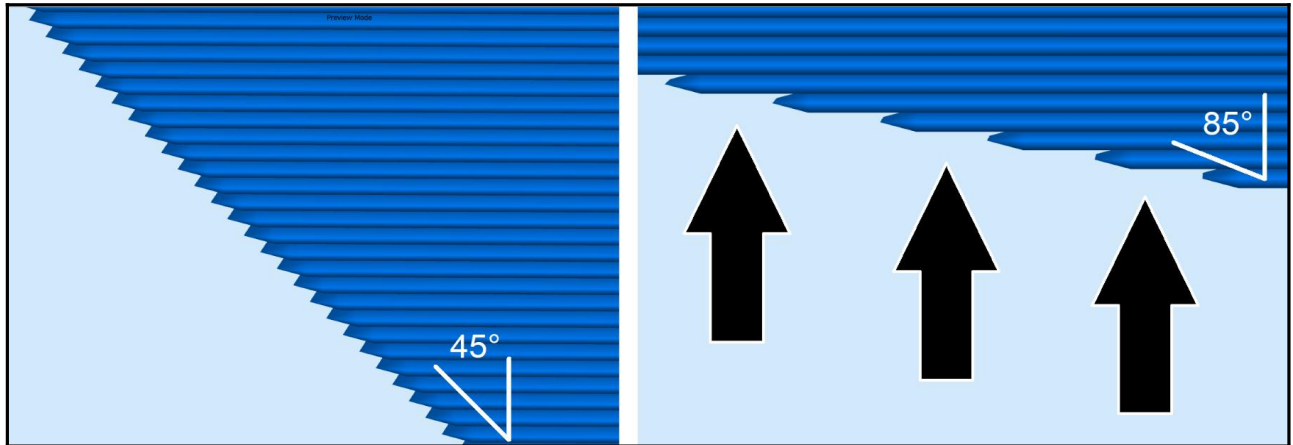

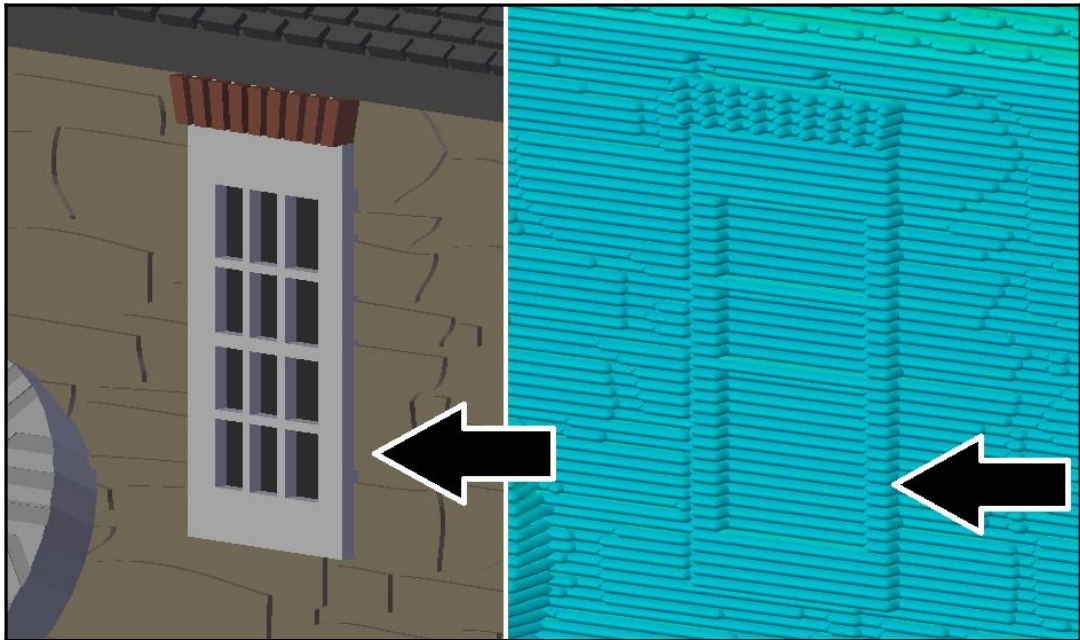
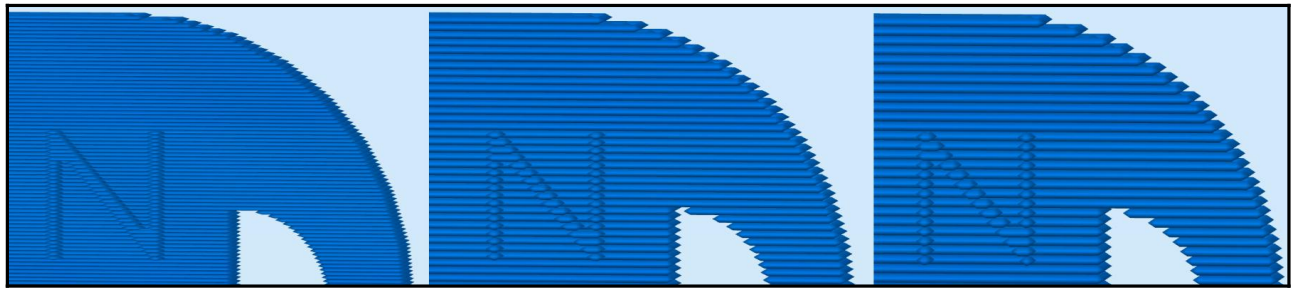
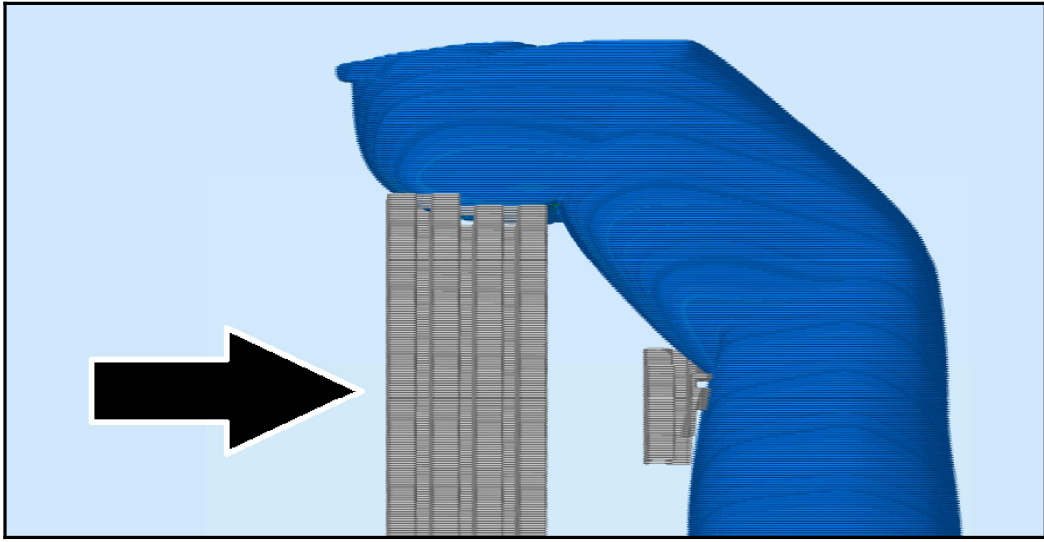
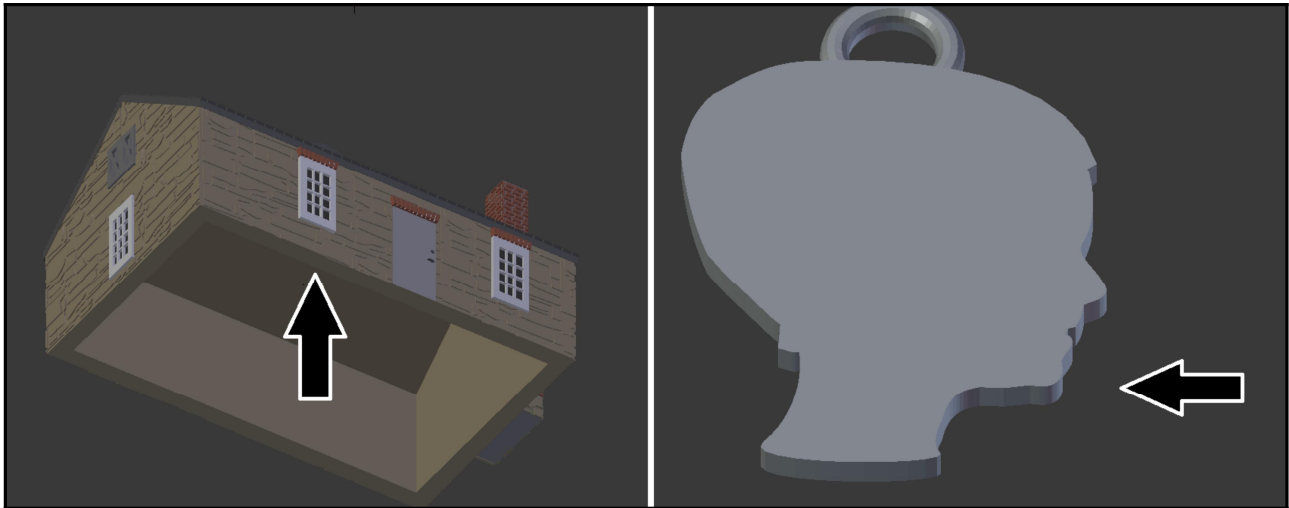
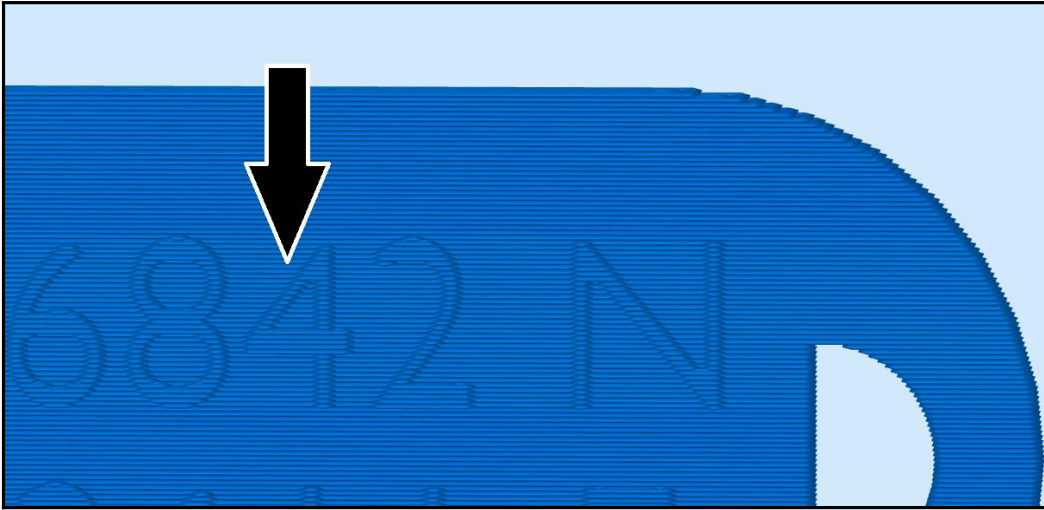
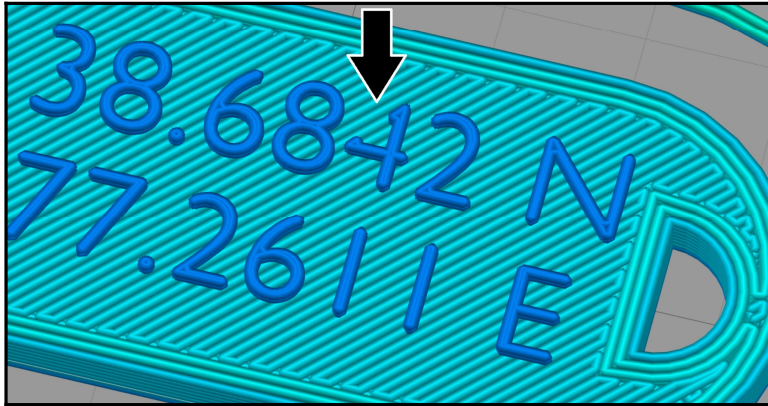
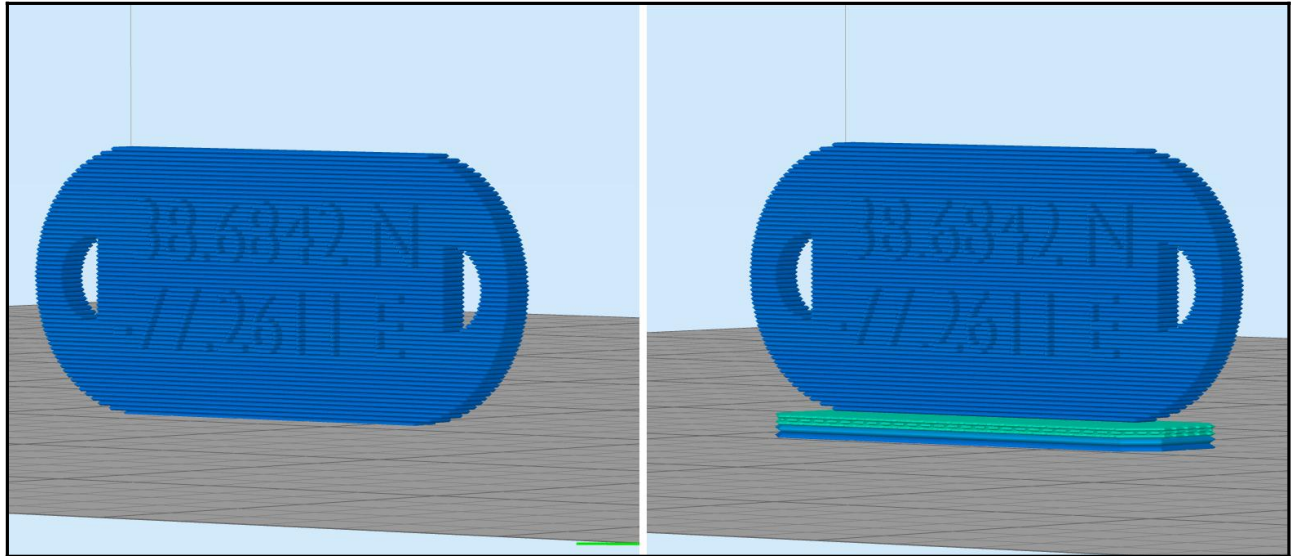

**shapeways** Shop Make a Product Community

How it Works Materials Creator Apps Tutorials Setting For Business UPLOAD

### Silver Material Information

All materials: Silver

Overview Design guidelines Material info Examples Order material sample kits

Beautiful Pictures of 3D Printed Silver

Interlocking Metals | Shapeways Materials

**i.materialise** DESIGN BUY HELL LEARN INPIRE UPLOAD 3D MODEL

Design Specifications

Pricing Info

Typical Use

Technology

Additional Information

Sample Kit

Priority Service

#### Design Specifications

Minimum Wall Thickness	0.8 to 1mm
Minimum Details	0.3 mm
Accuracy	±0.3% (with a lower limit of ±0.3 mm)
Maximum Size	<ul style="list-style-type: none"> <li>650 x 330 x 560 mm (natural)</li> <li>650 x 330 x 560 mm (spray painted)</li> <li>200 x 200 x 200 mm (polished)</li> <li>200 x 150 x 150 mm (gold)</li> <li>400 x 400 x 330 mm (gold black)</li> <li>200 x 150 x 150 mm (gold and dye)</li> <li>150 x 150 x 150 mm (gold)</li> <li>200 x 150 x 150 mm (gold)</li> </ul>
Clearance	0.5 mm
Interlocking or Enclosed Parts?	Yes

**sculpteo** 3D Printing Laser Cutting Pricing Company Blog

printed larger than the printer bed. The same goes for our polishing and painting services - if it doesn't fit, it can't be used.

There is no minimum size for polycarbonate prints, keeping in mind minimum thickness for walls and structural aspects, to ensure the object will not break in 0.8 mm.

#### Minimum Thickness and Geometry of Your 3D Model

Minimum wall thickness (flexible)	0.8mm
Minimum wall thickness (rigid)	2mm
Minimum wall thickness (stressed elements)	3mm with supports 5mm without support
Minimum wall thickness particular design aspects	1.2mm

# Chapter 2: Using a Background Image and Bezier Curves

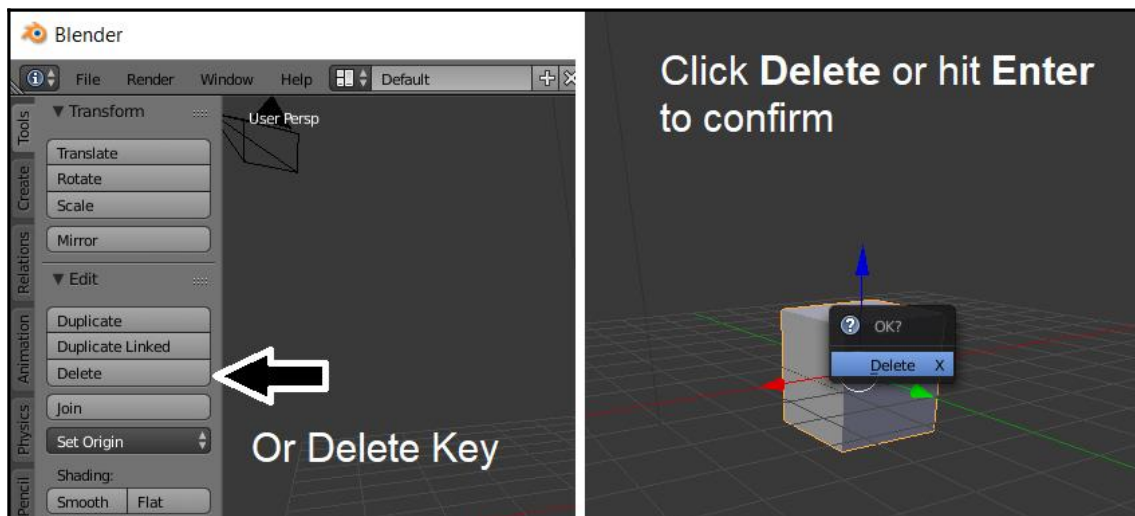
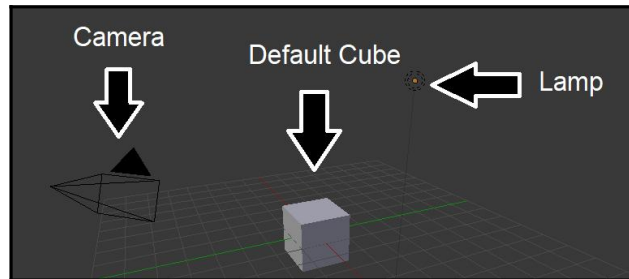

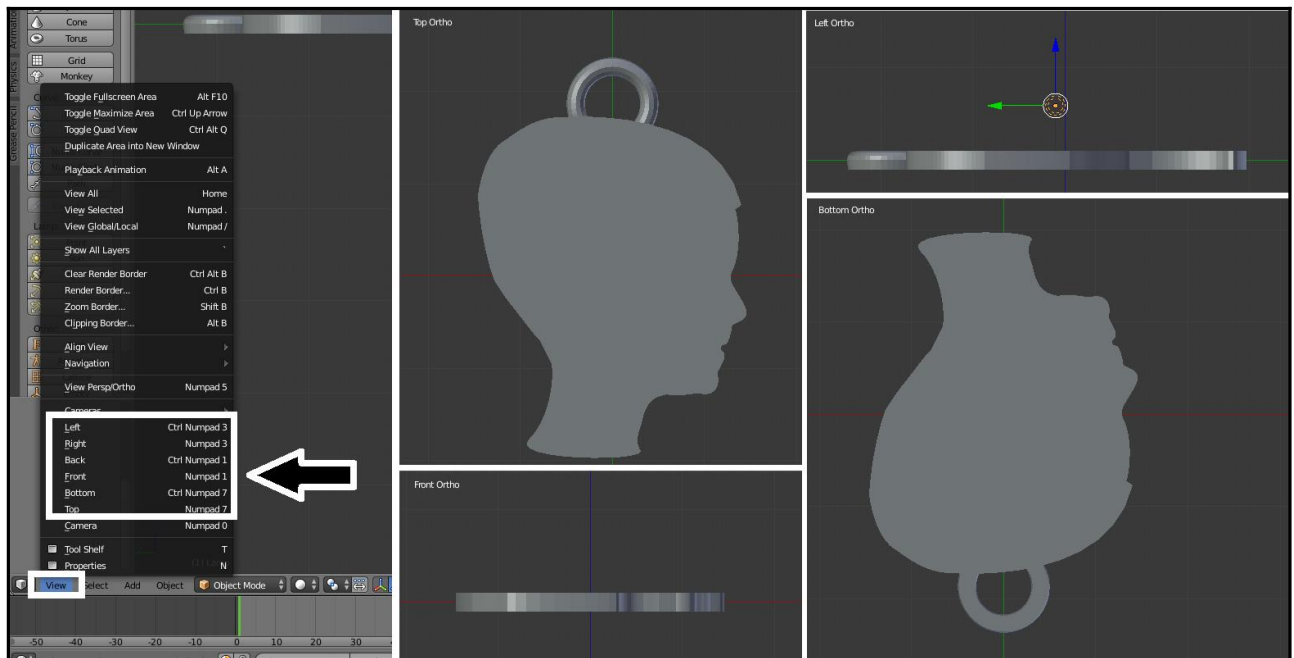
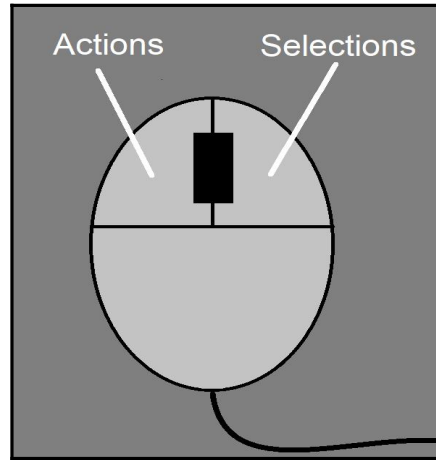

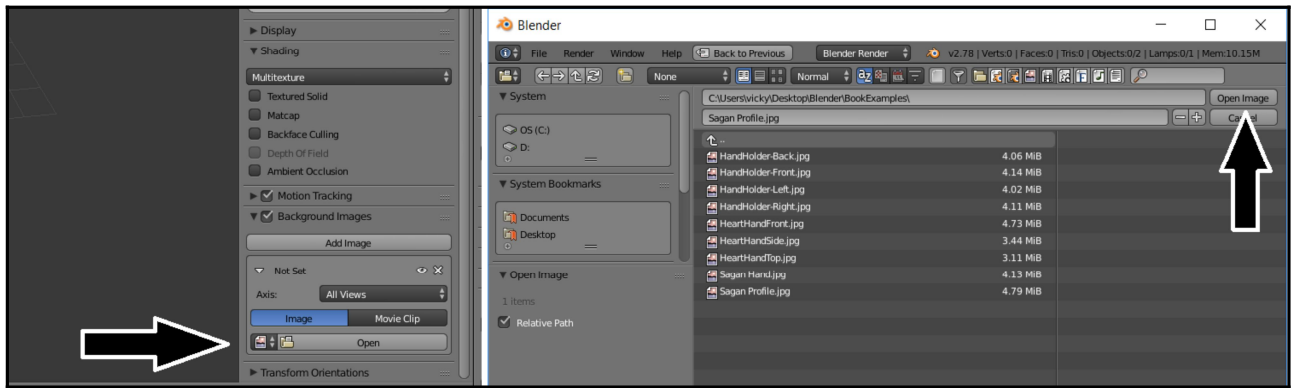
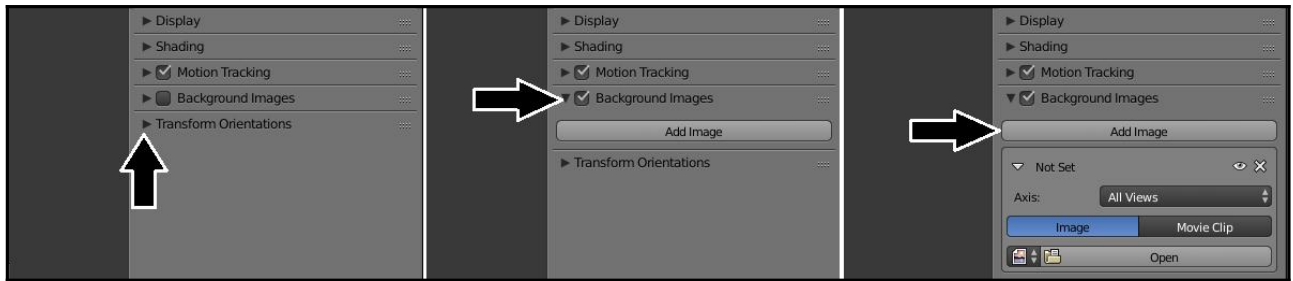
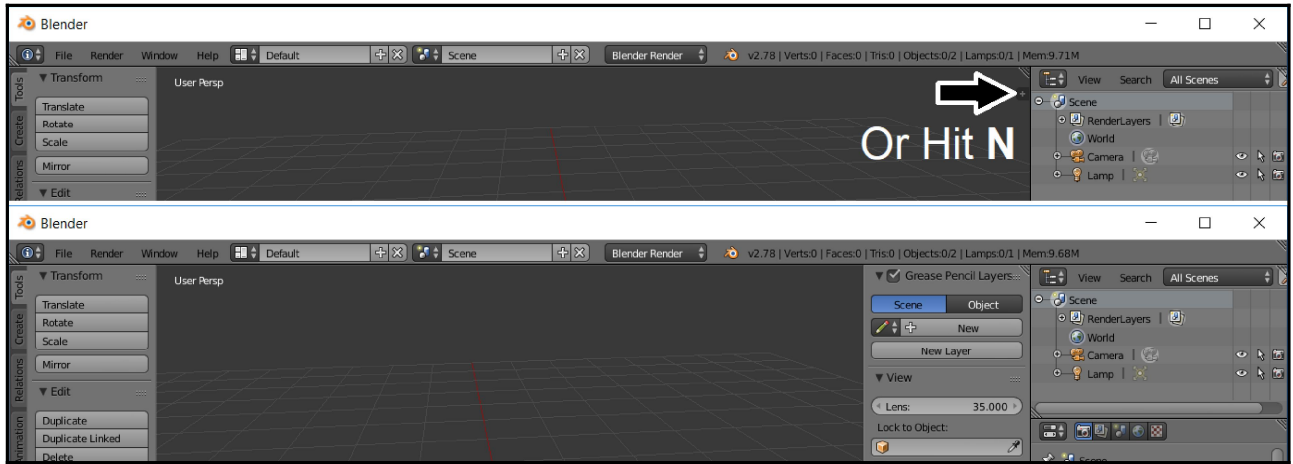

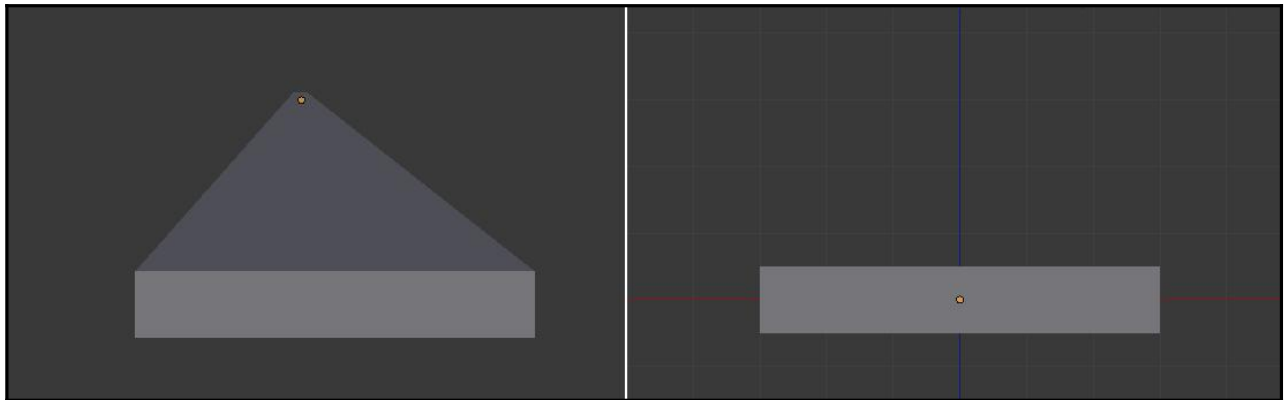
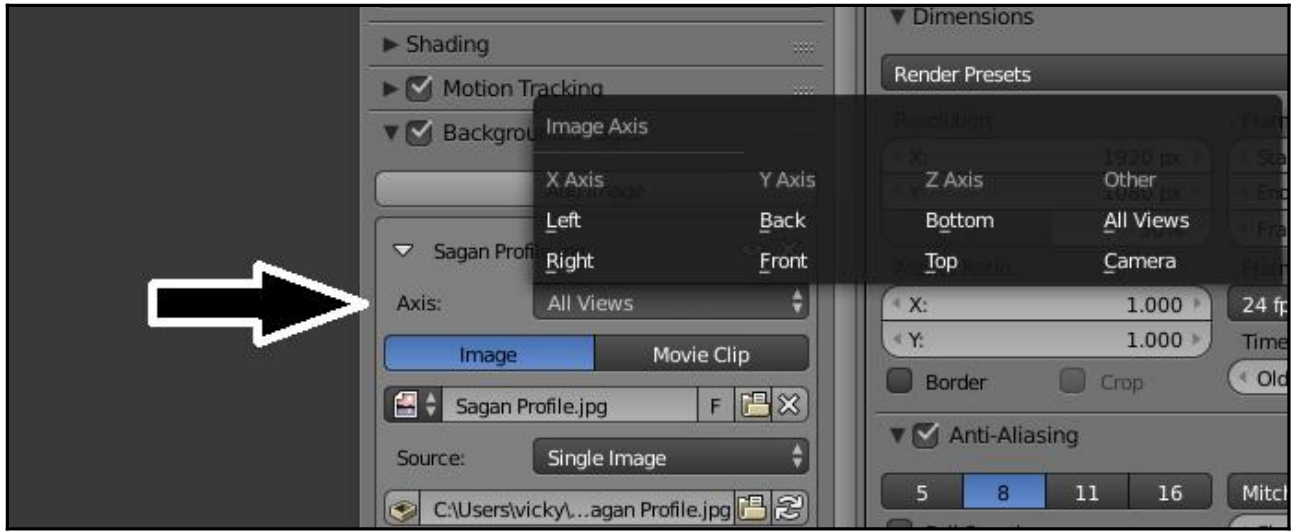



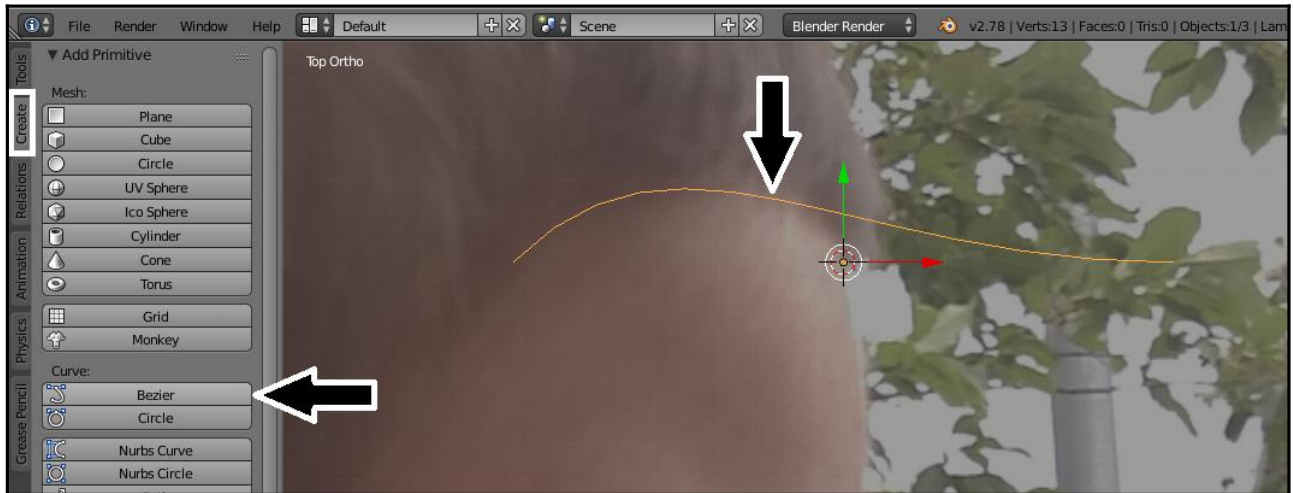
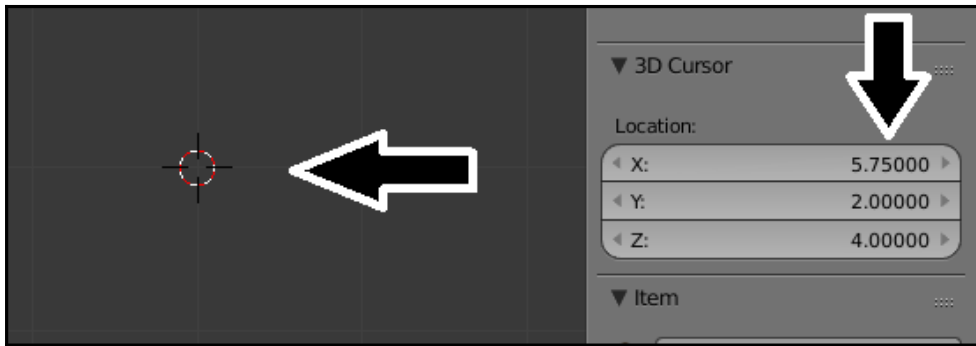
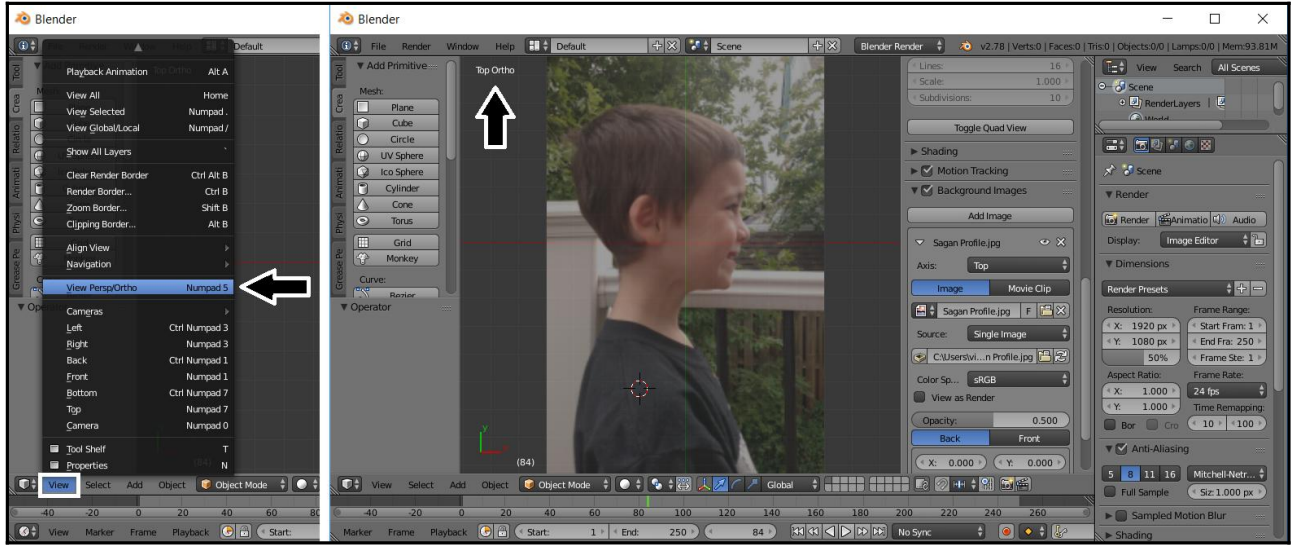

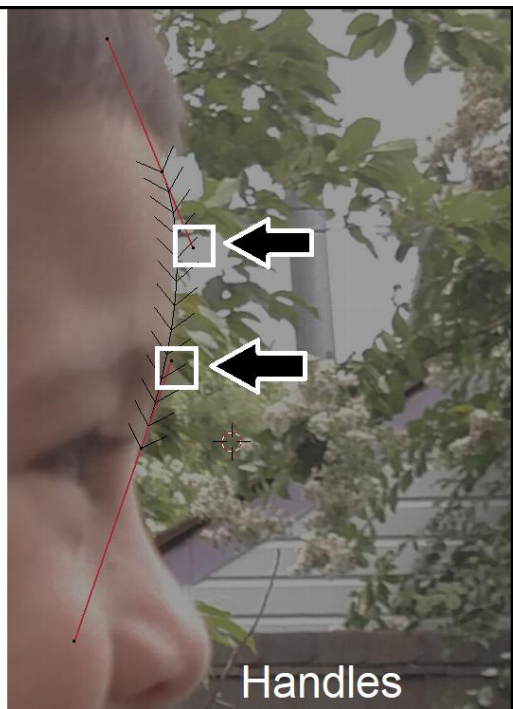
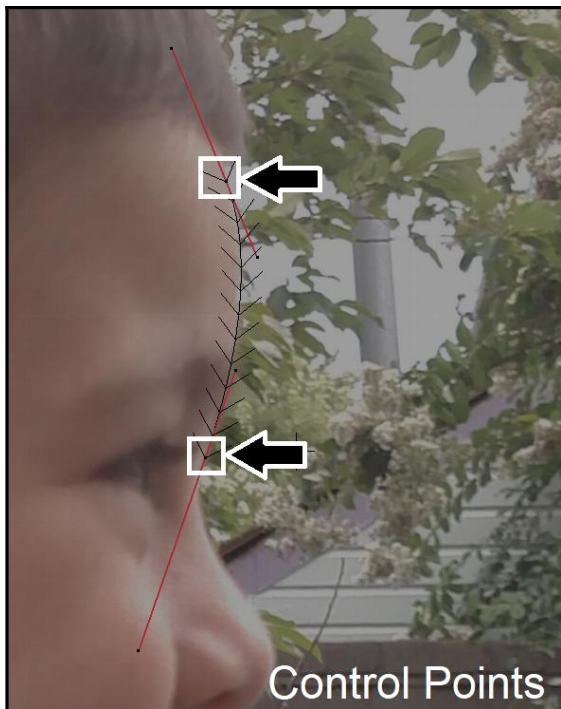
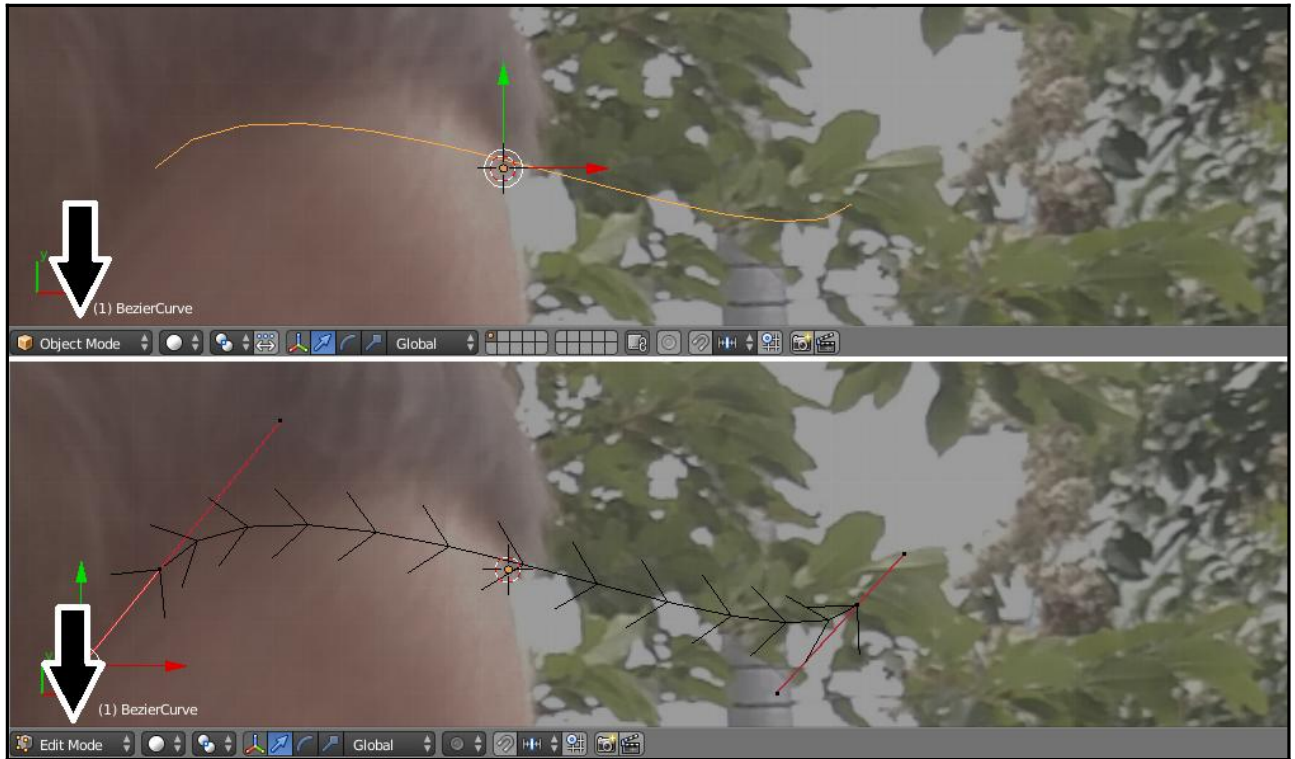

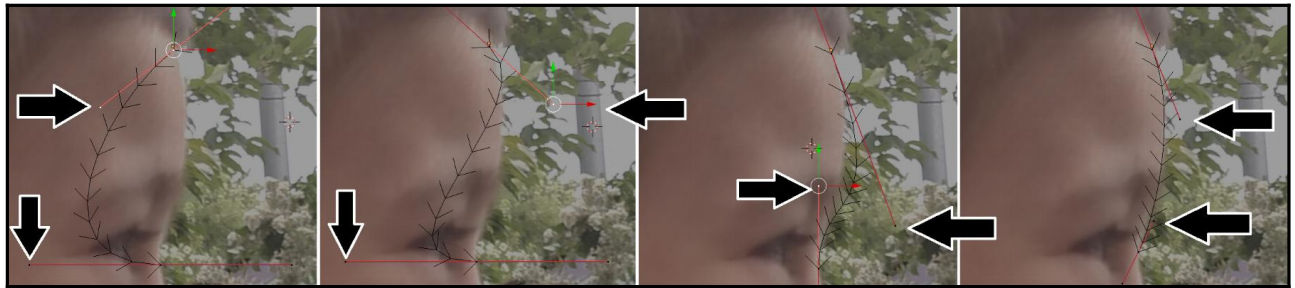
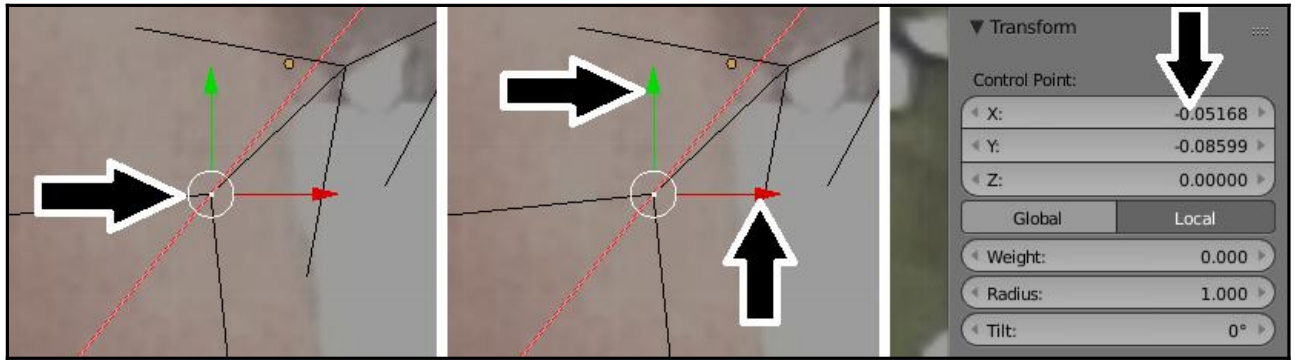

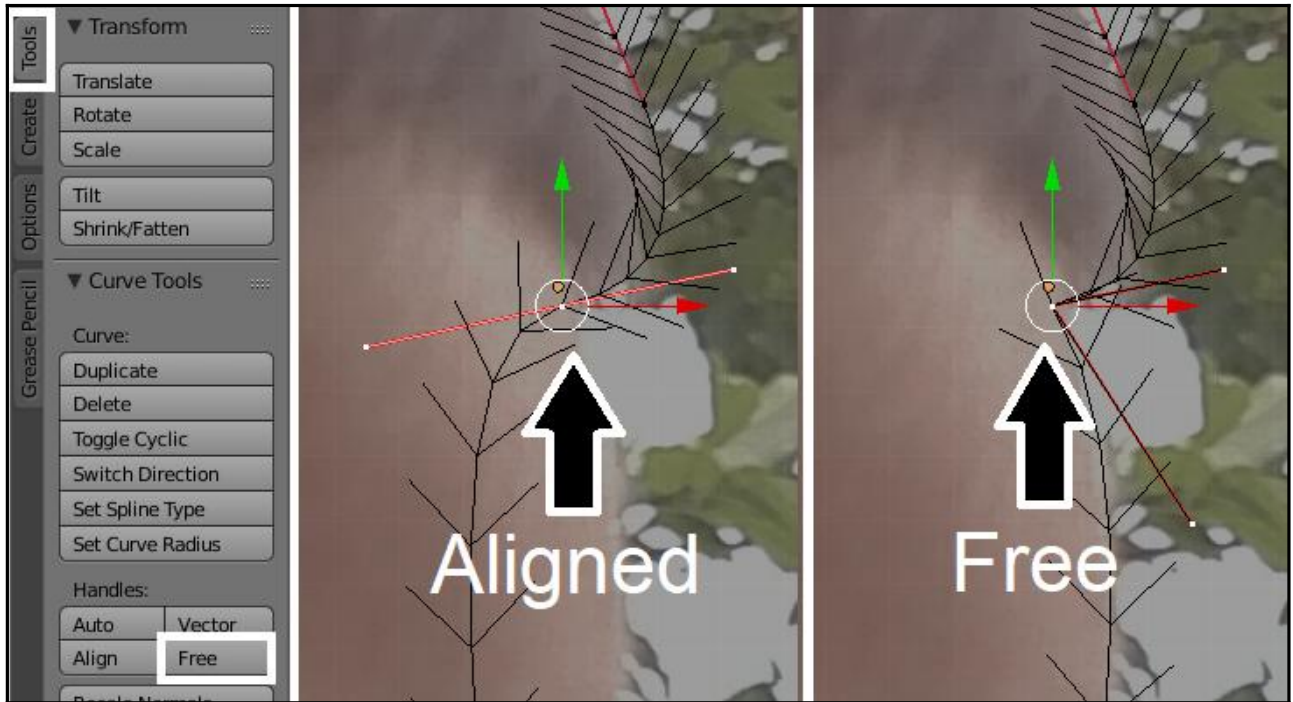
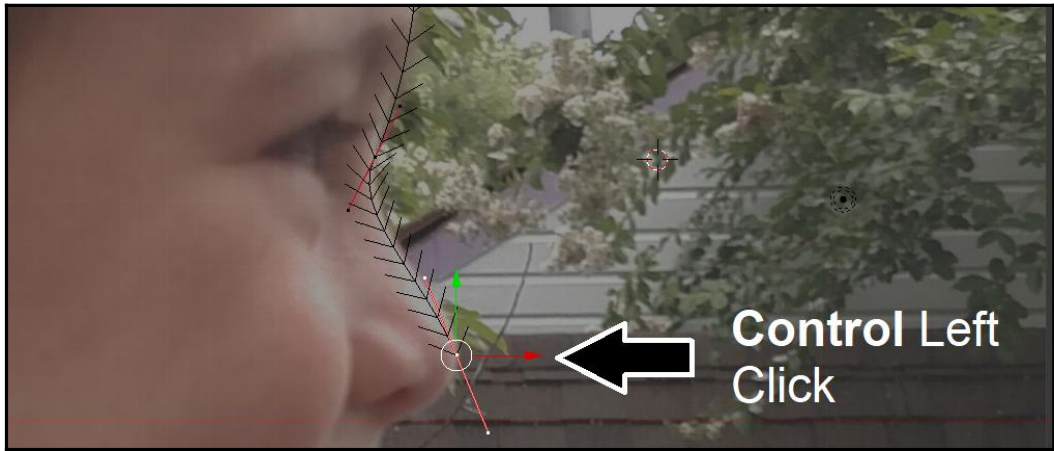

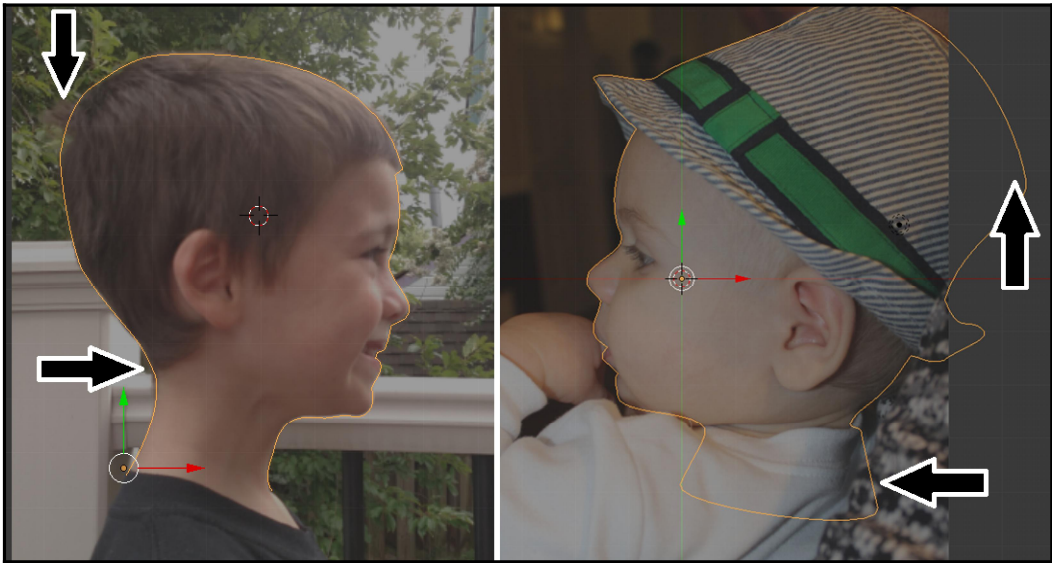
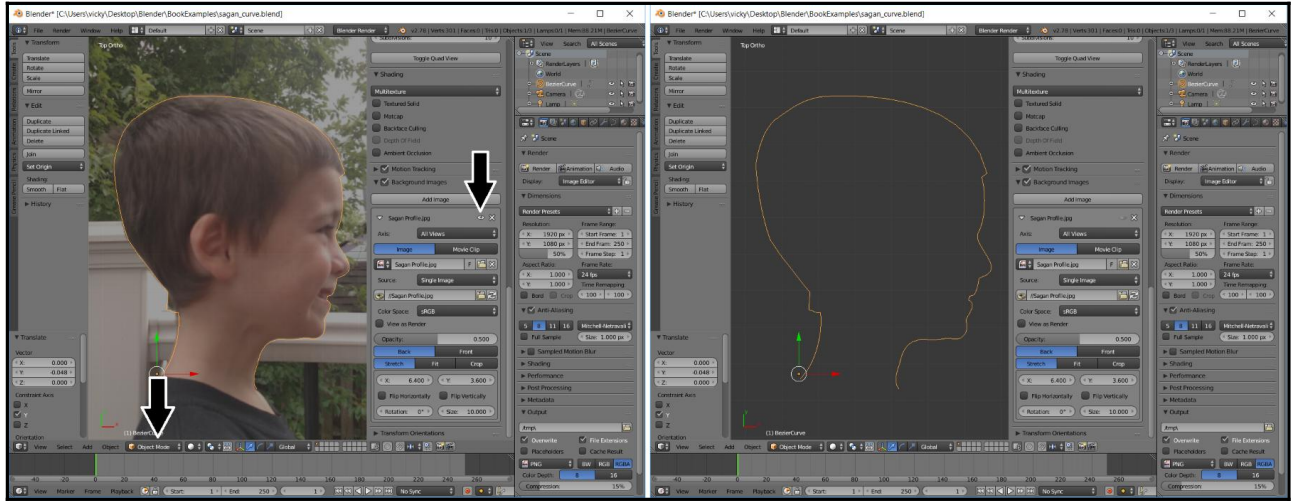

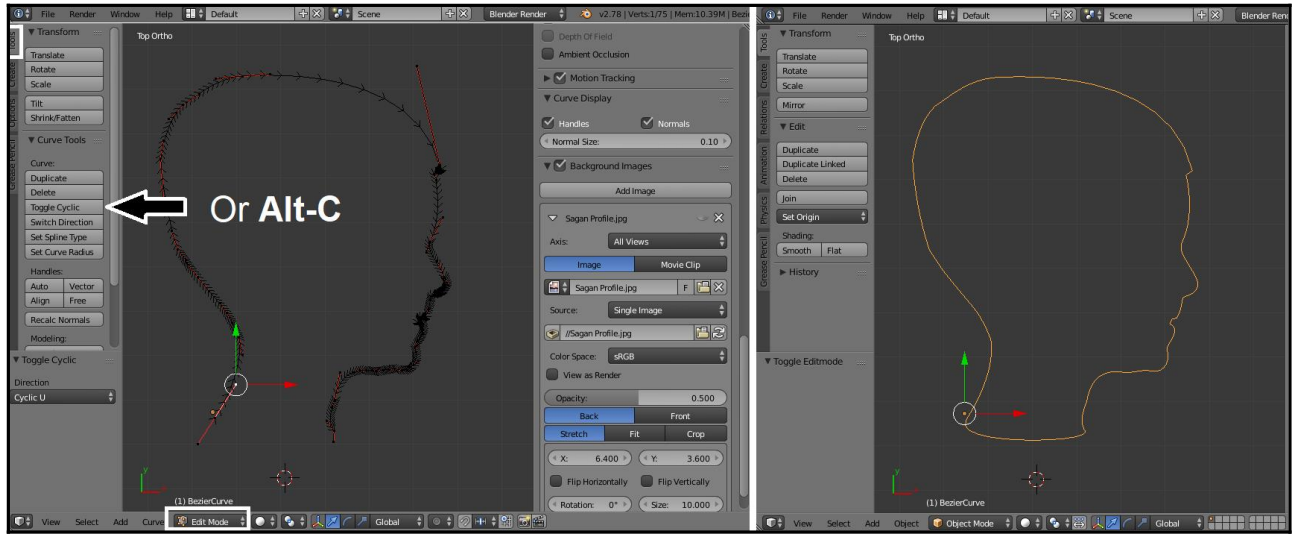

# Chapter 3: Converting a Bezier Curve to a Properly Sized 3D Mesh



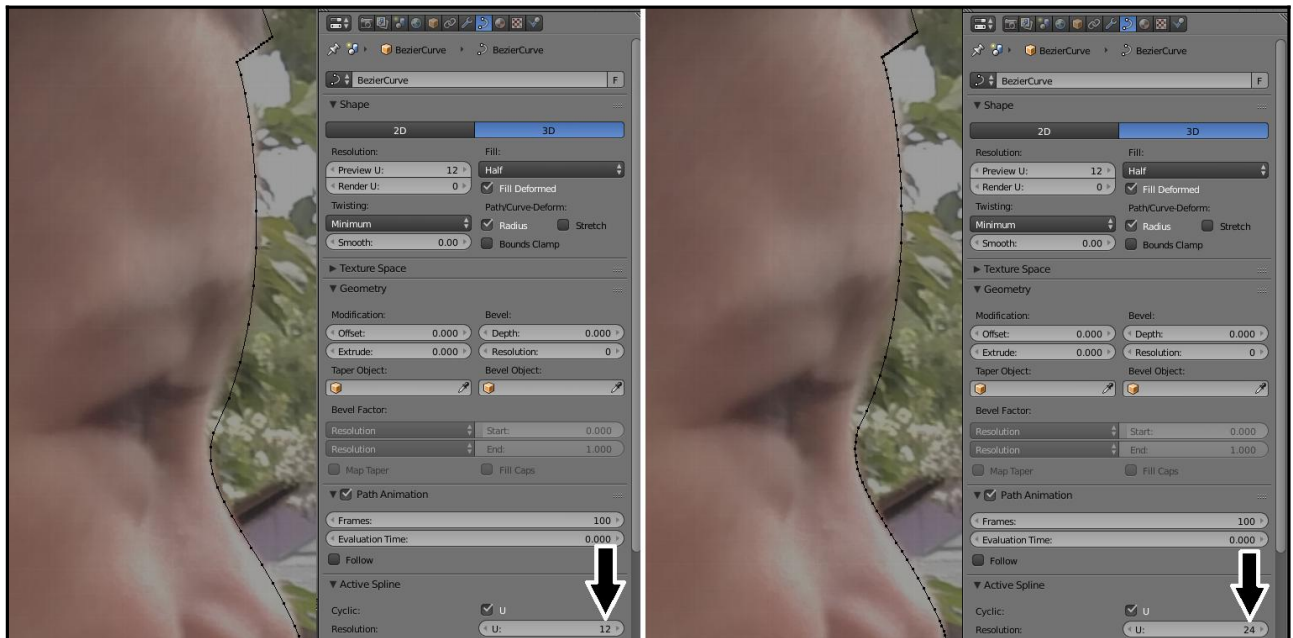
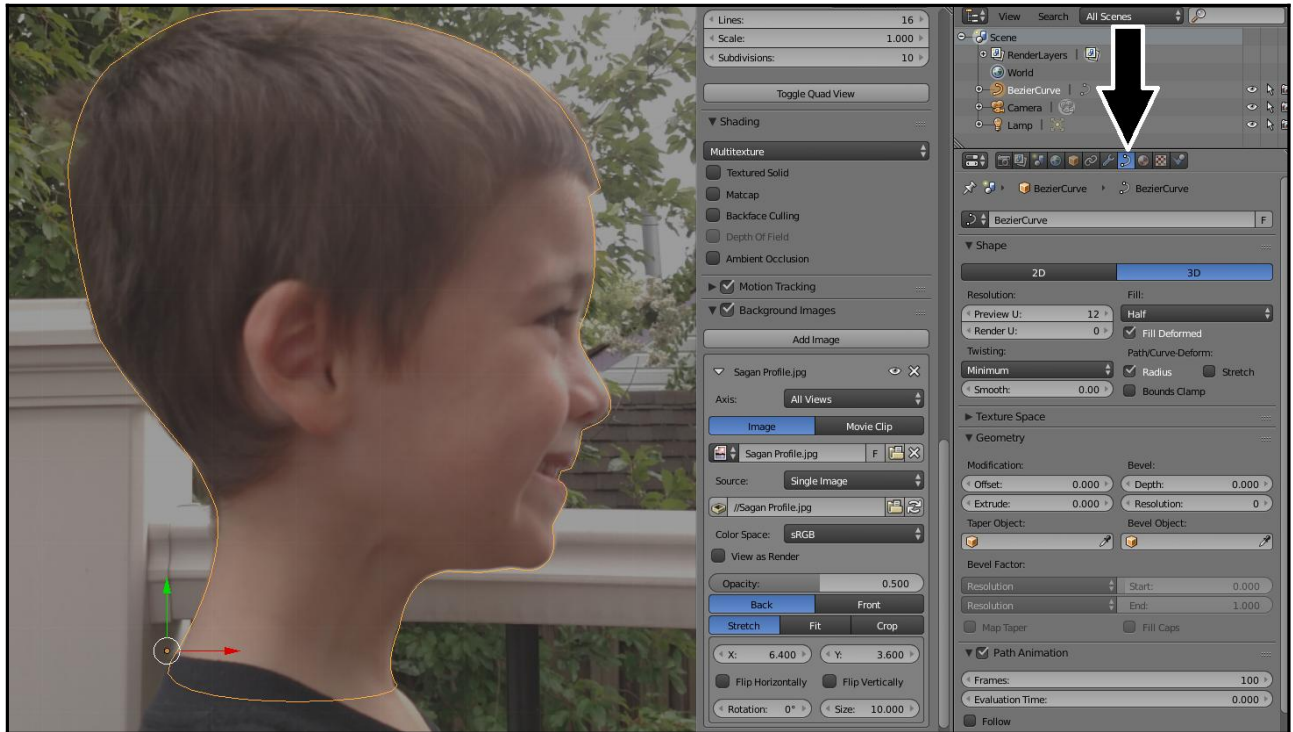



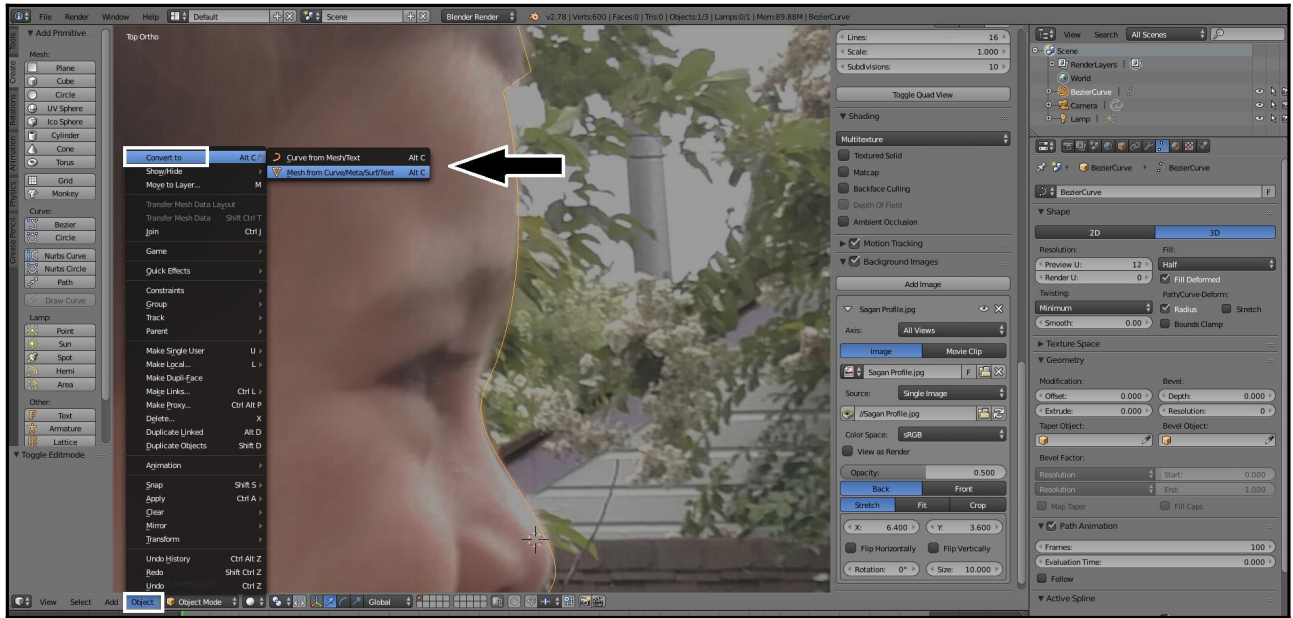

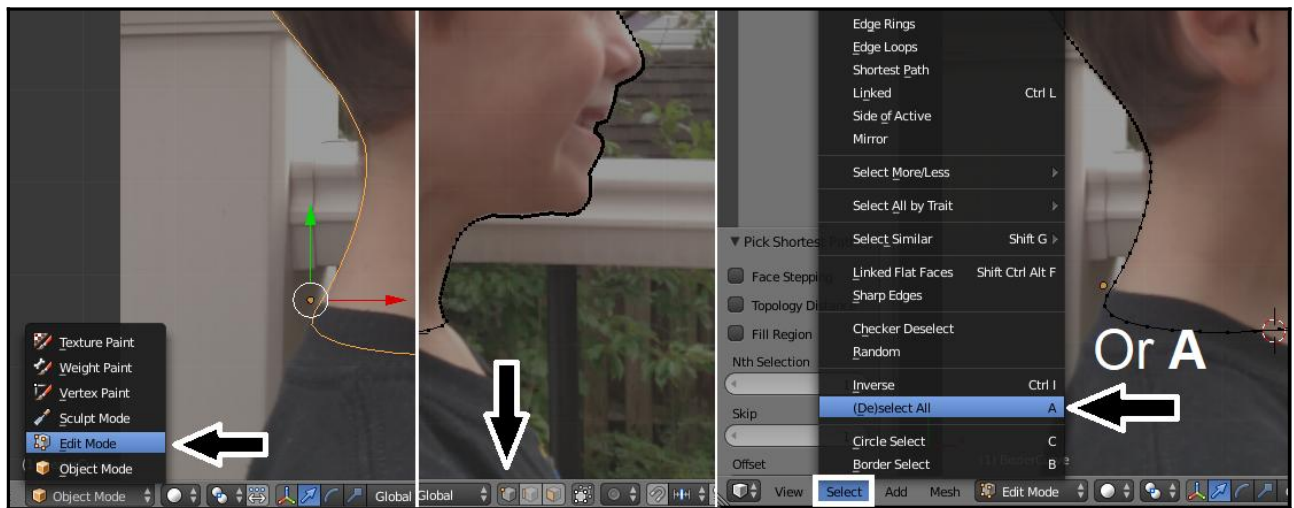
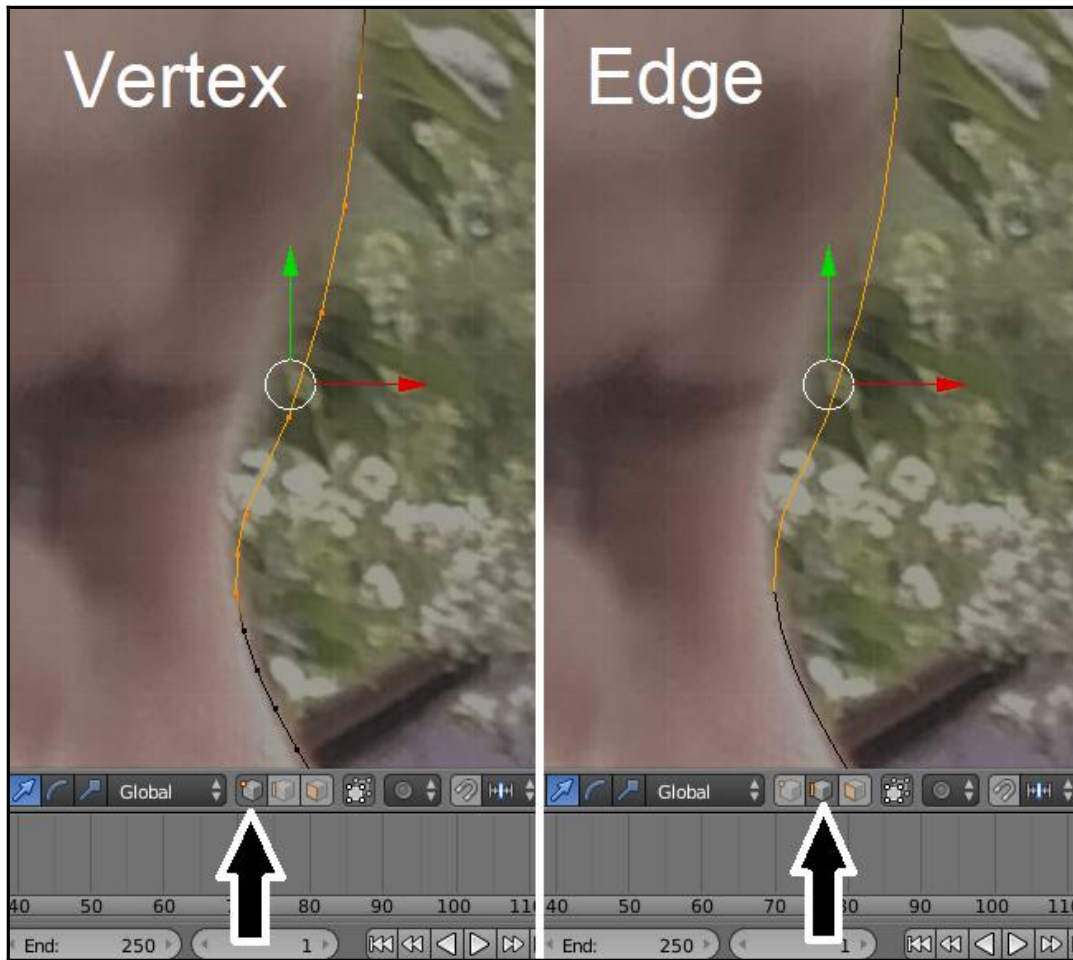

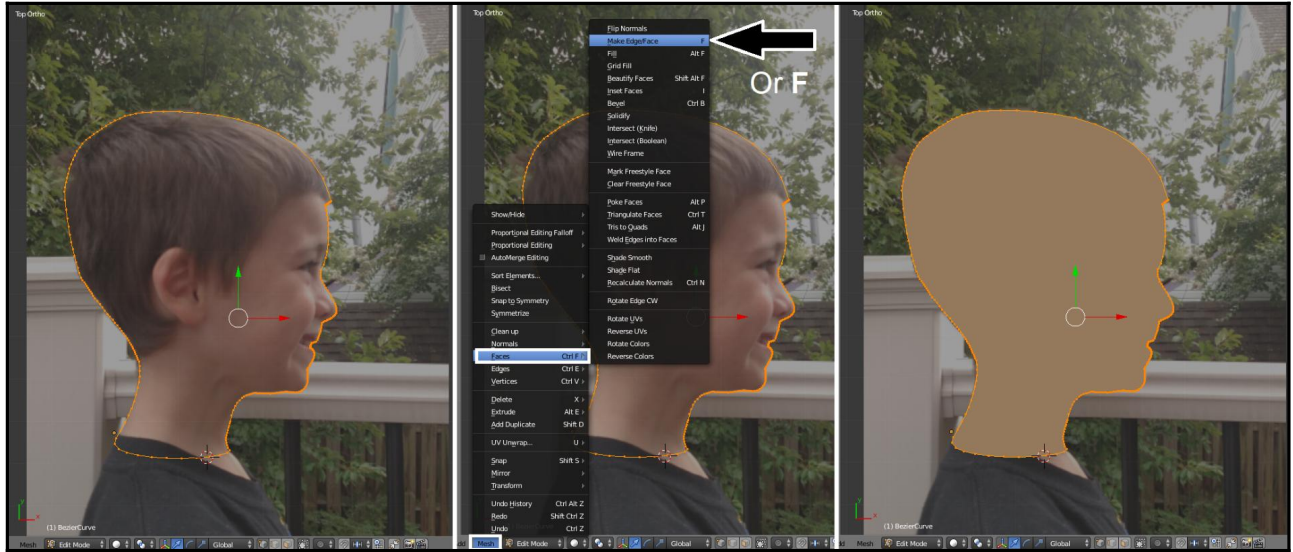

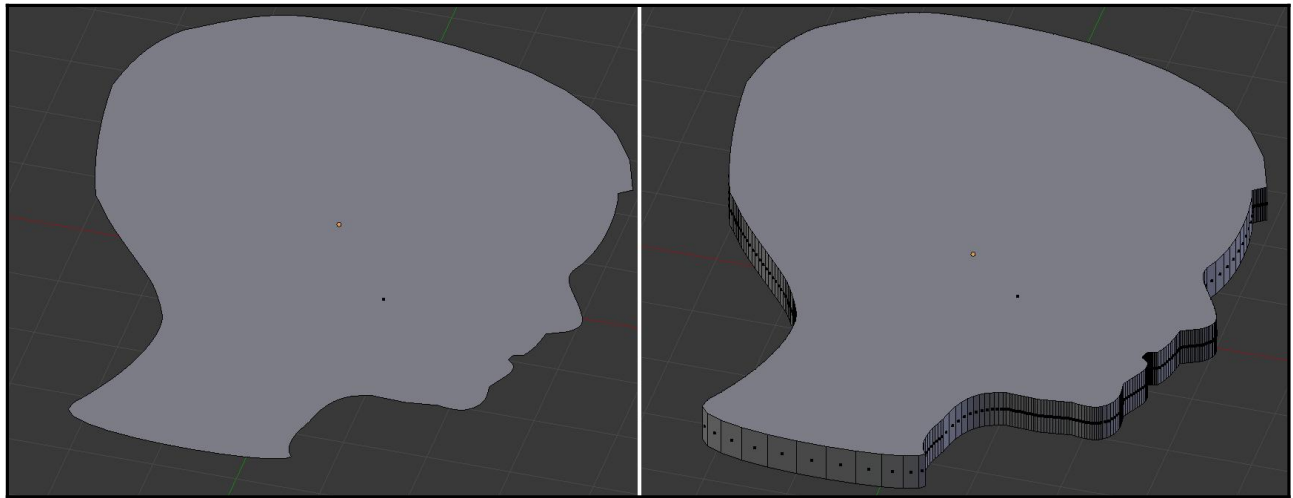
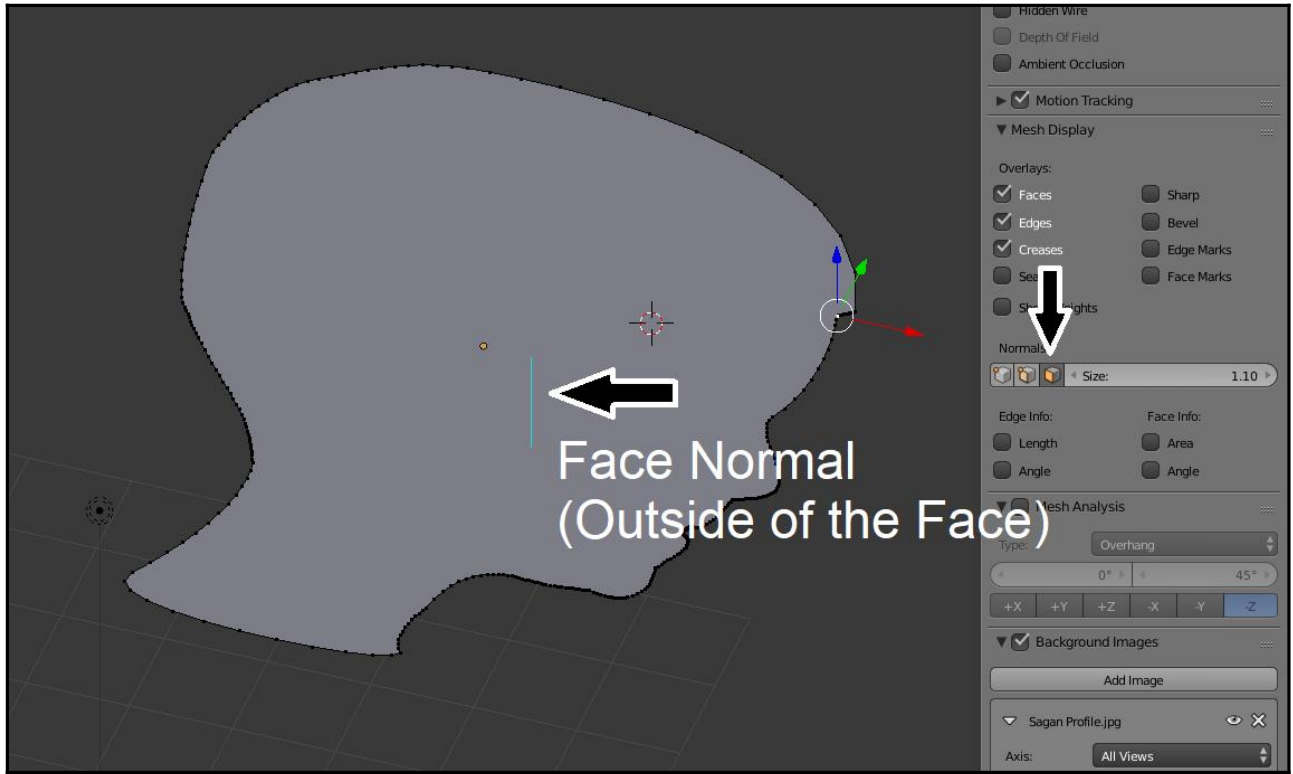

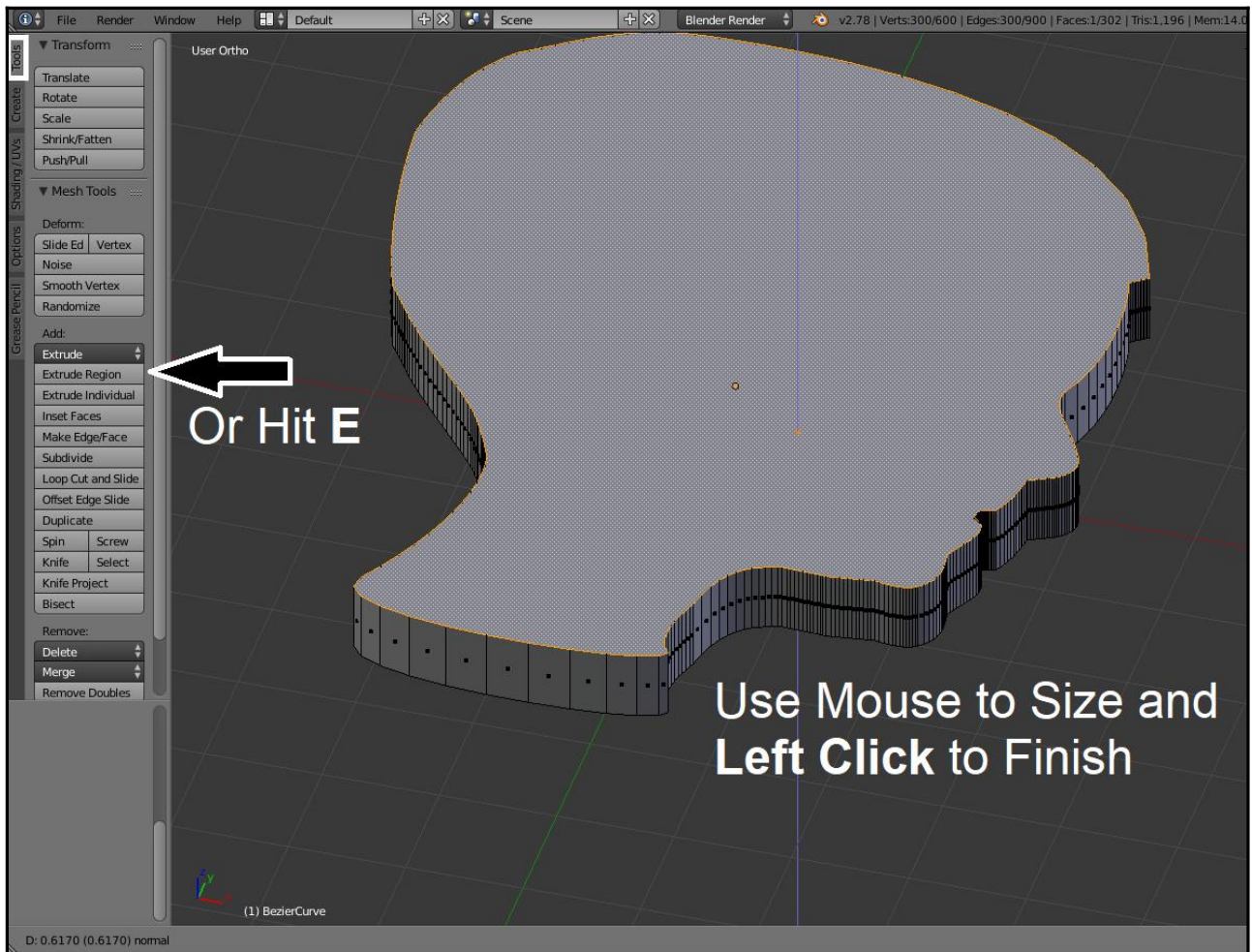
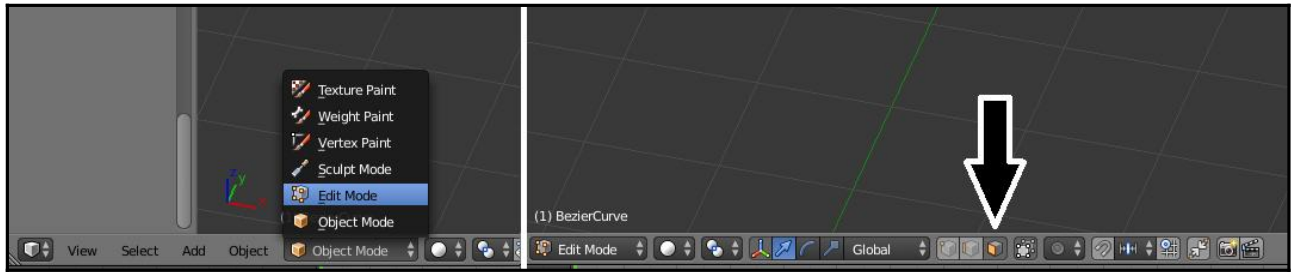

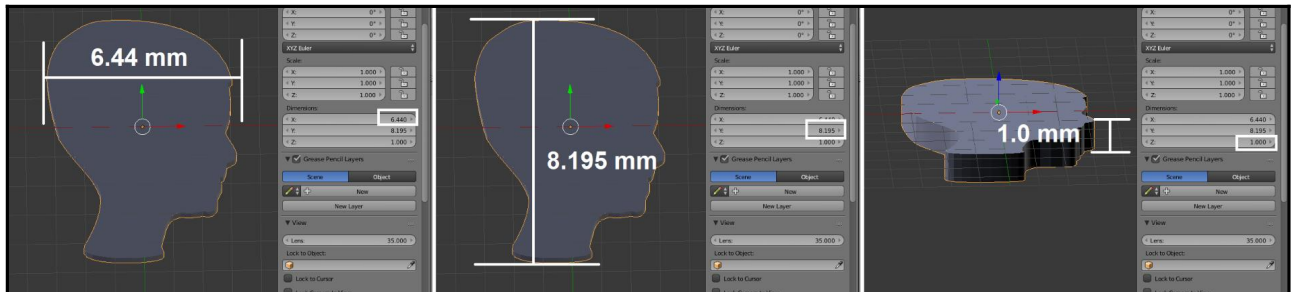
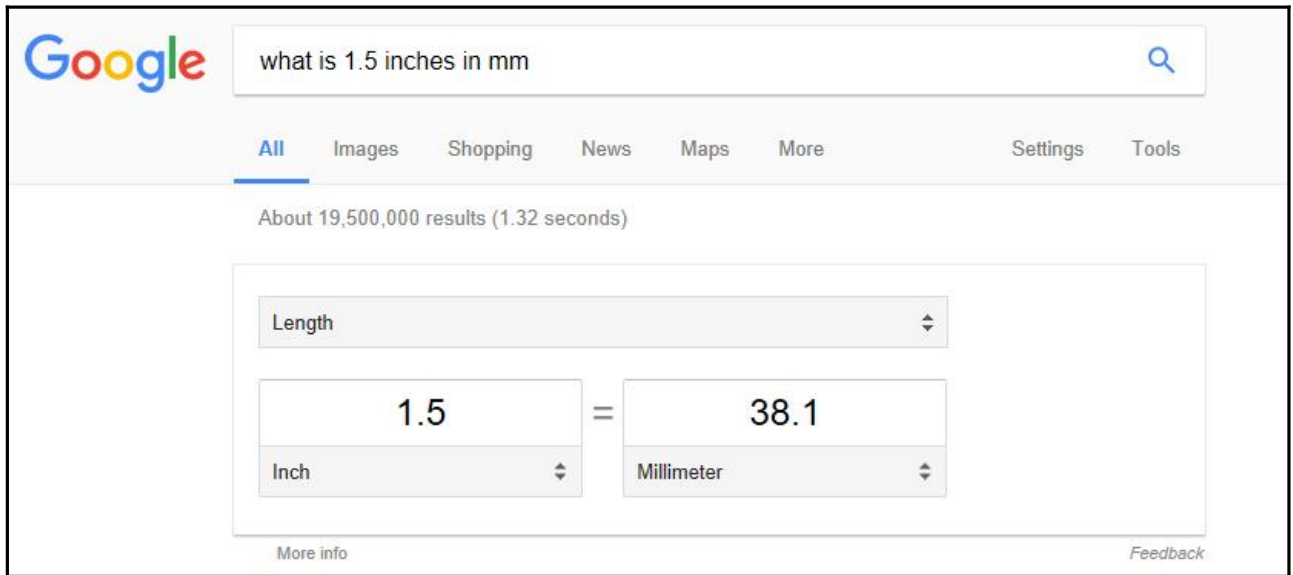
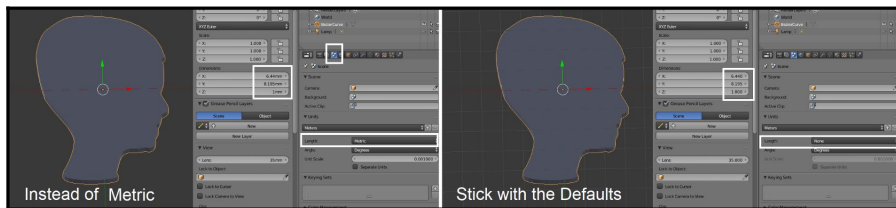
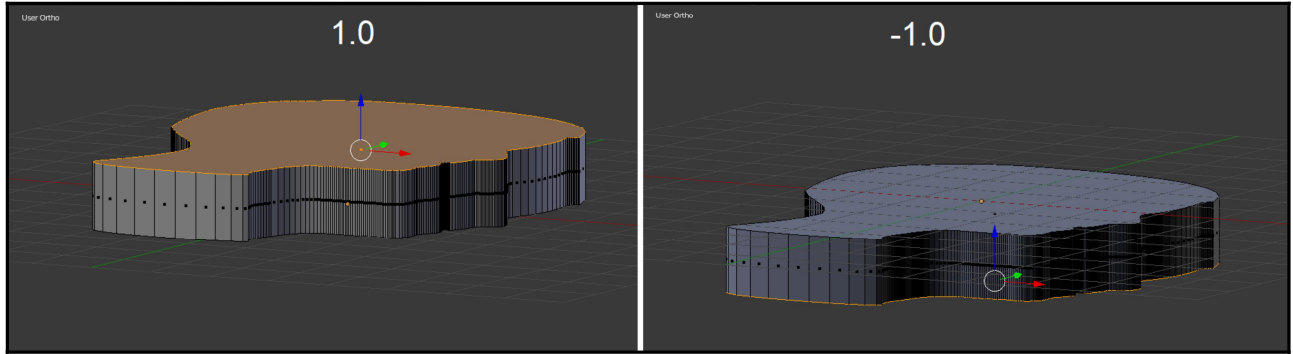

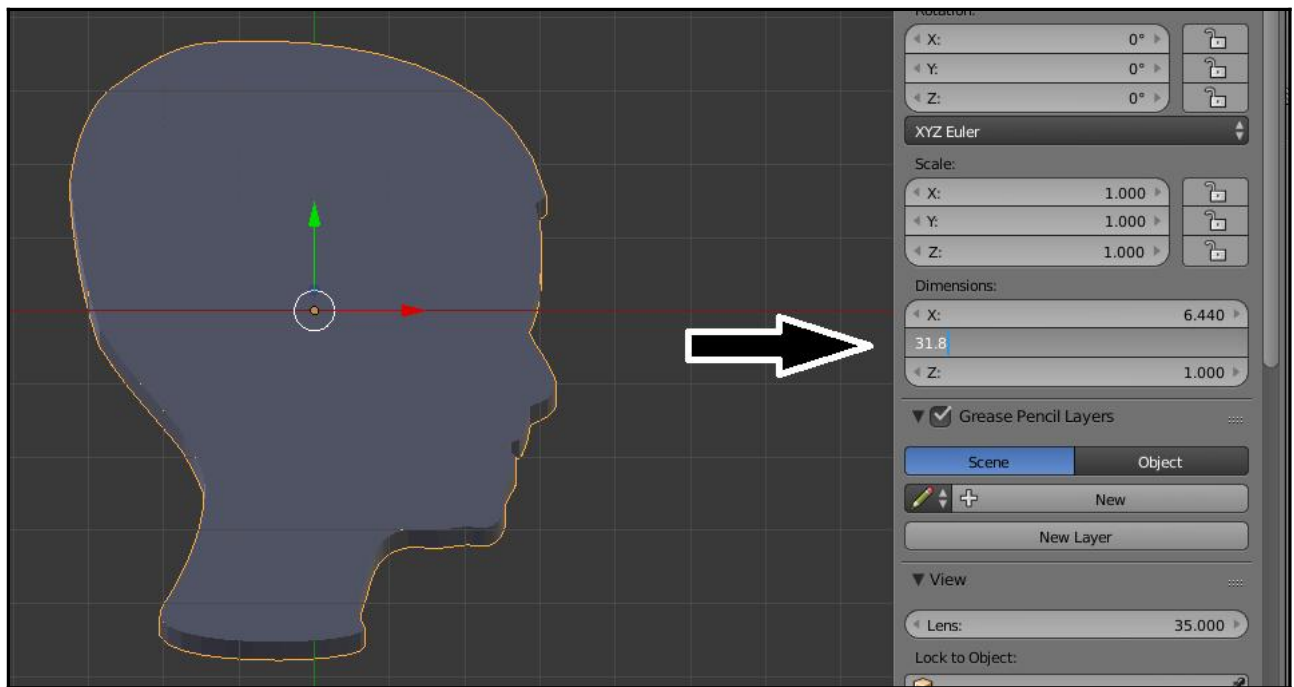
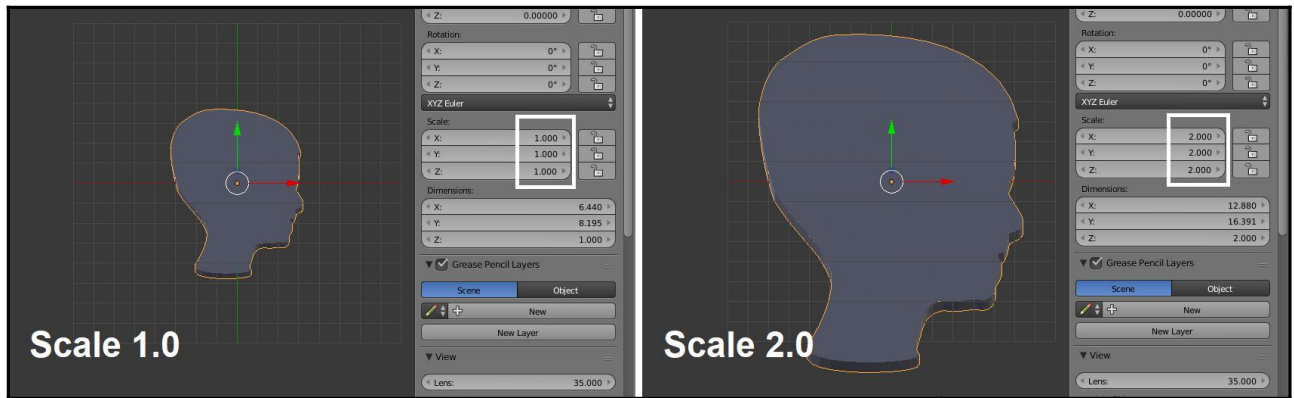

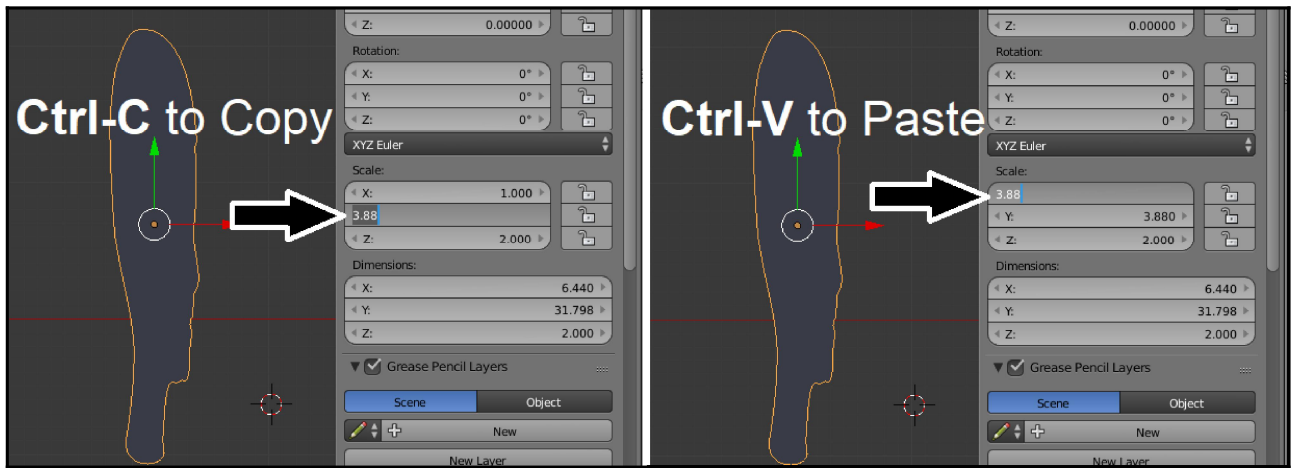
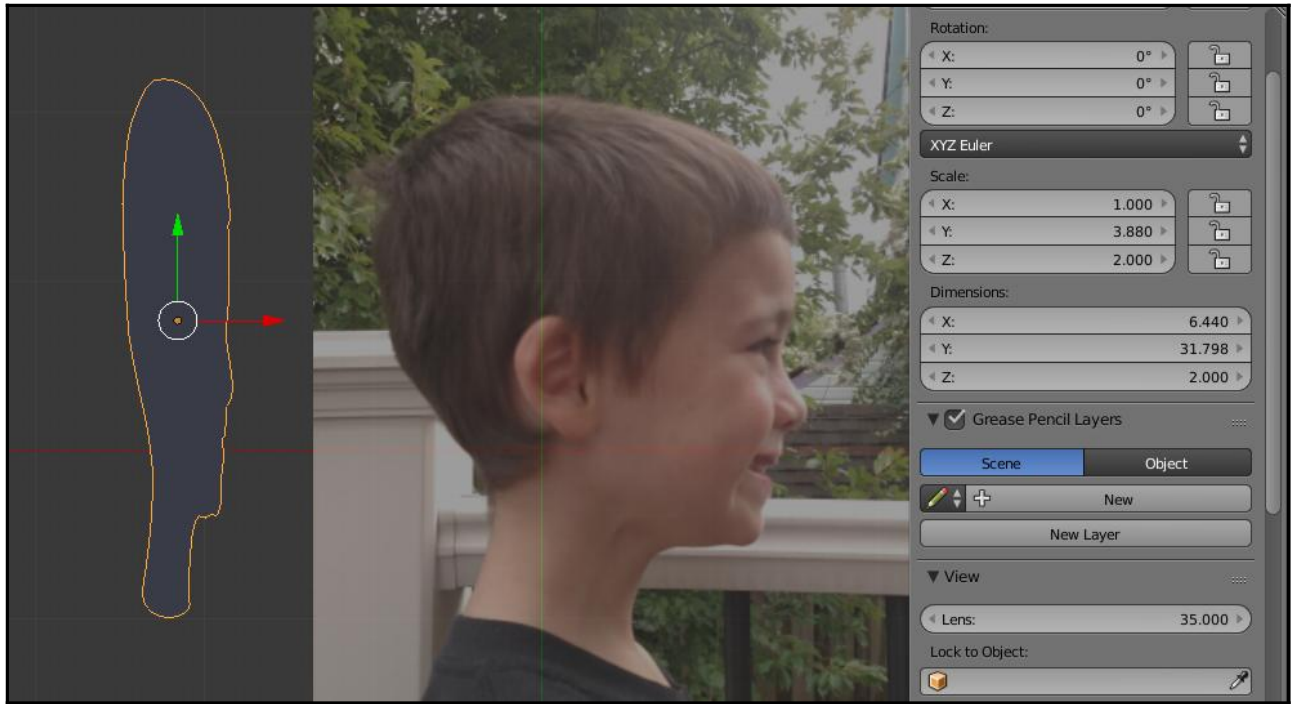



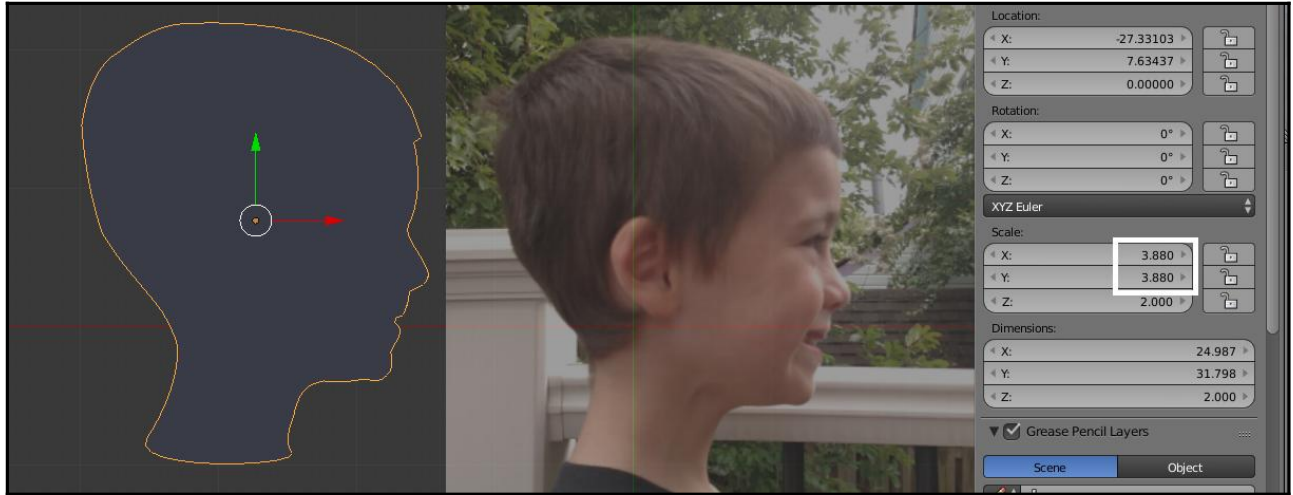

# Chapter 4: Flattening a Torus and Boolean Union

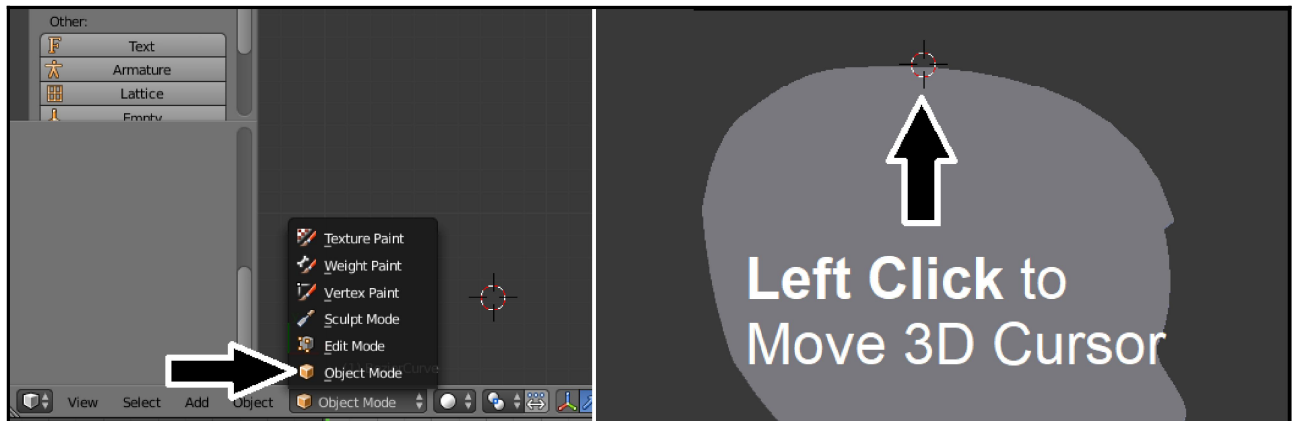
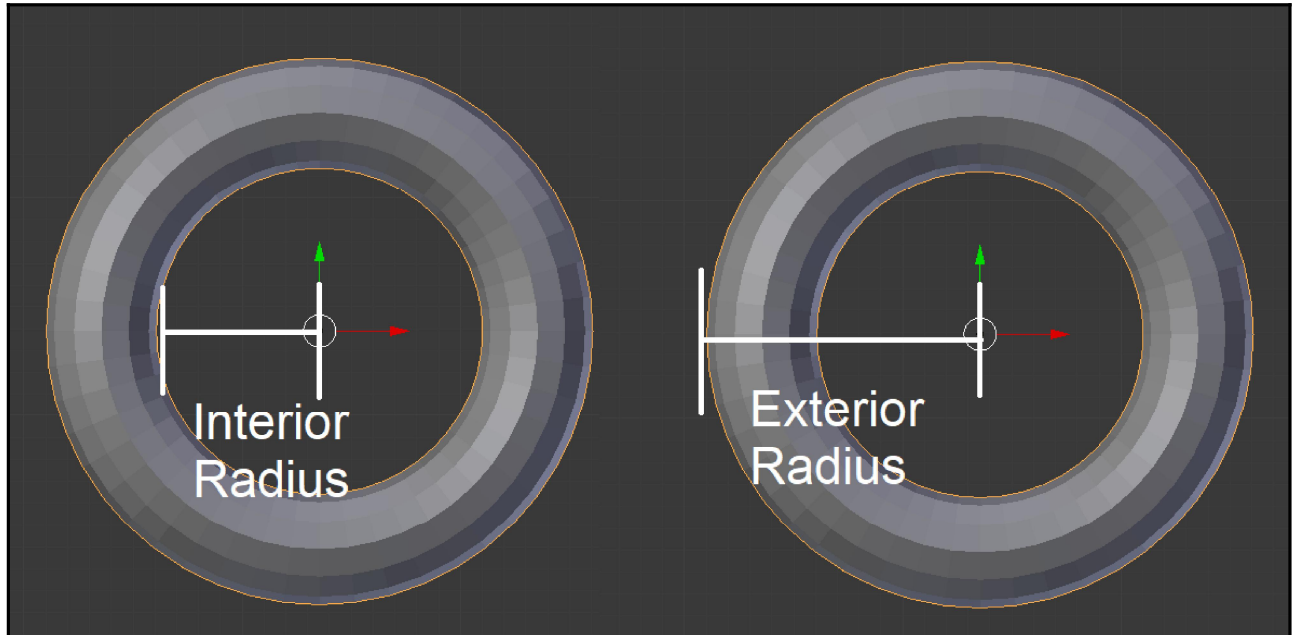

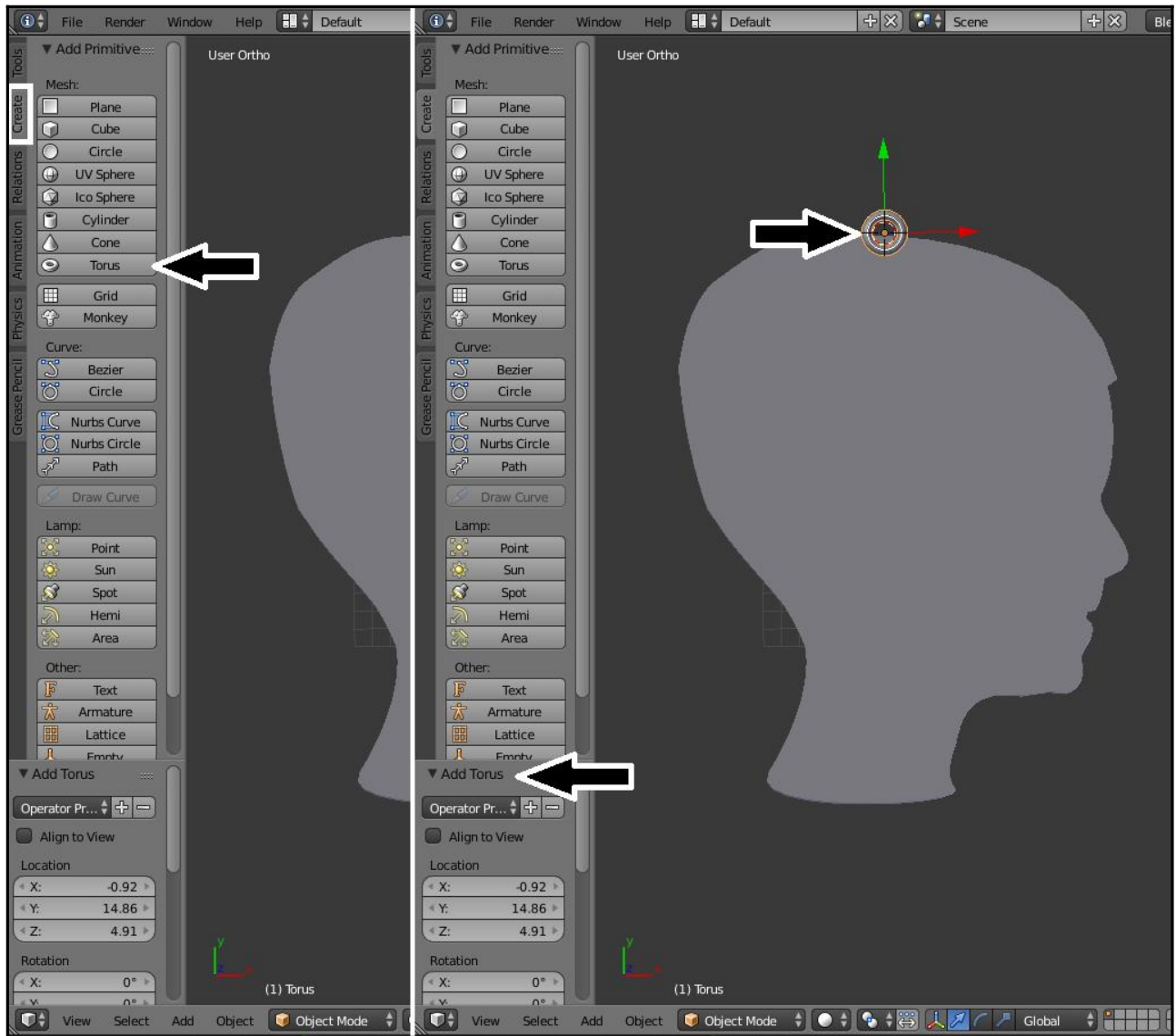

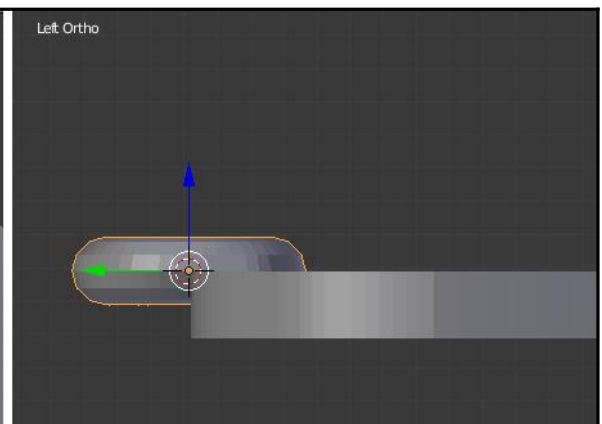
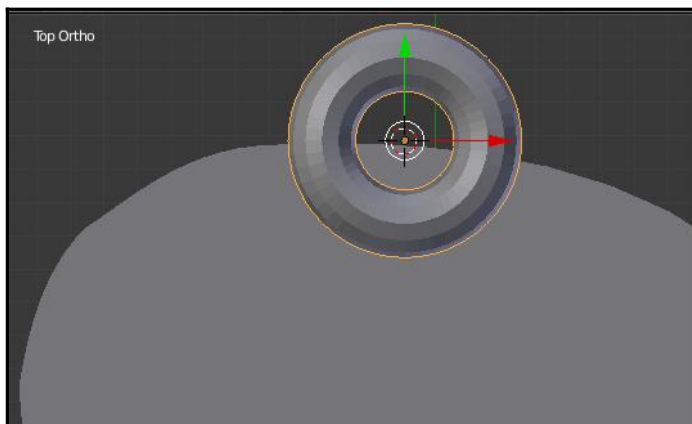
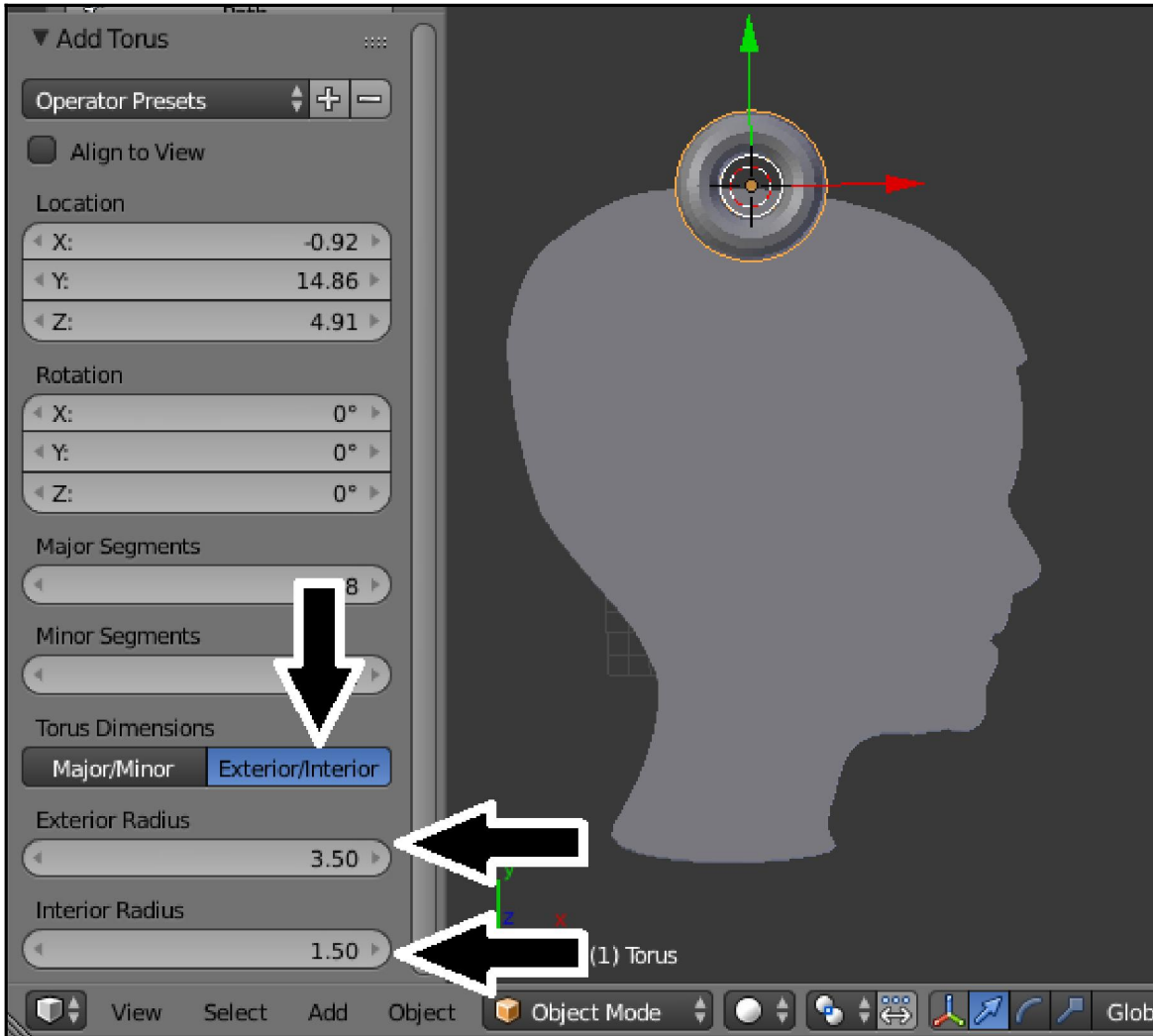

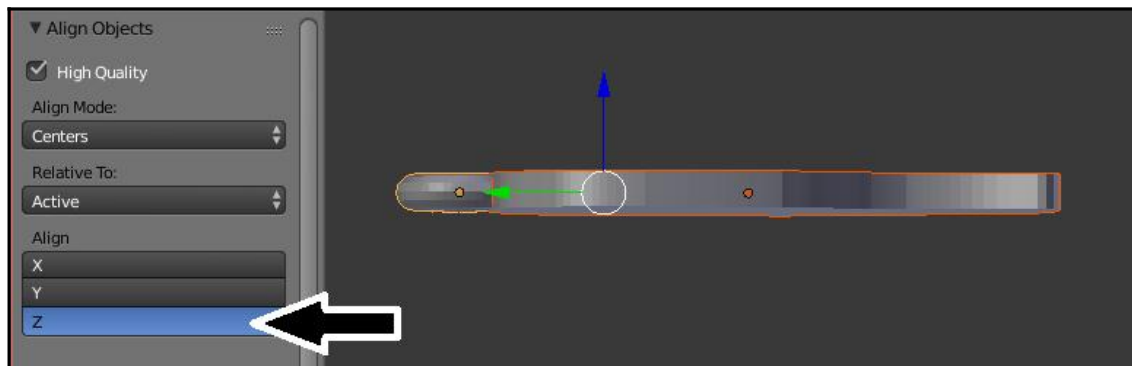
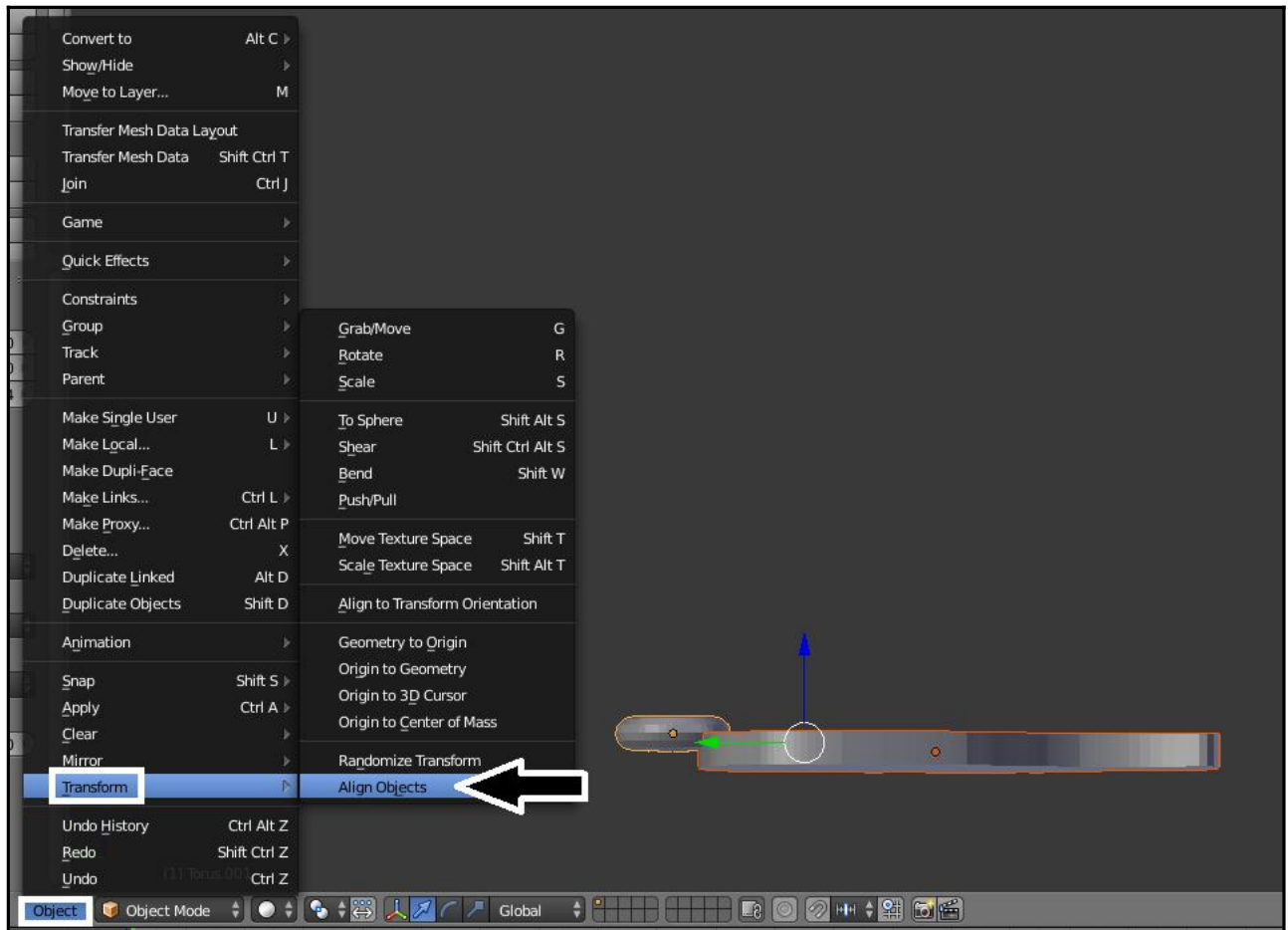

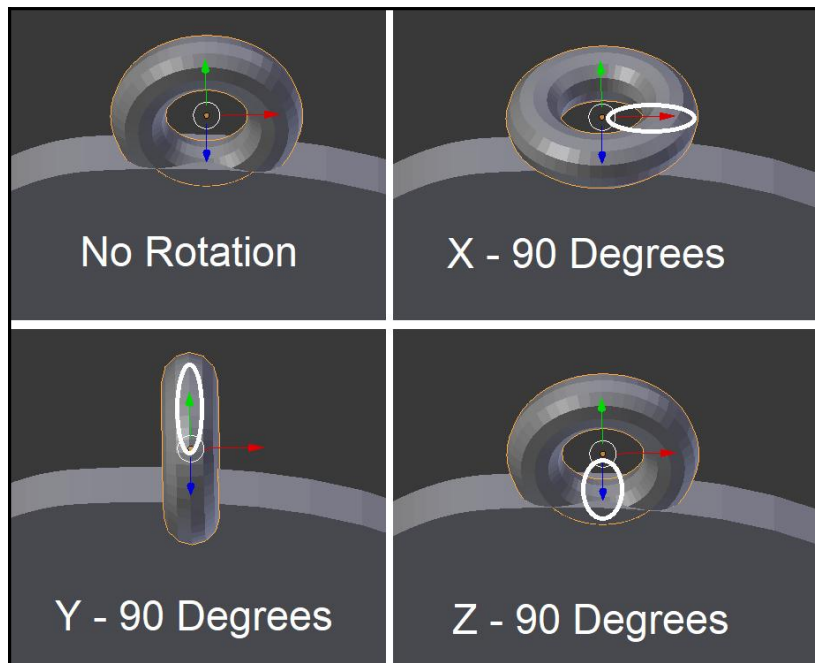
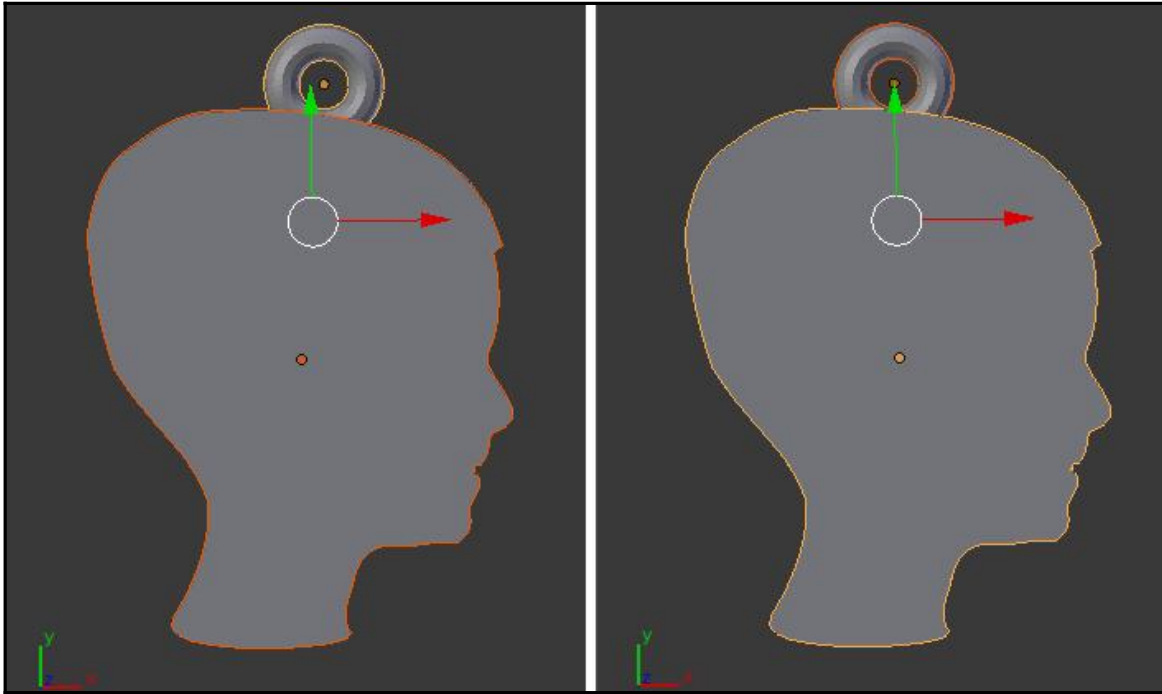

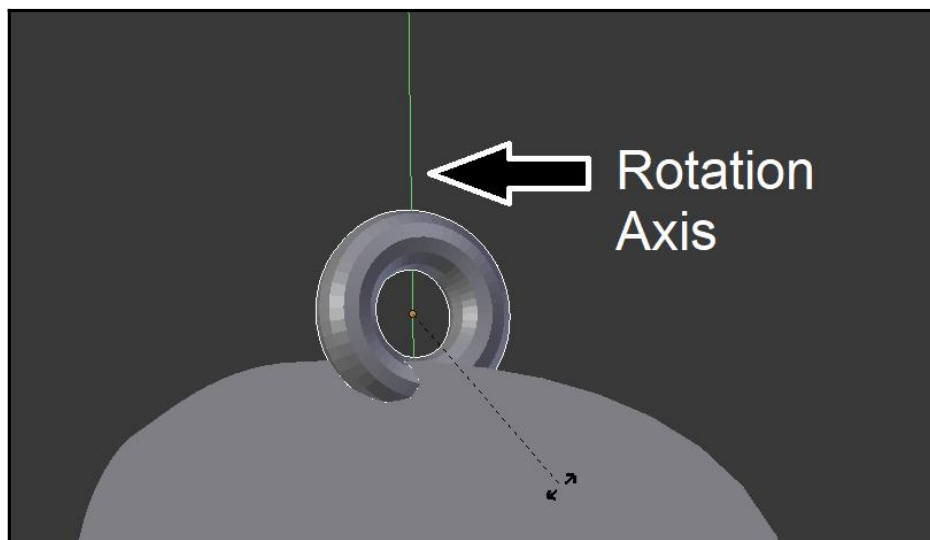
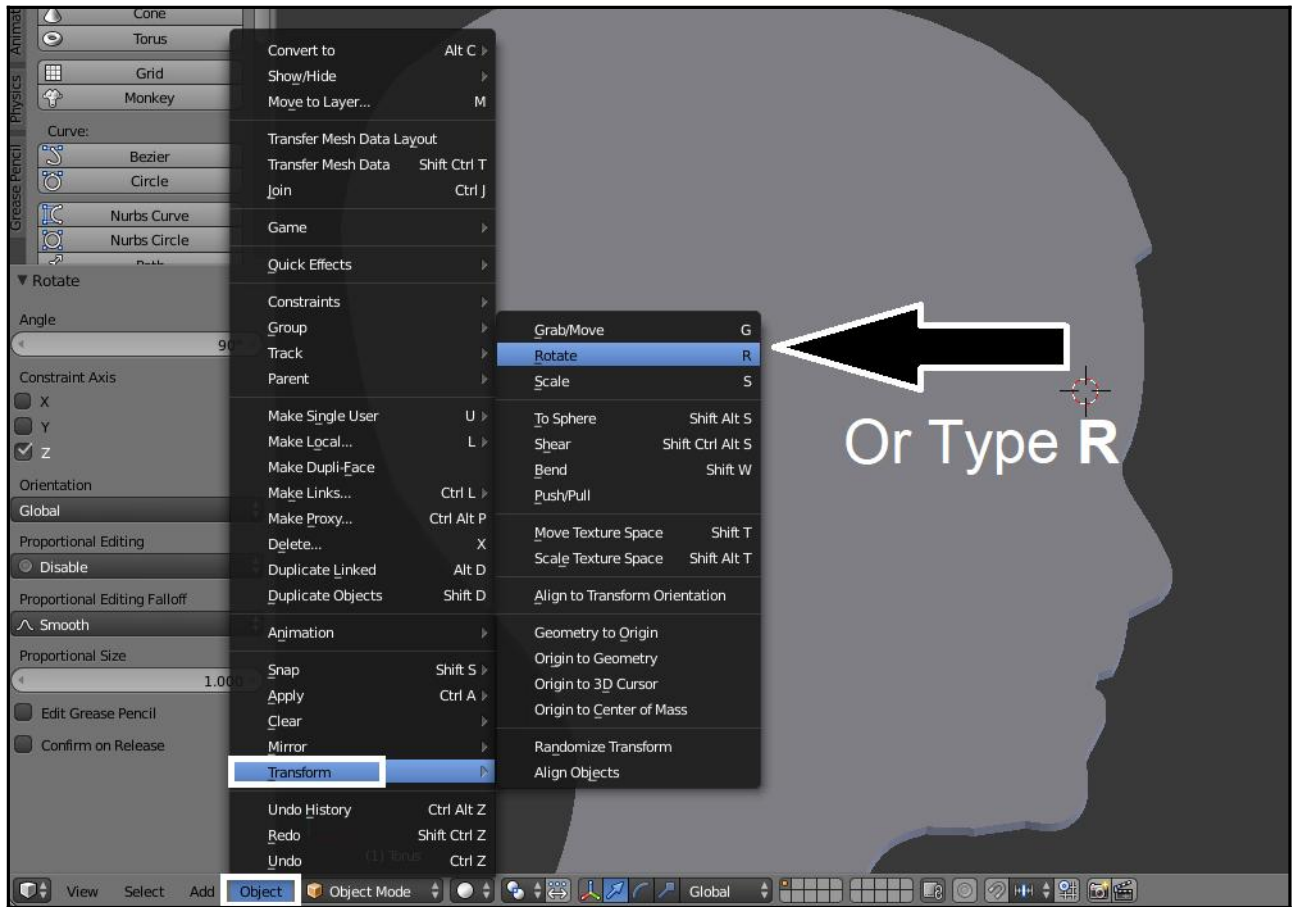

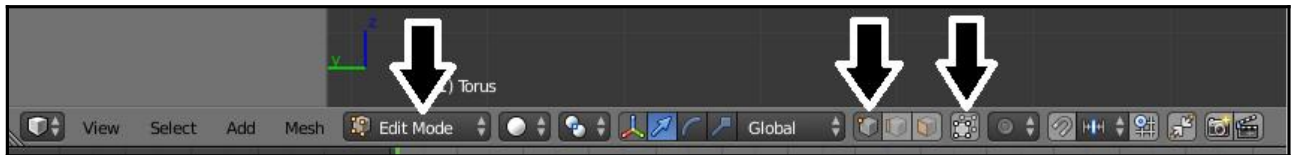
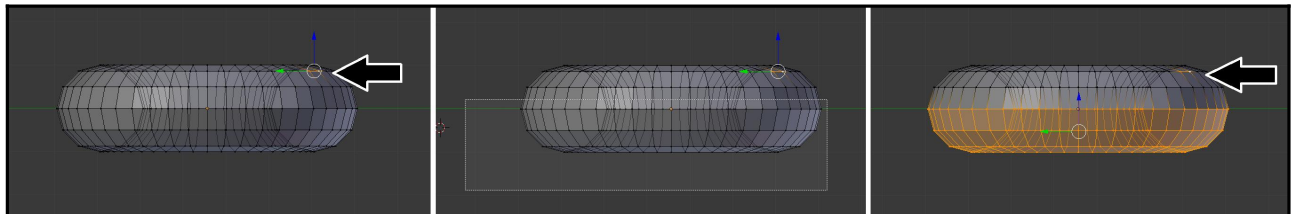
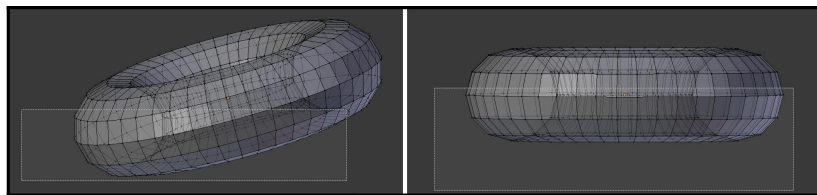
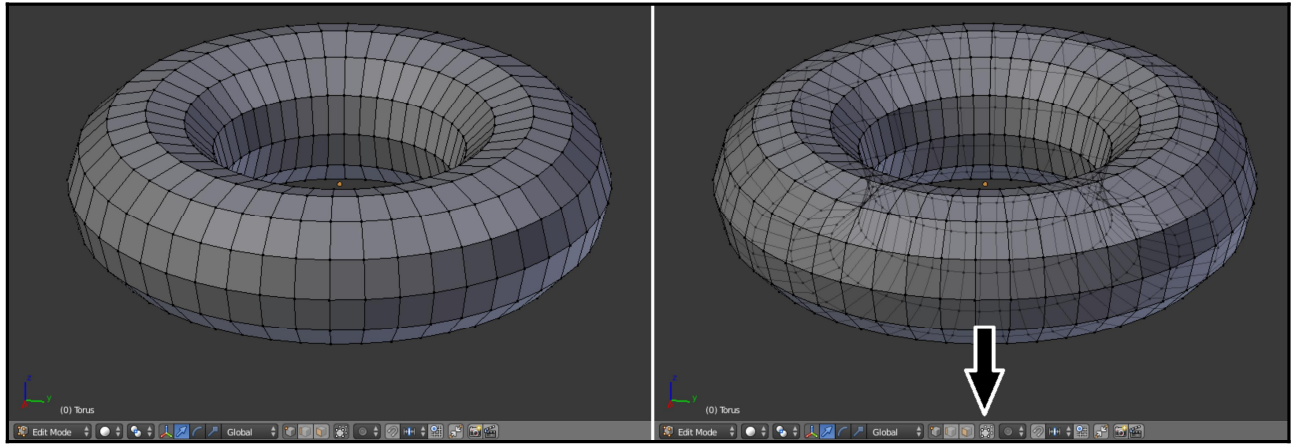
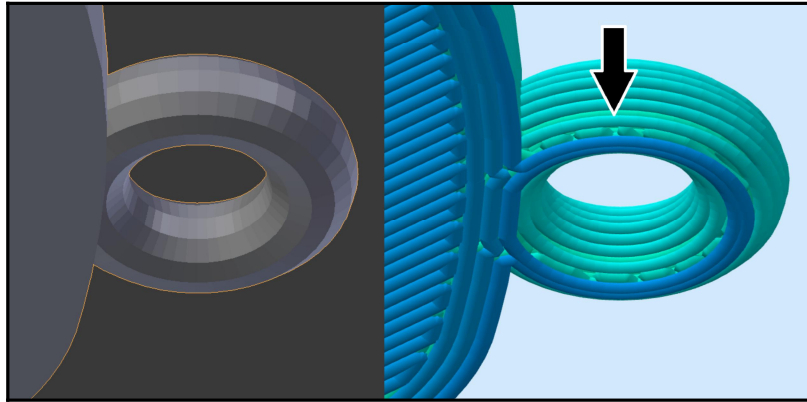



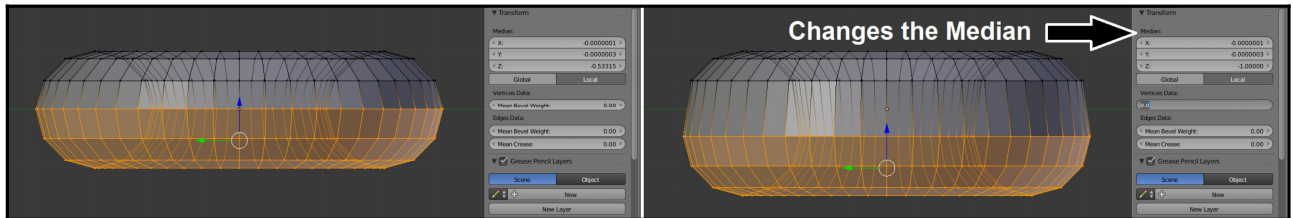
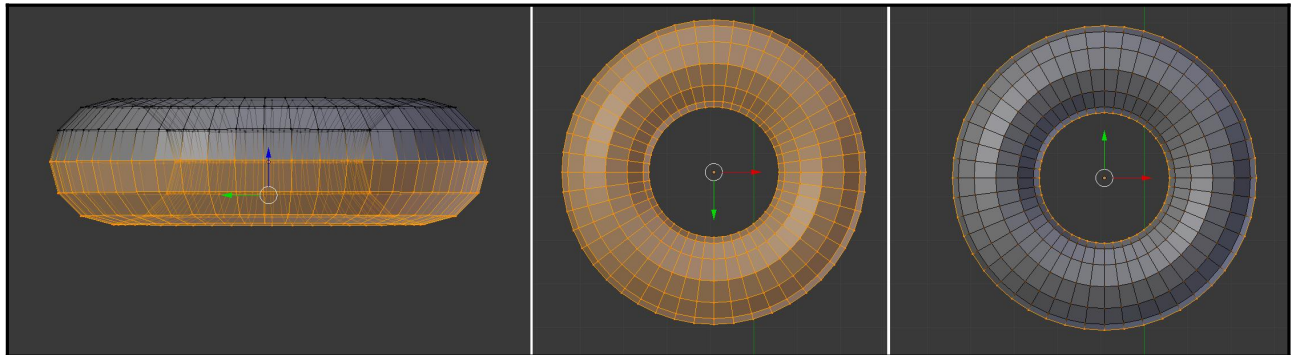
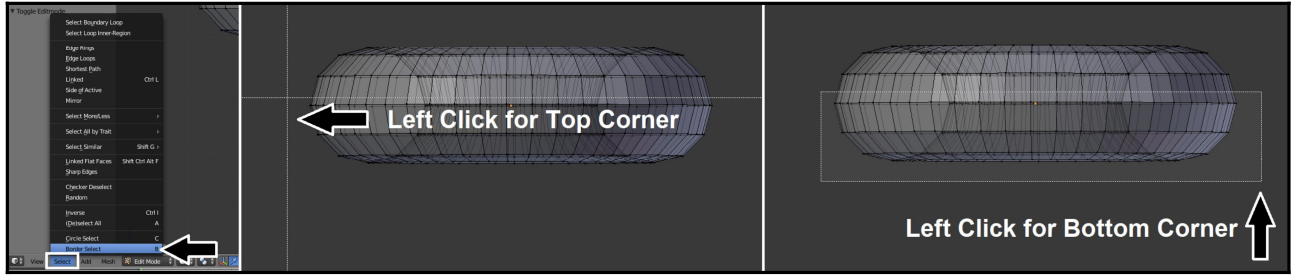

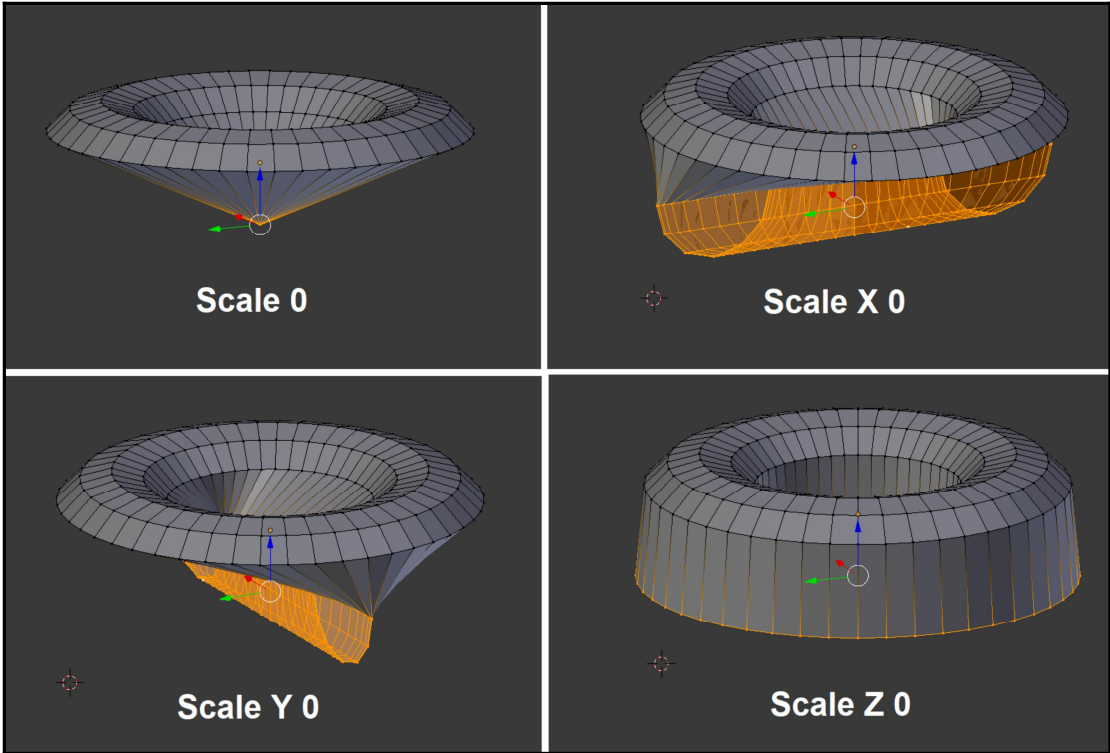

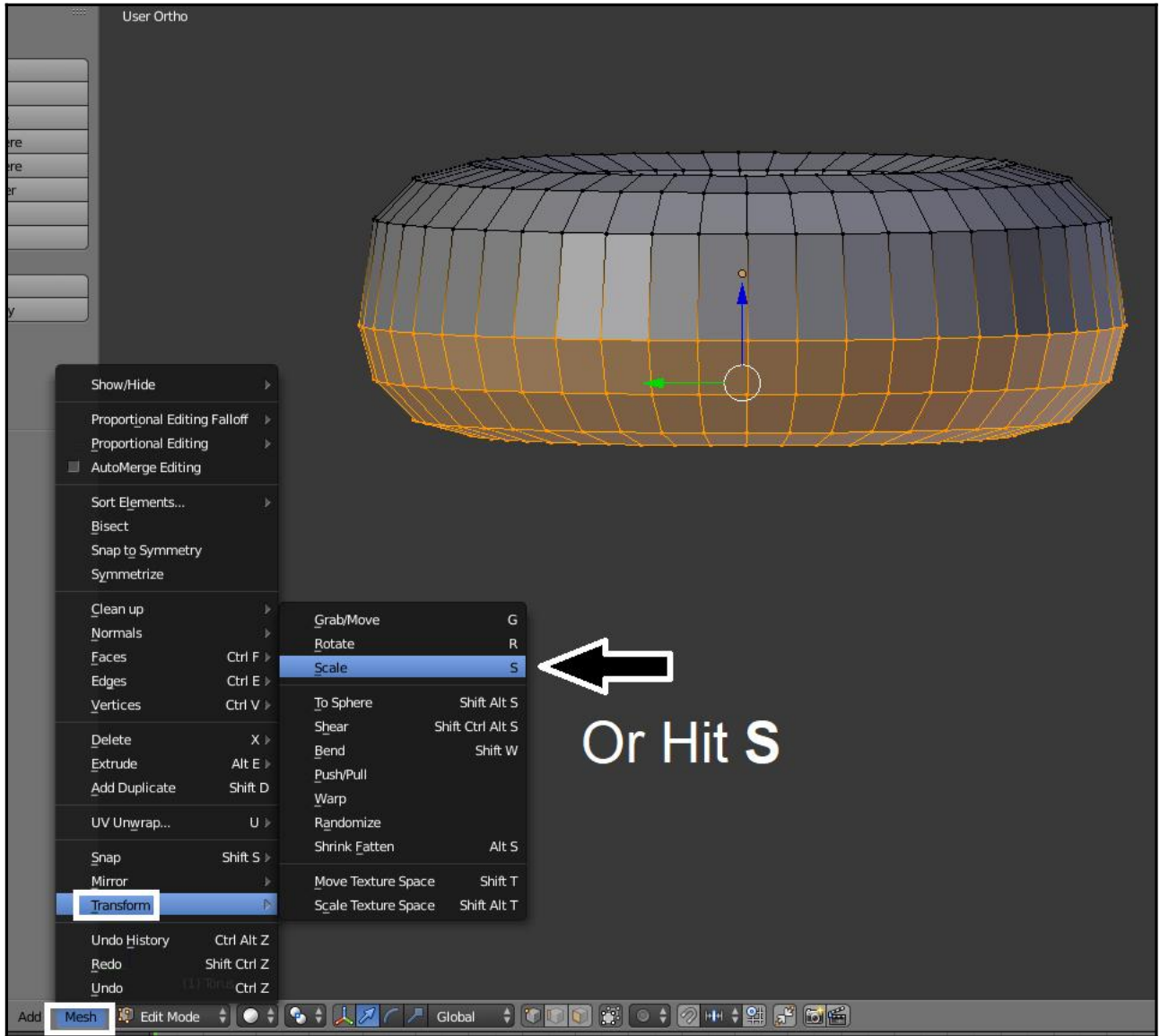

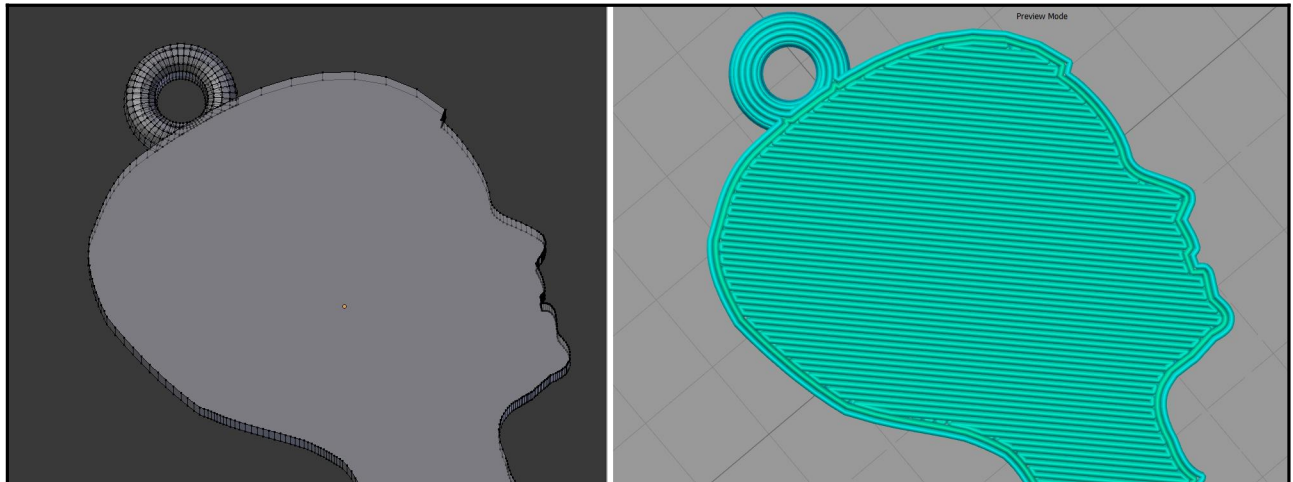
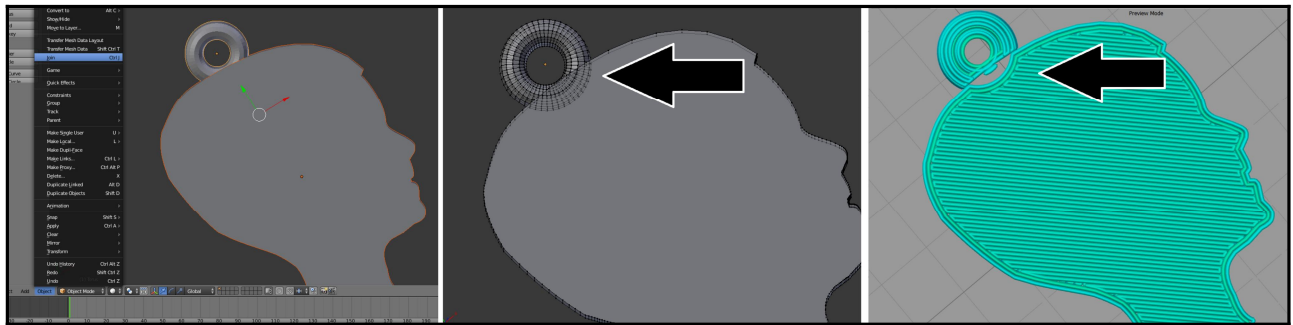
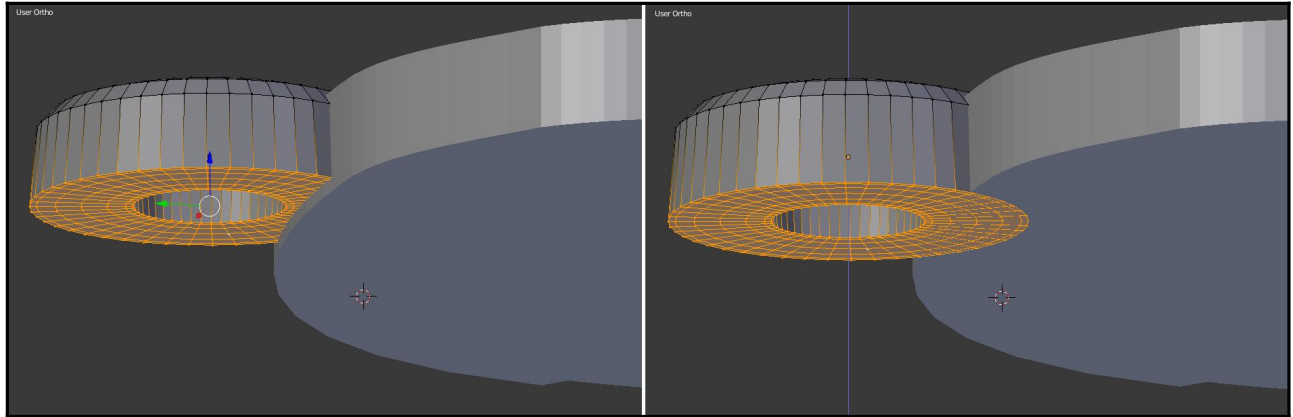

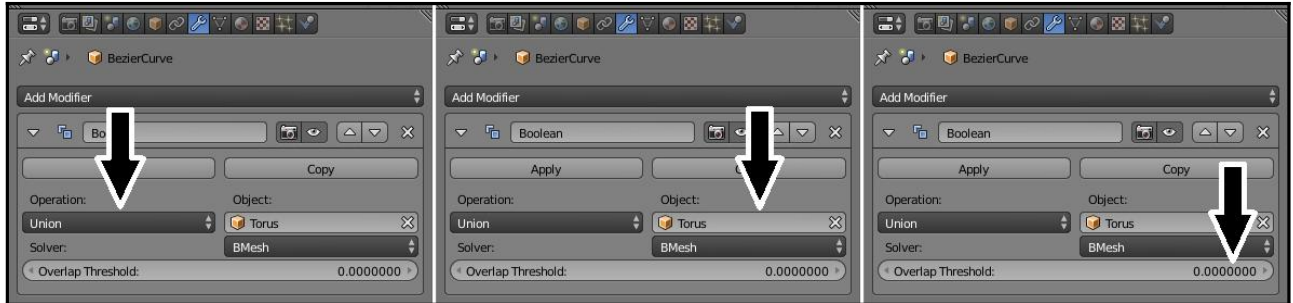
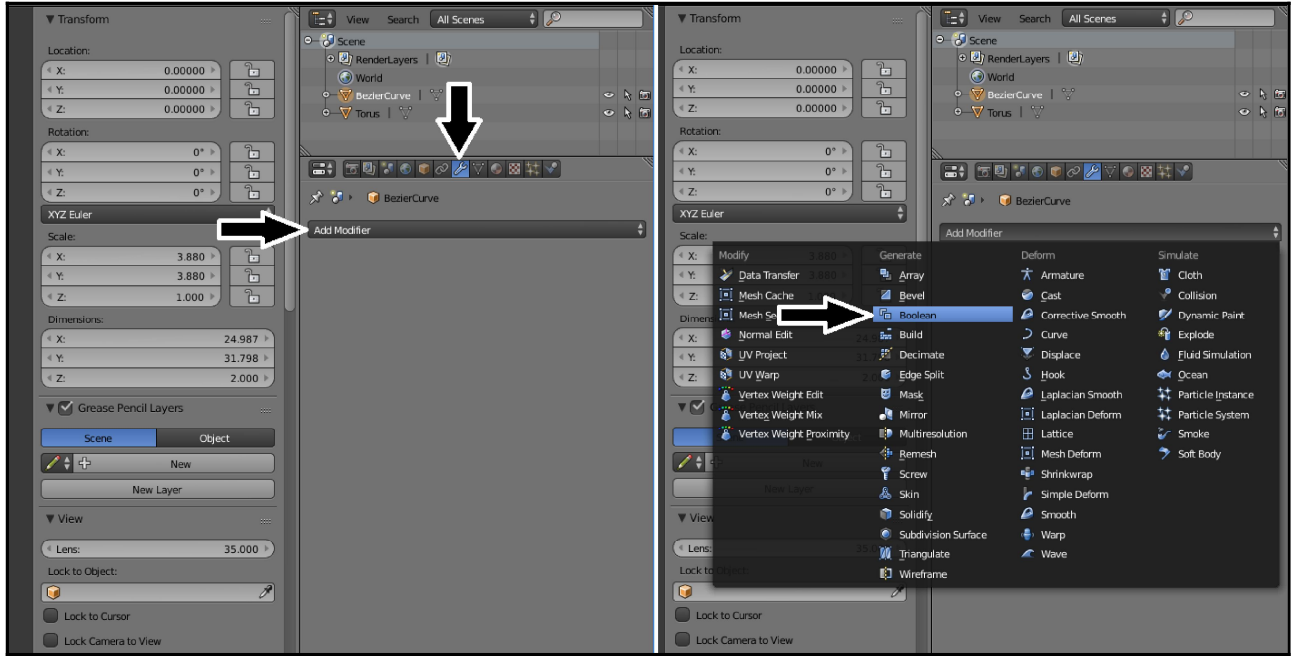

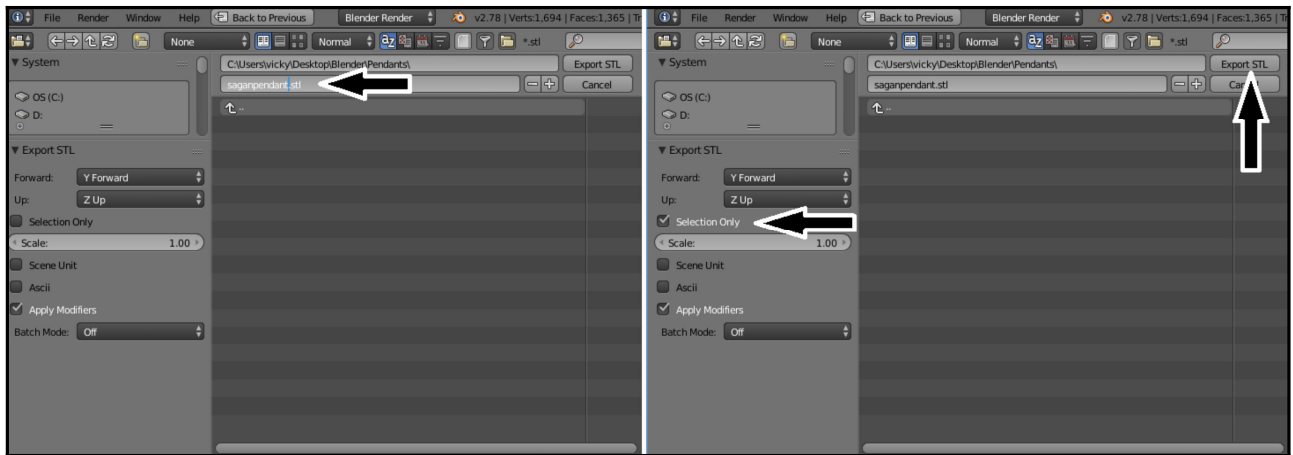
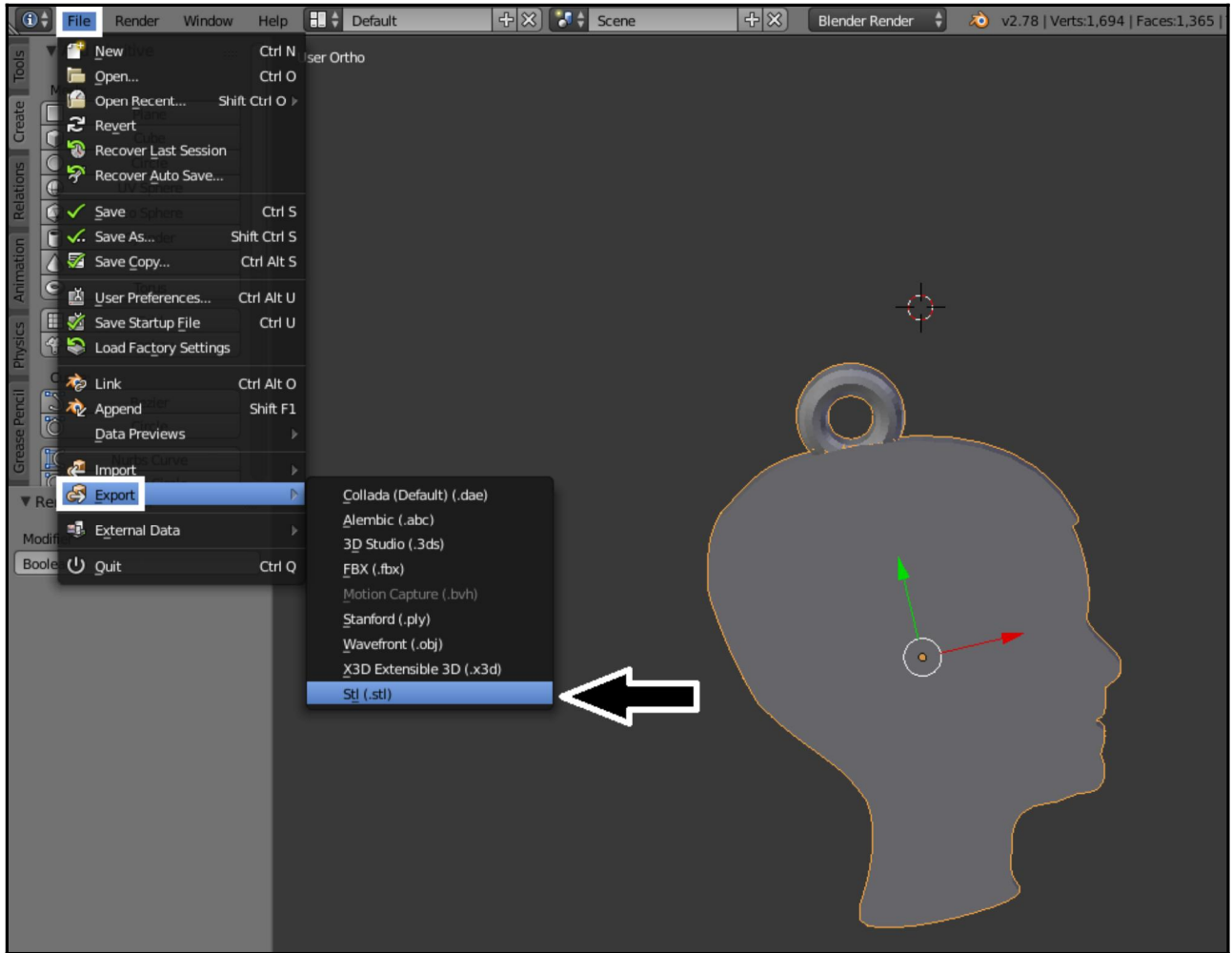

# Chapter 5: Building a Base with Standard Meshes and a Mirror

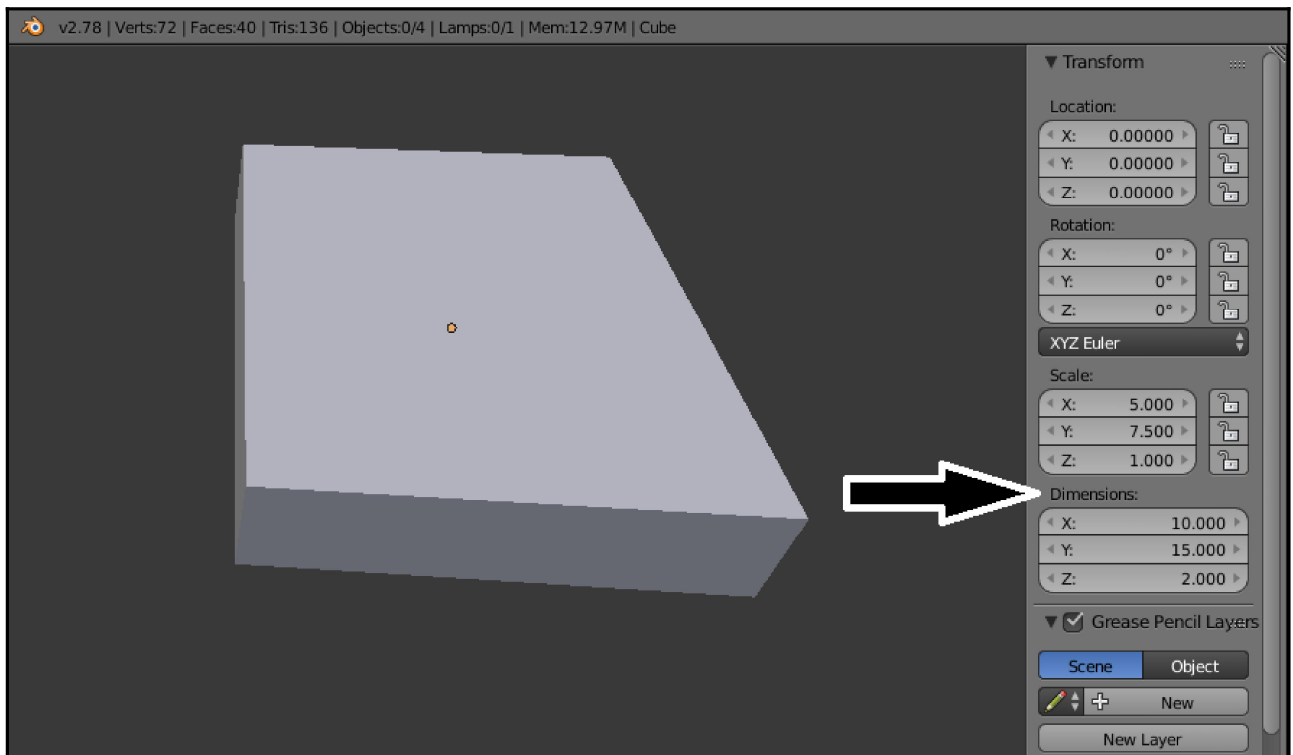
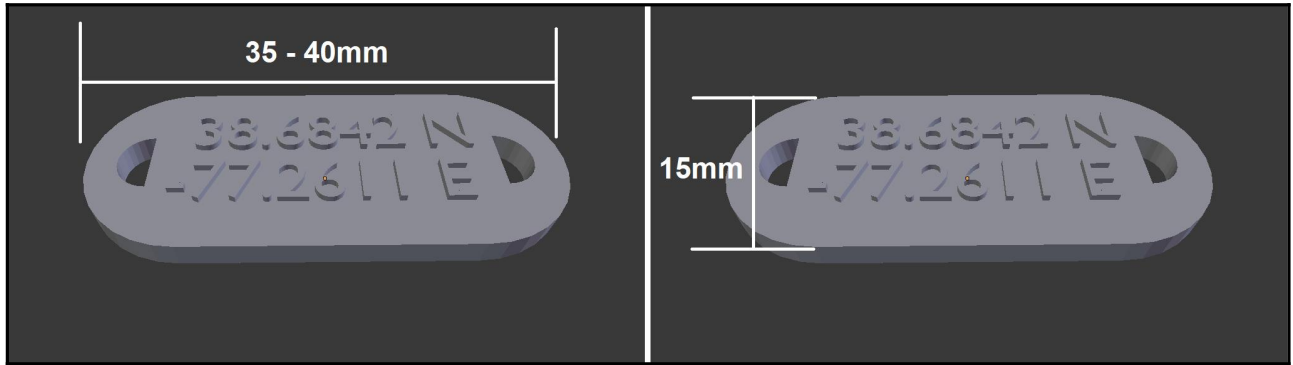

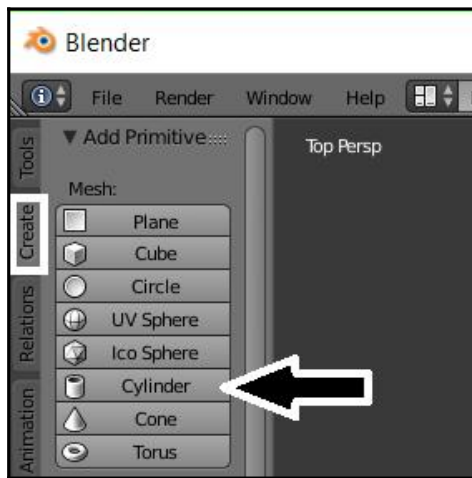
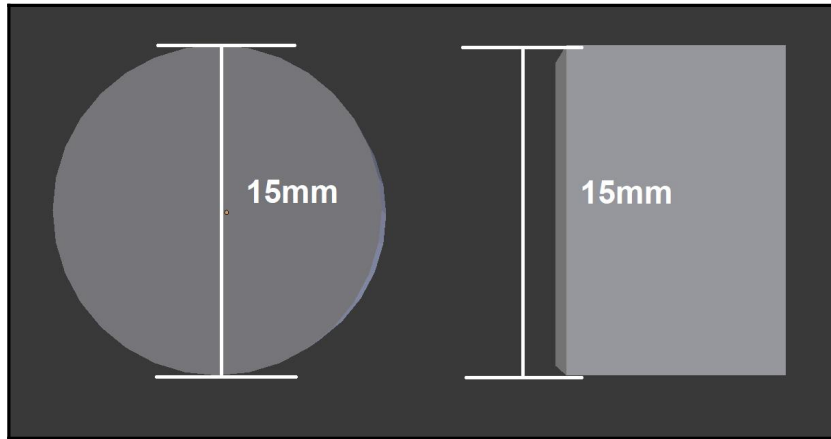



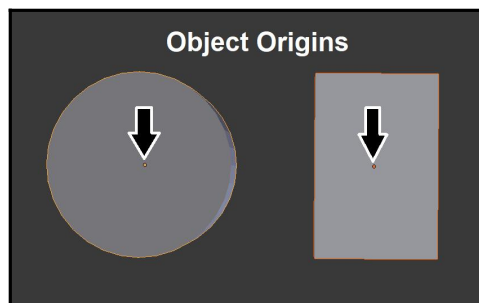
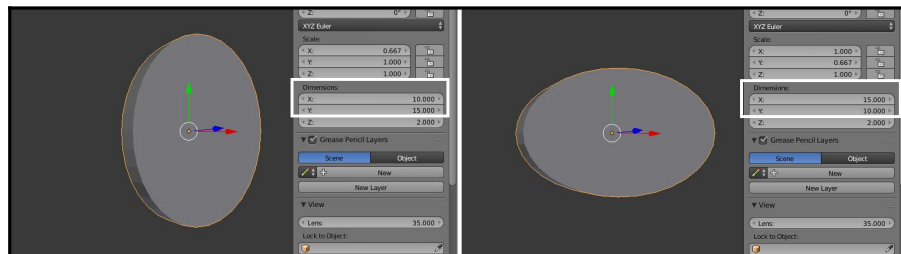
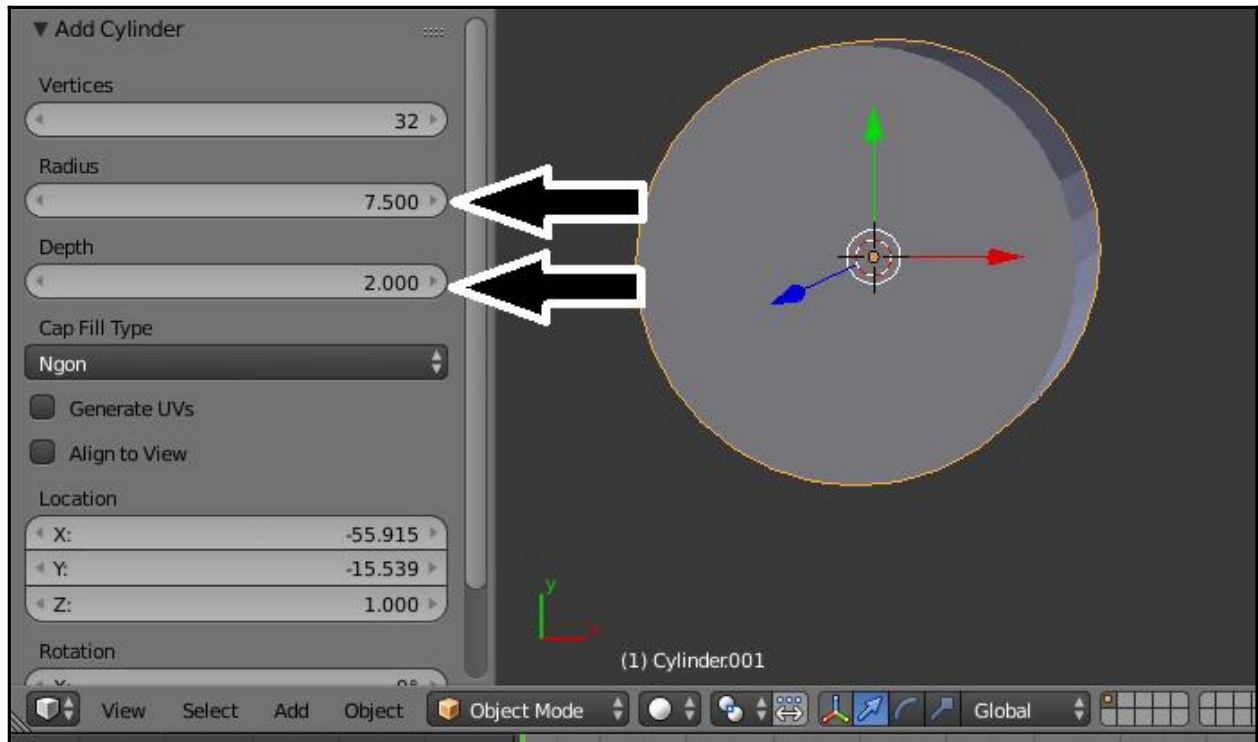

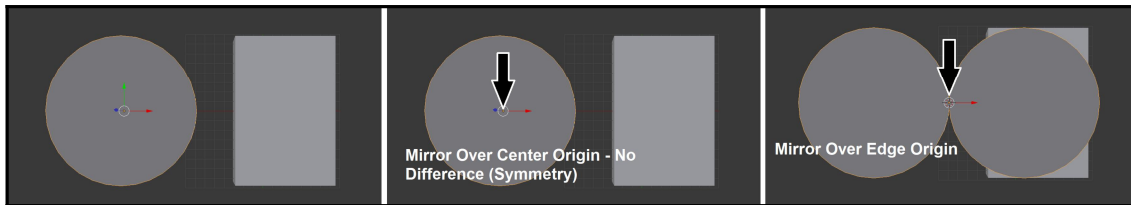
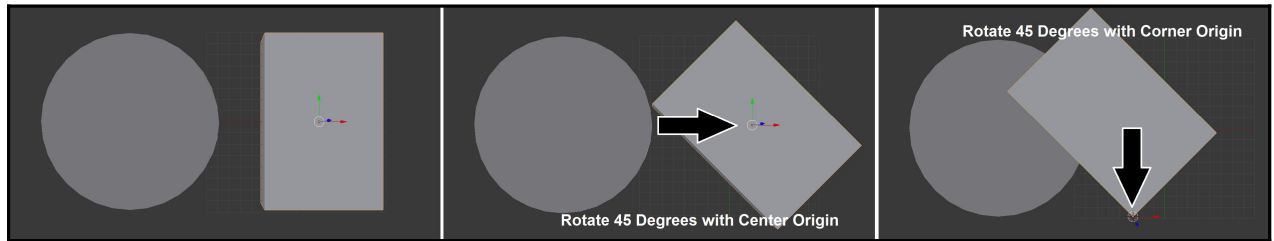
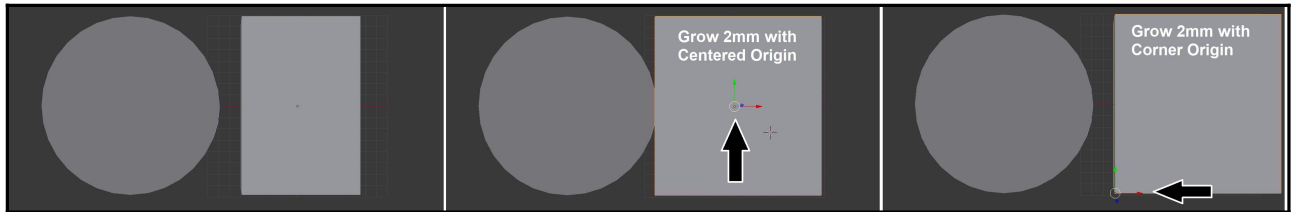

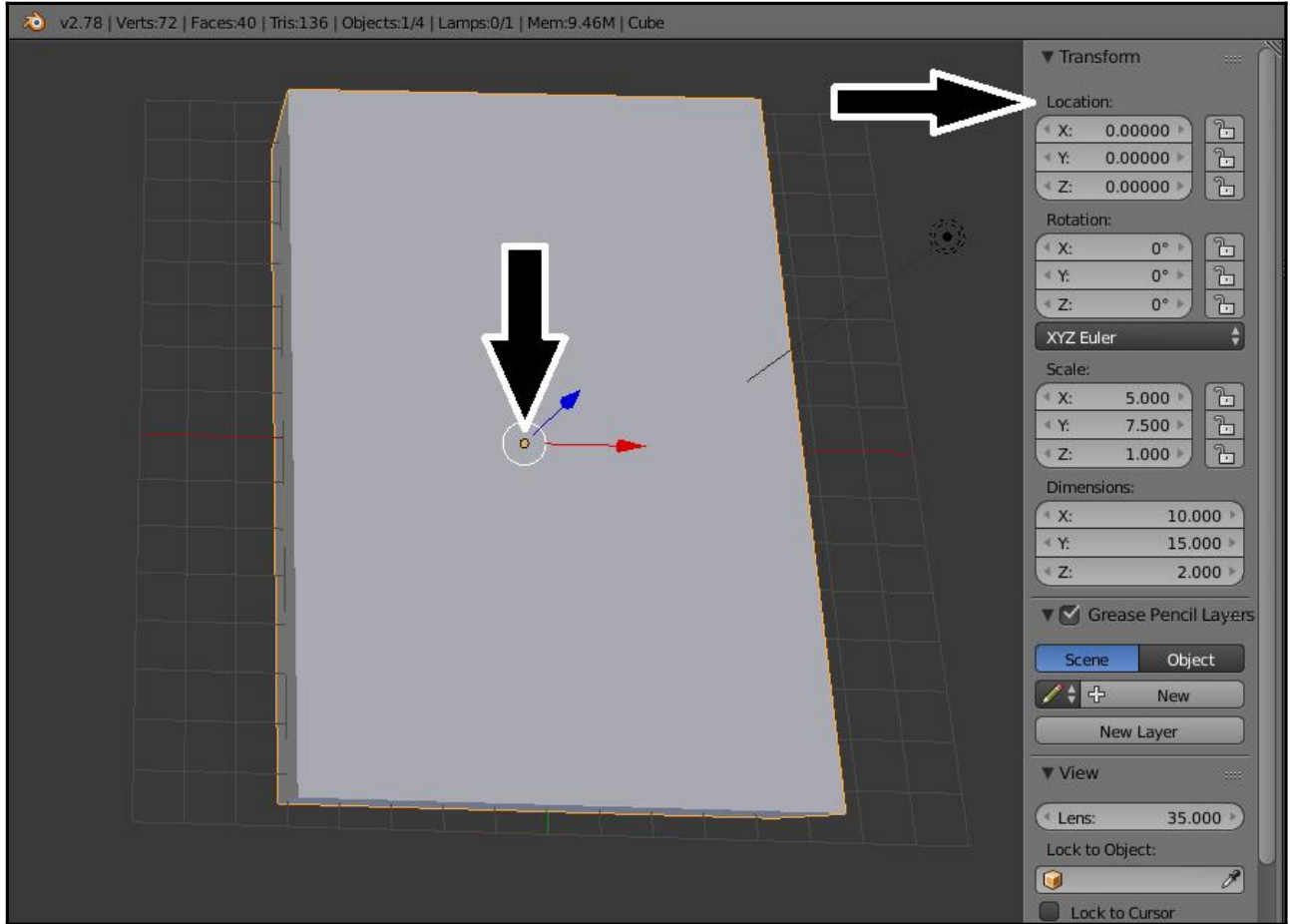

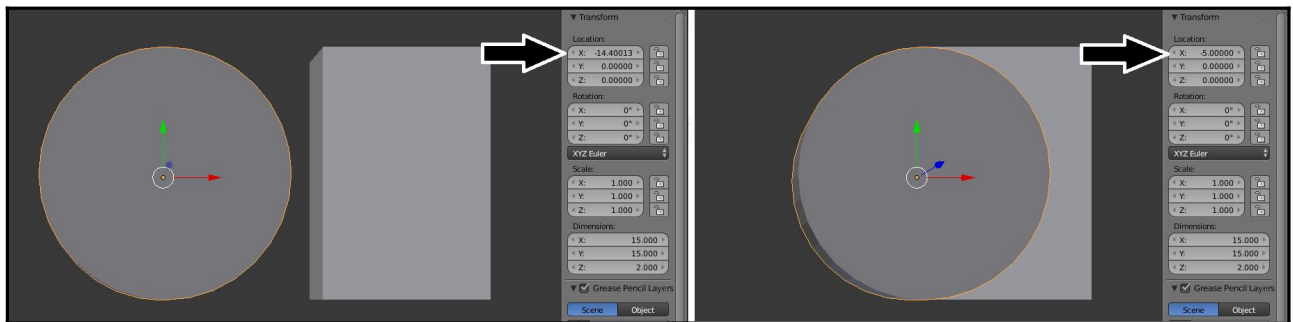
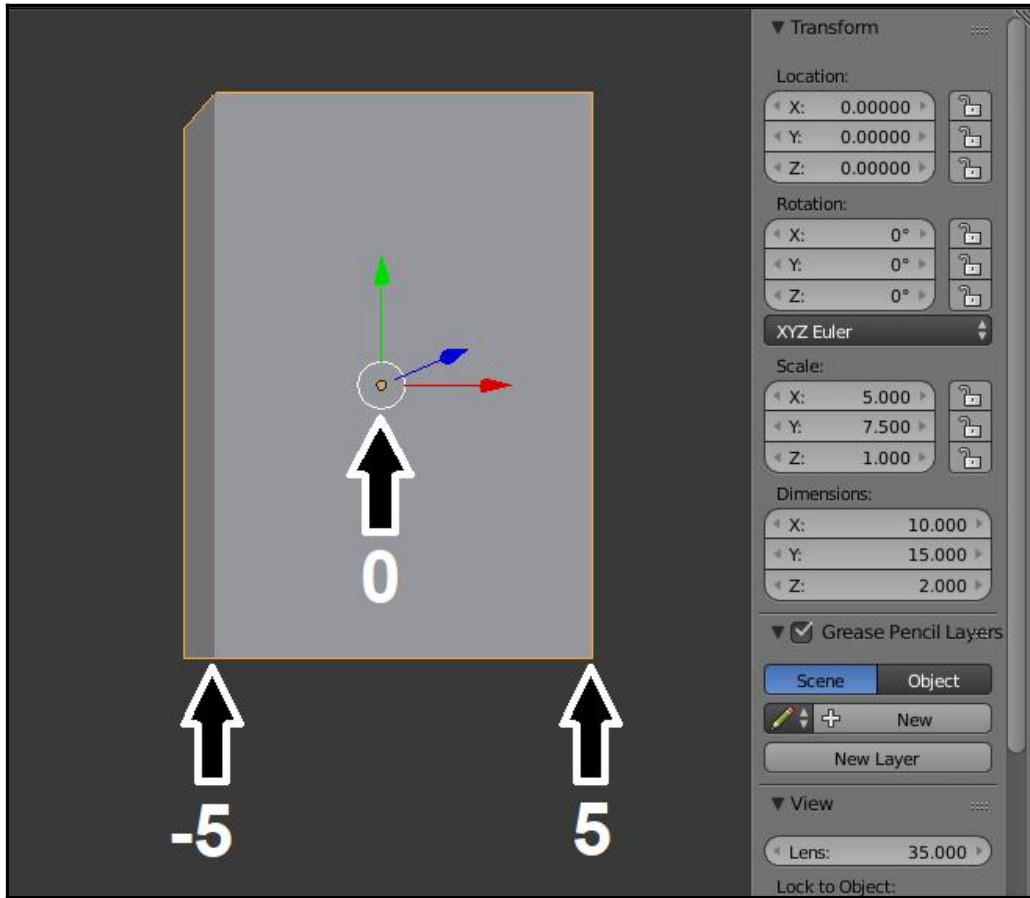

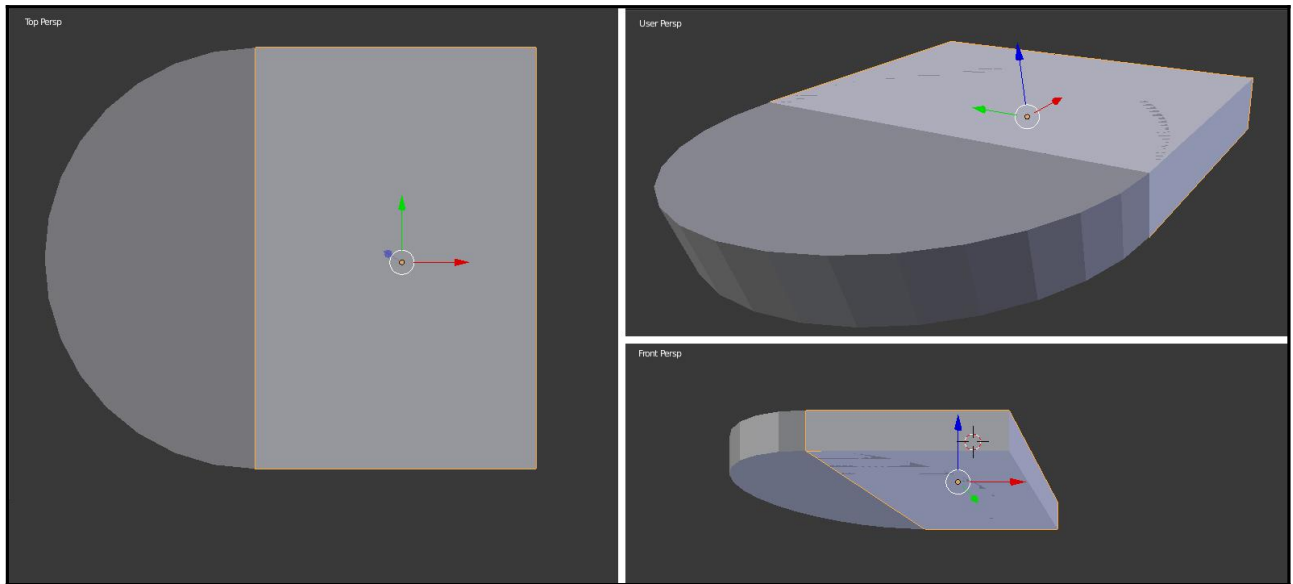
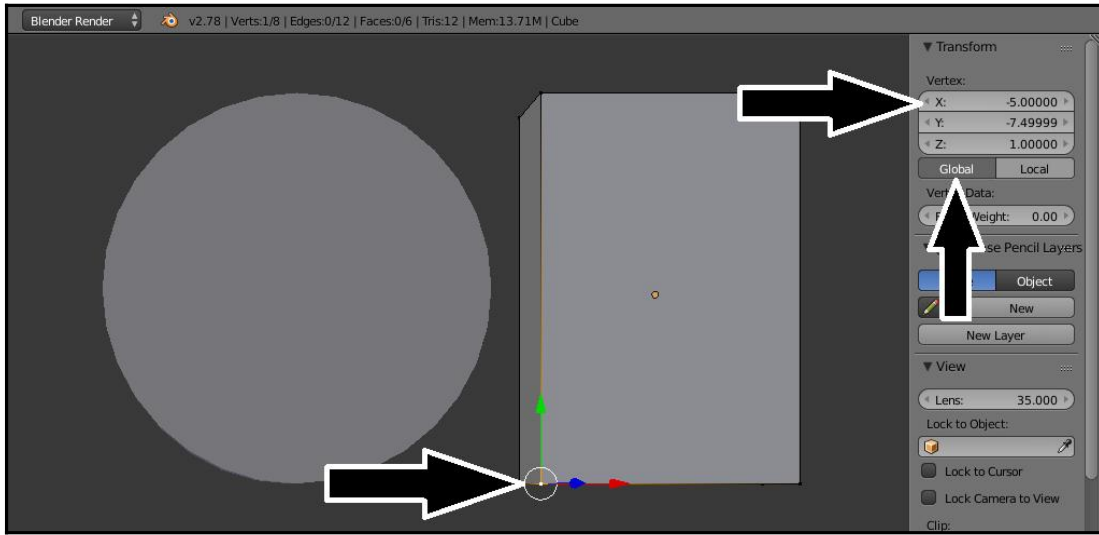

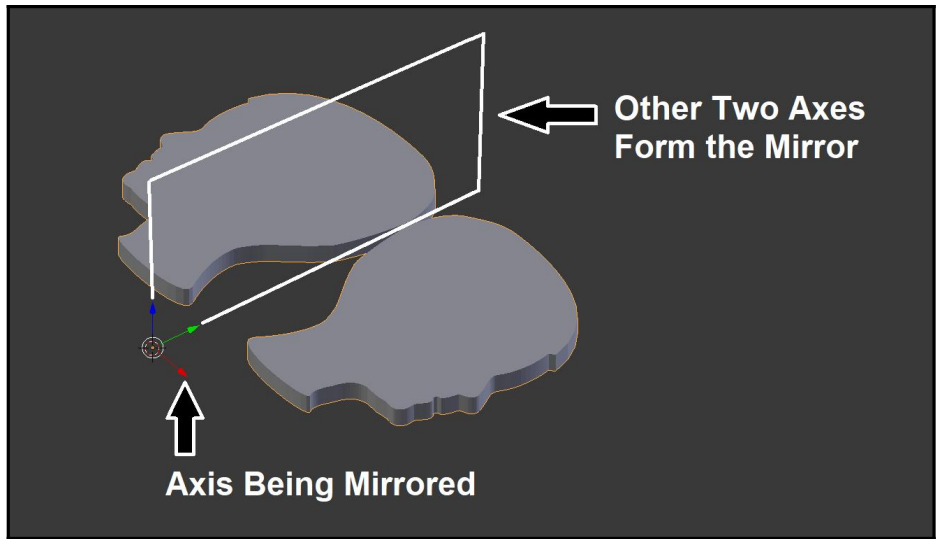
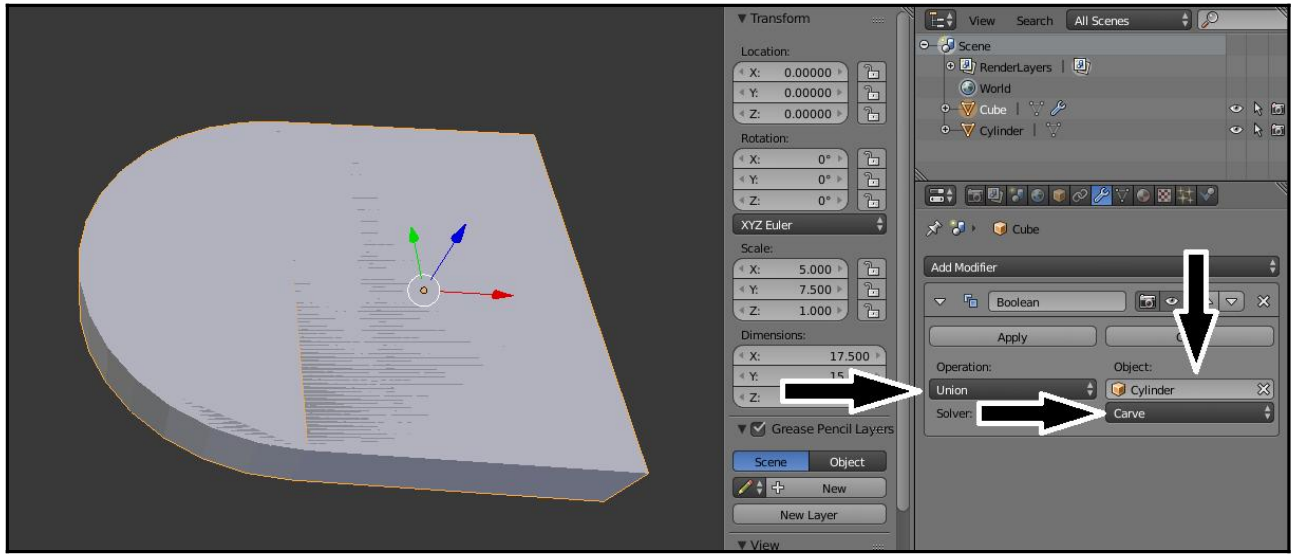

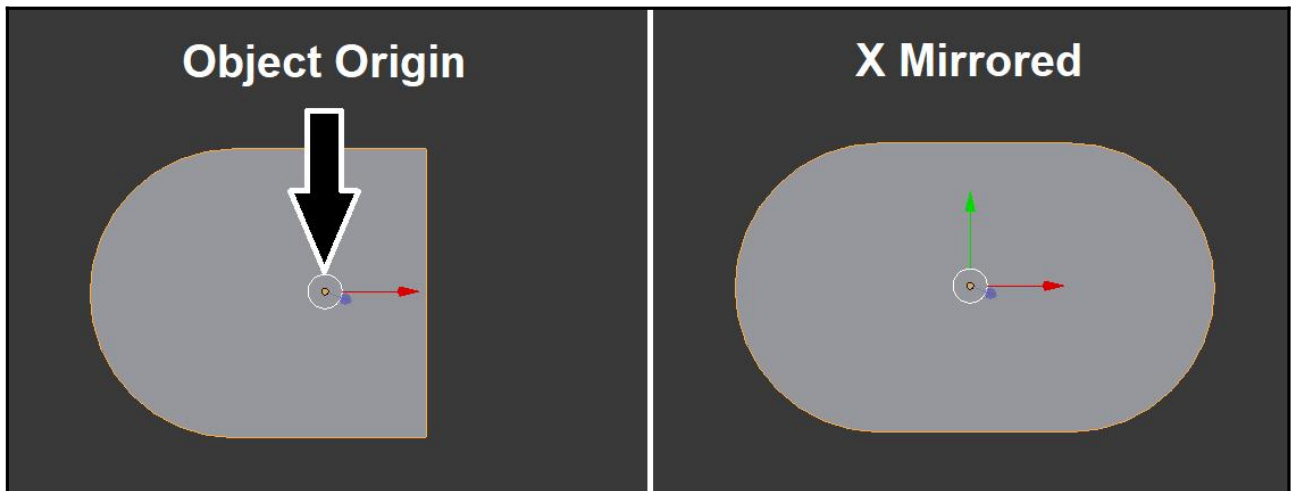
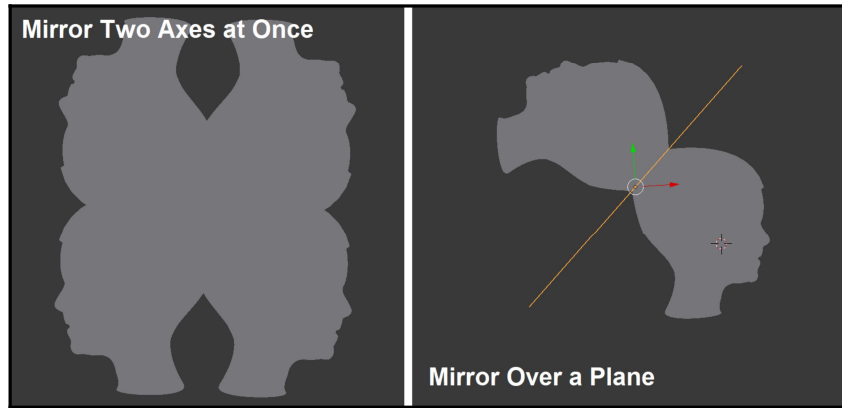

**Object Origin**

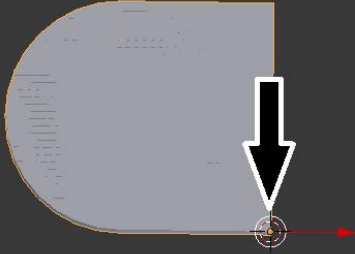

**X Mirrored**





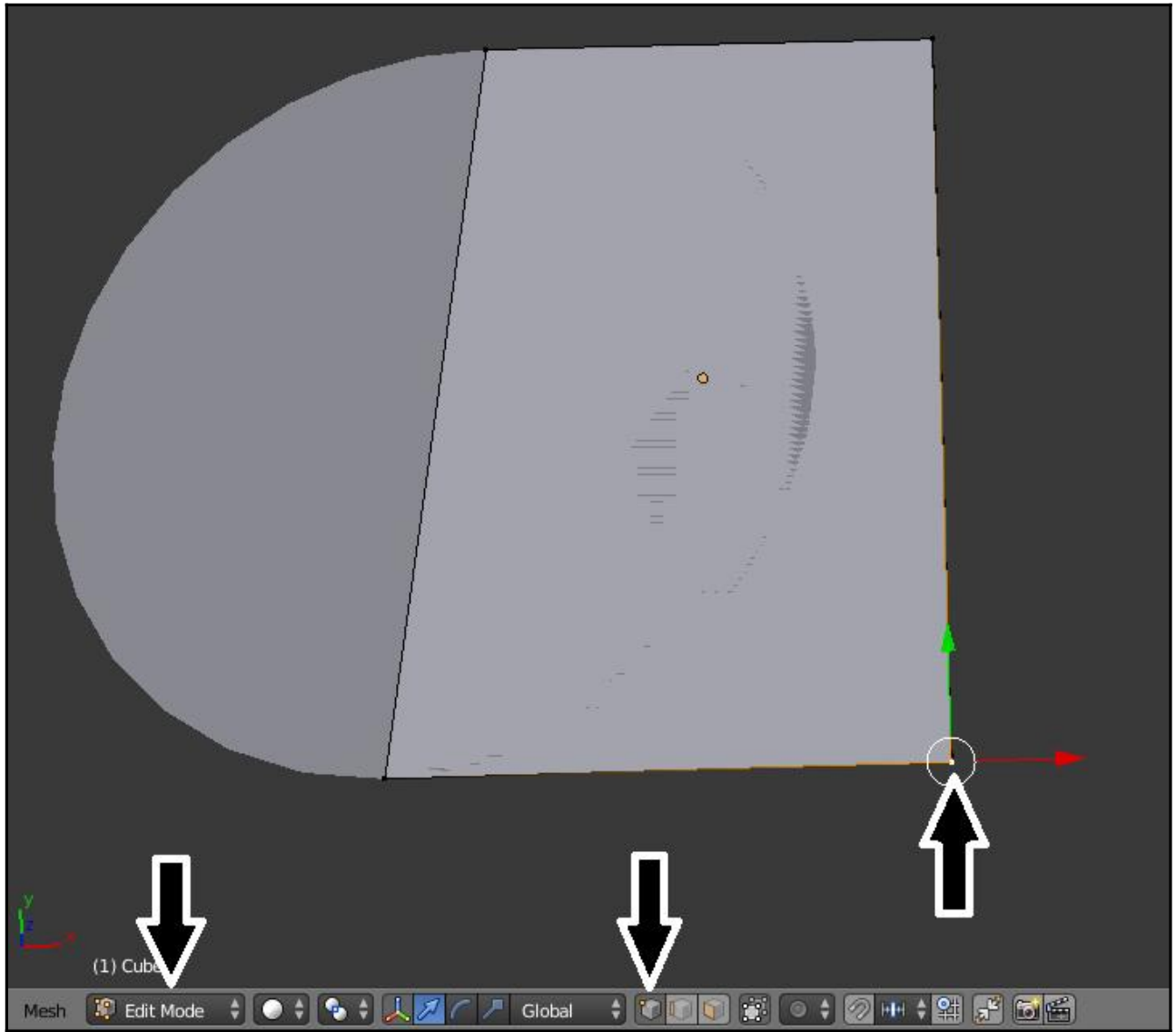

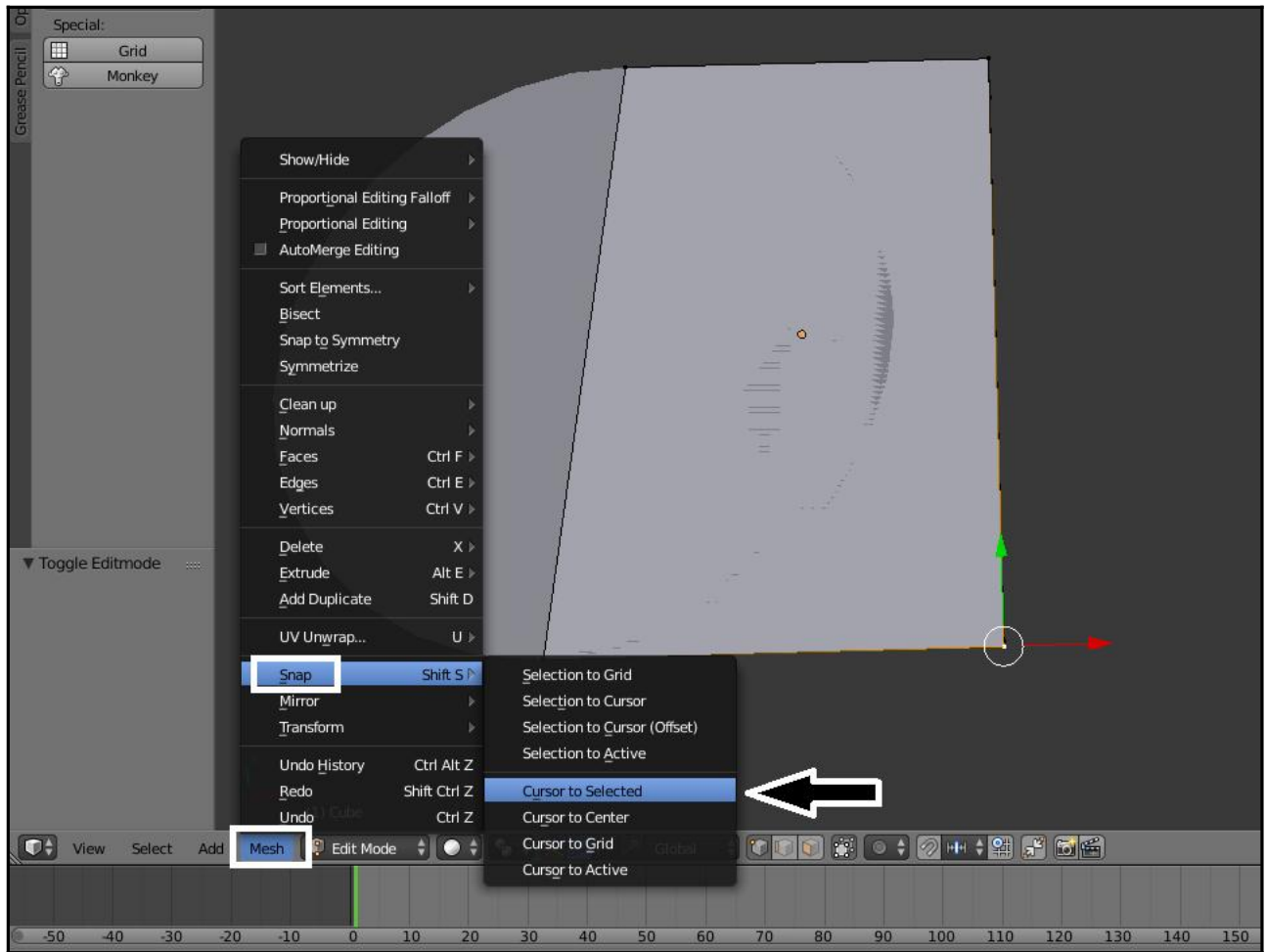

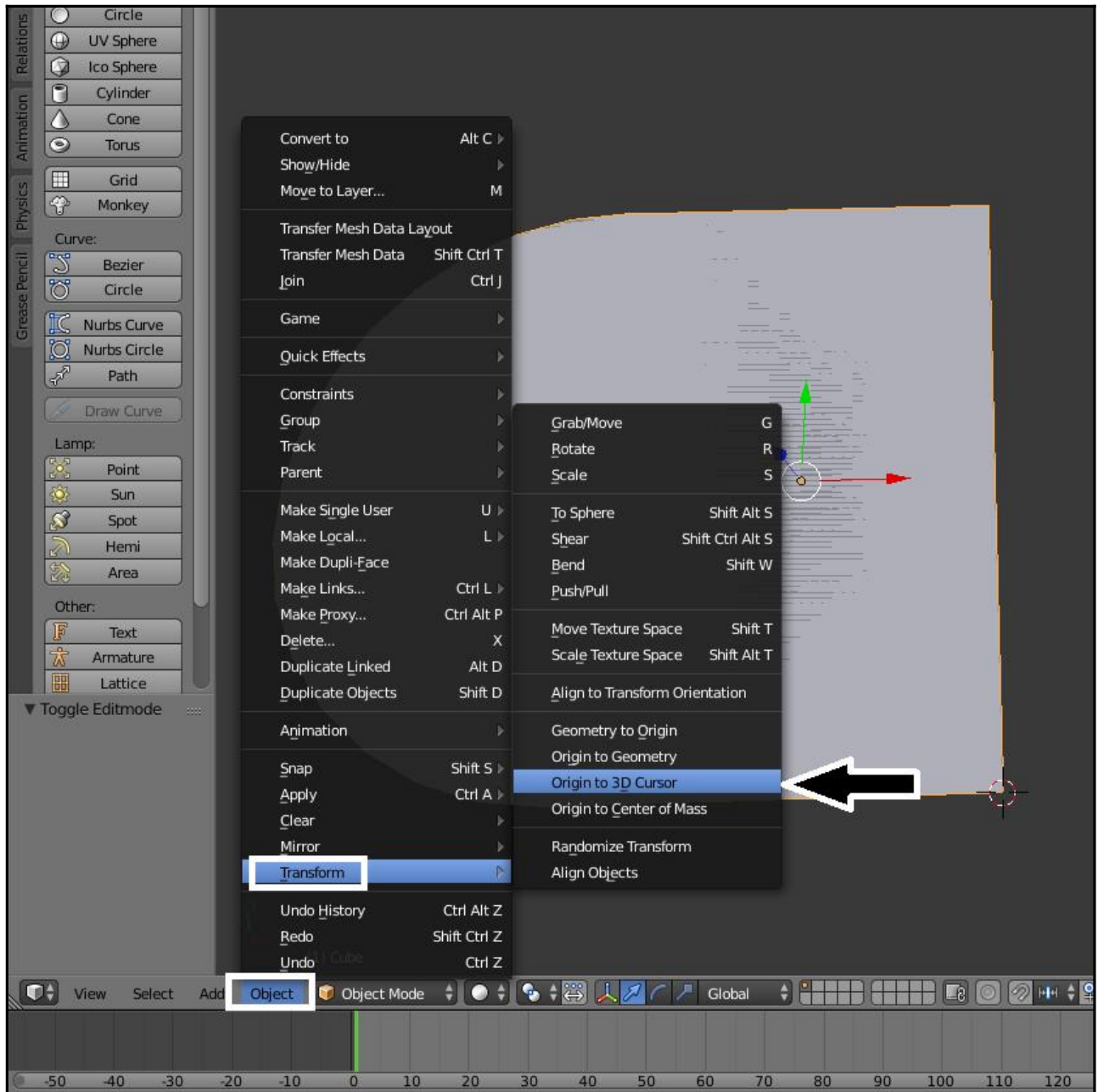

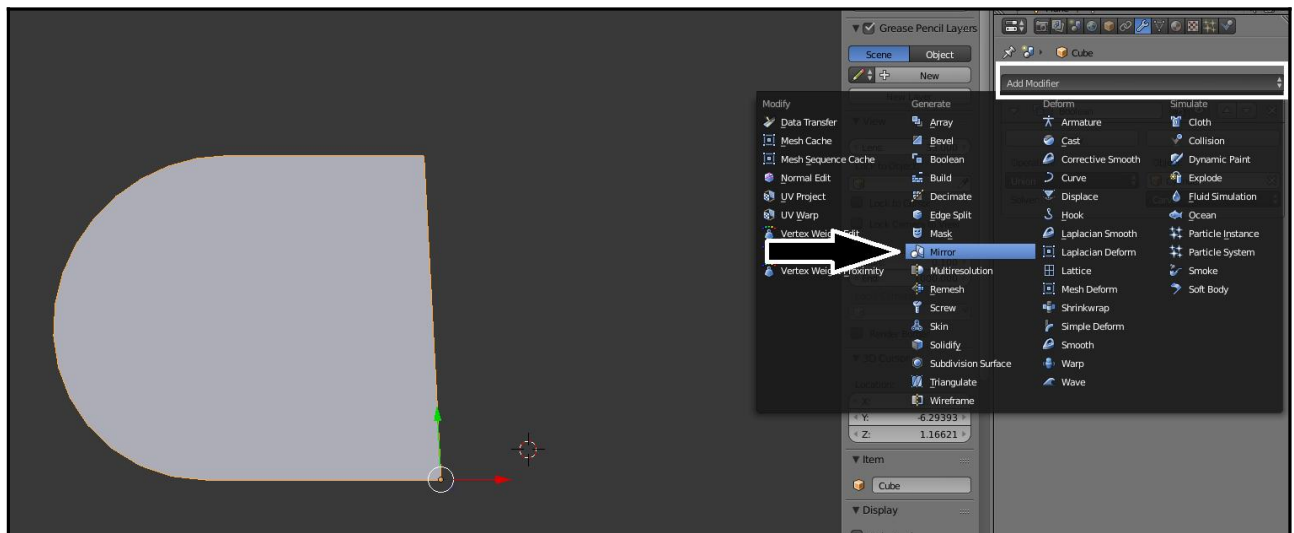
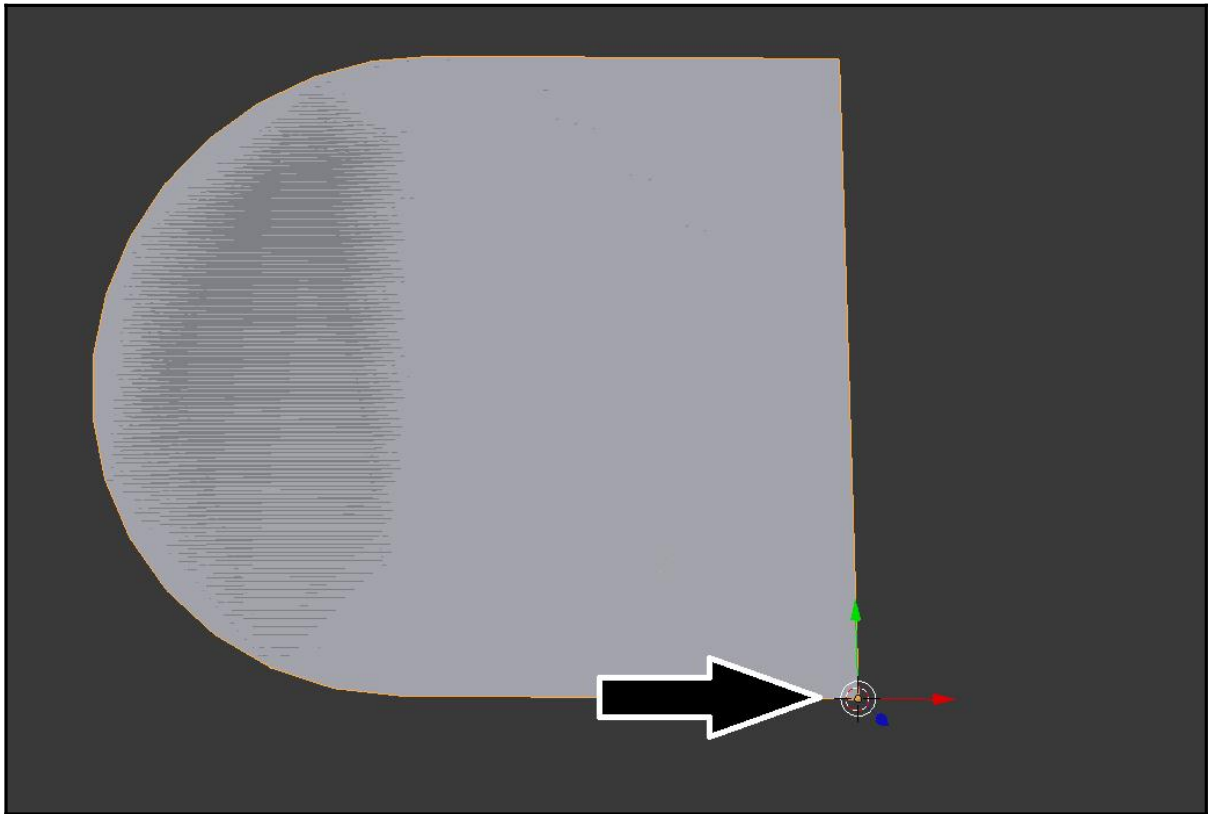

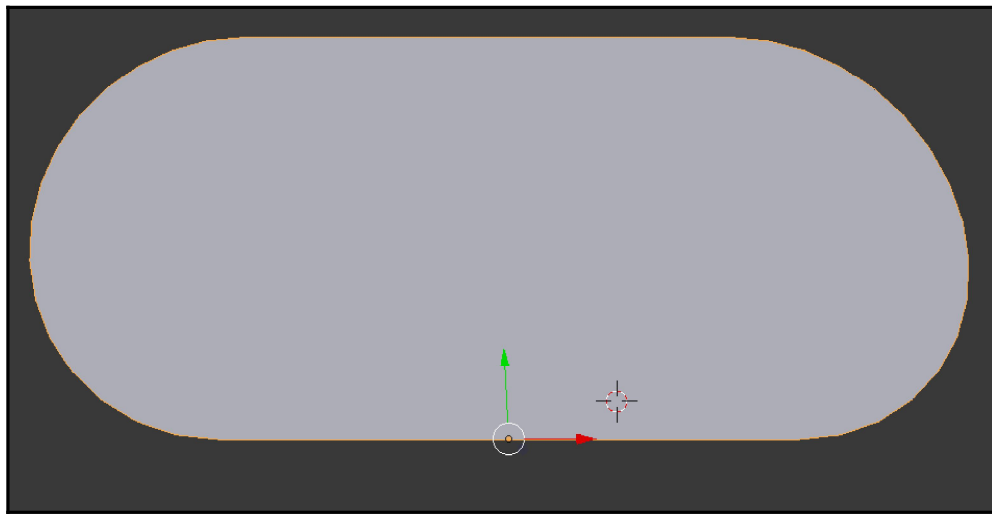
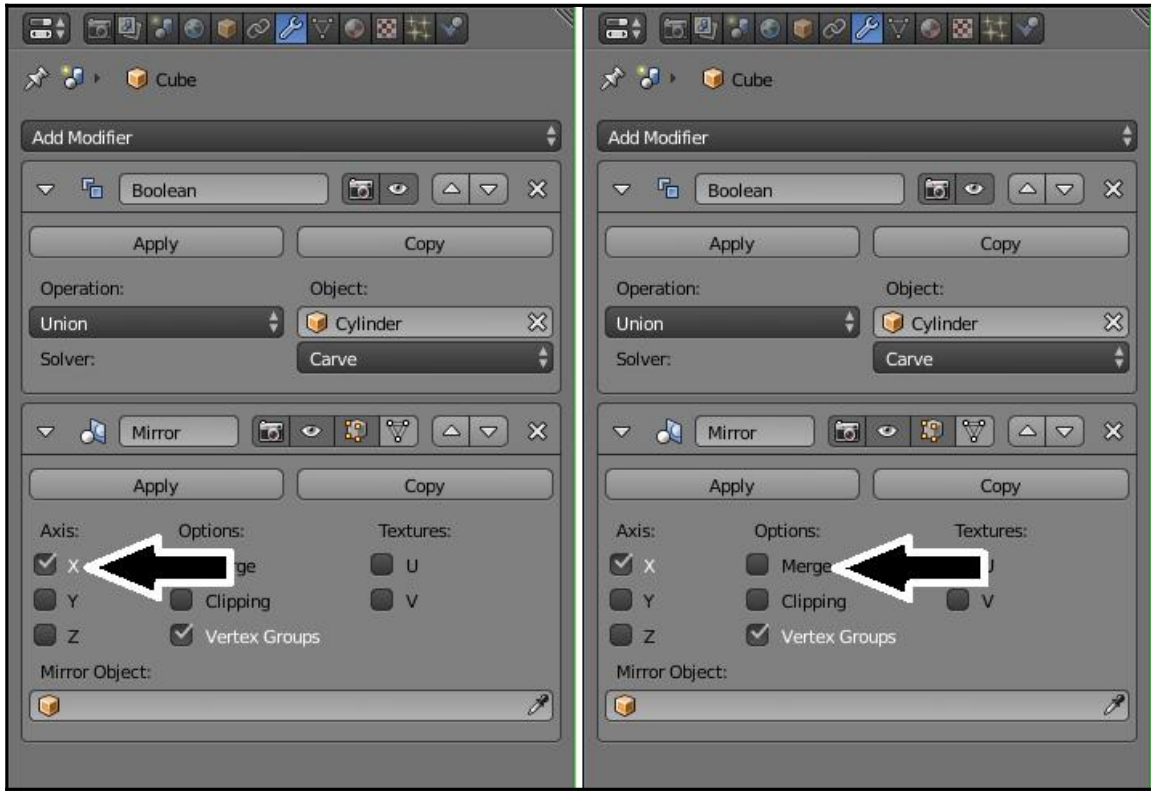

# Chapter 6: Cutting Half Circle Holes and Modifier Manag ement

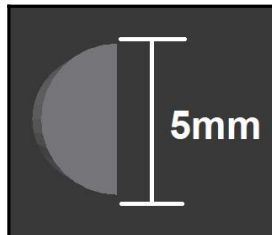
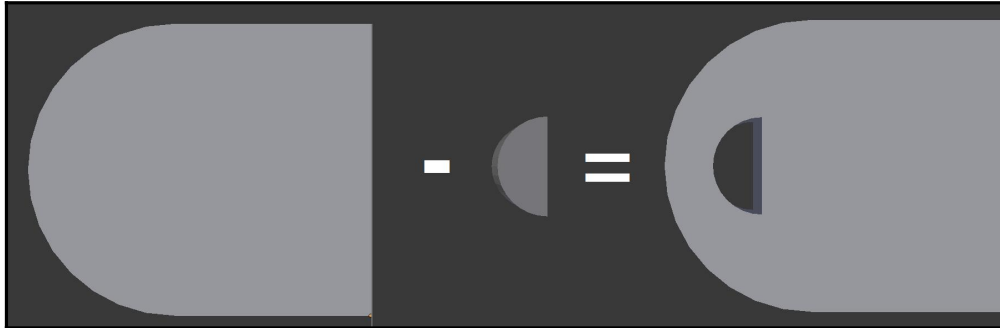

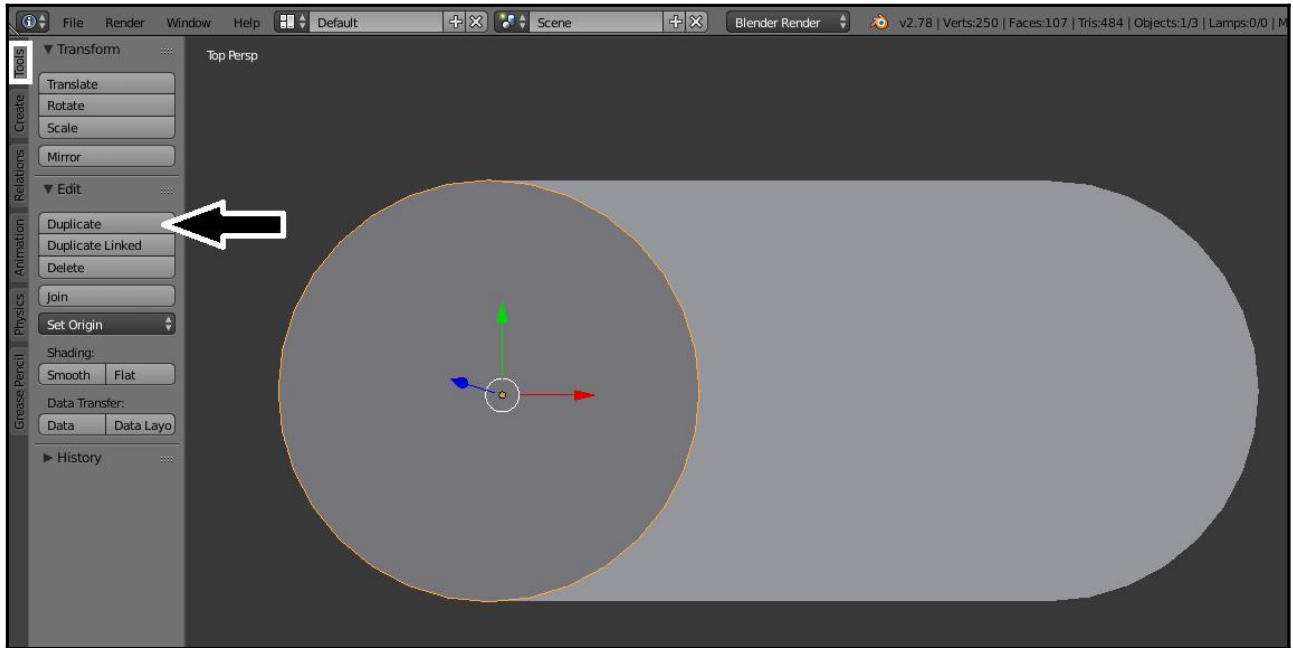

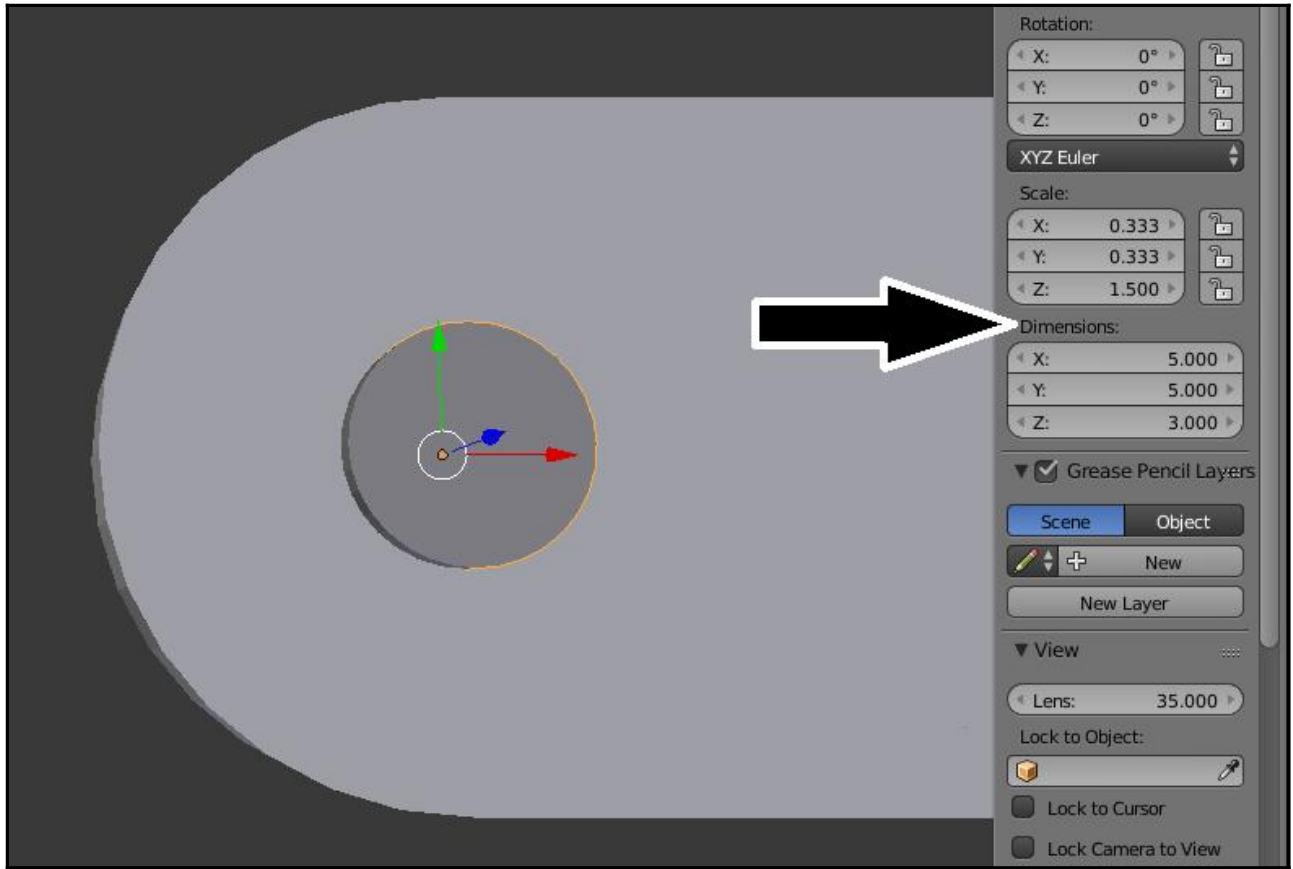



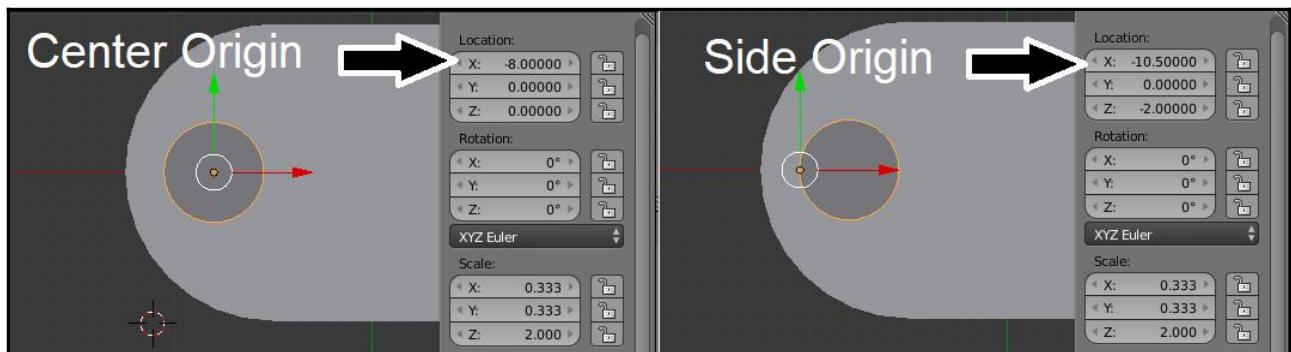
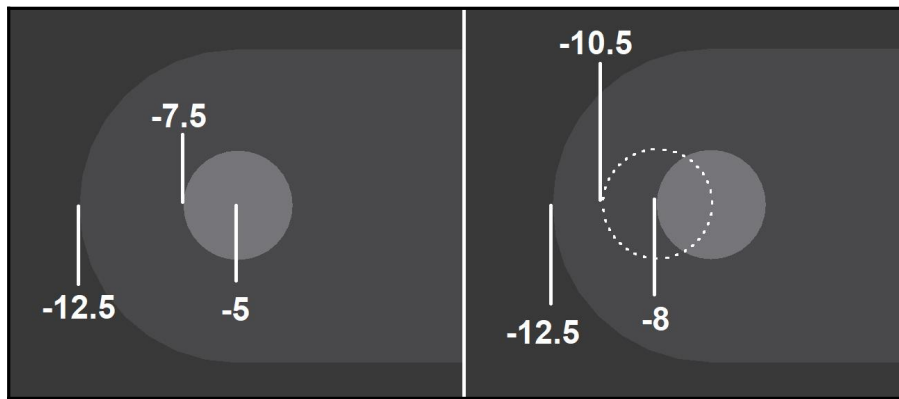

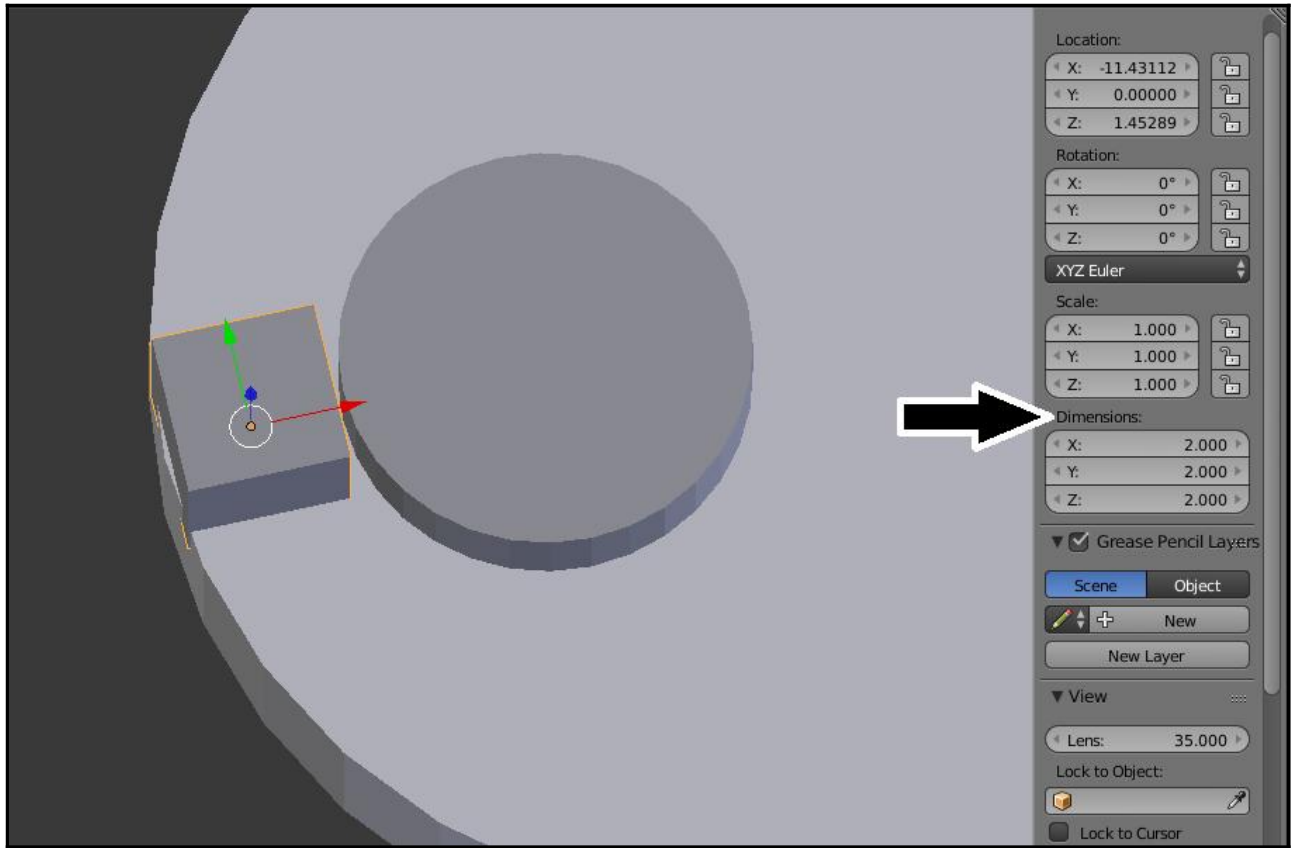

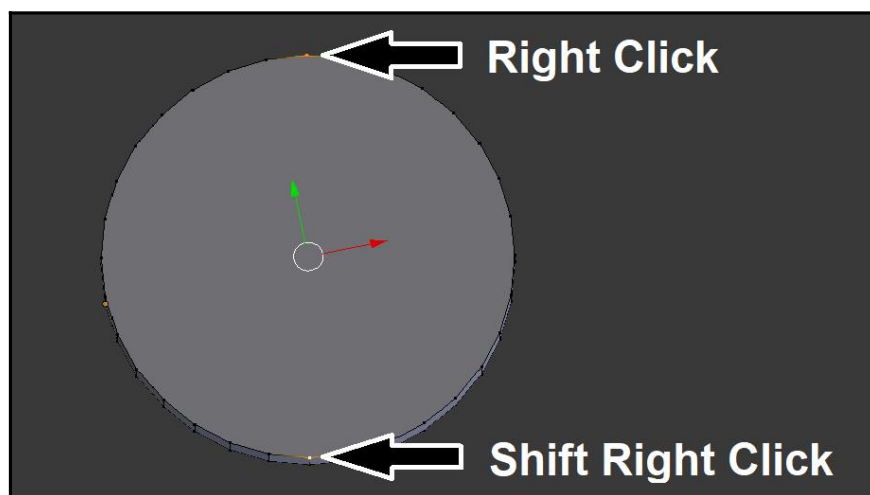
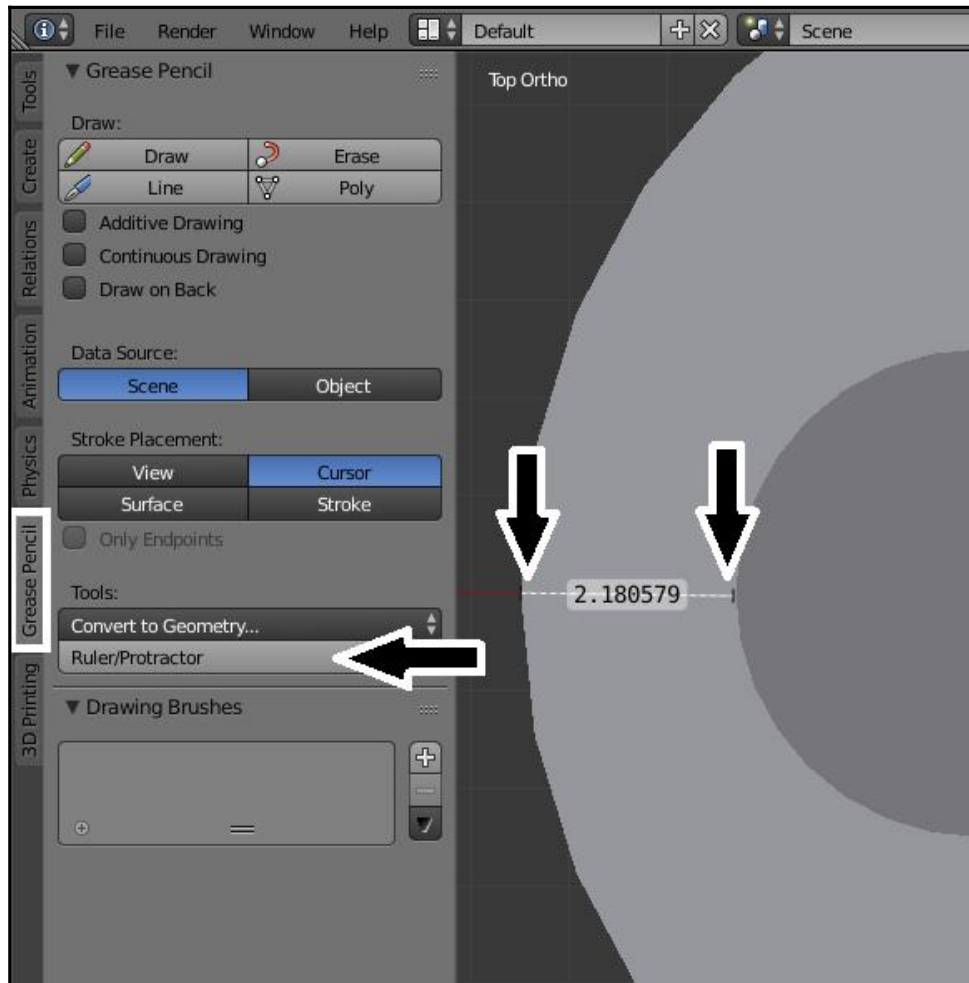

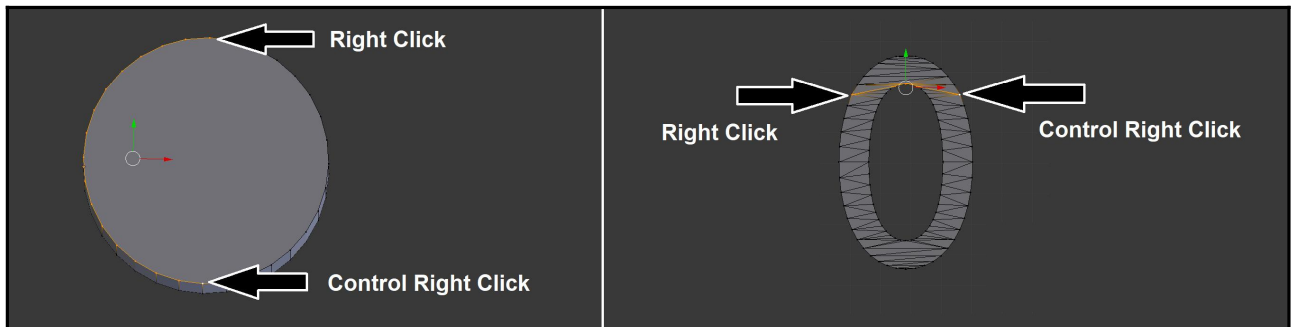
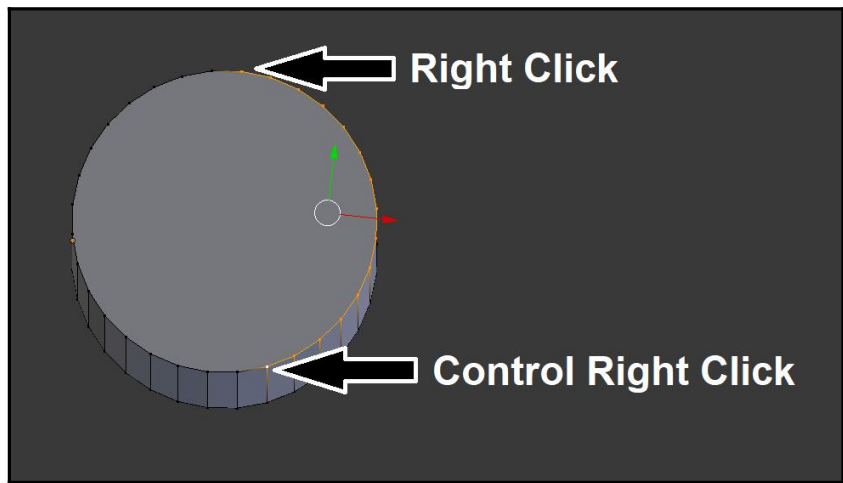
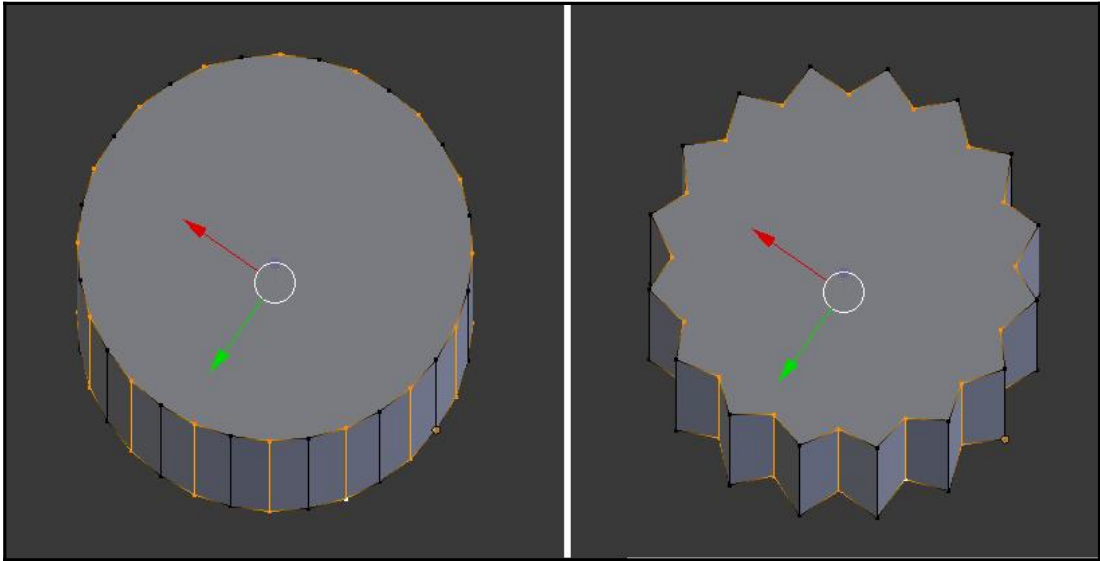

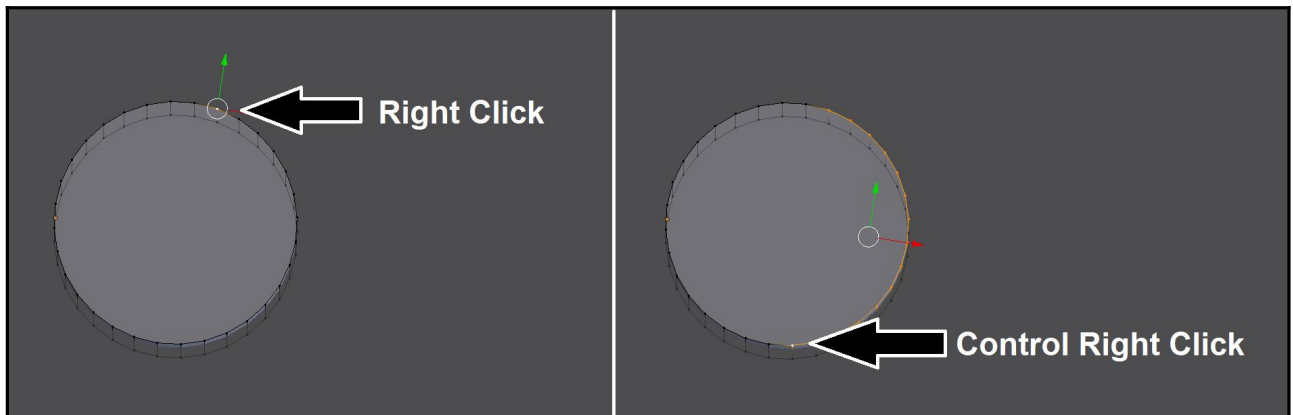
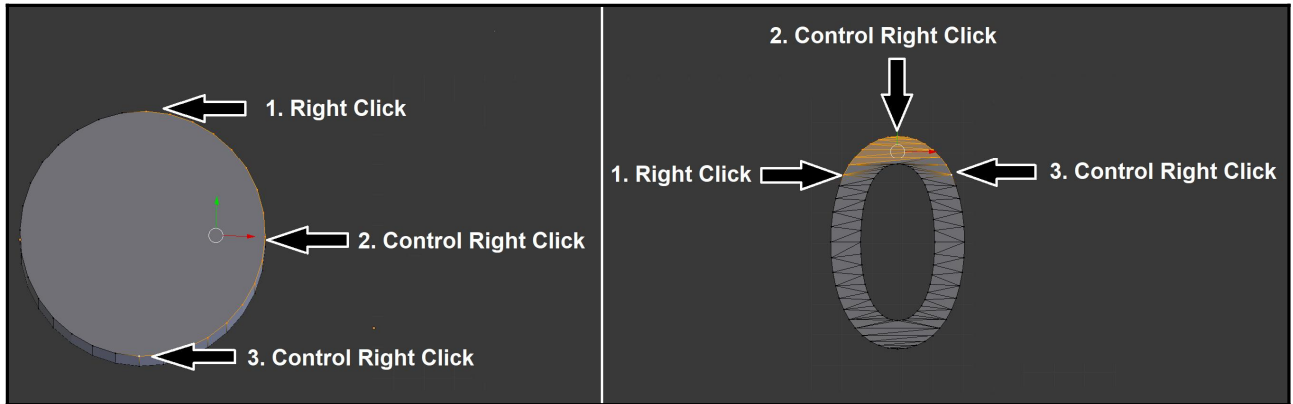

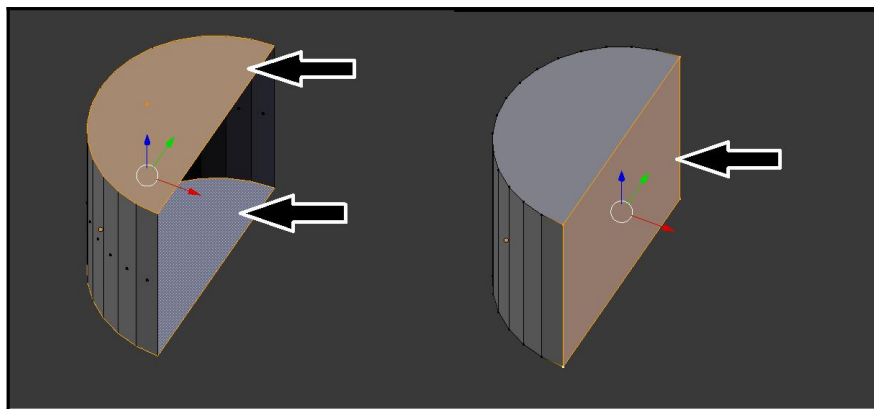
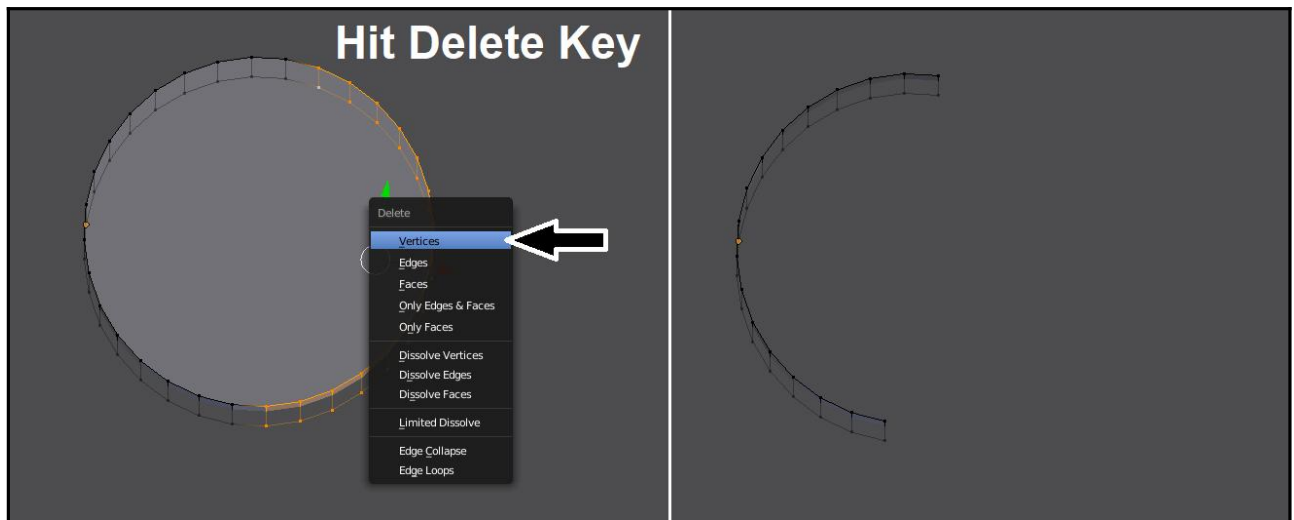
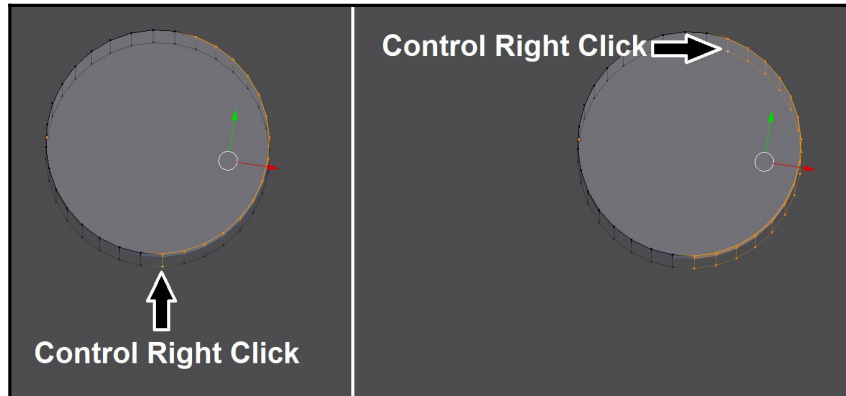

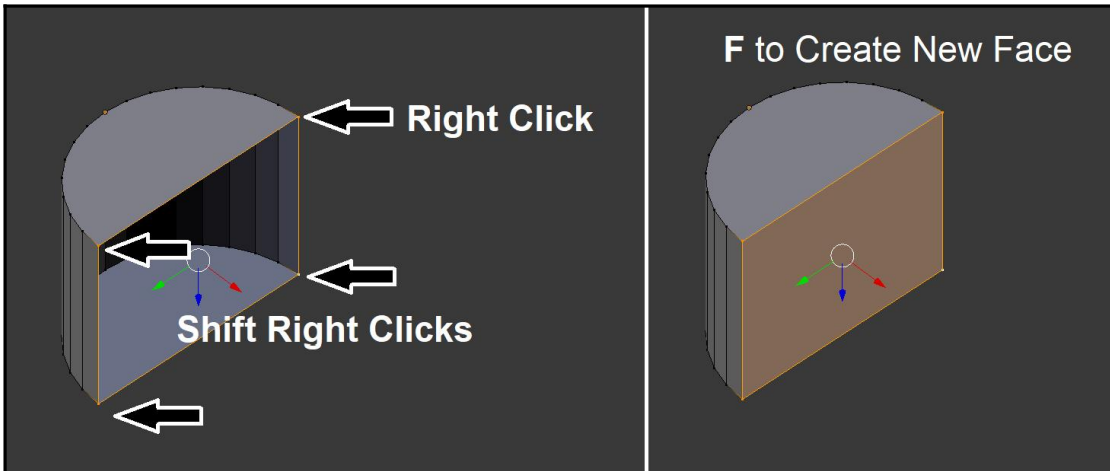
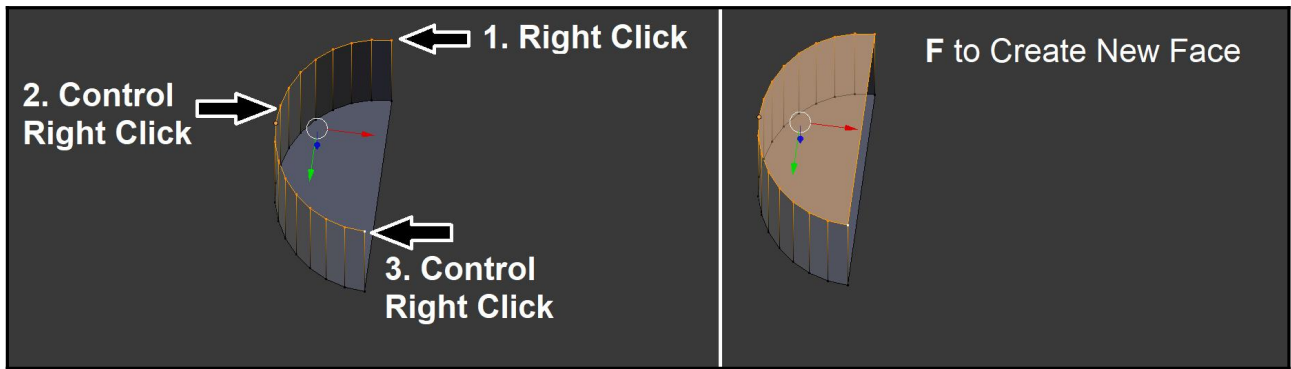
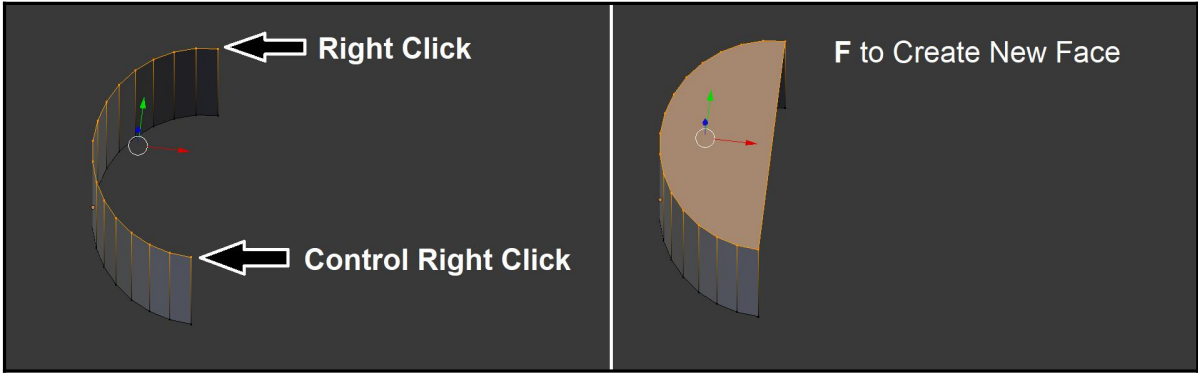

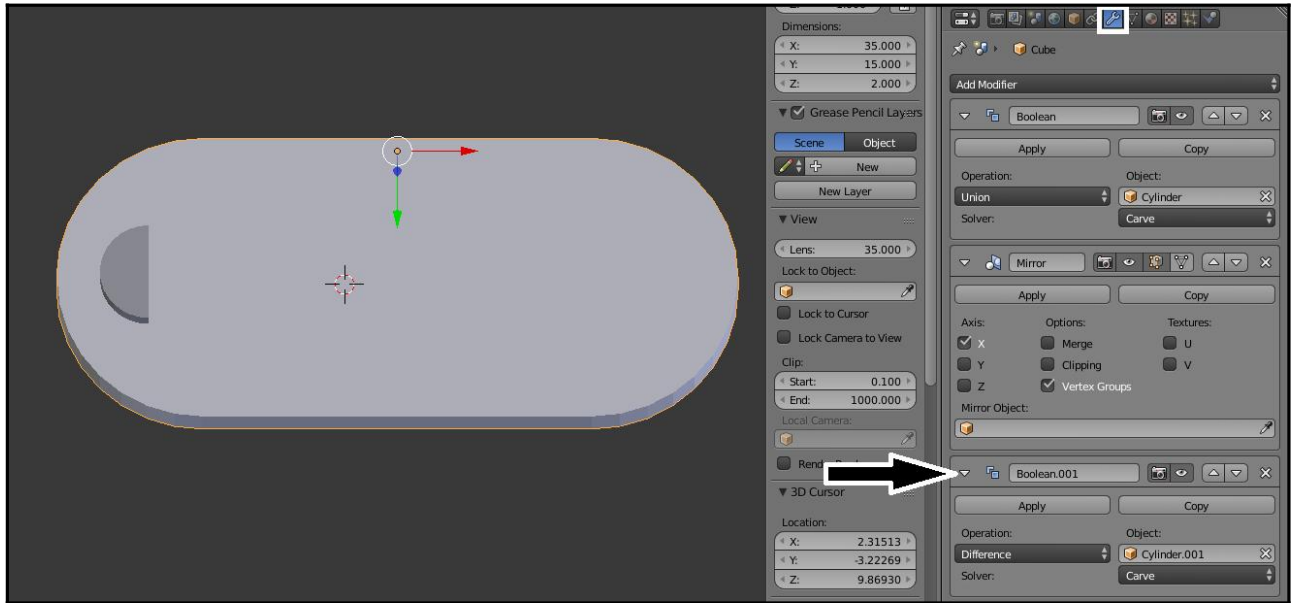
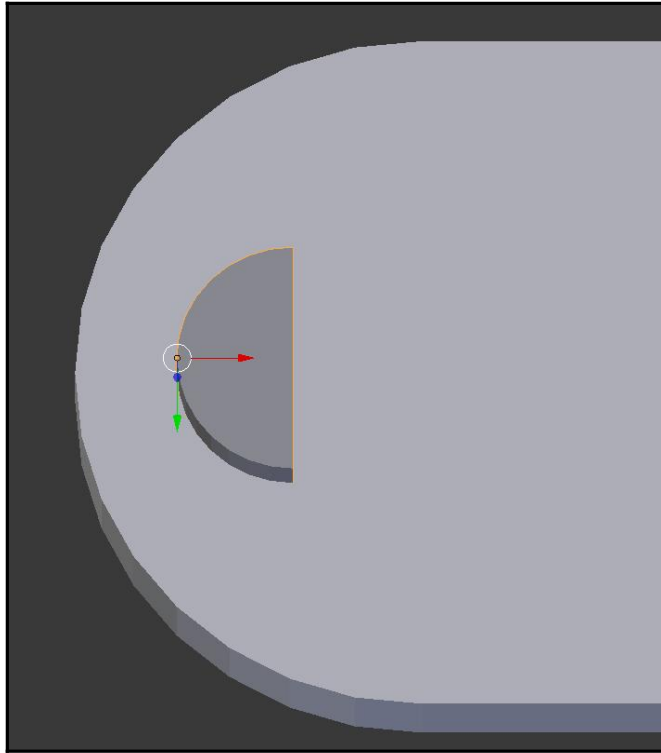



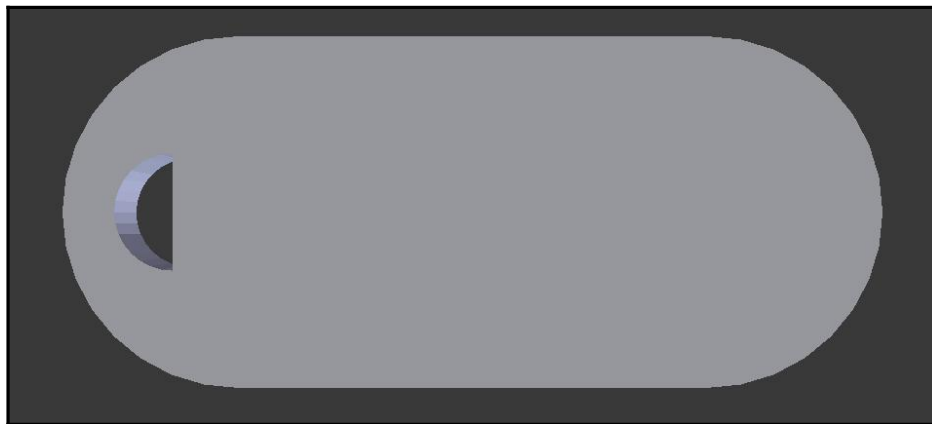
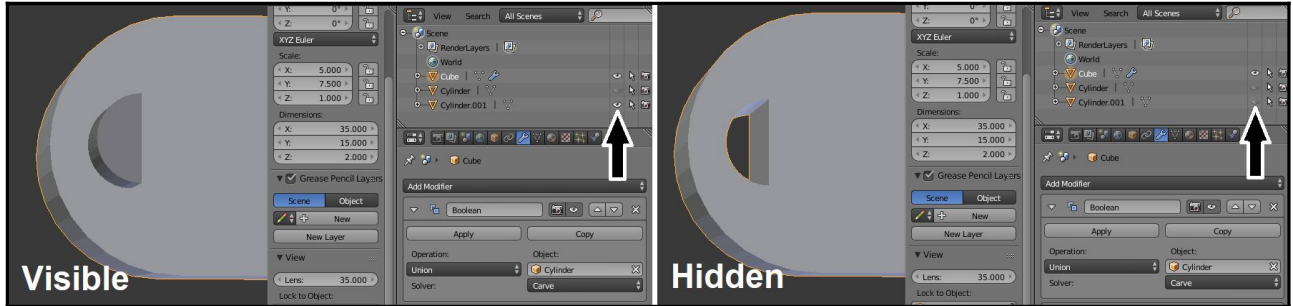

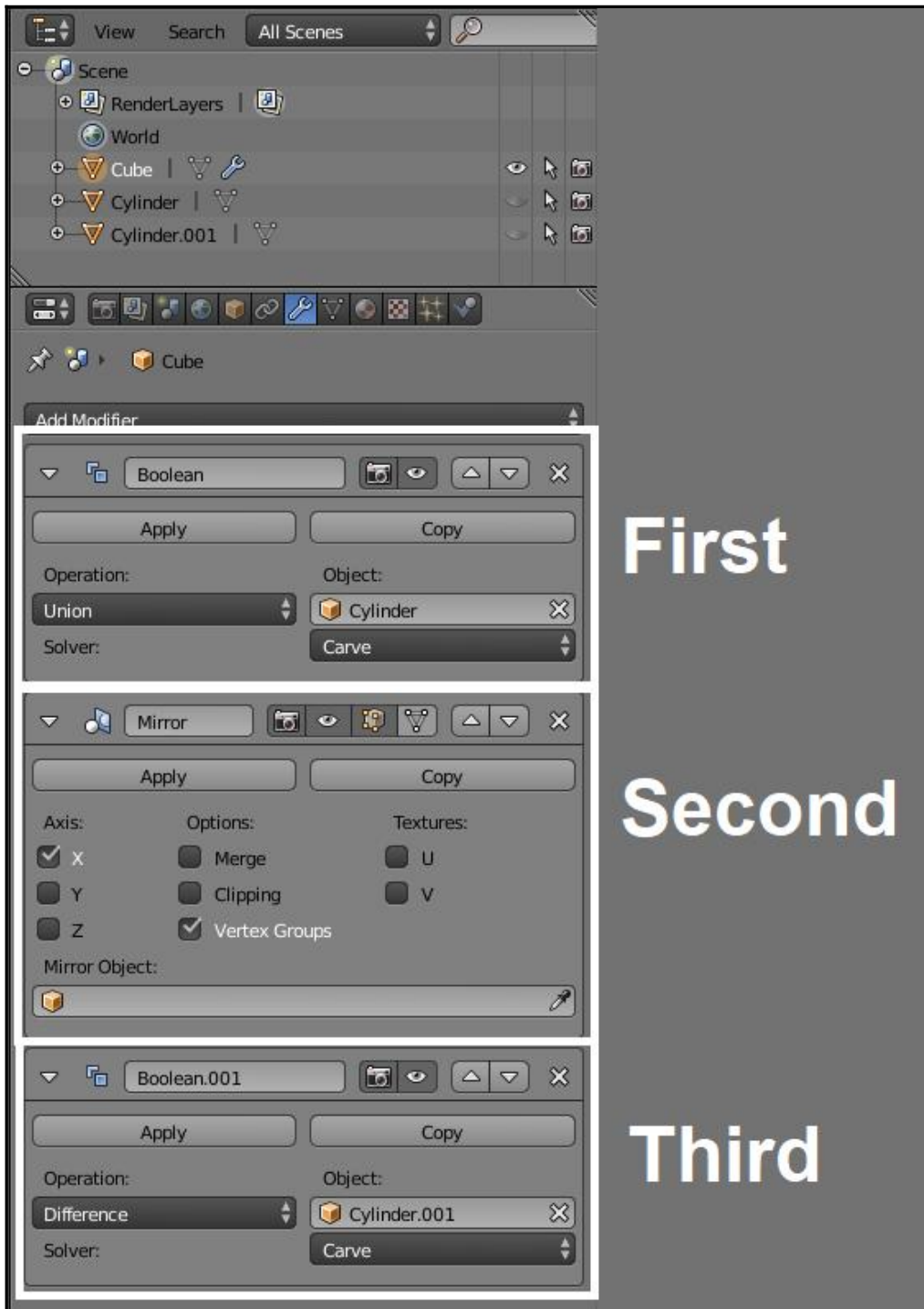

First

Second

Third

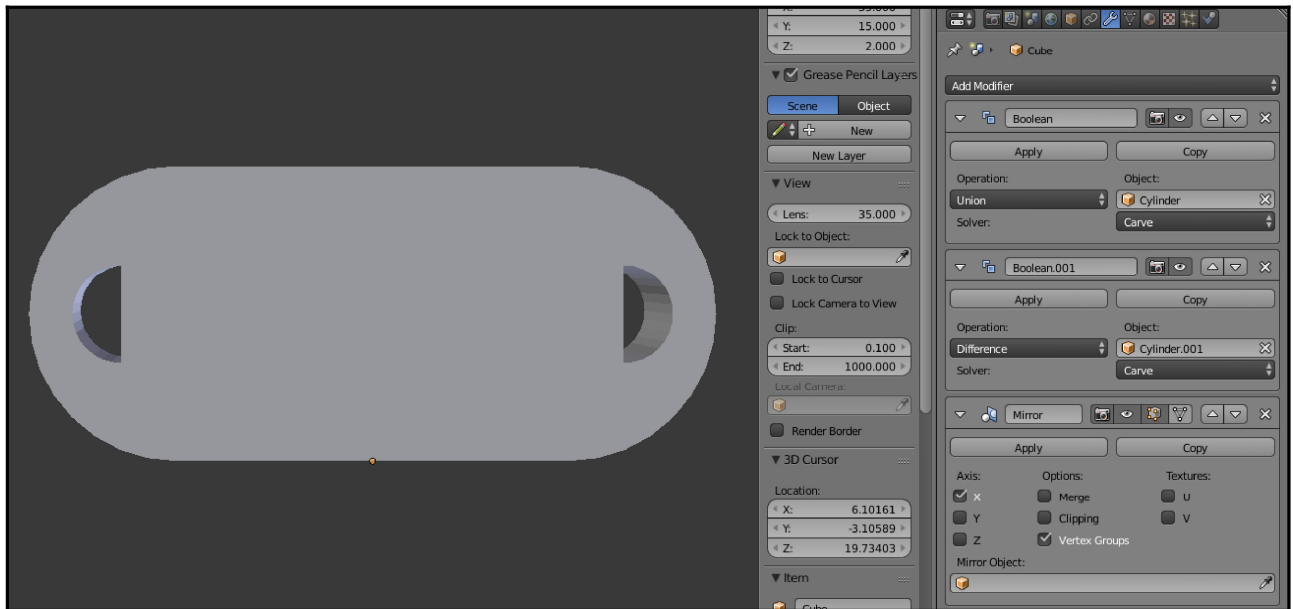
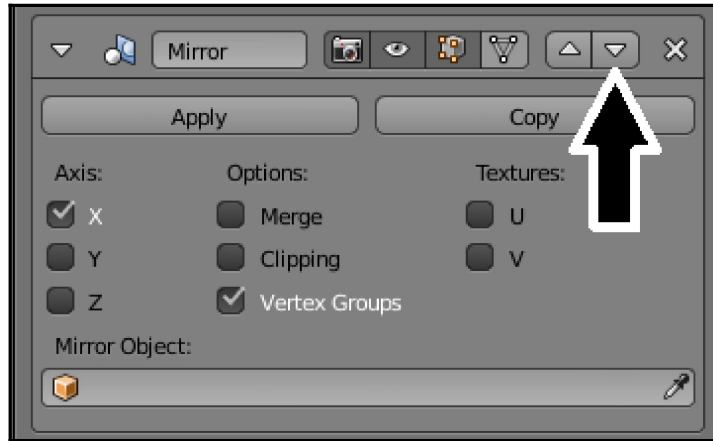

# Chapter 7: Customizing with Text

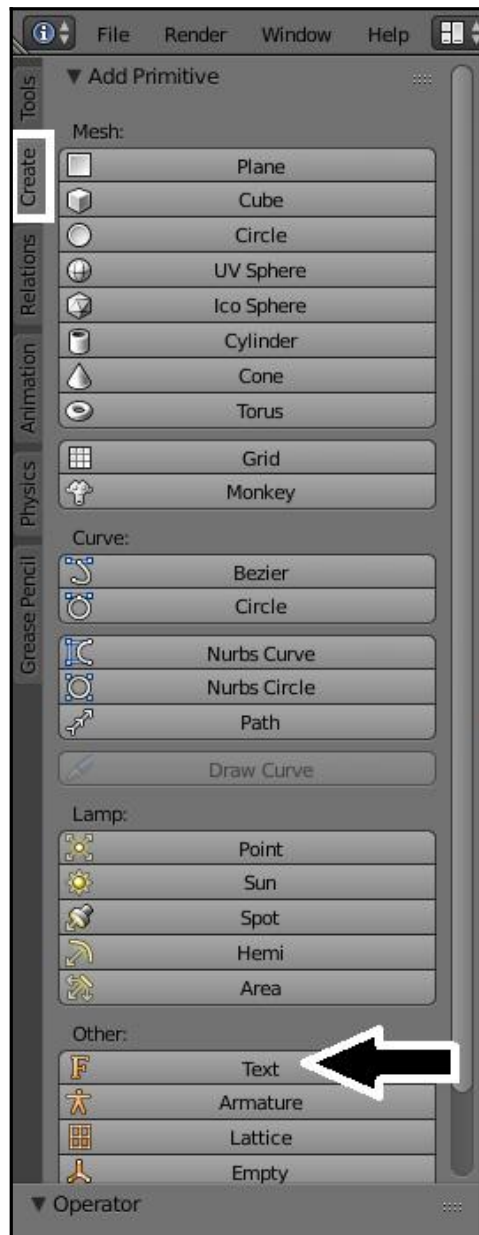

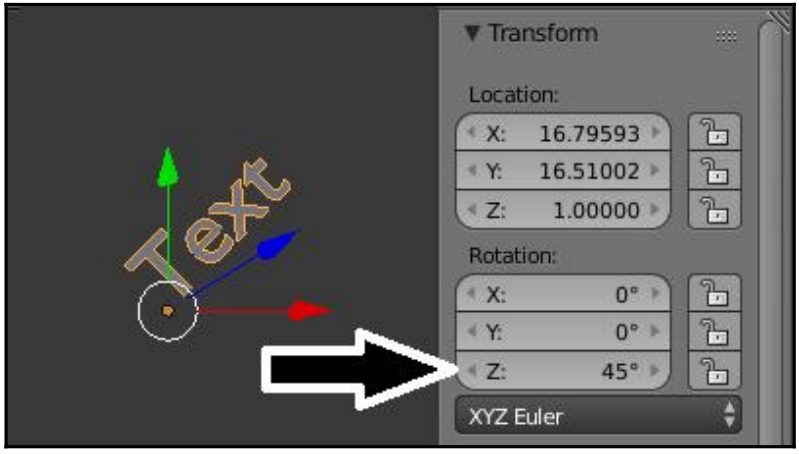
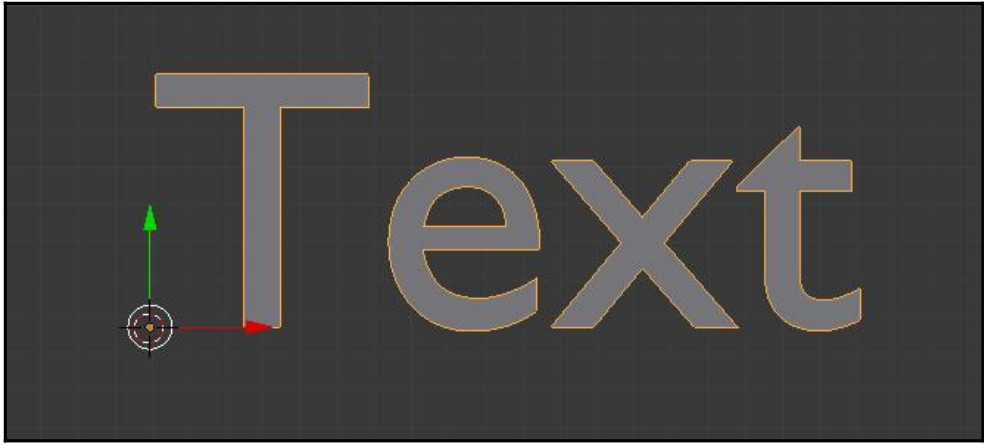

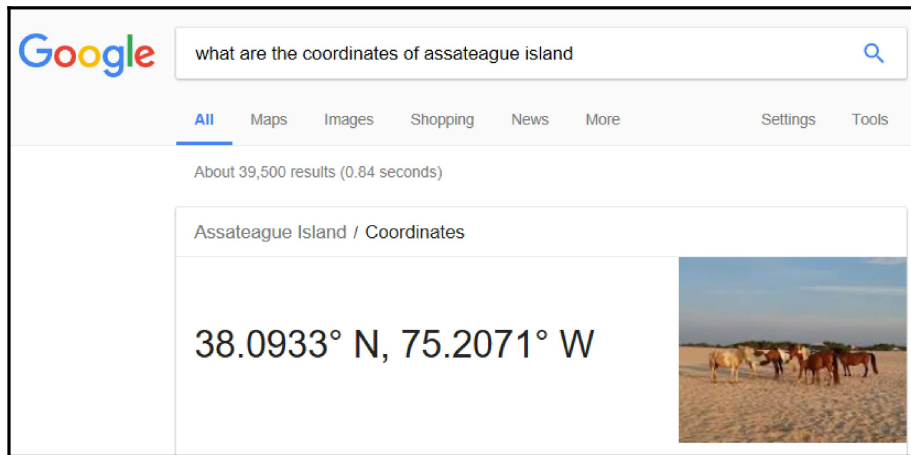
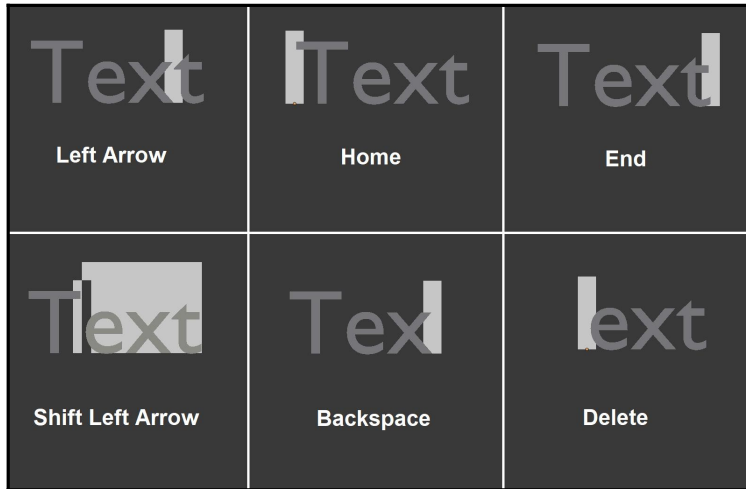

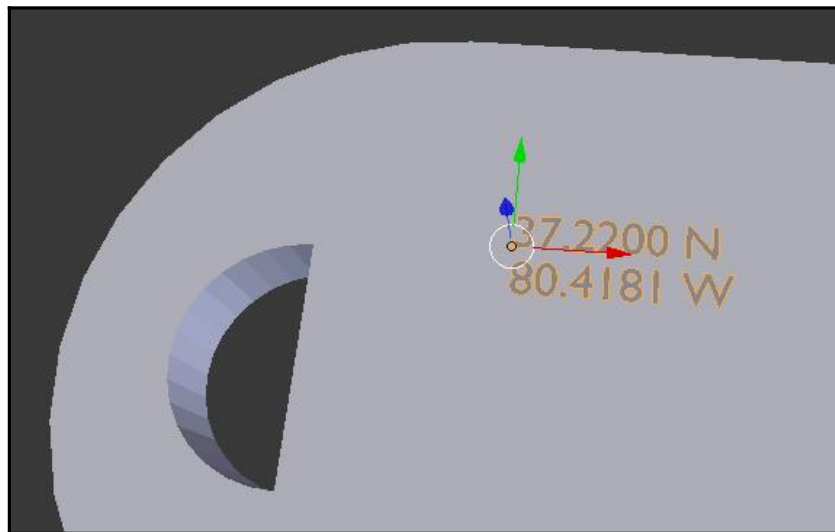
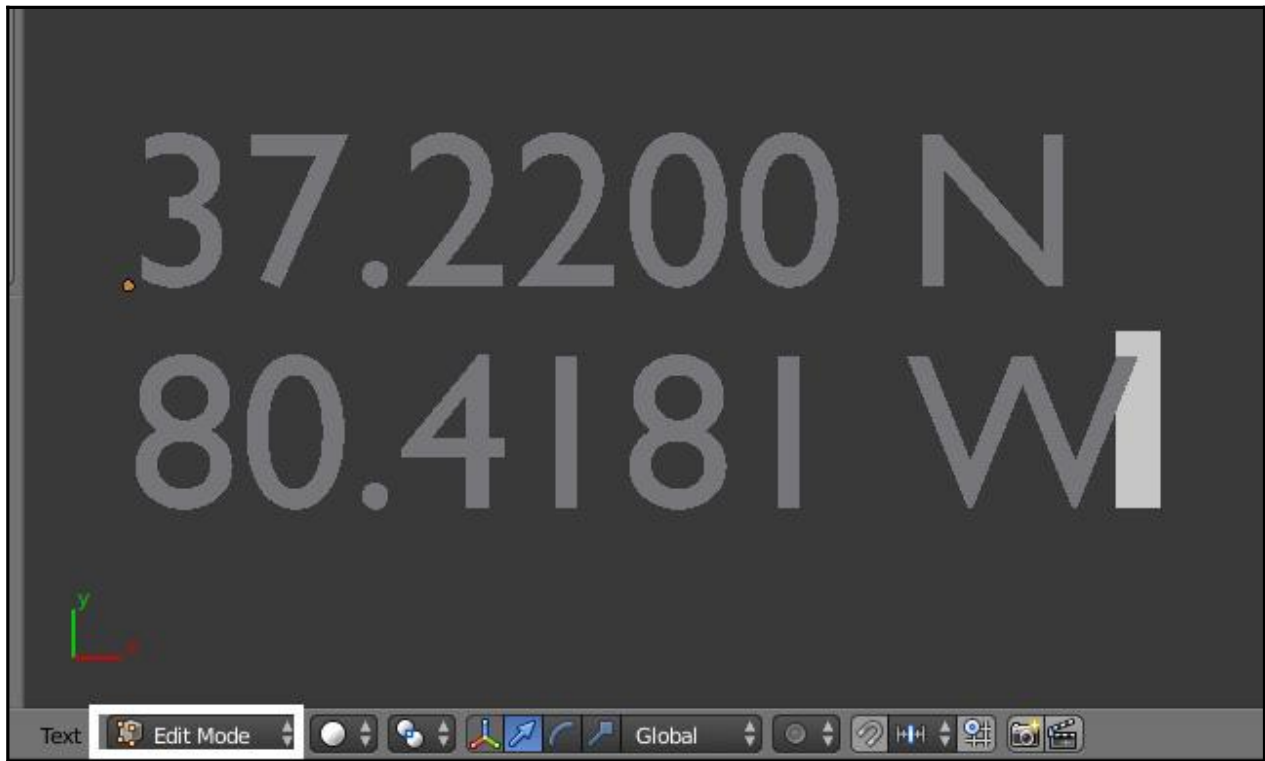

ABCDEFGHIJKLMNOPQRSTUVWXYZ

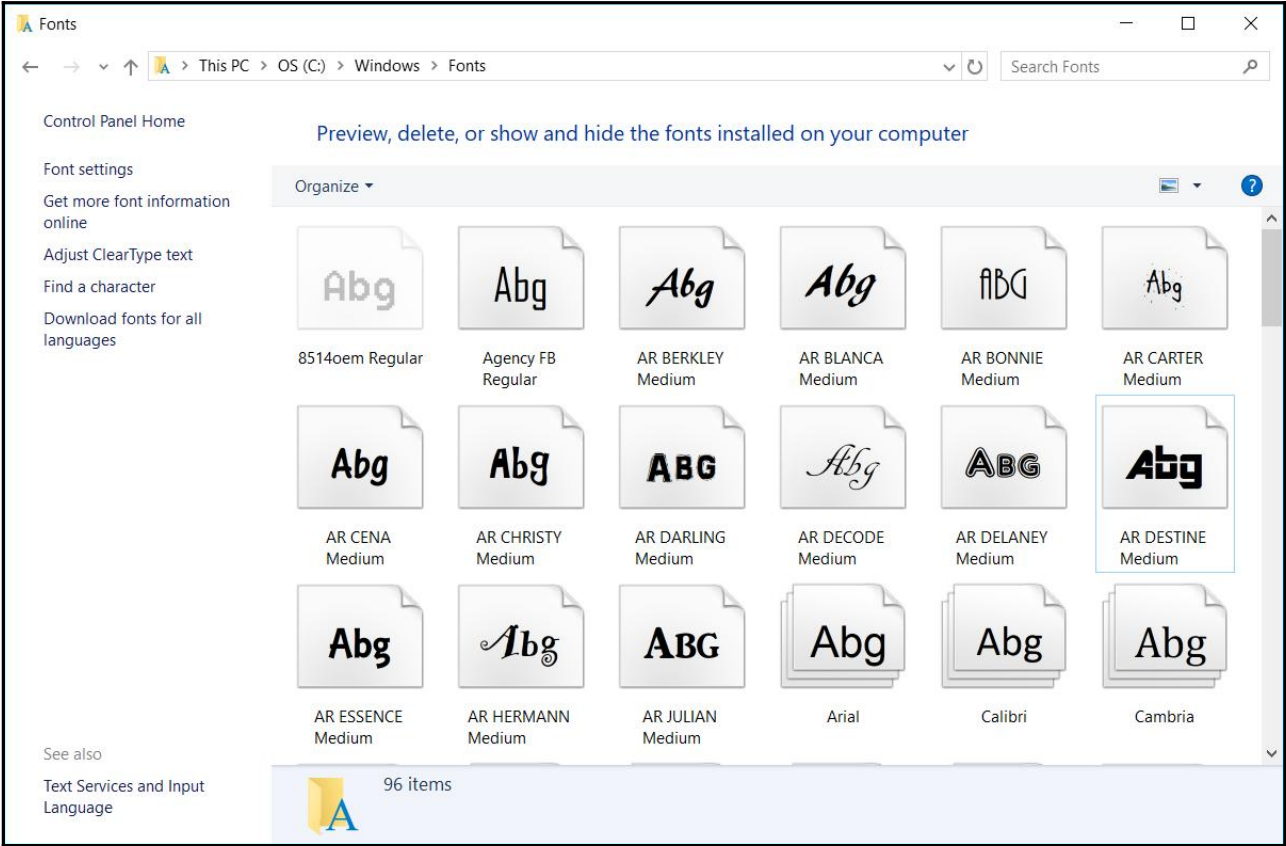
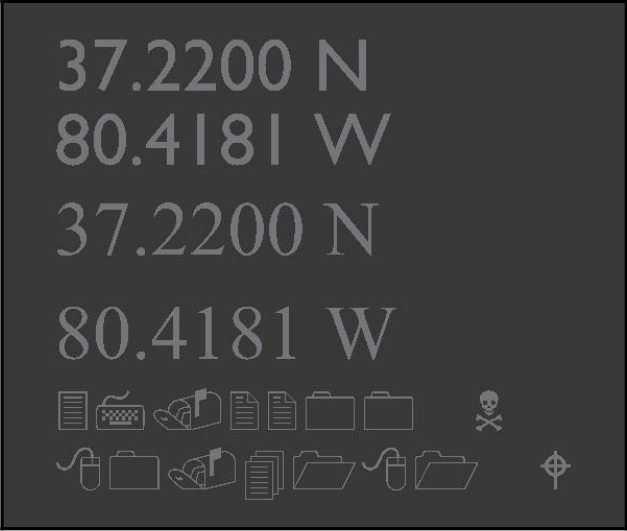



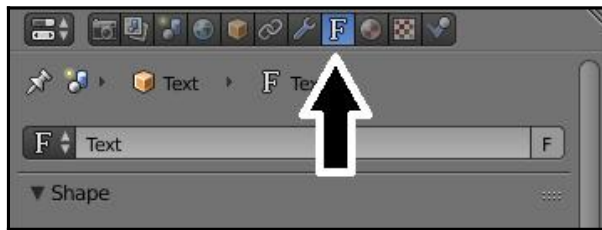
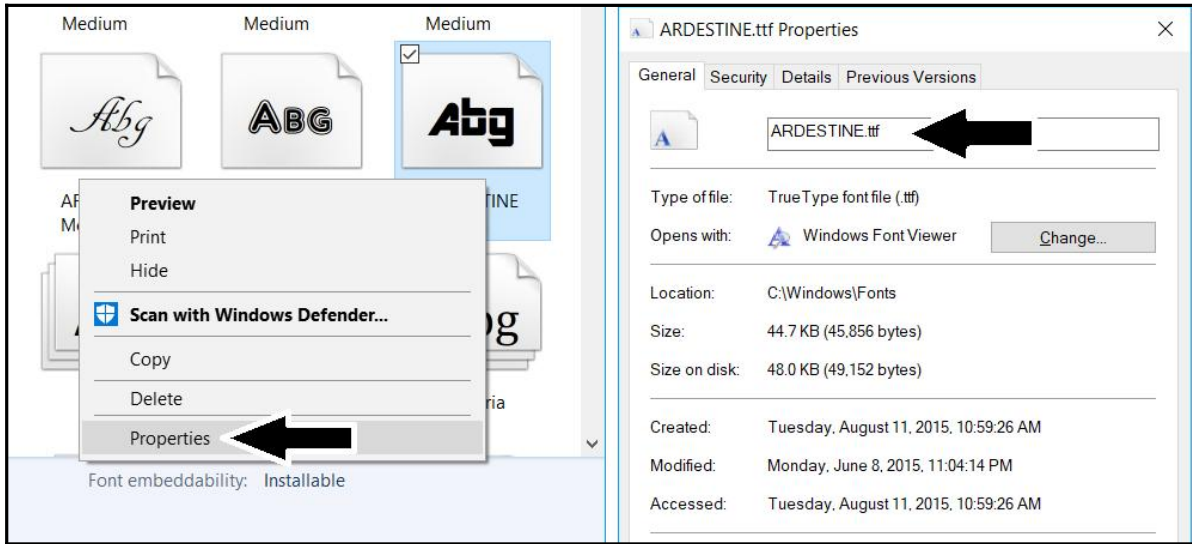

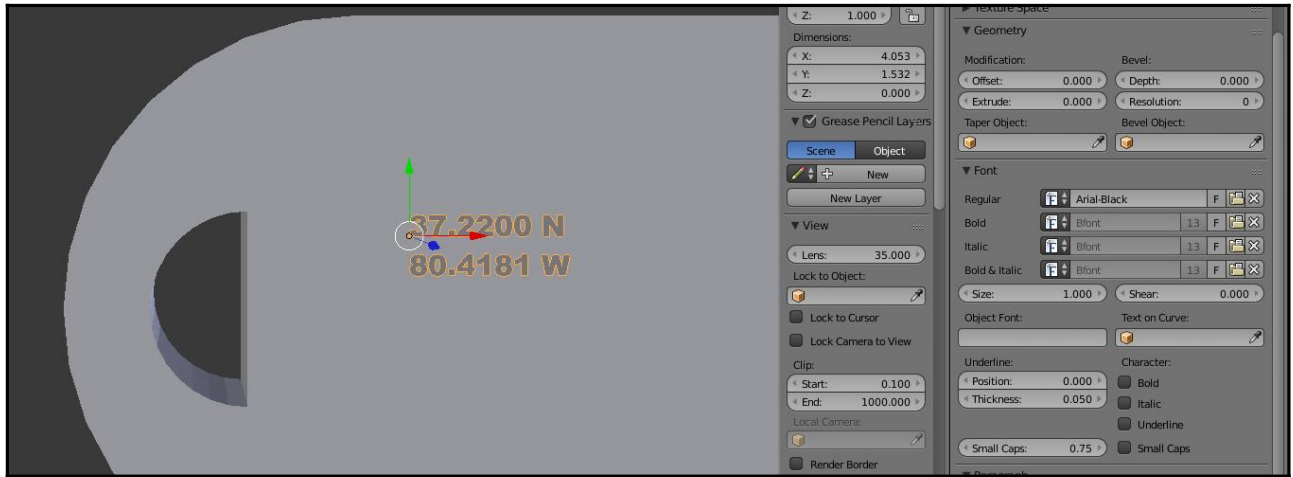
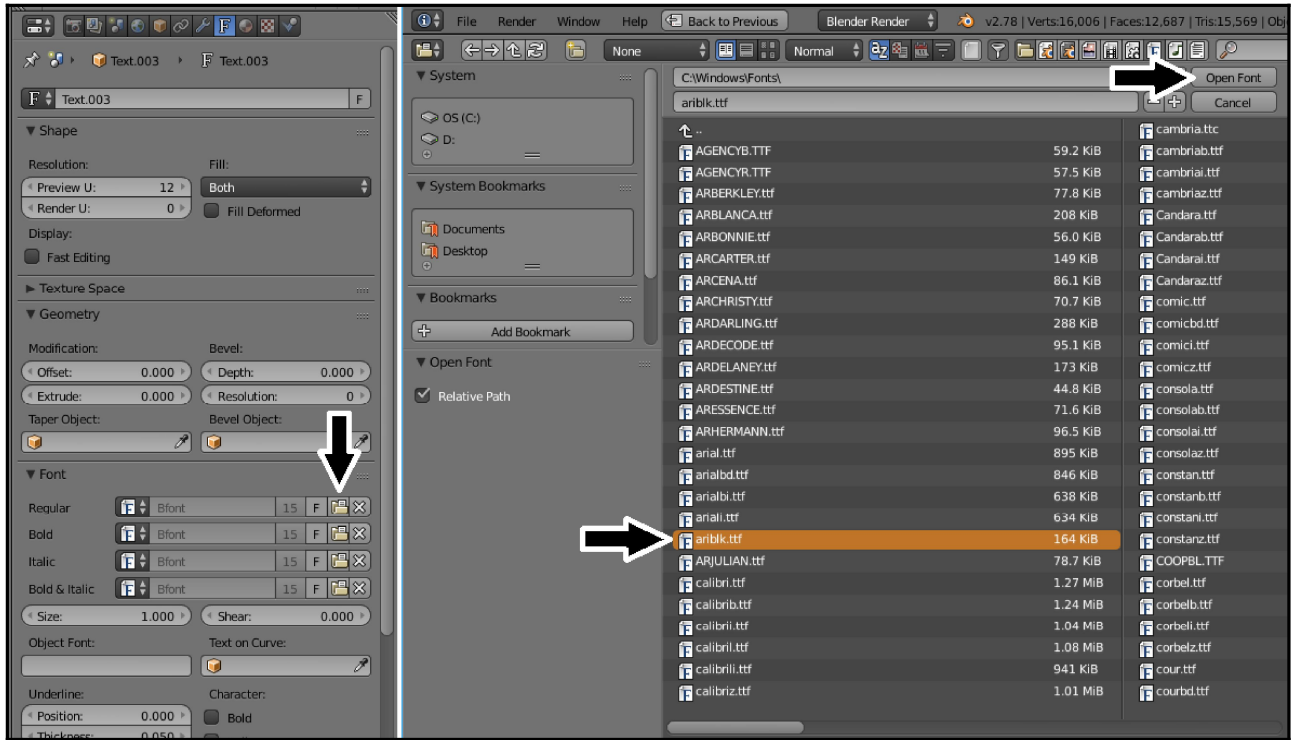

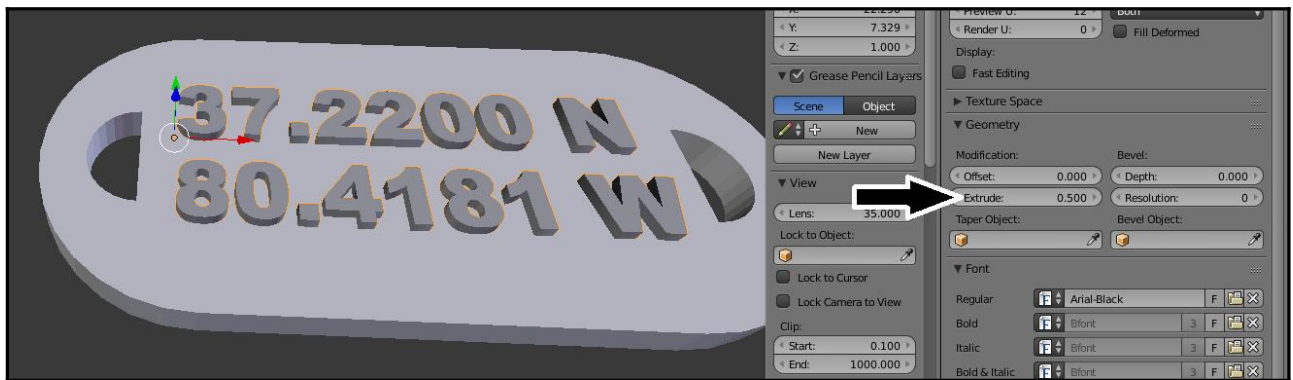
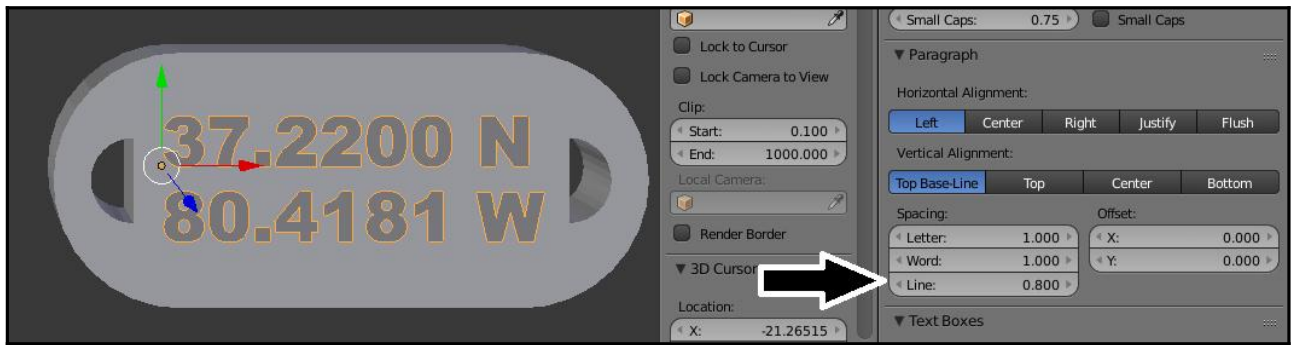
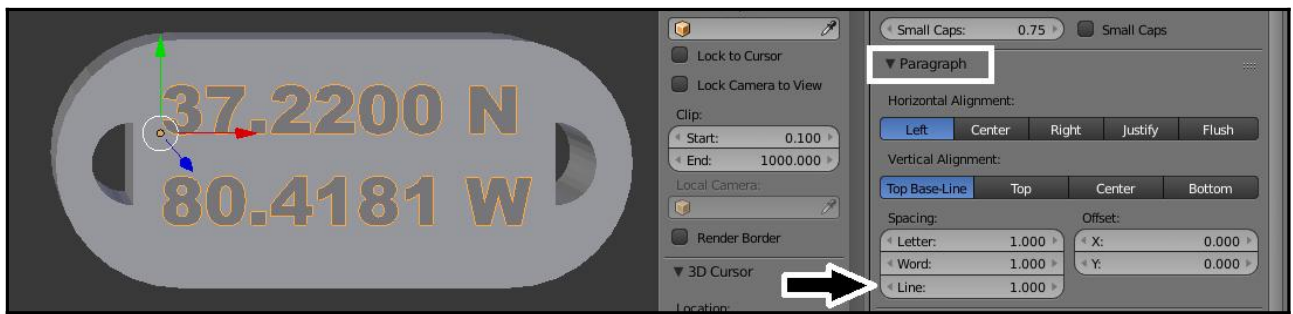
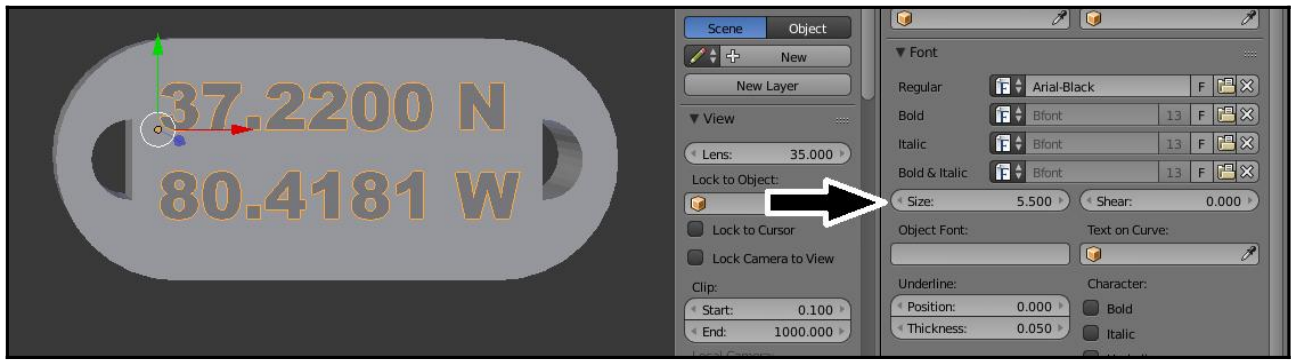

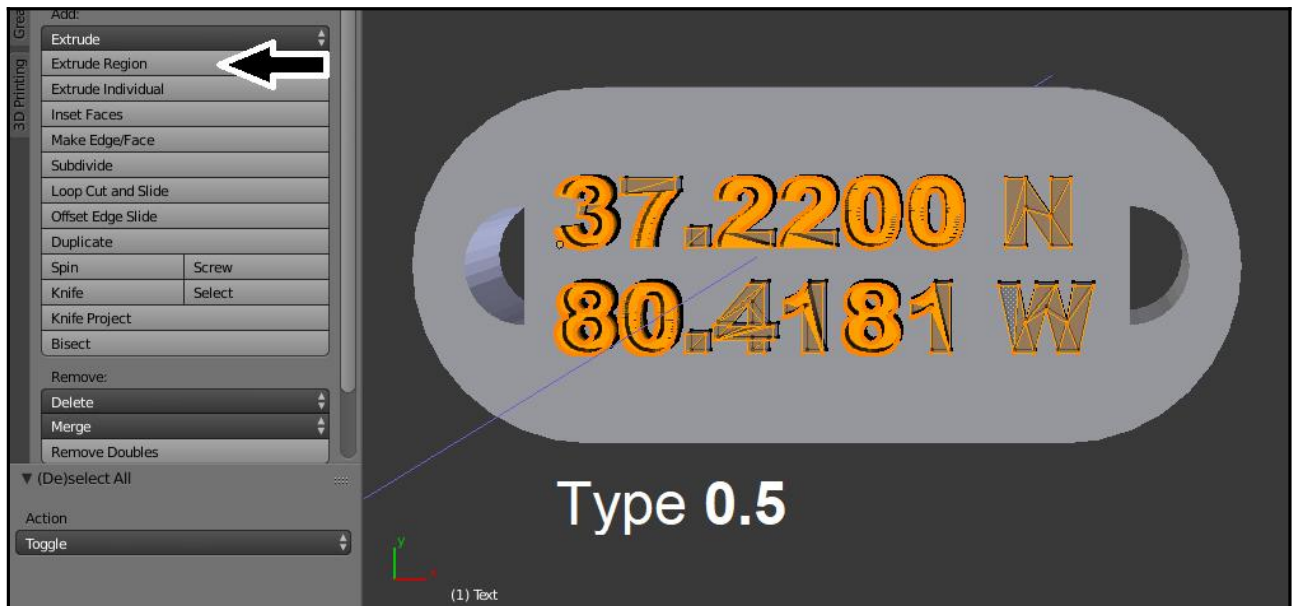
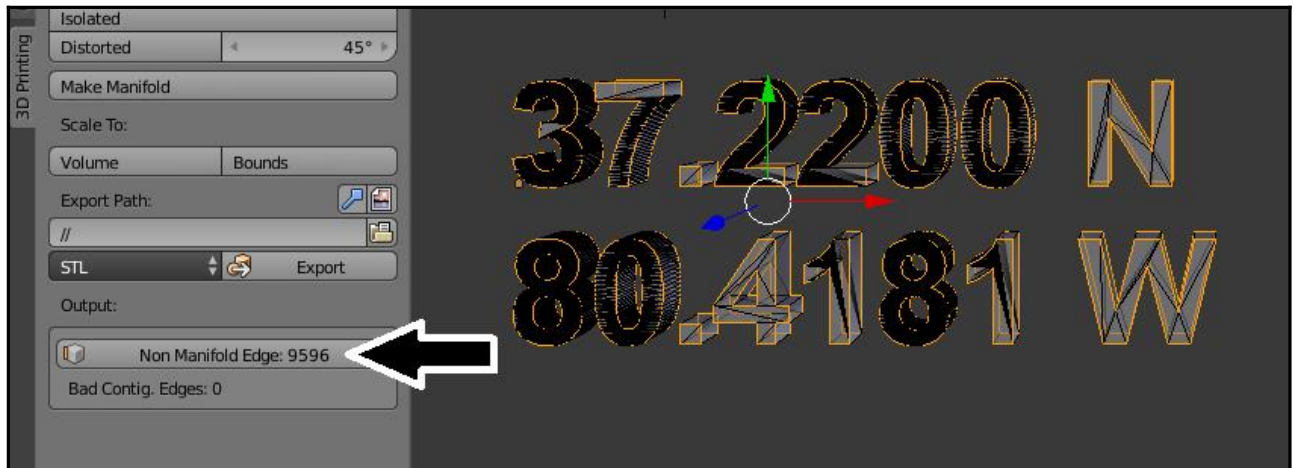

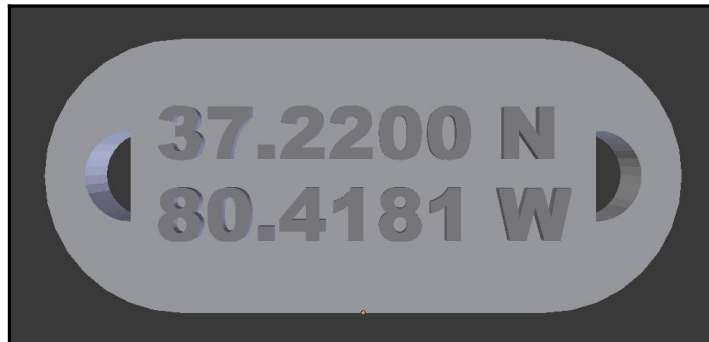
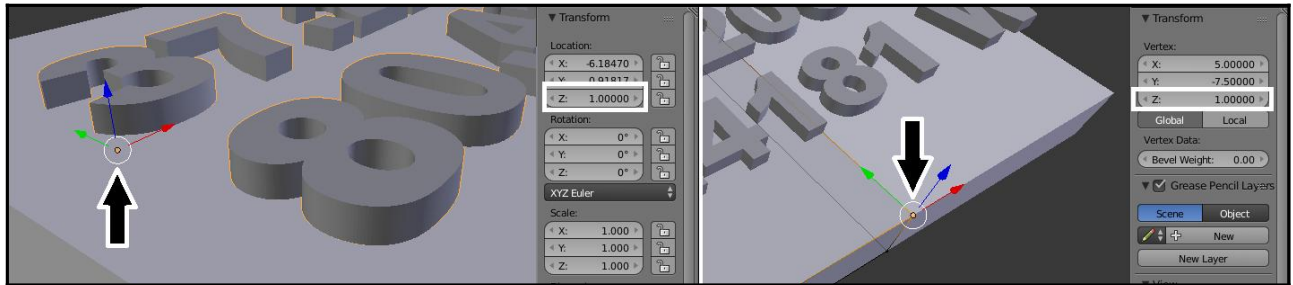

# Chapter 8: Using Empties to Model the Base of the House

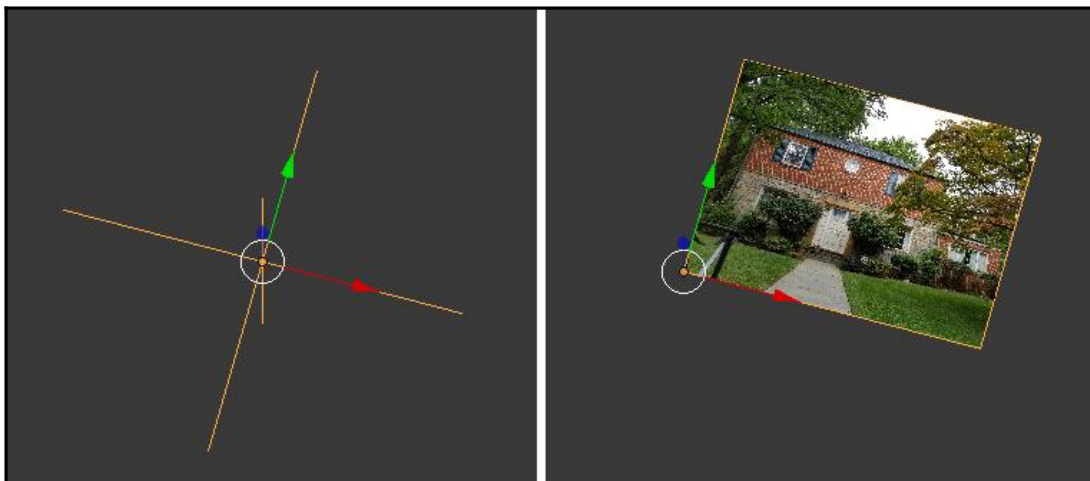
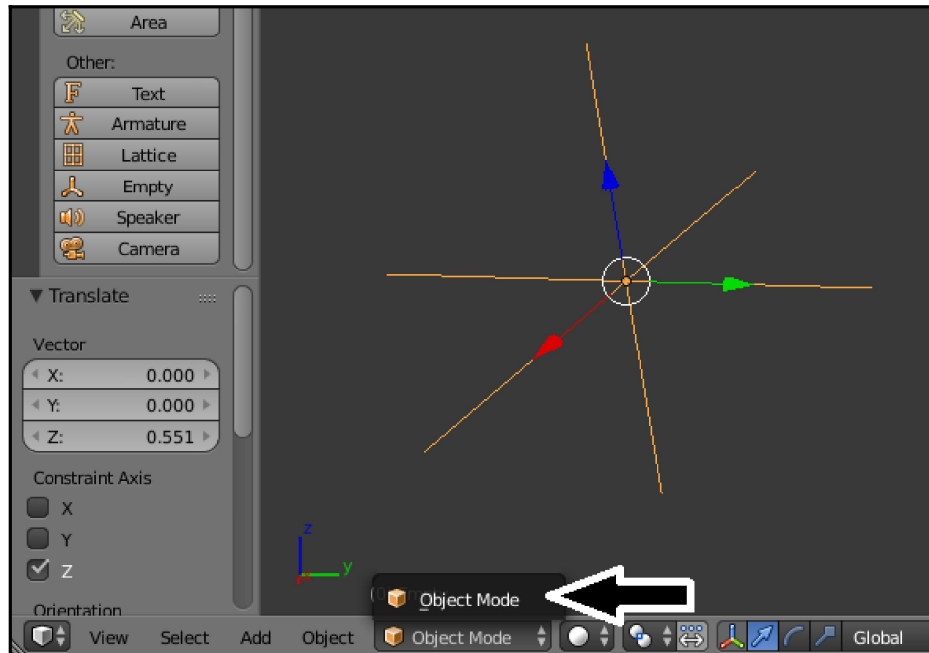

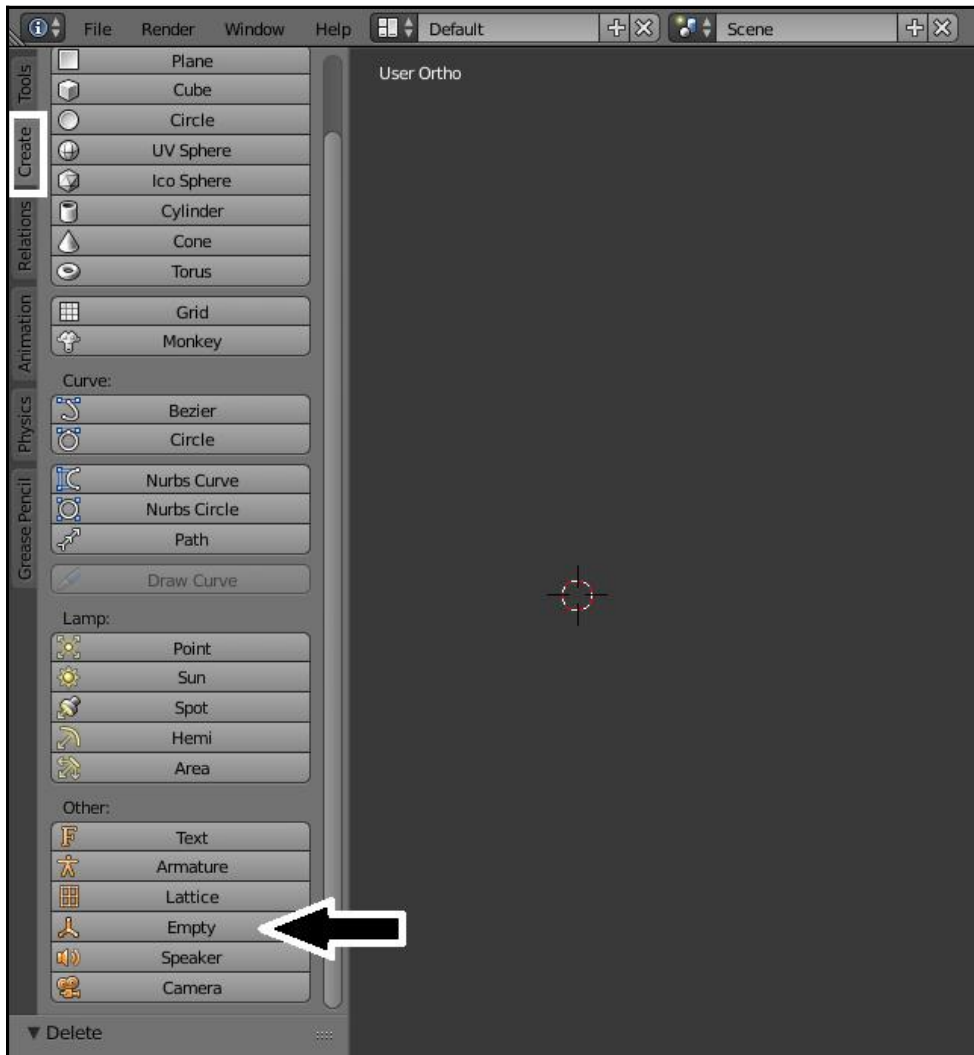

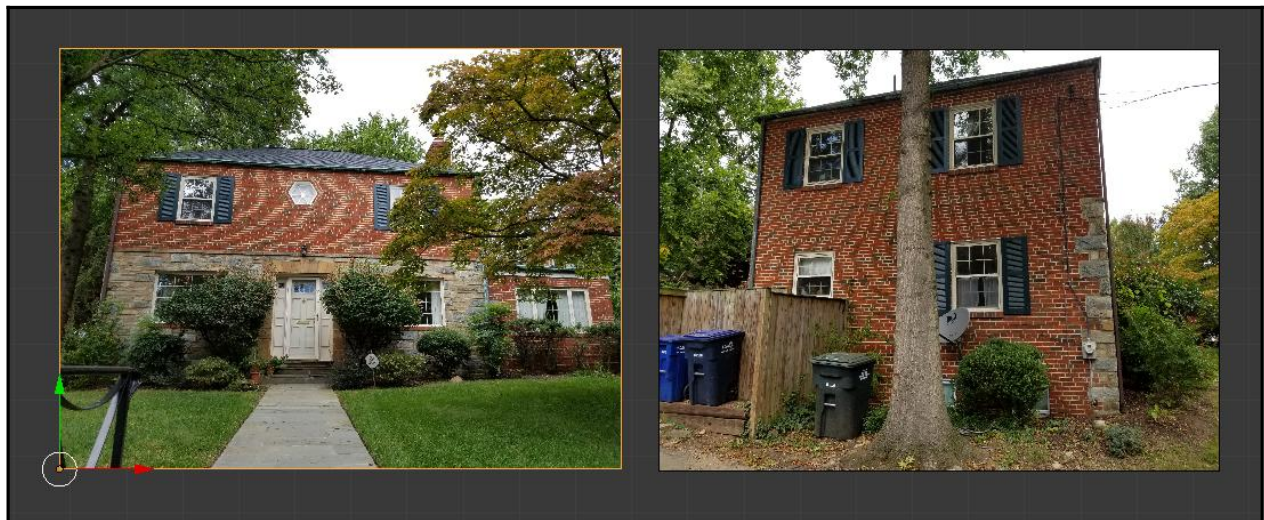
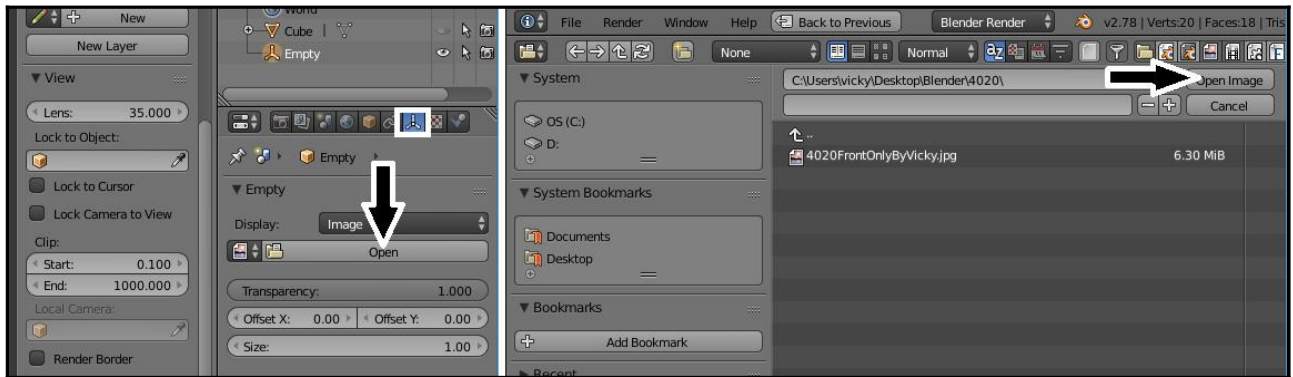
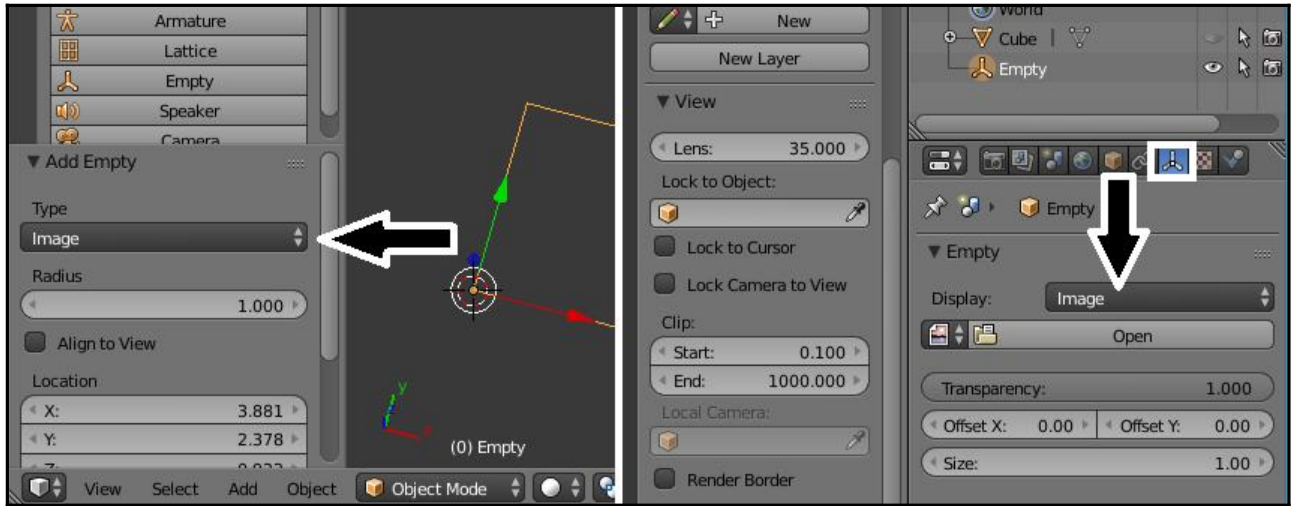



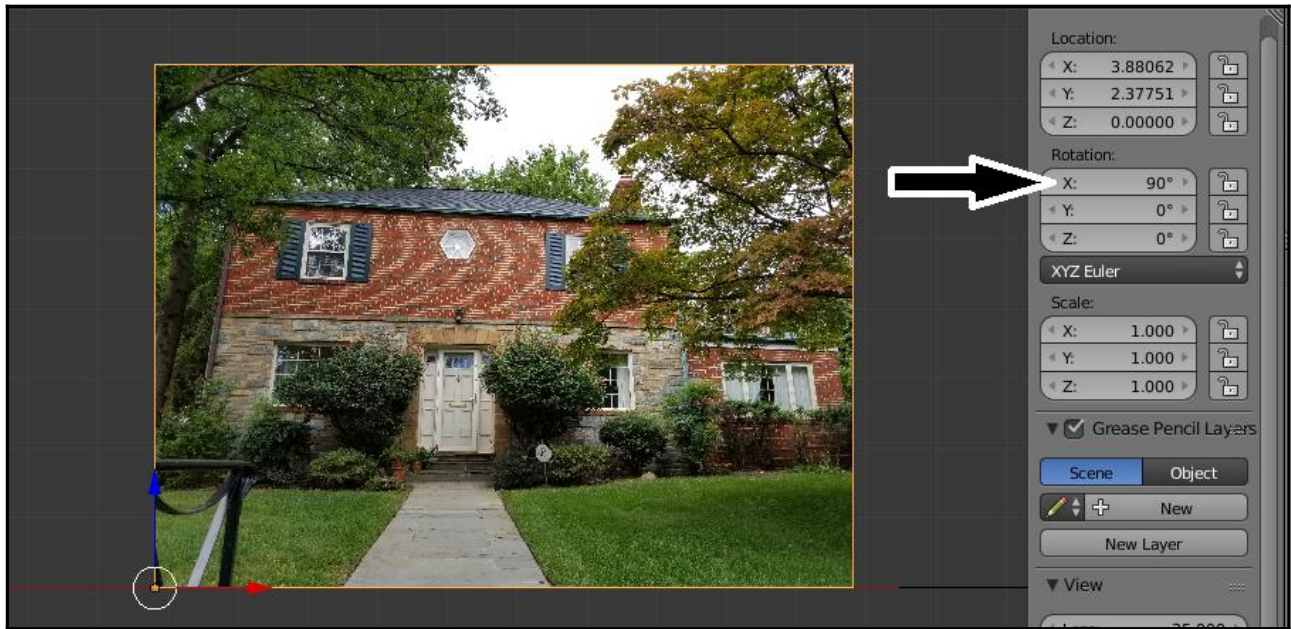





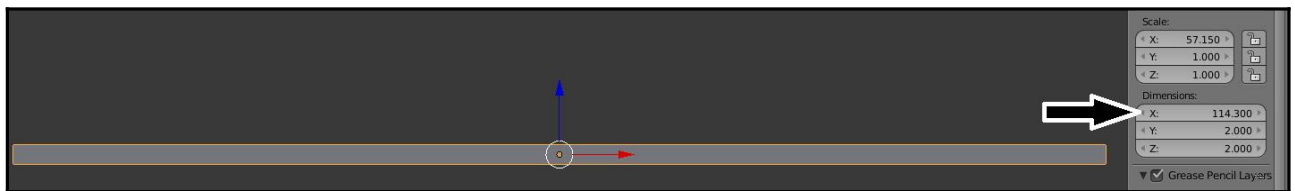
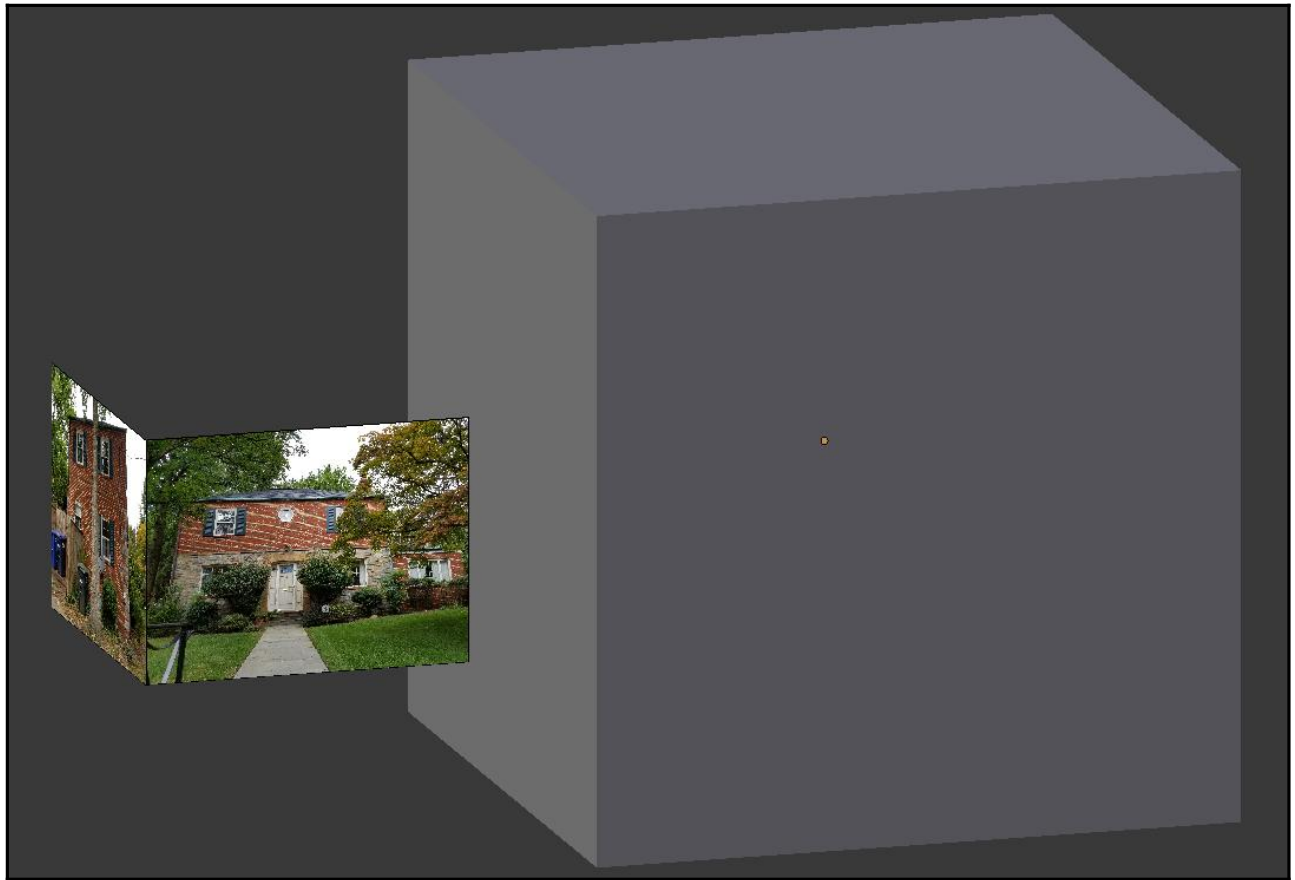

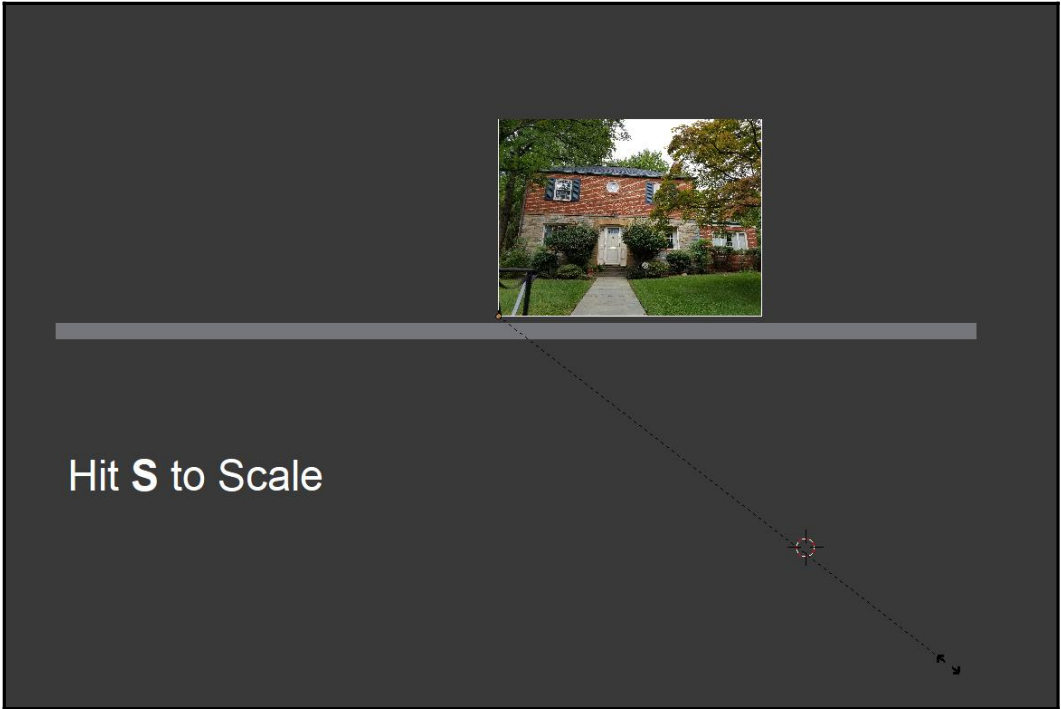

**Transform**

Location:

- X: 3.97181
- Y: 2.37751
- Z: 0.00000

Rotation:

- X: 90°
- Y: 0°
- Z: 0°

XYZ Euler

Scale:

- X: 123.048
- Y: 123.048
- Z: 123.048

Grease Pencil Layers

Scene Object

New

New Layer

**View**

Lens: 35.000

Lock to Object:

- Lock to Cursor
- Lock Camera to View

This image shows a larger view of the same brick house. A grey horizontal bar is positioned below the house. A red circle with a crosshair is located on the grass in the foreground. To the right, a software interface panel is visible, displaying transform and view settings.

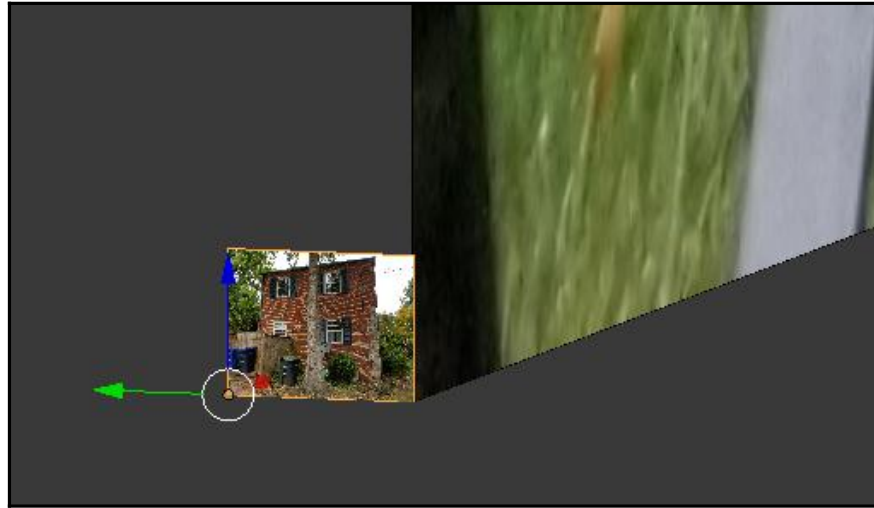

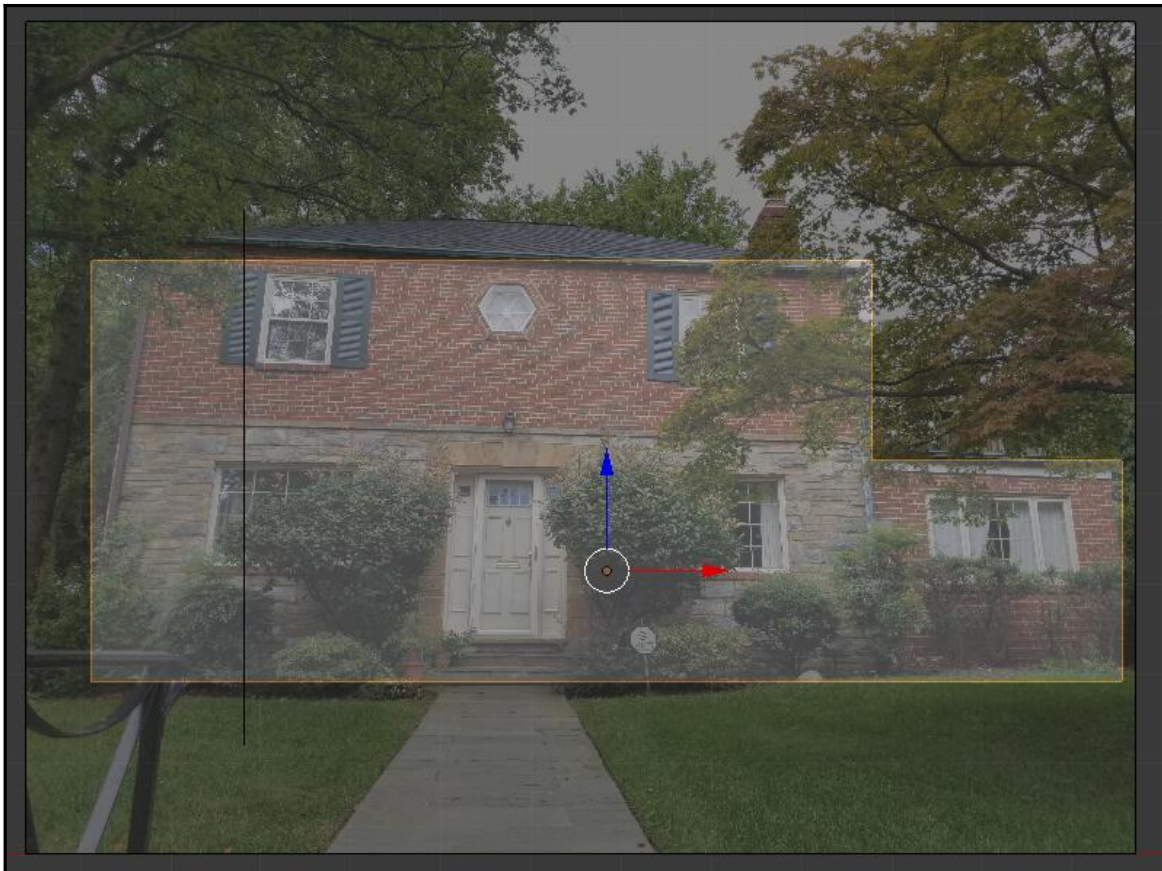

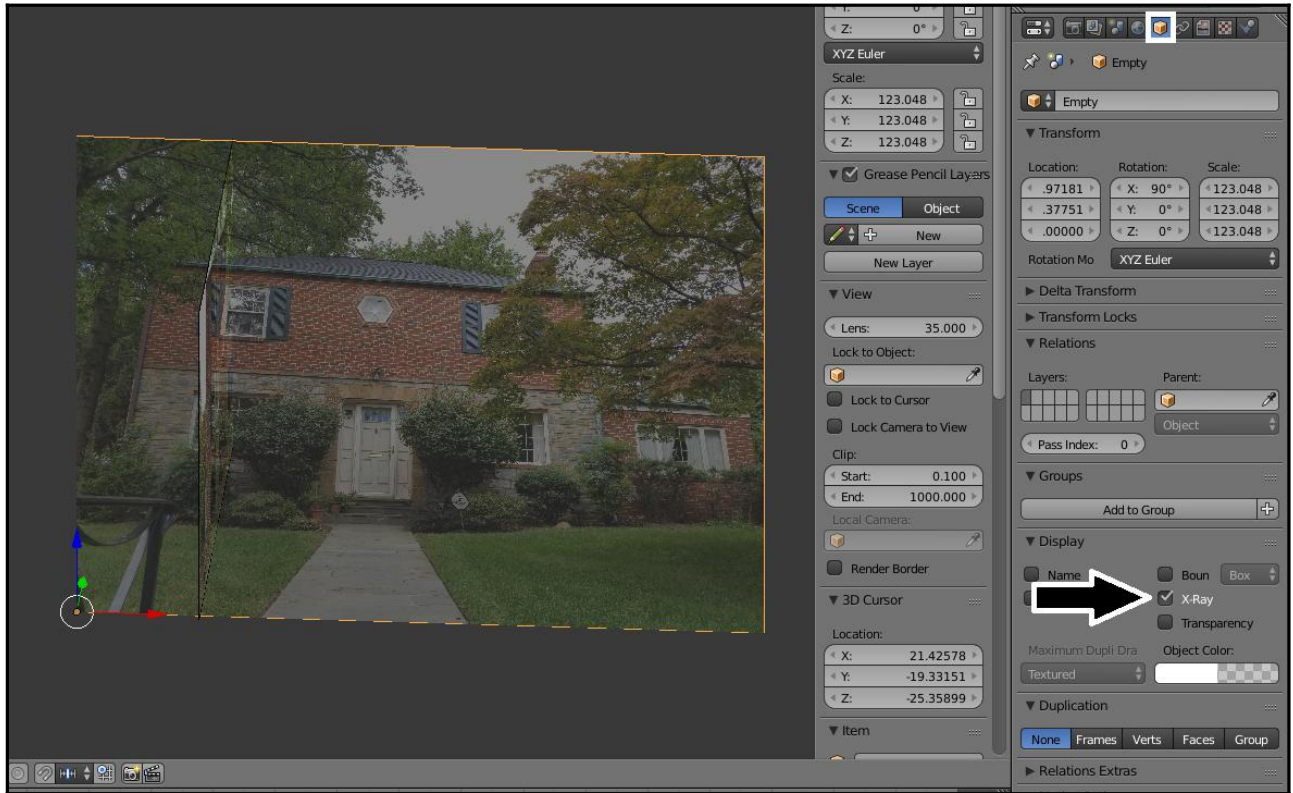
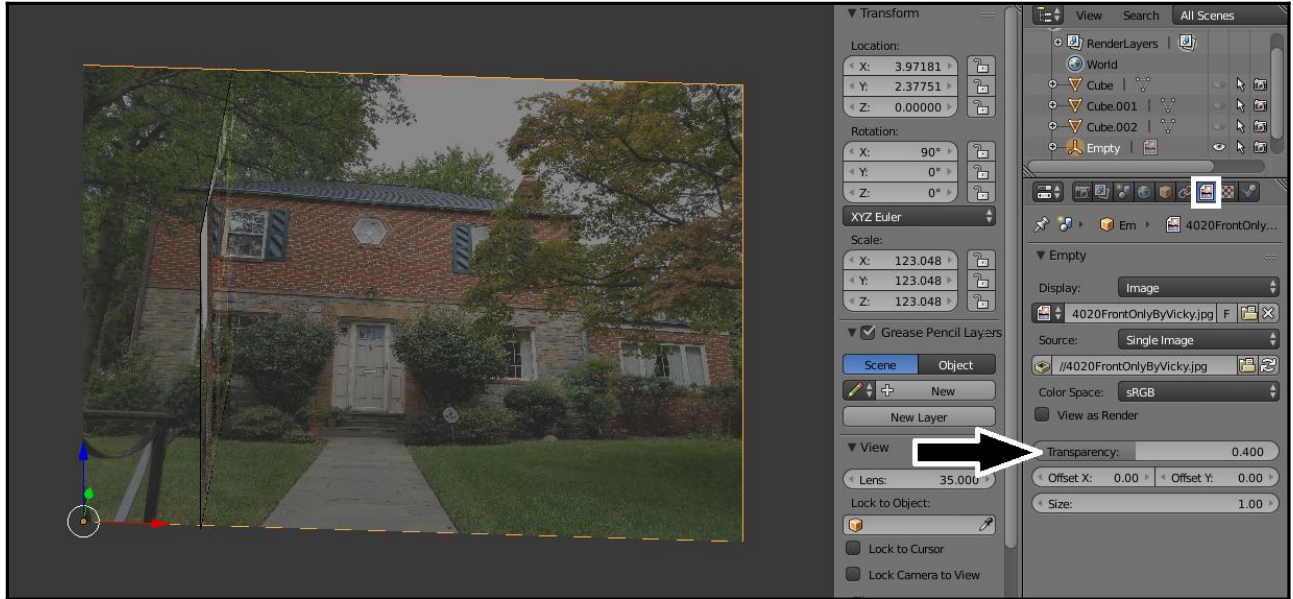



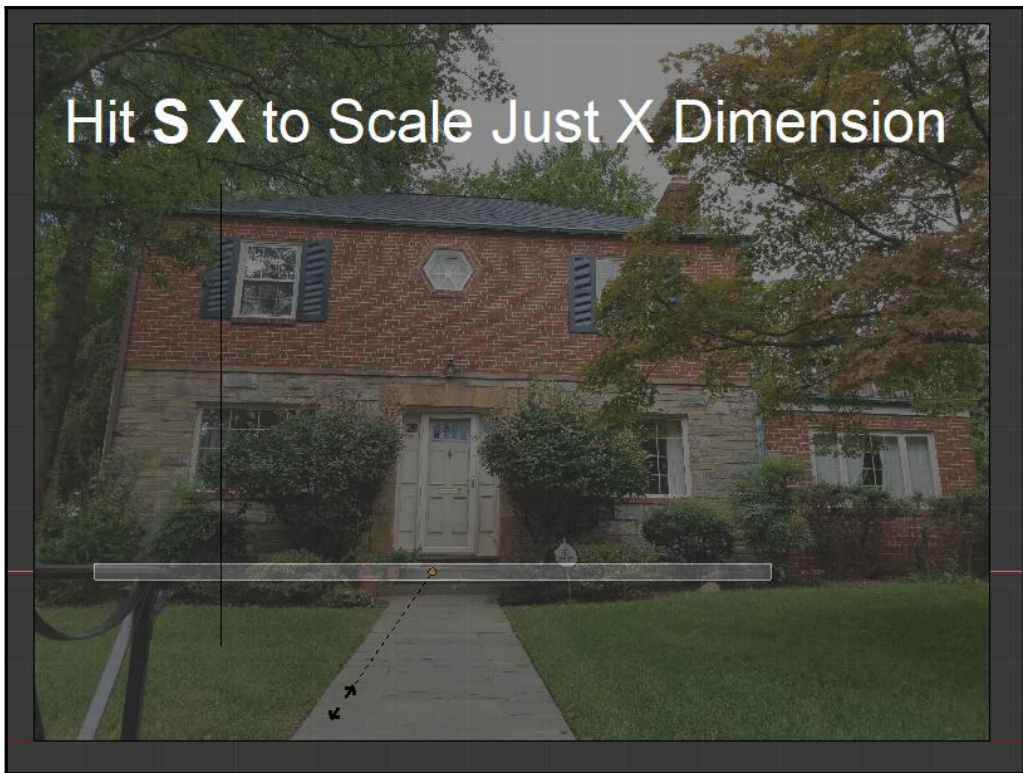

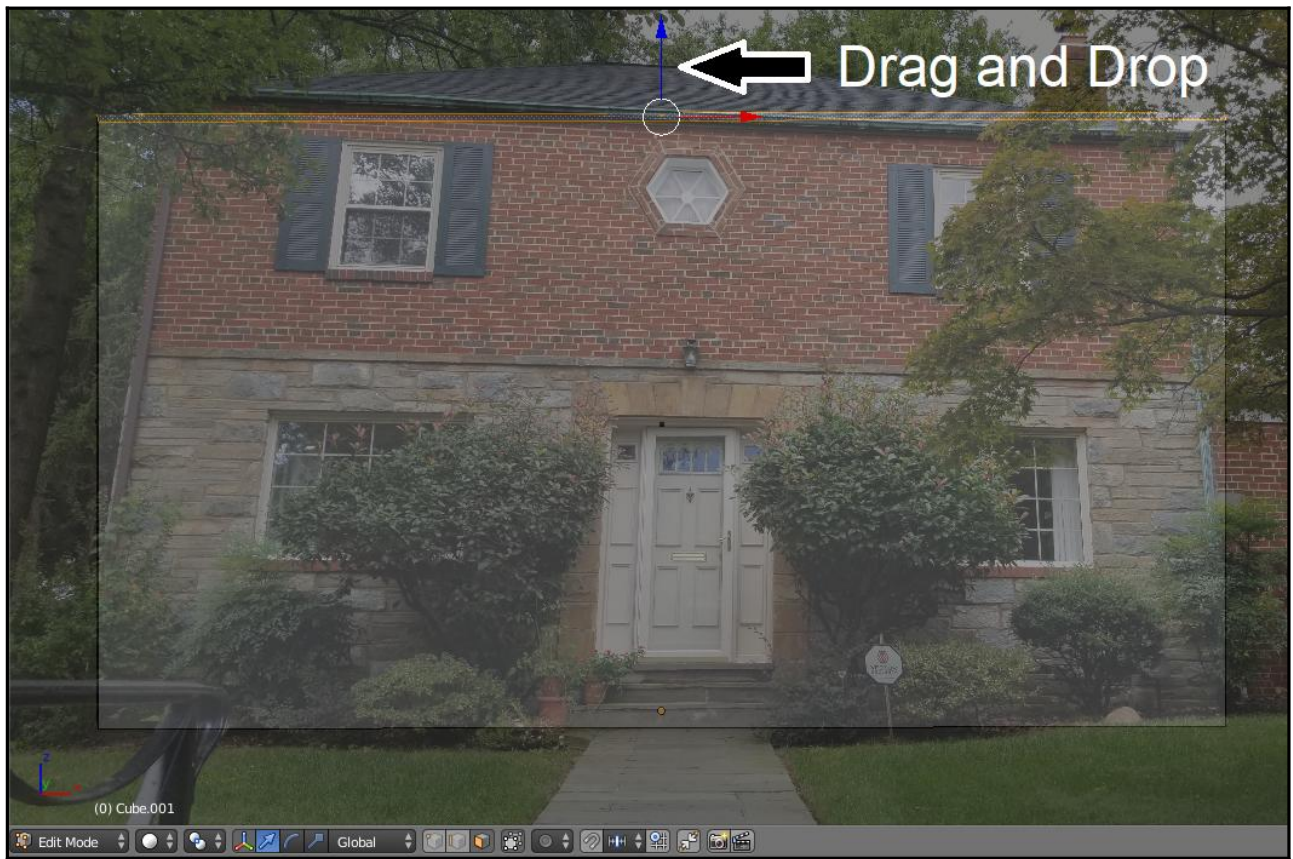
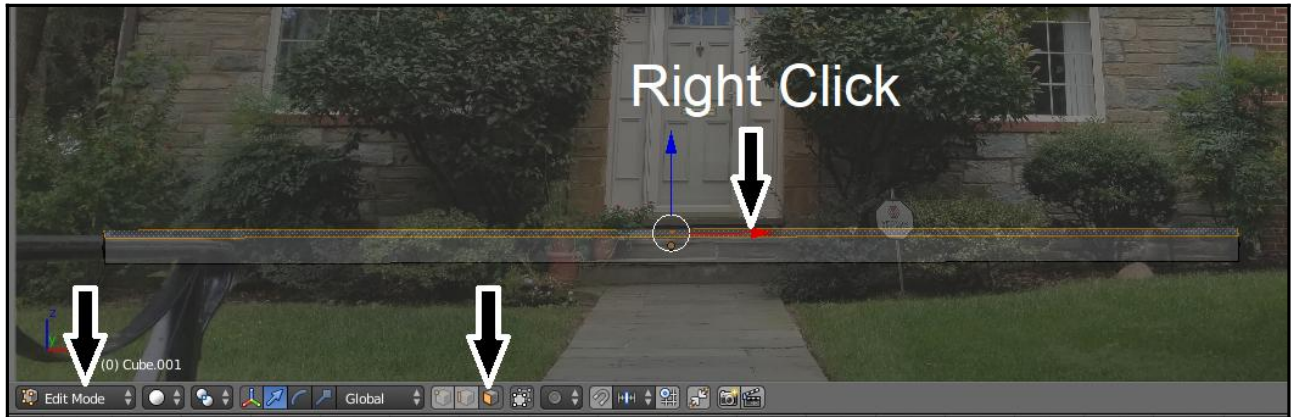





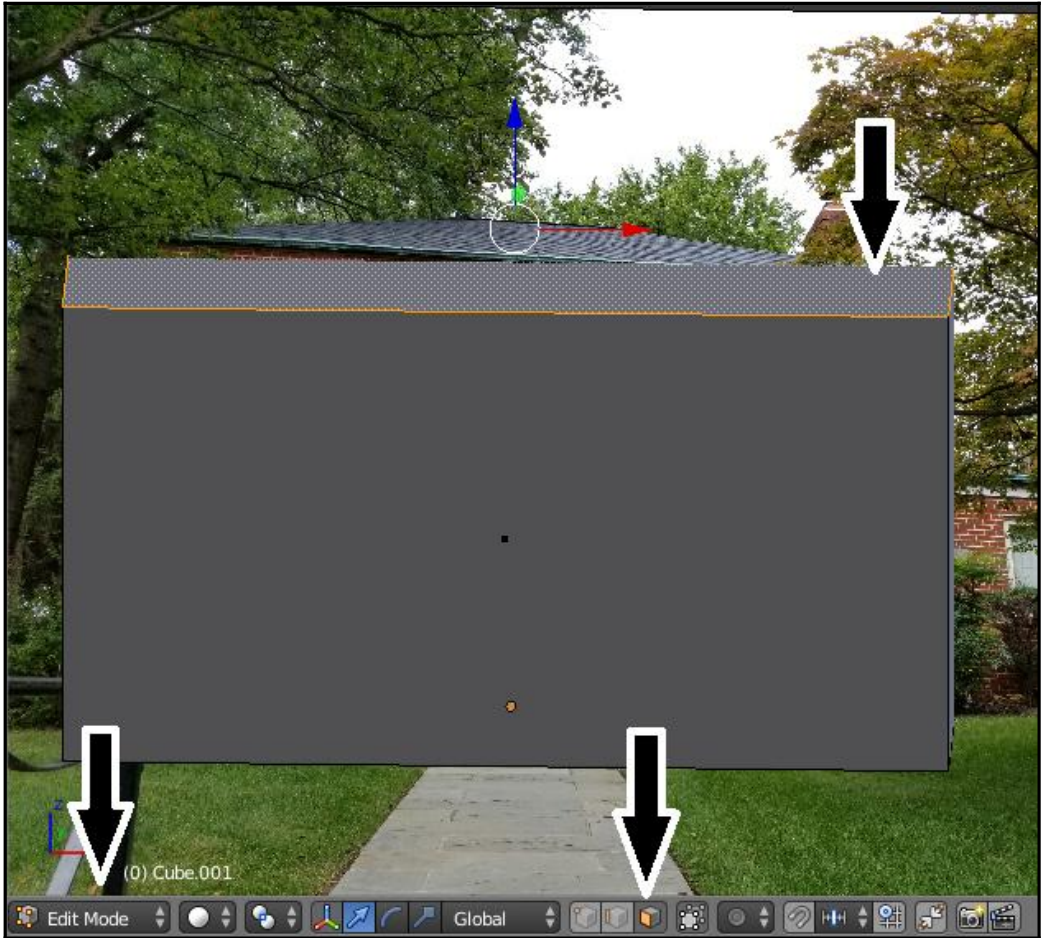

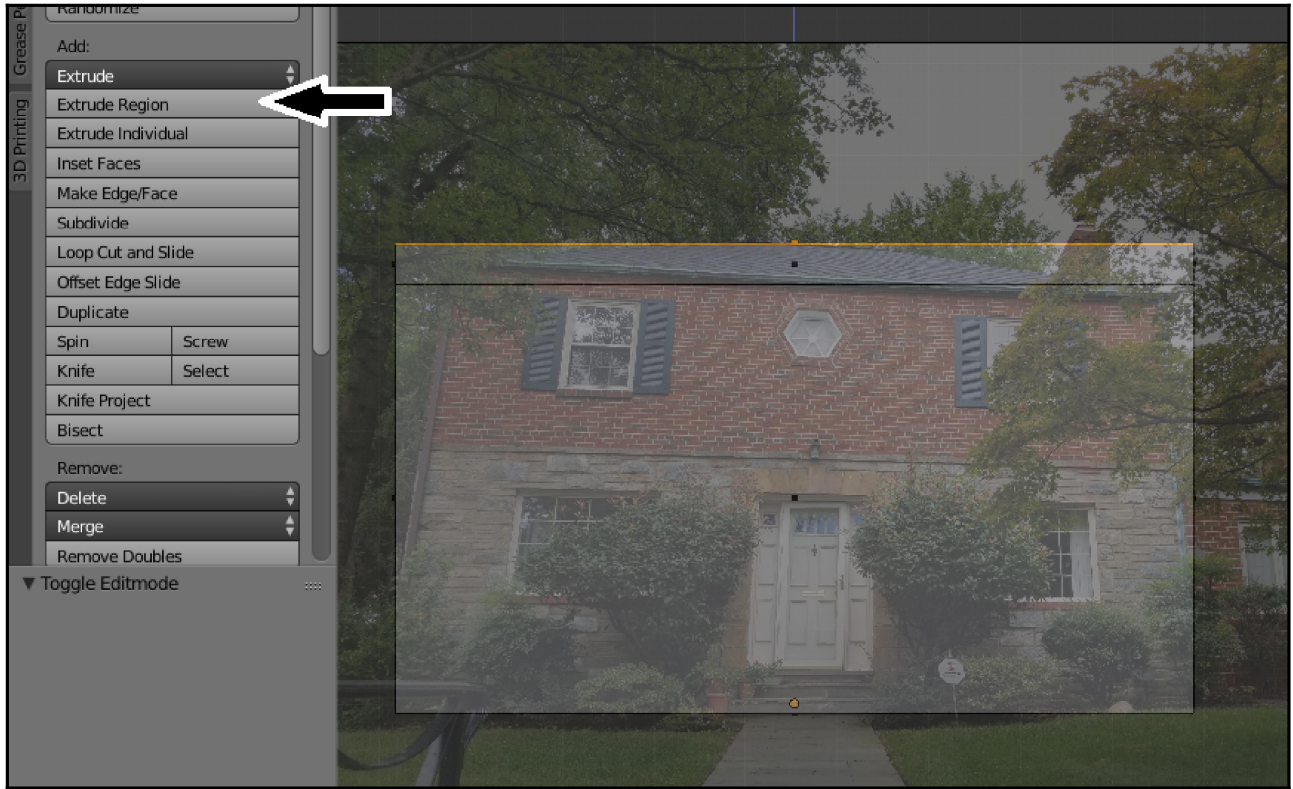

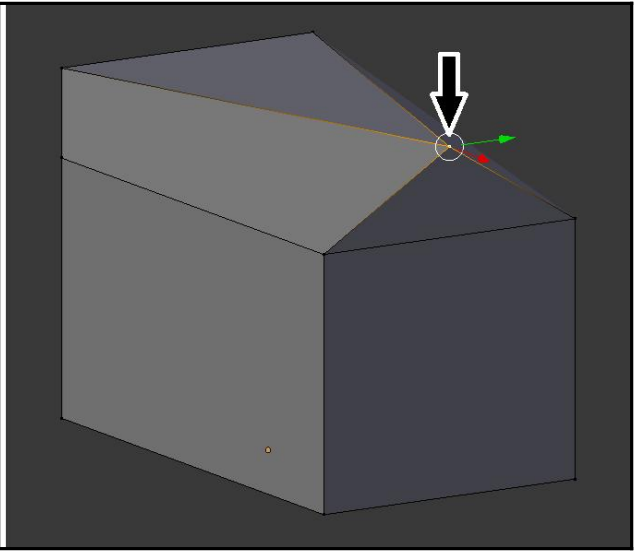
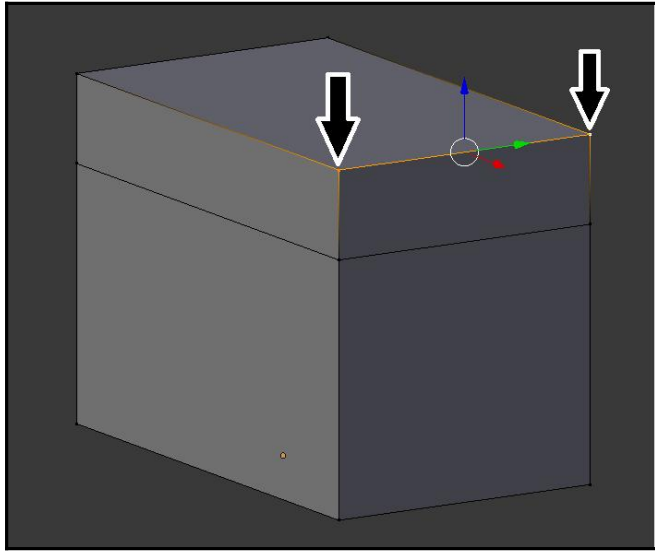

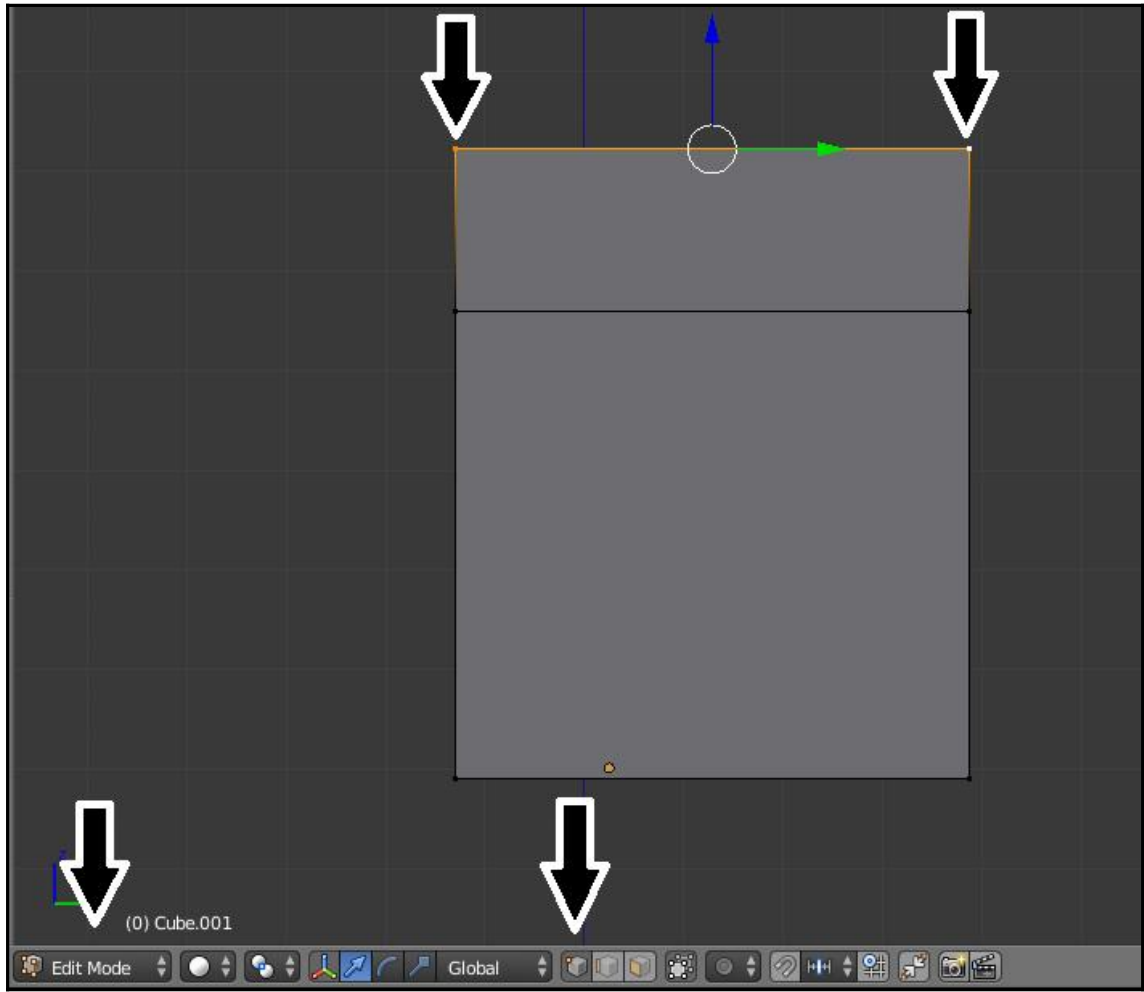



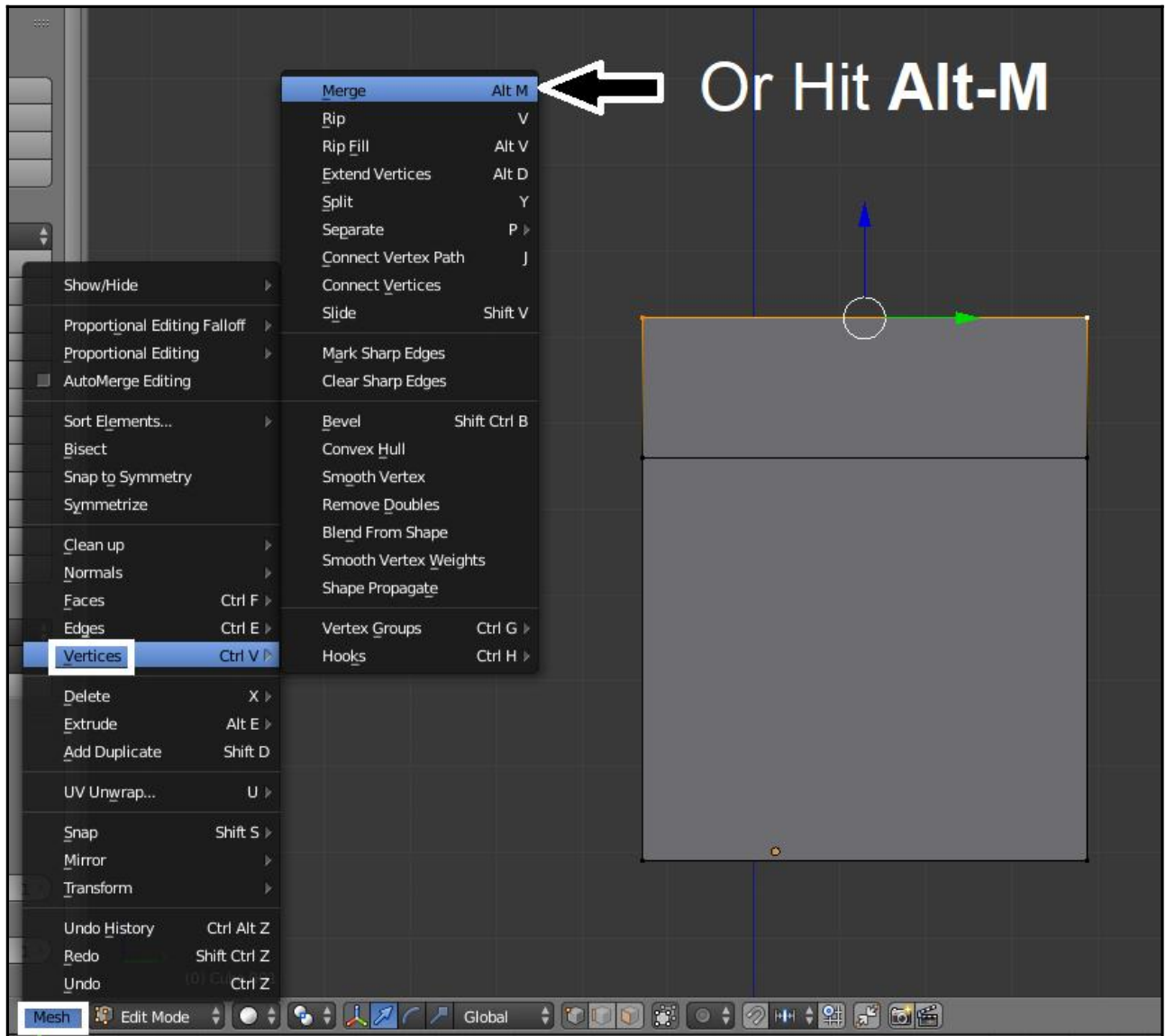

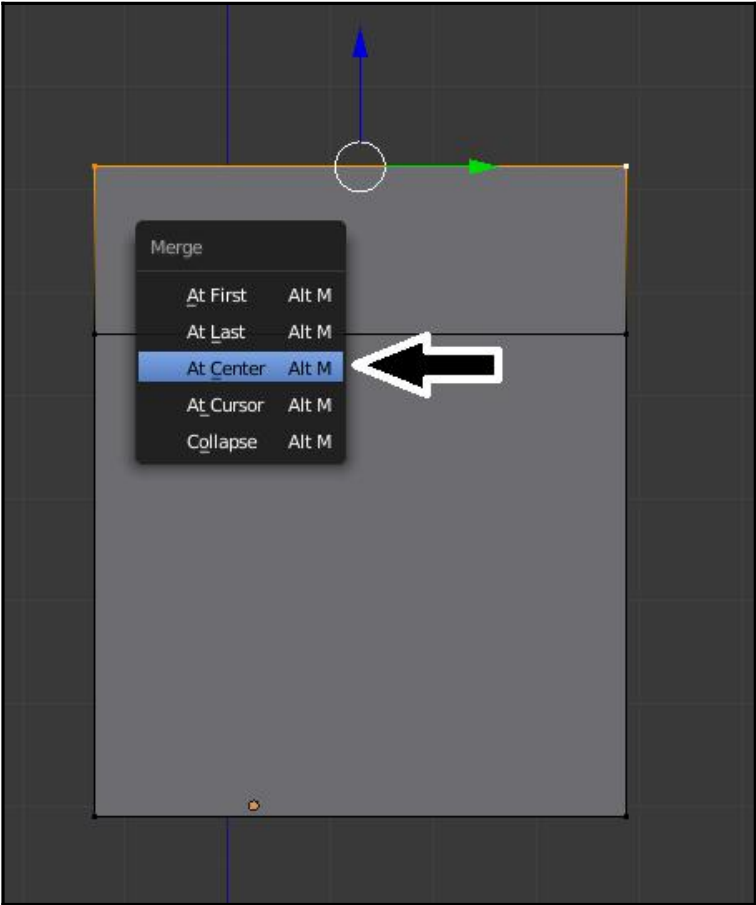

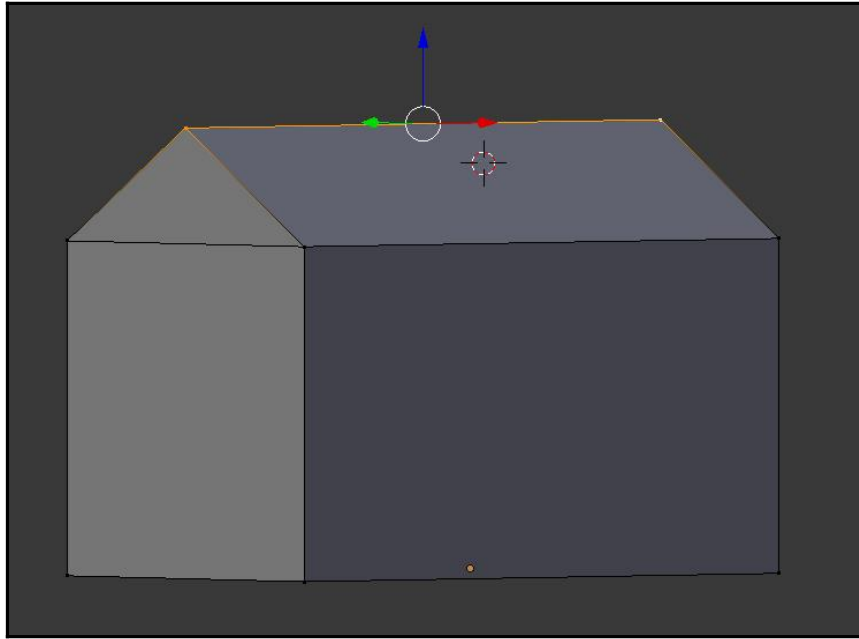

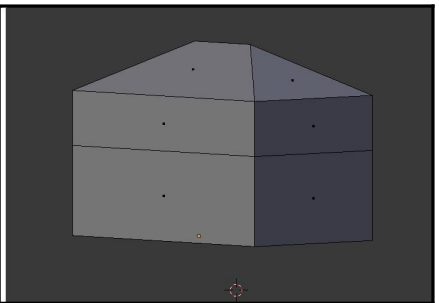
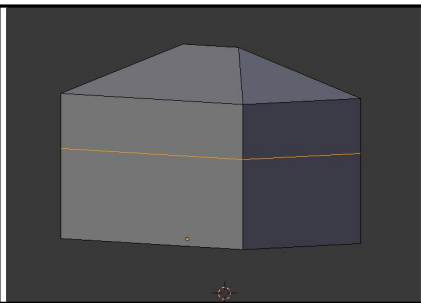
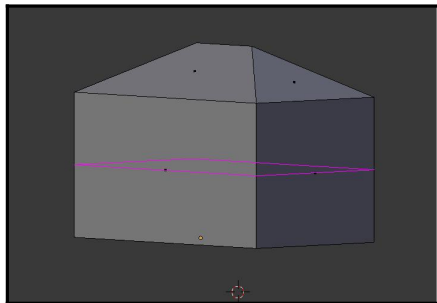
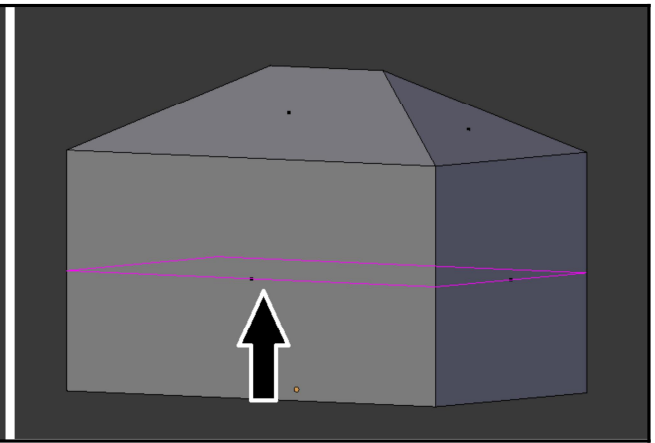
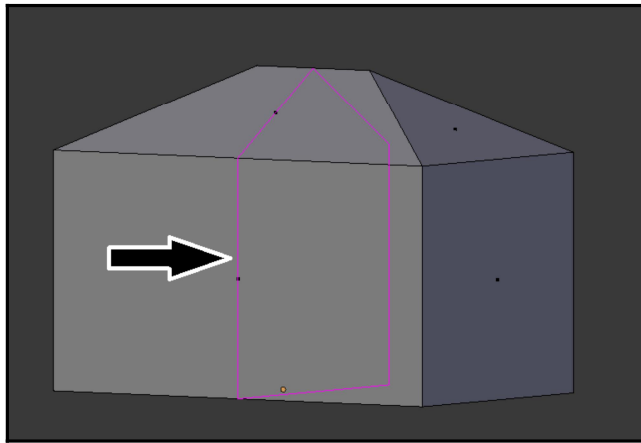
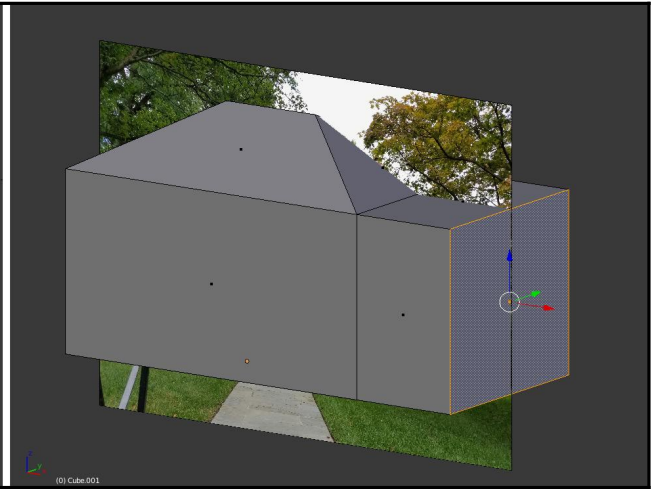
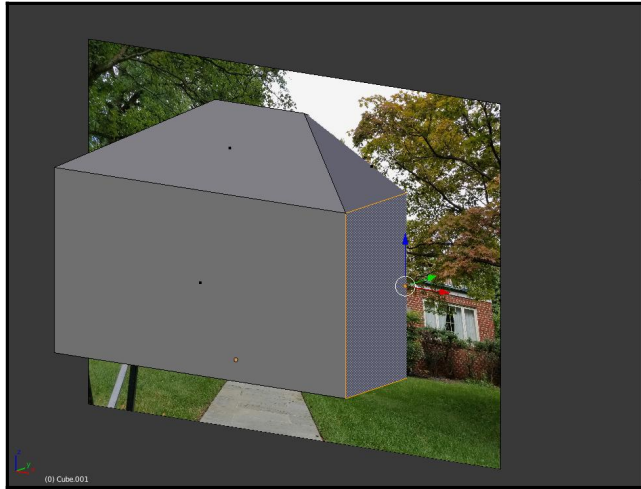

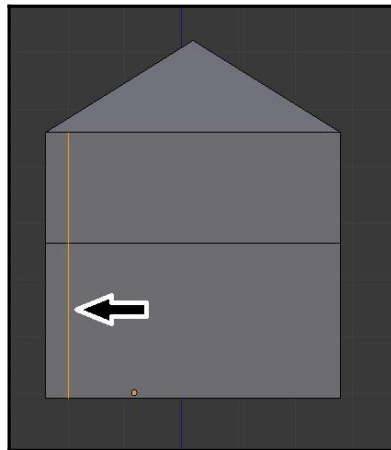
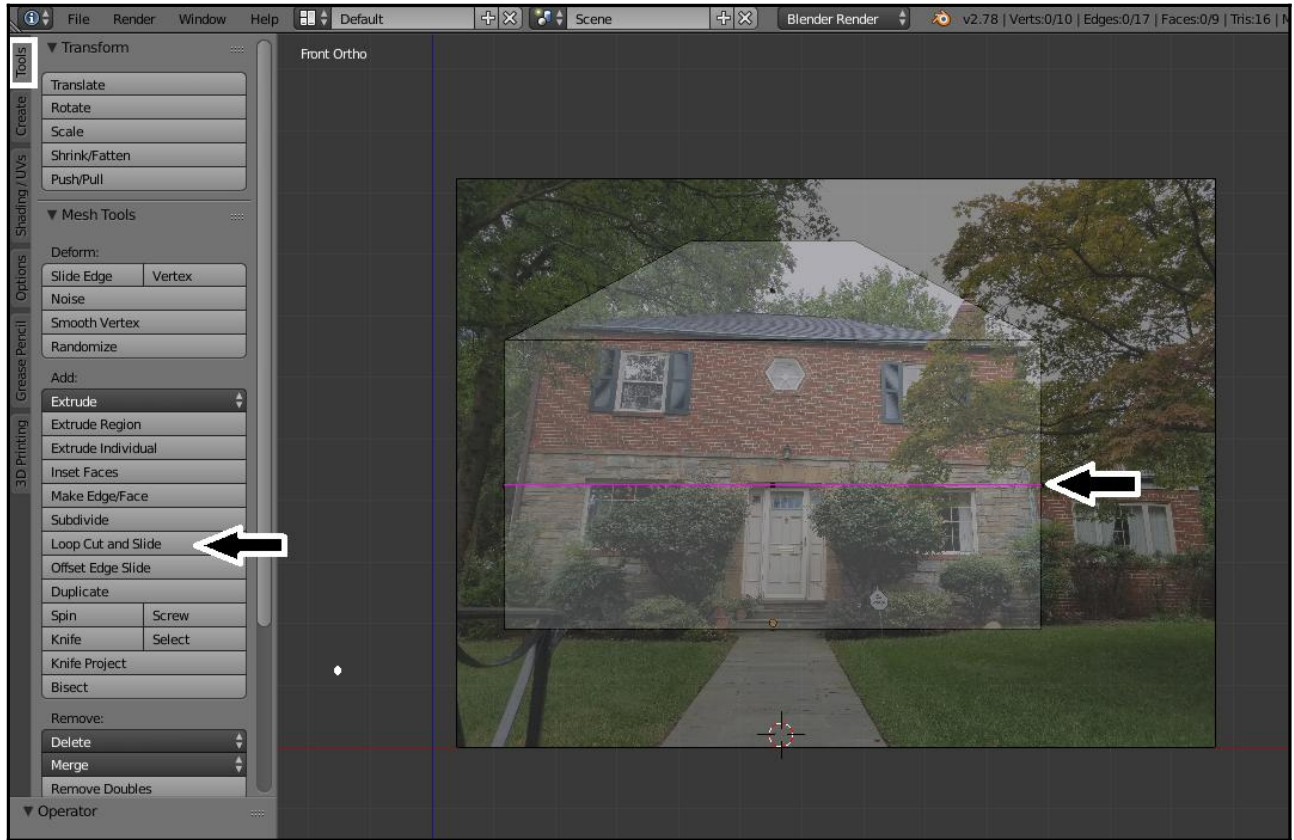

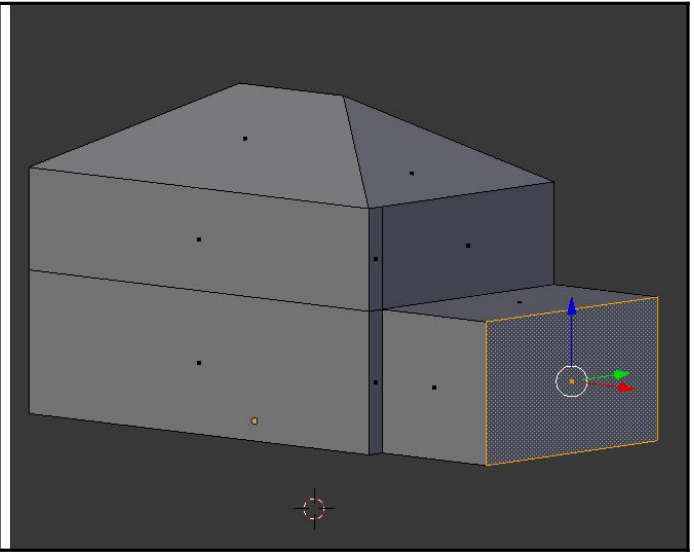
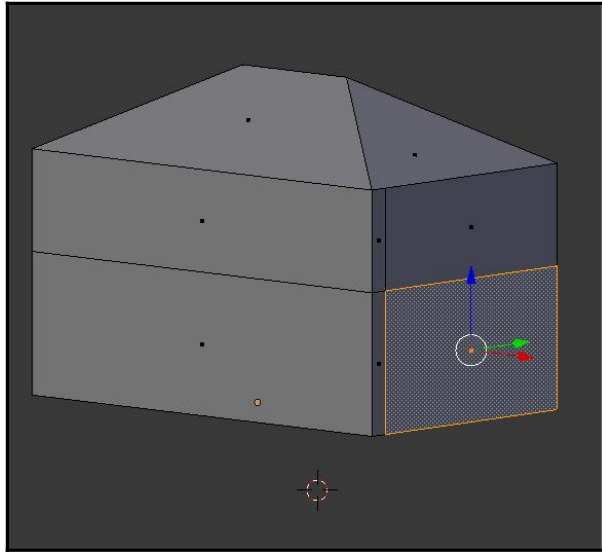

# Chapter 9: Mesh Modeling and Positioning the Details

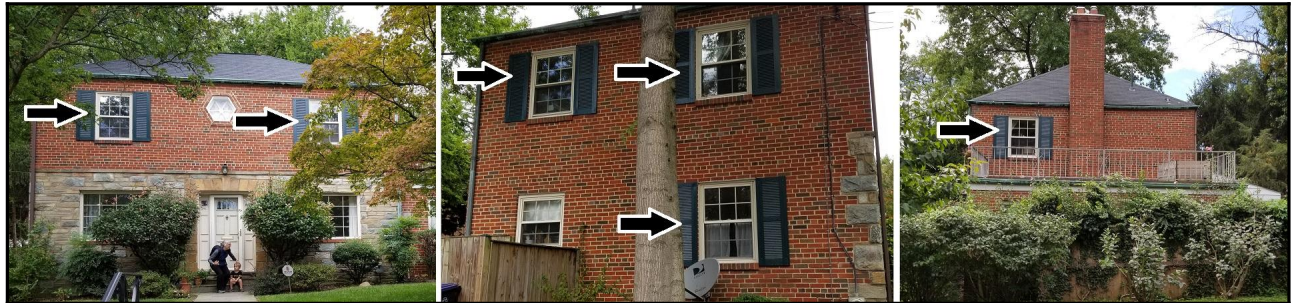
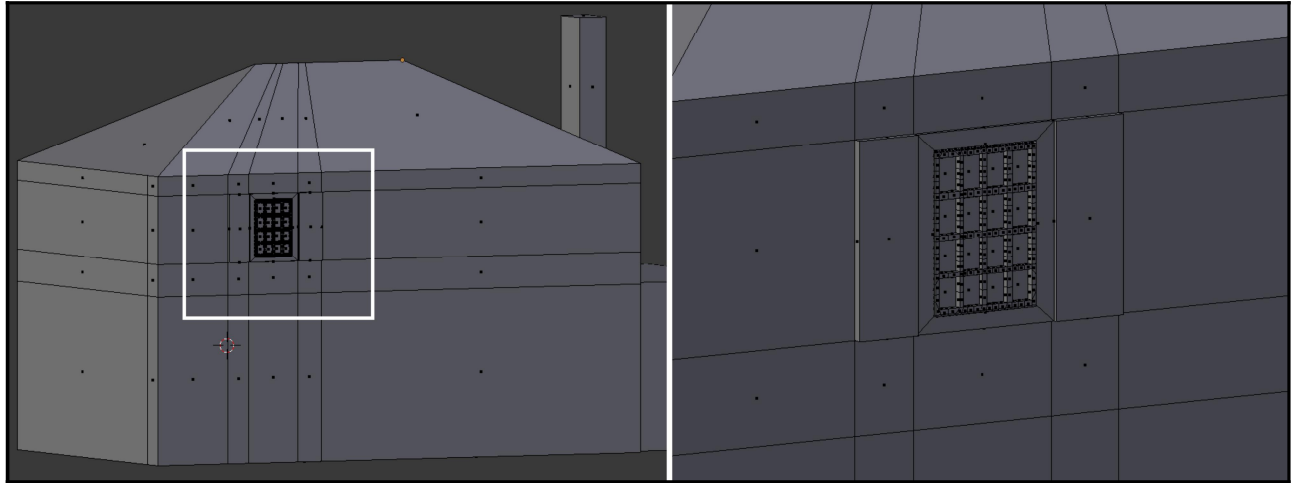

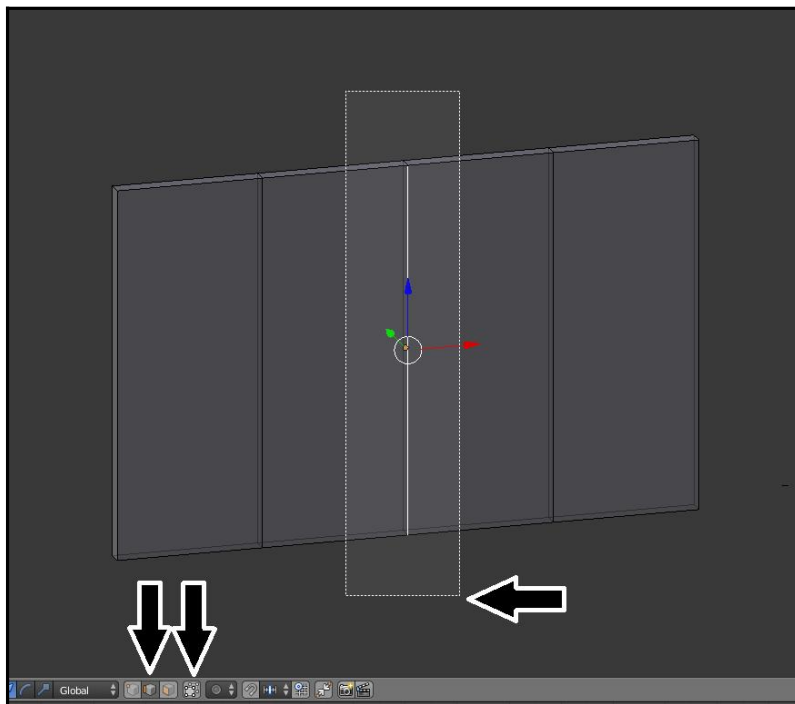
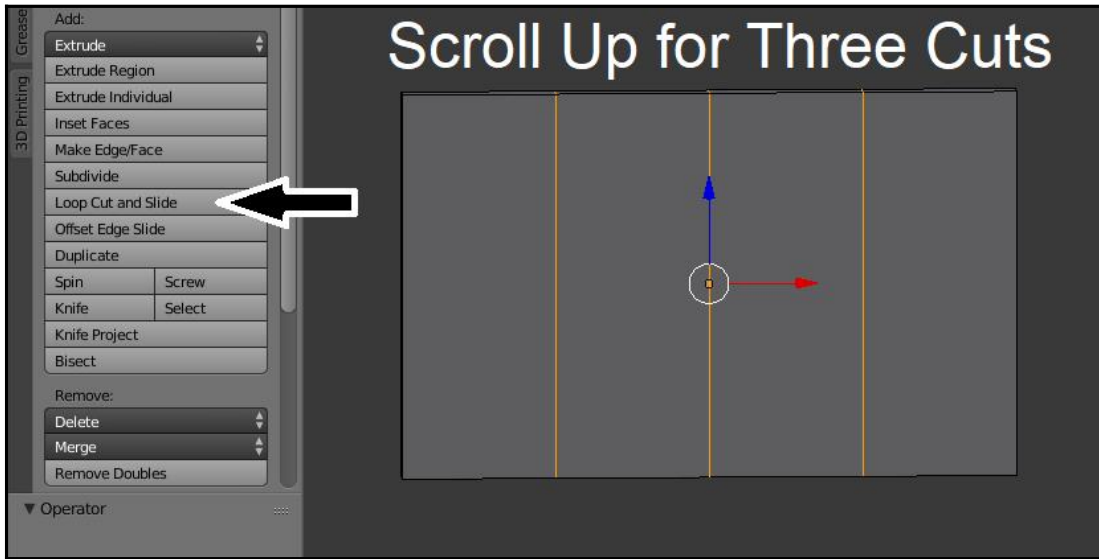



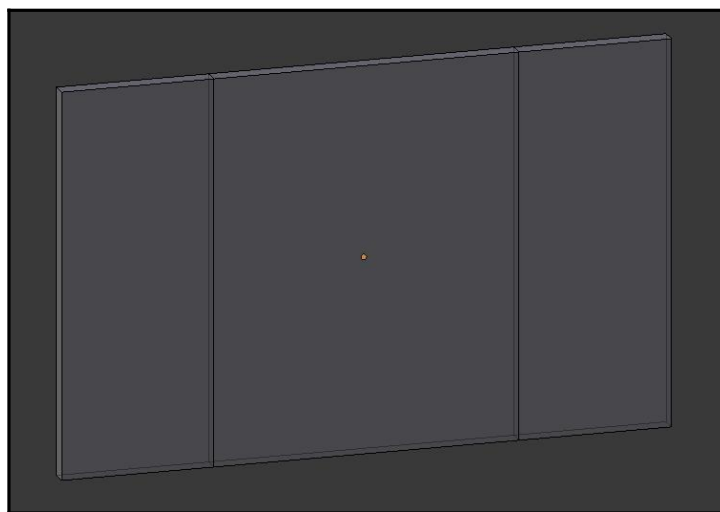
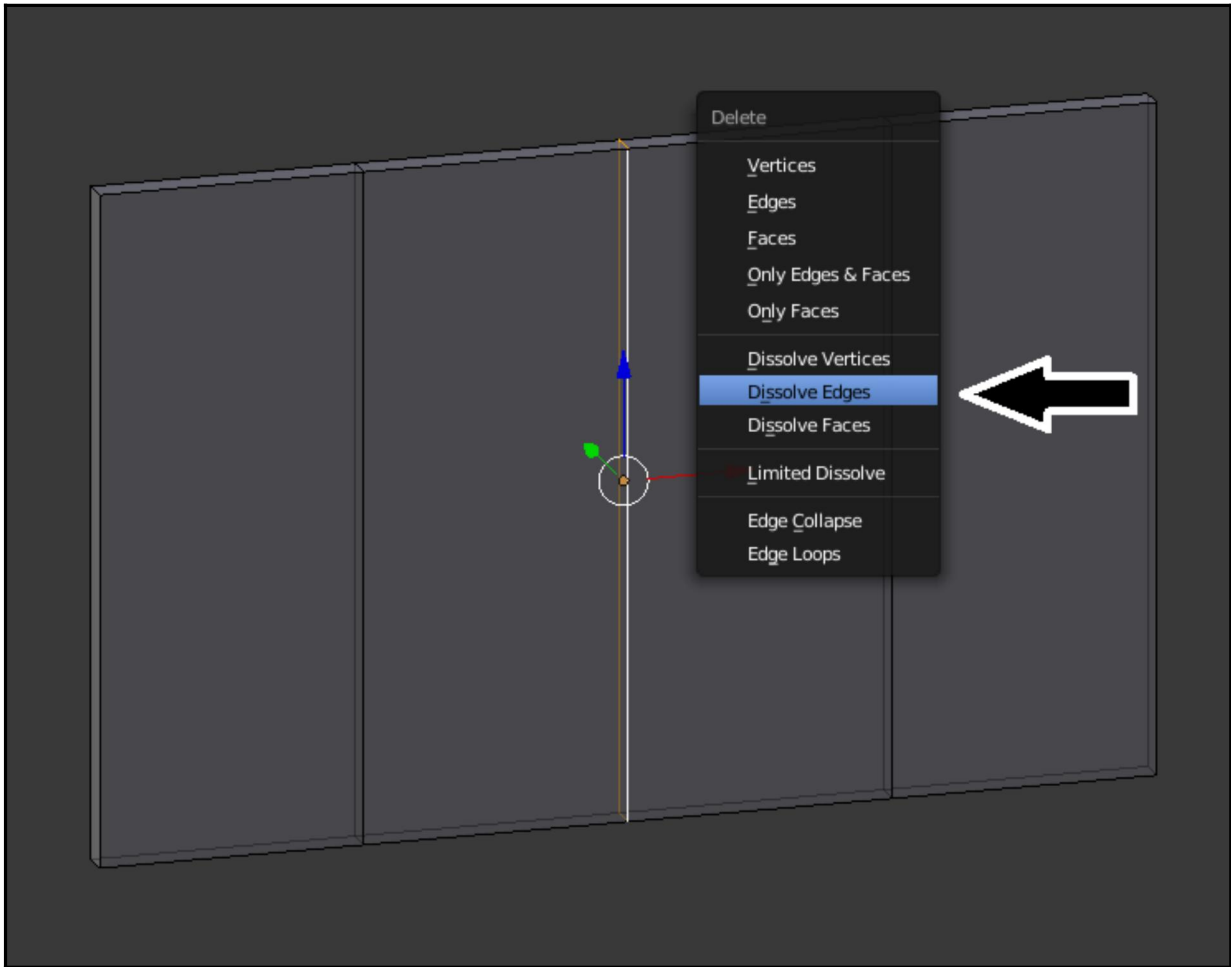

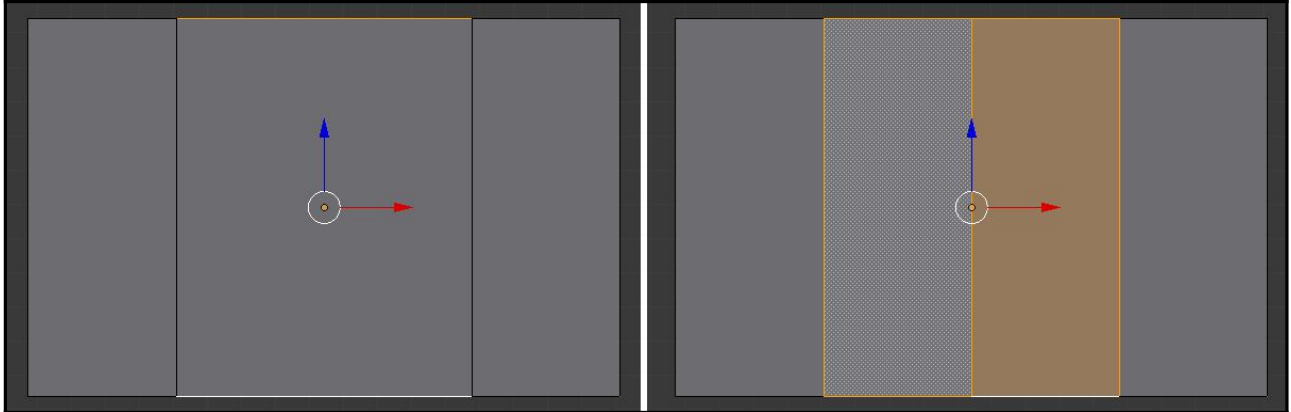
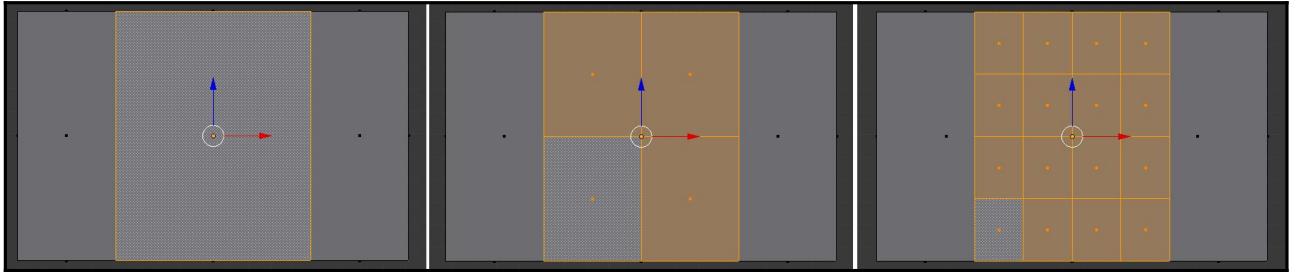
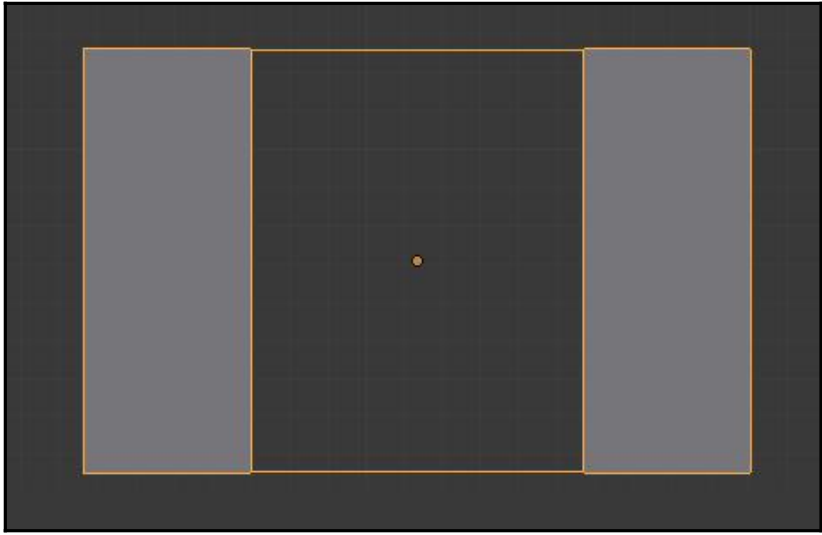

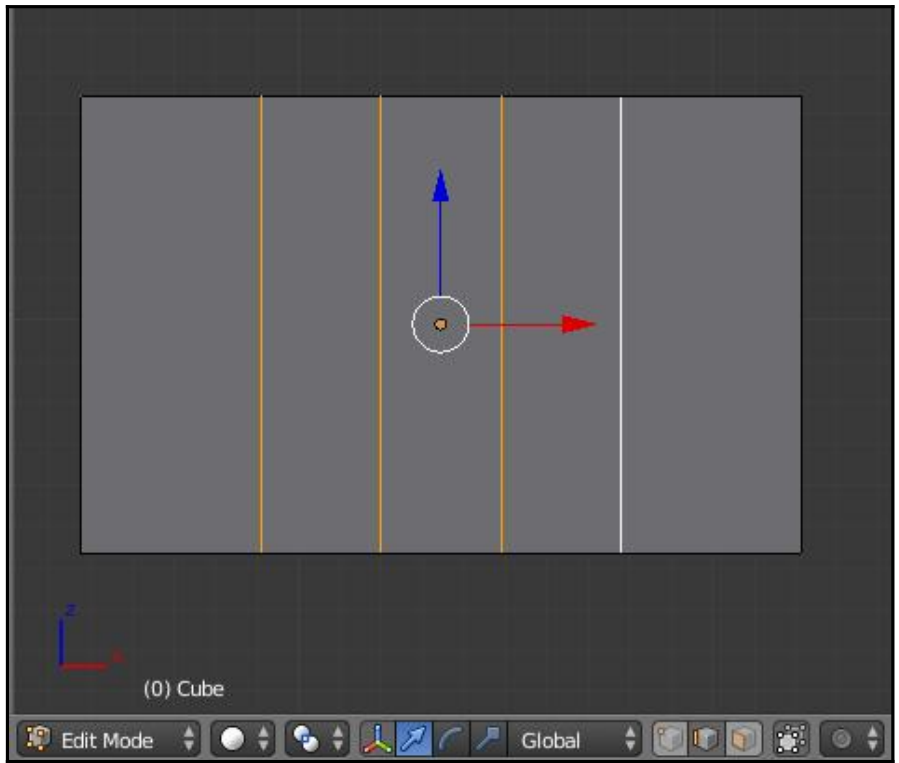
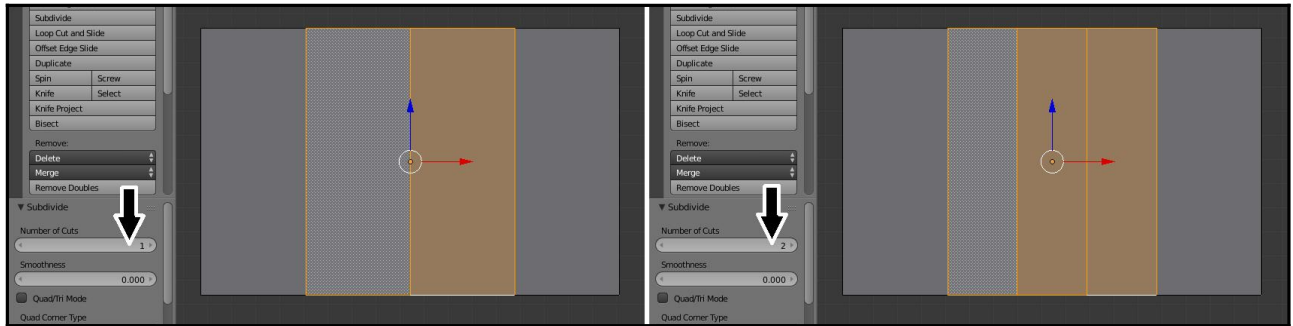

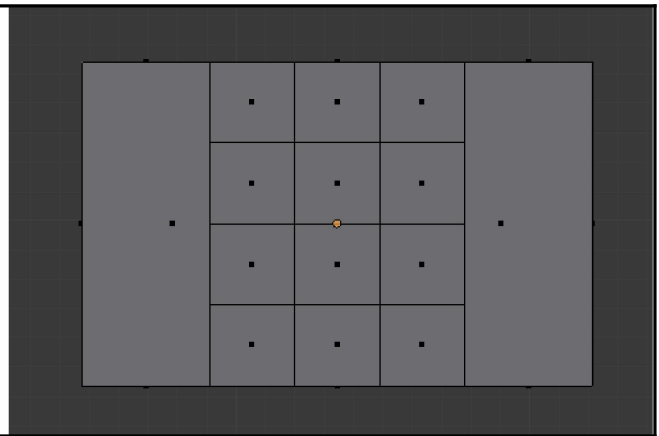
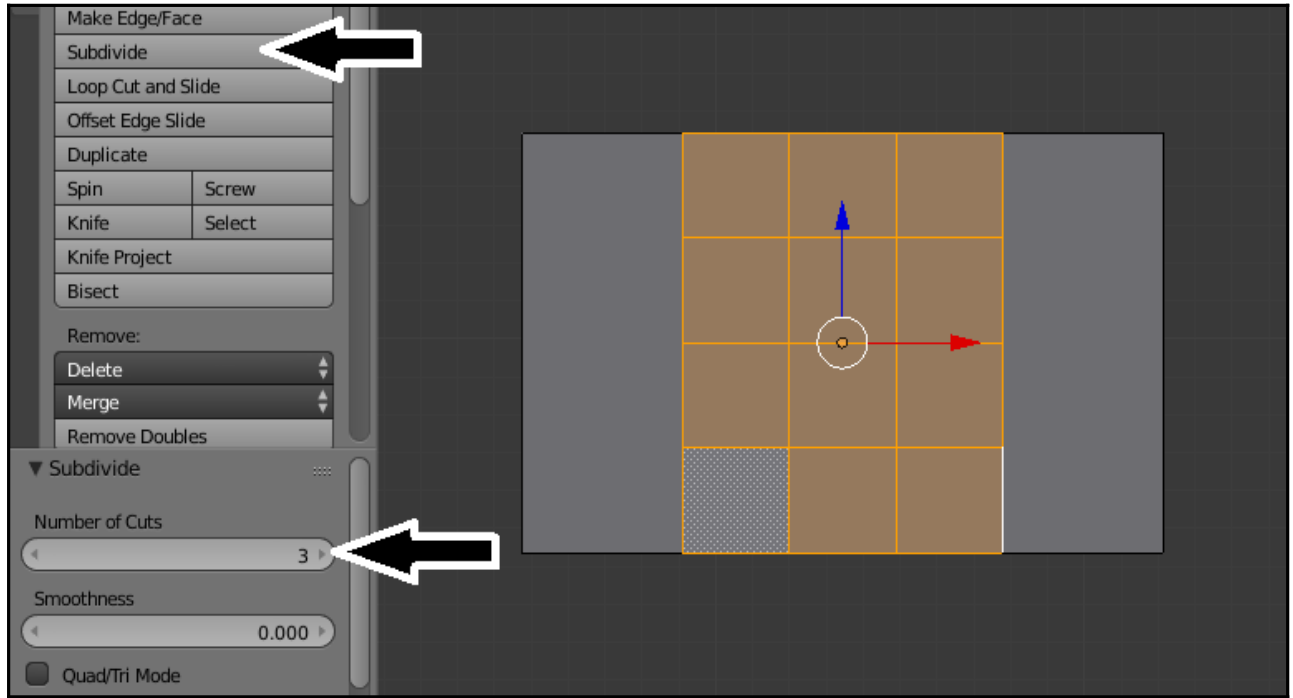

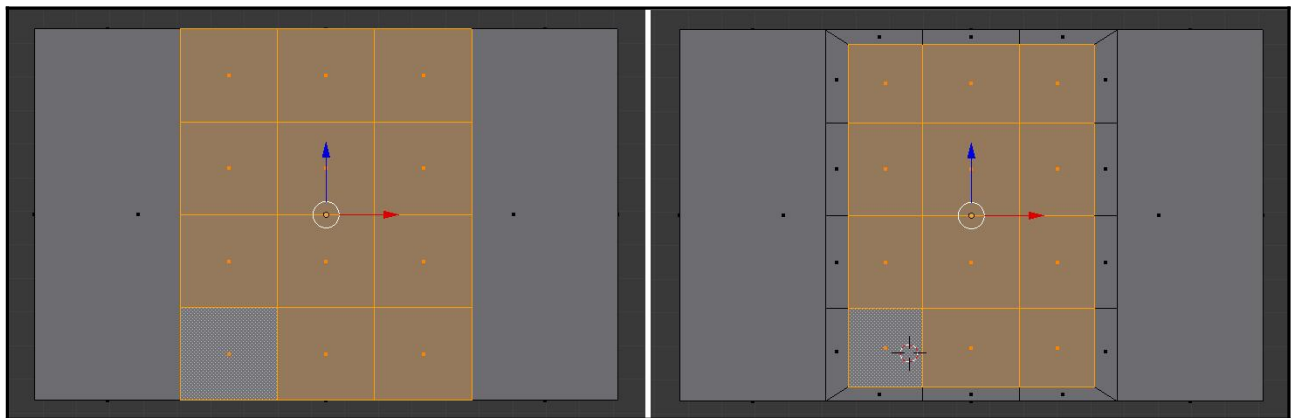
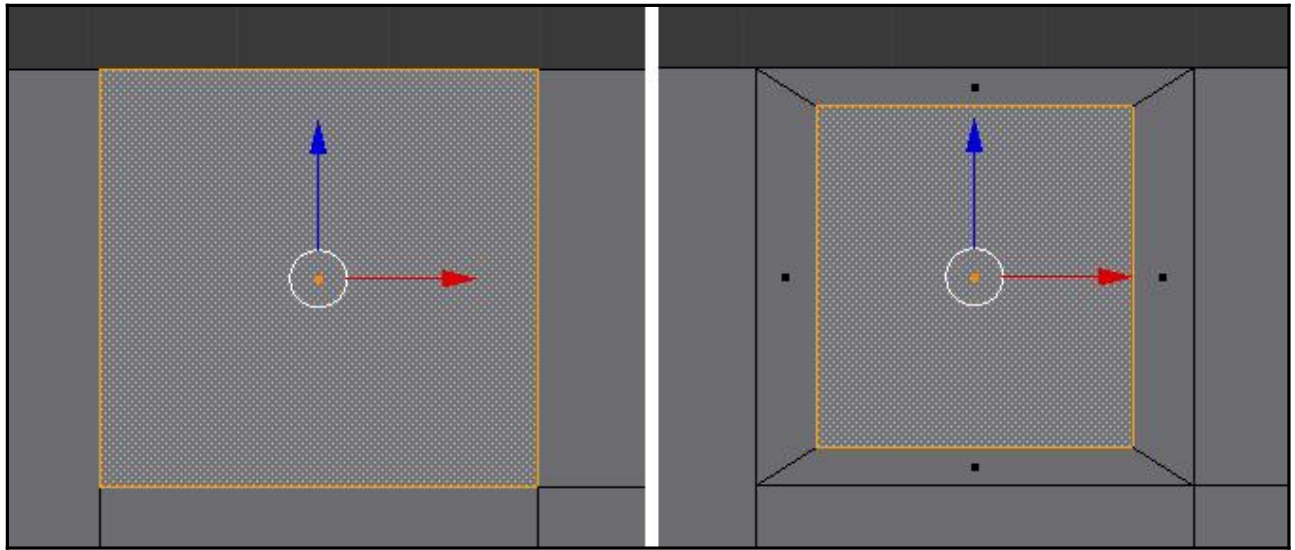

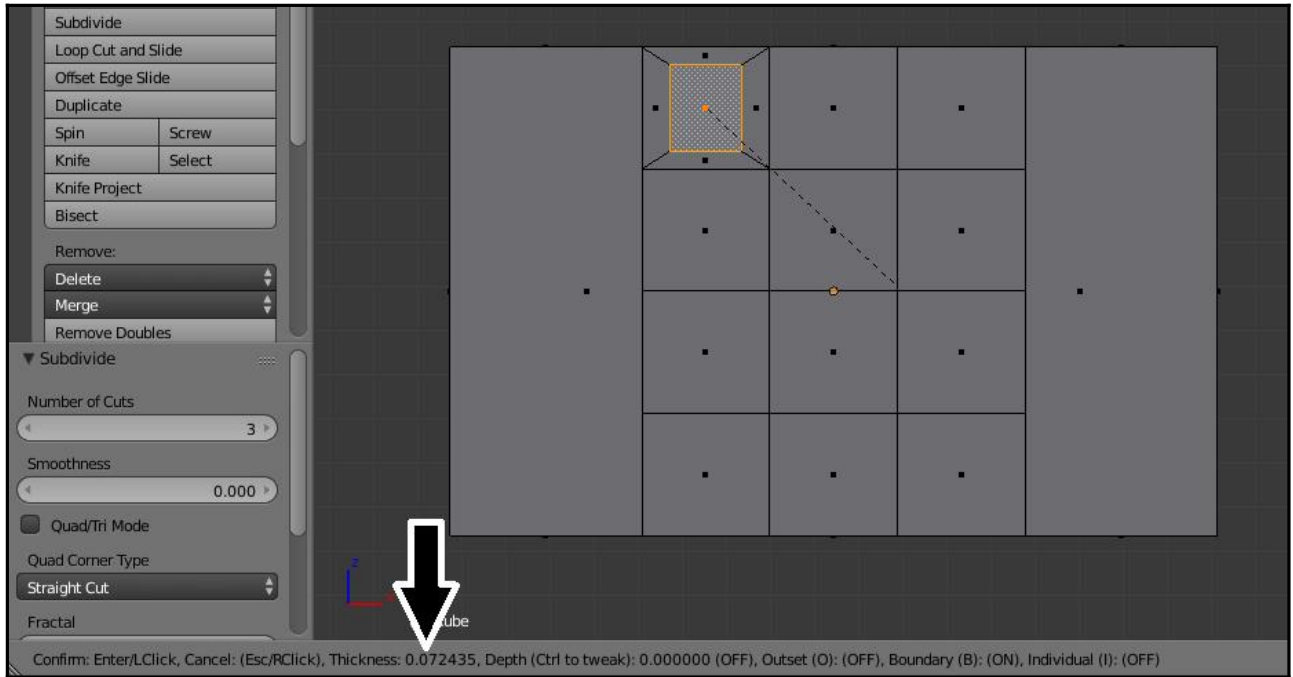

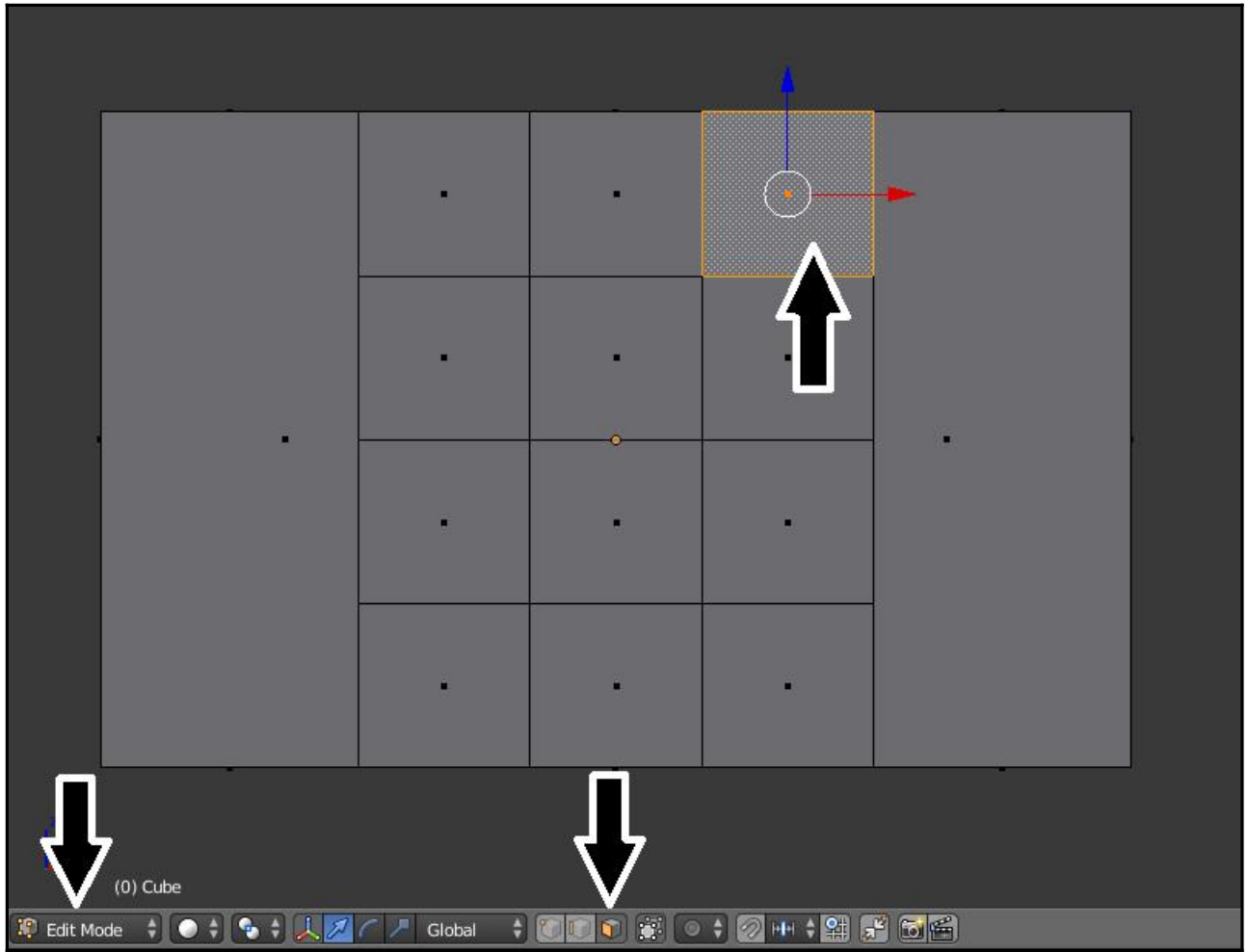

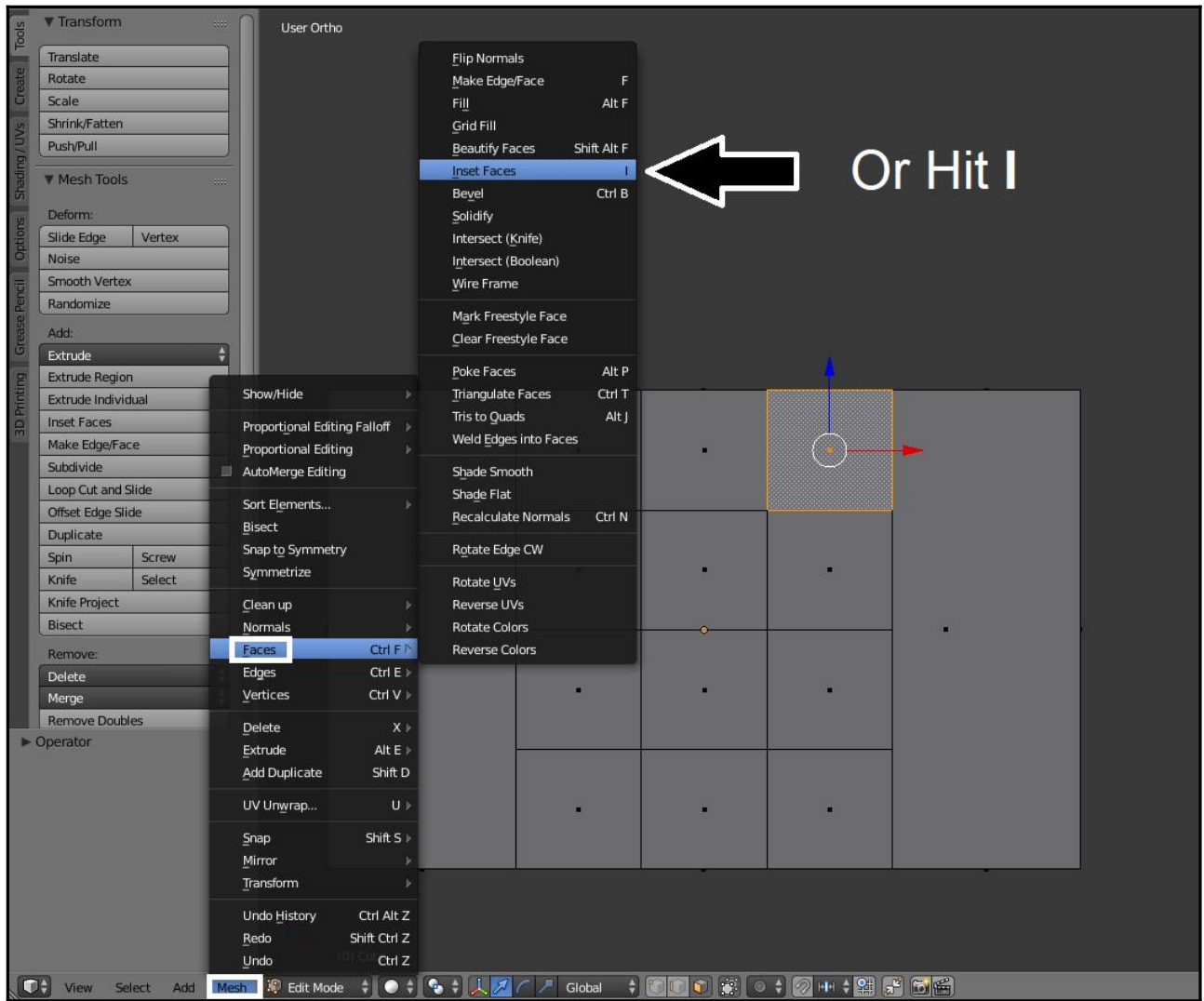



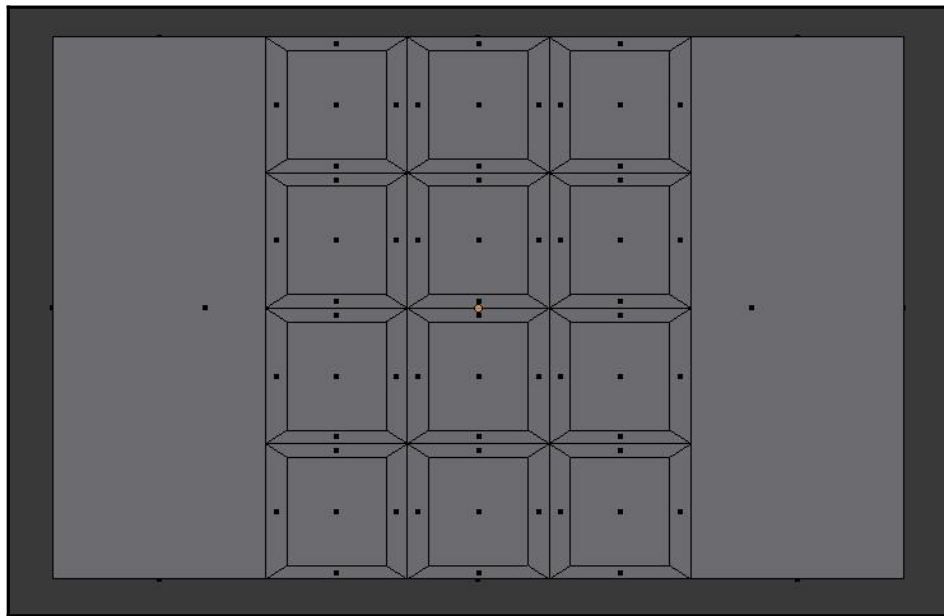
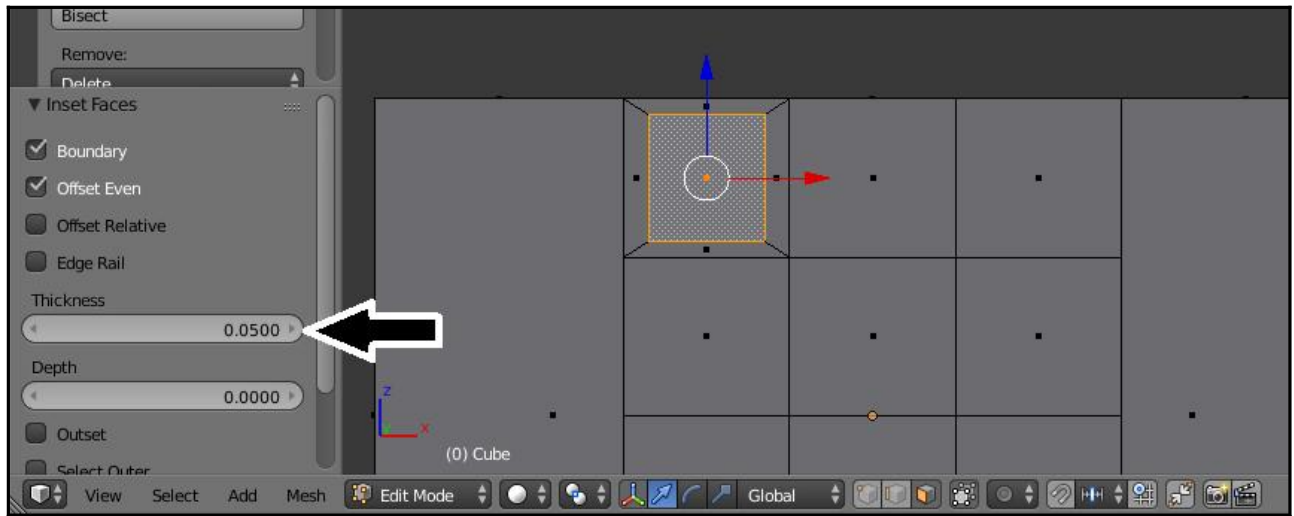

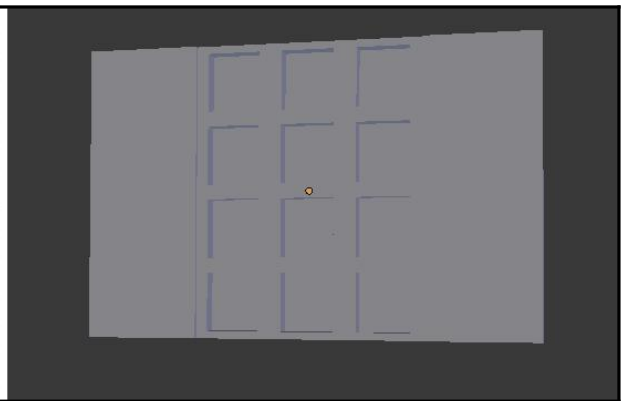
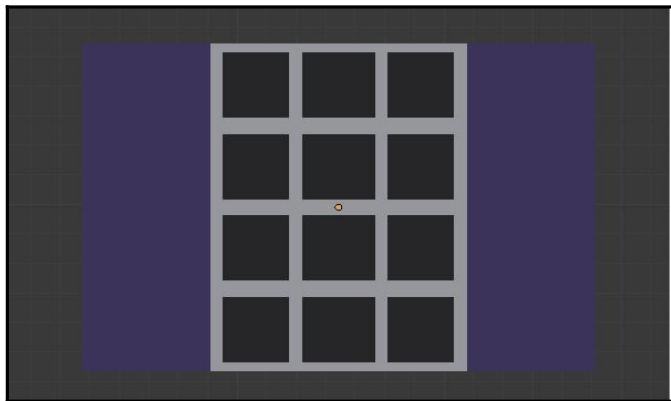
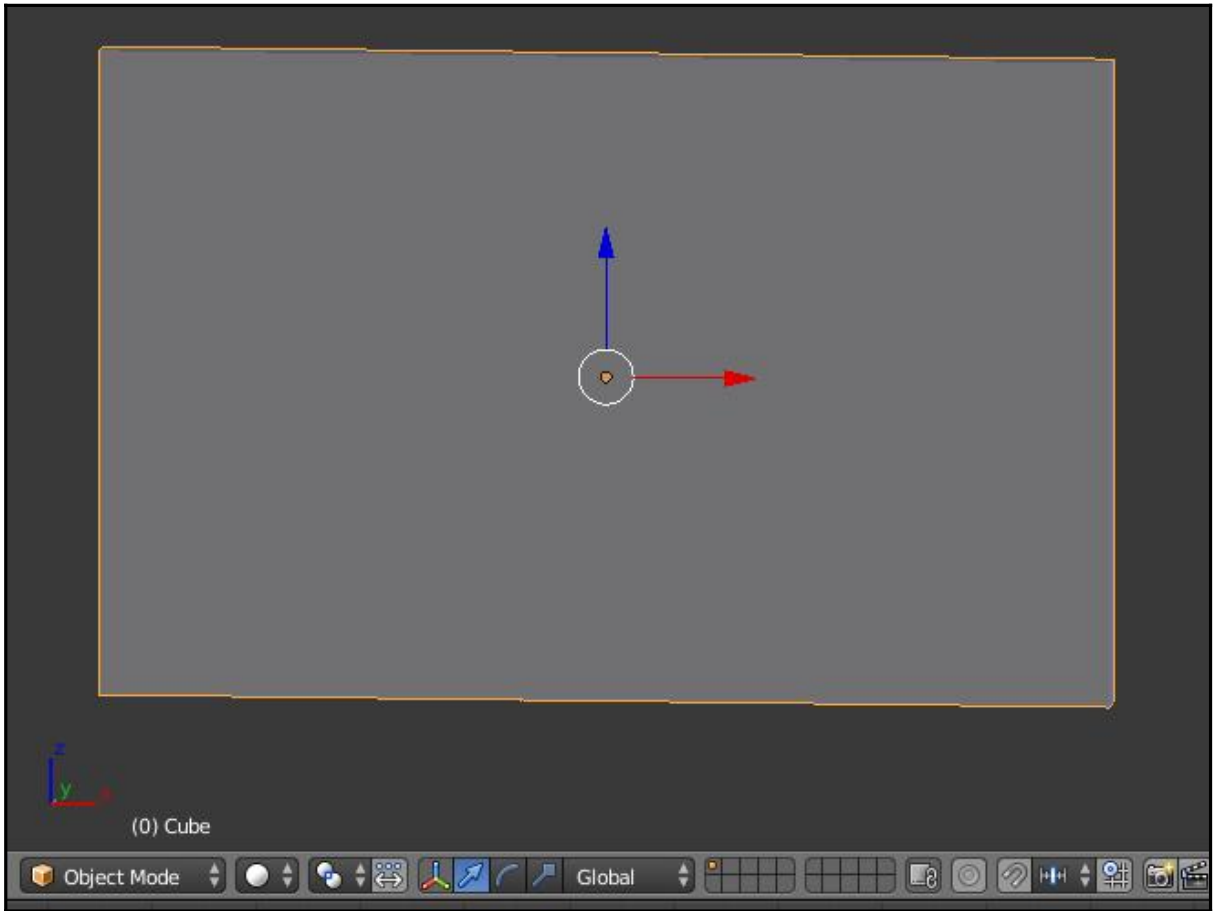

# Shift Right Click

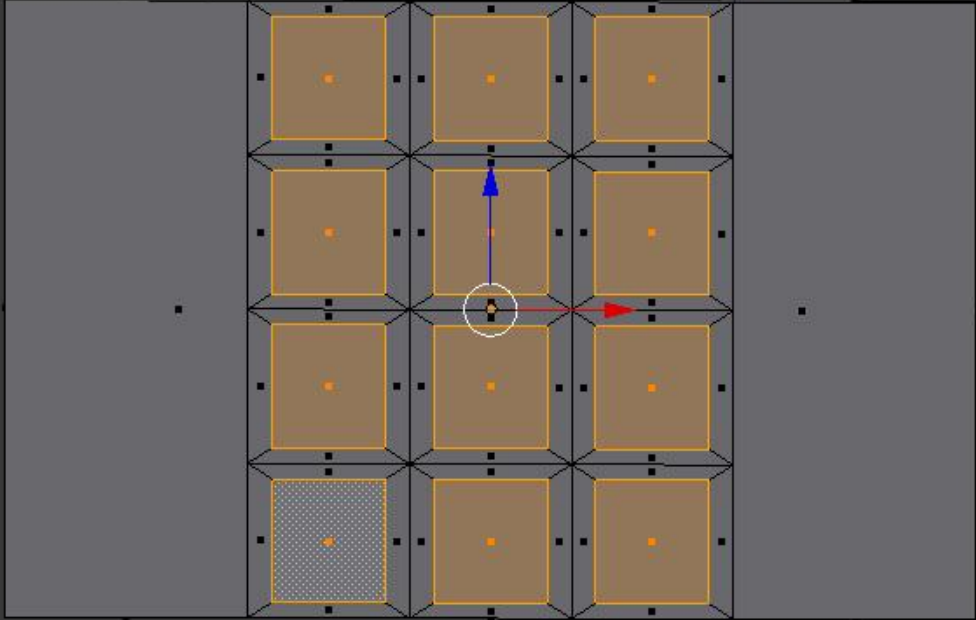

(0) Cube

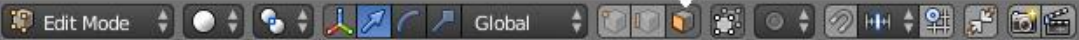

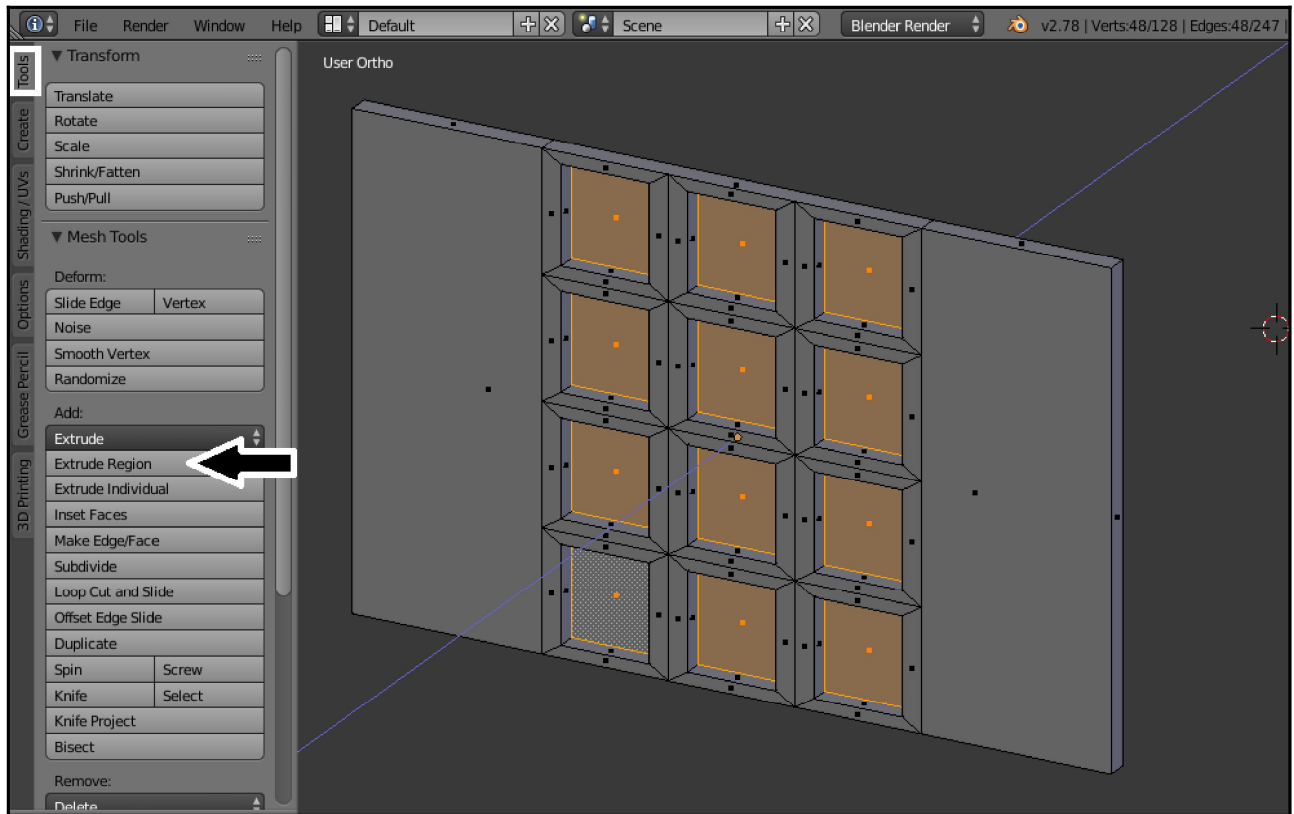

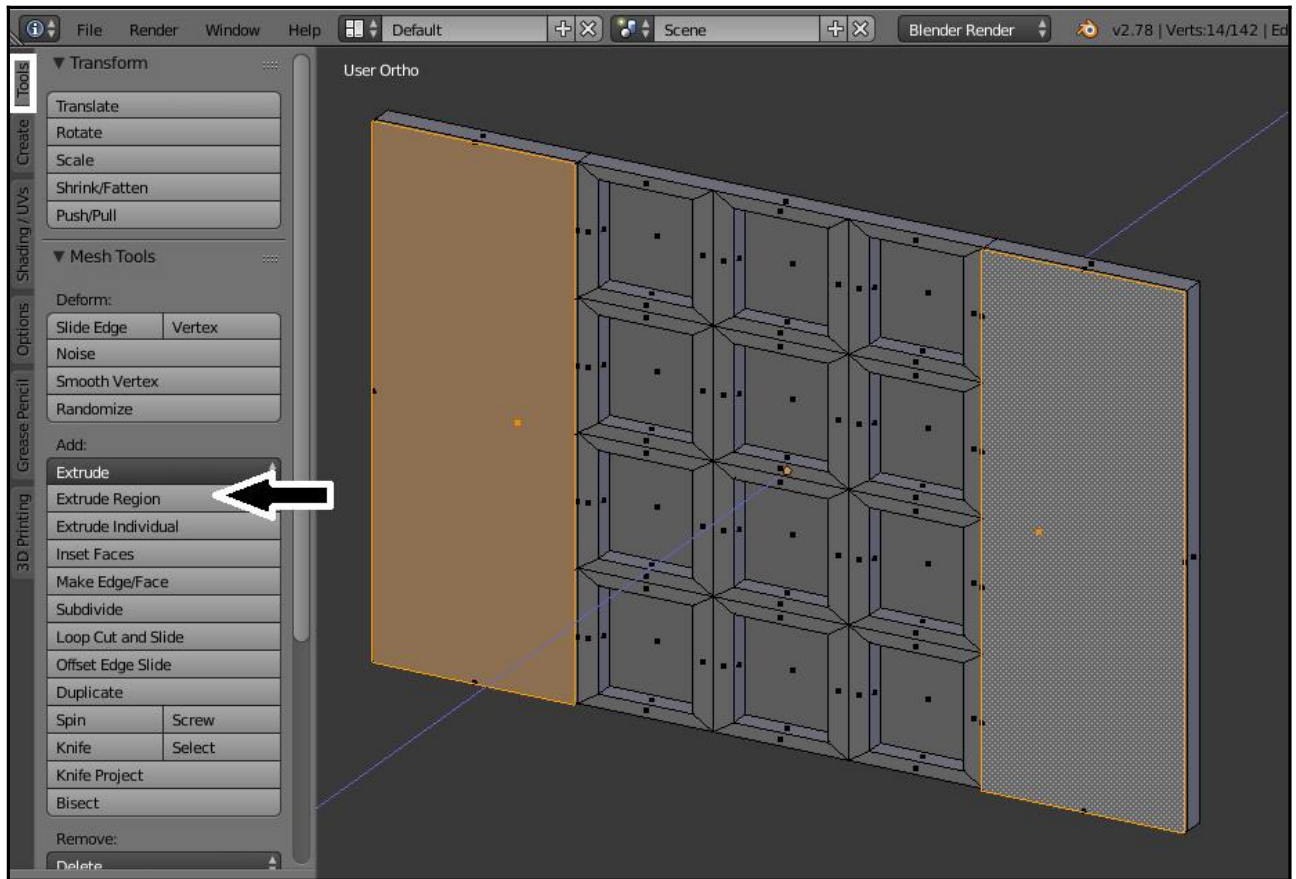

User Ortho

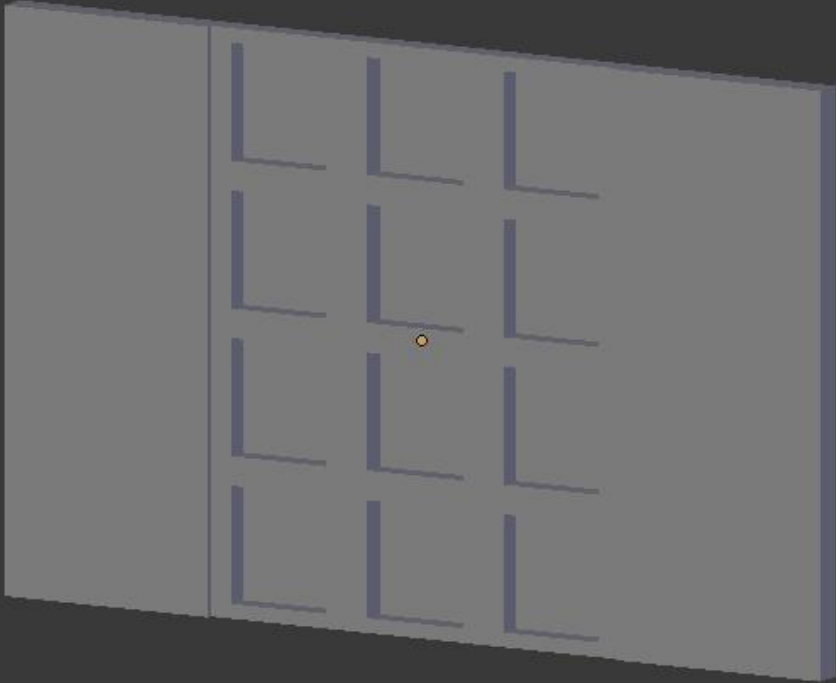

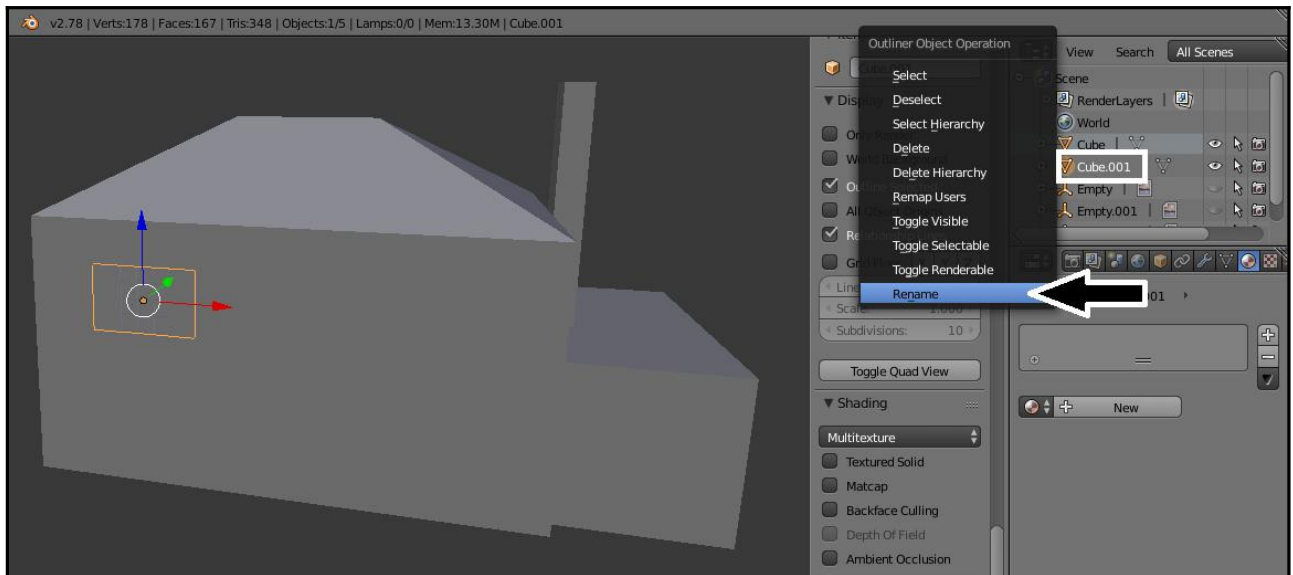
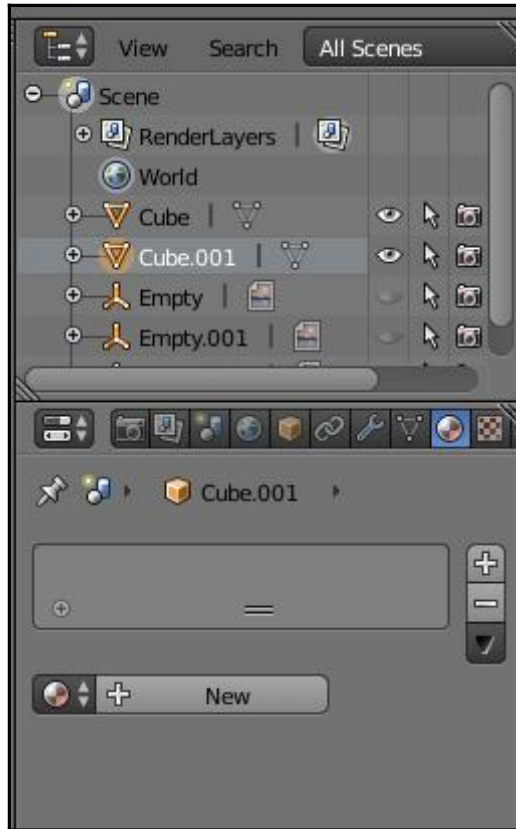

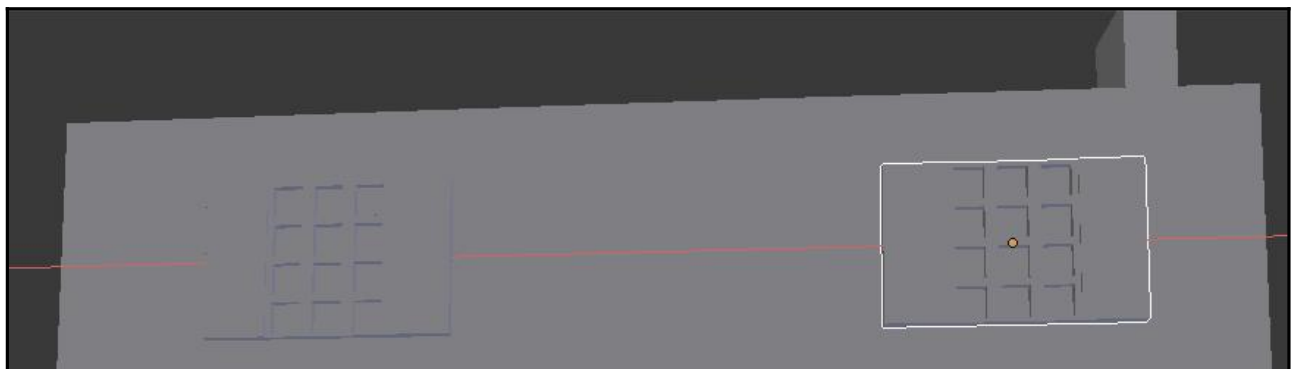
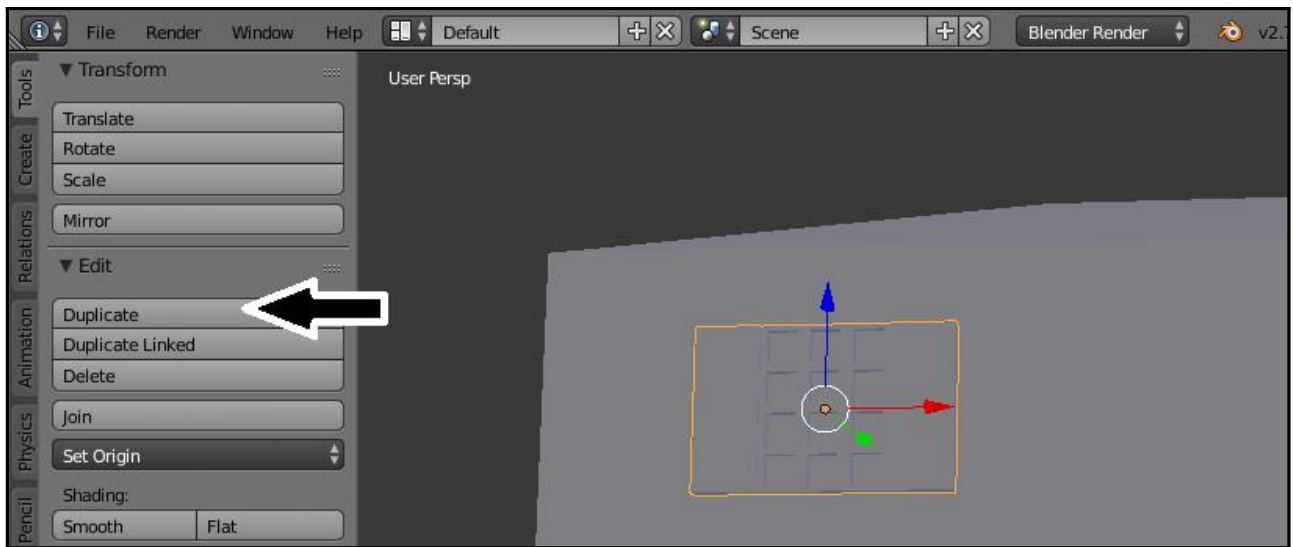
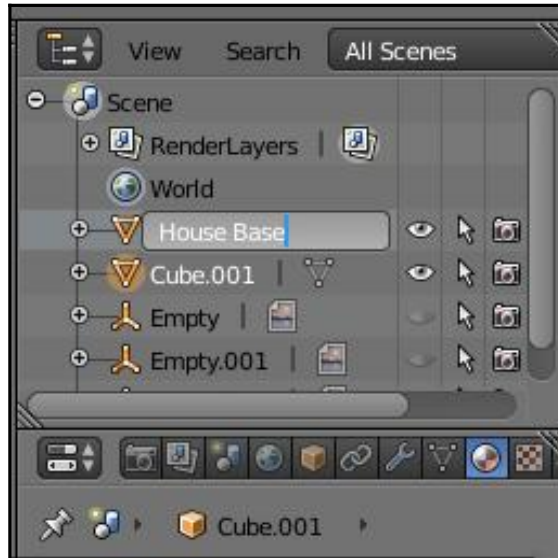



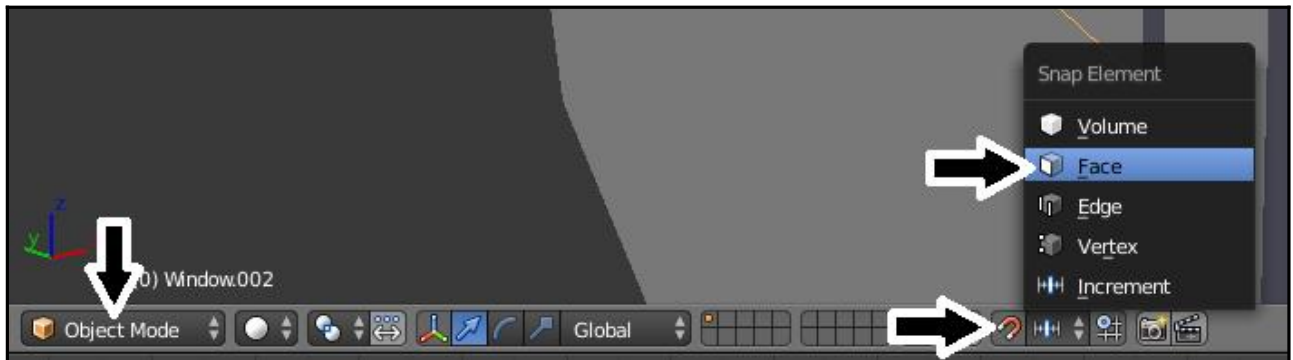
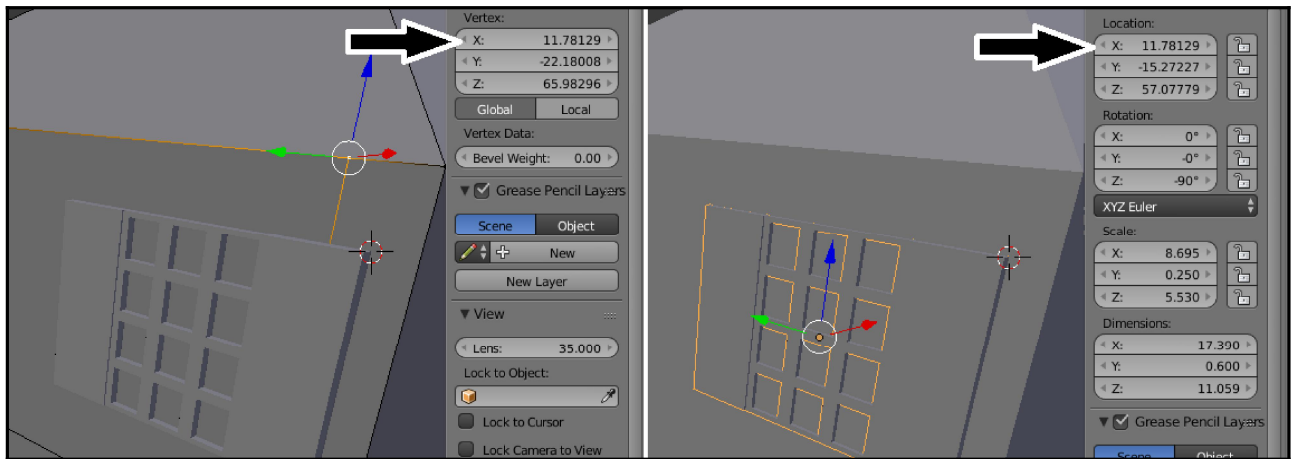
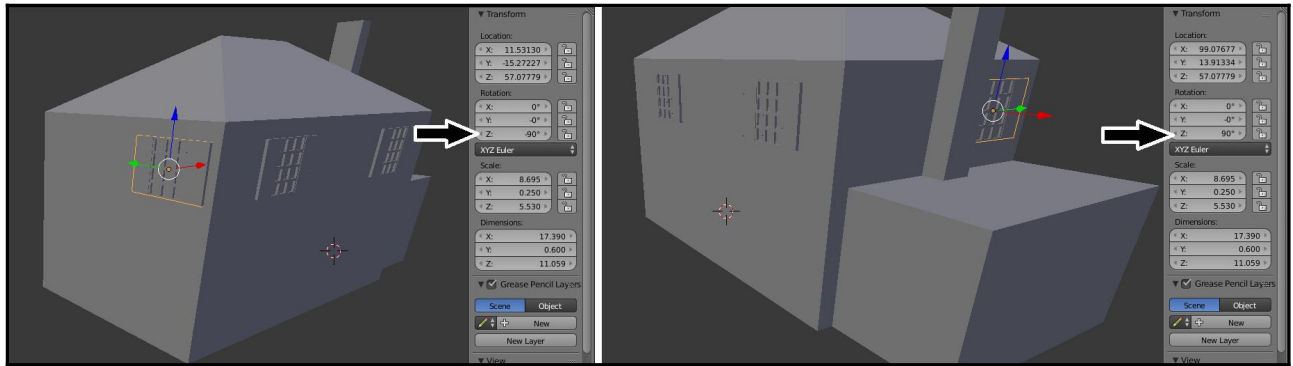

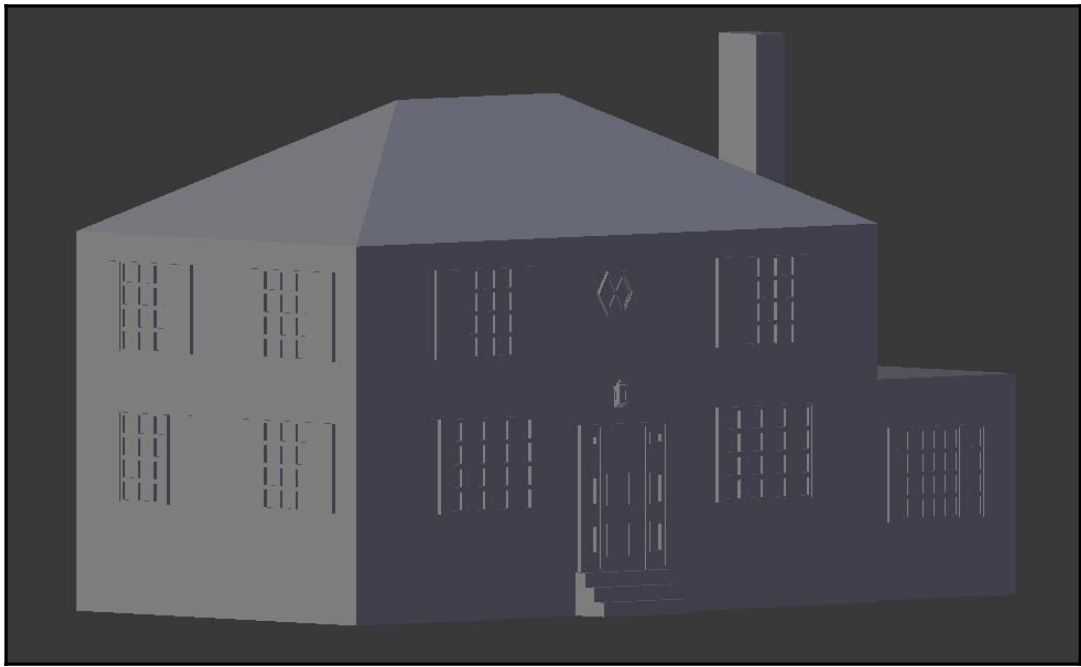
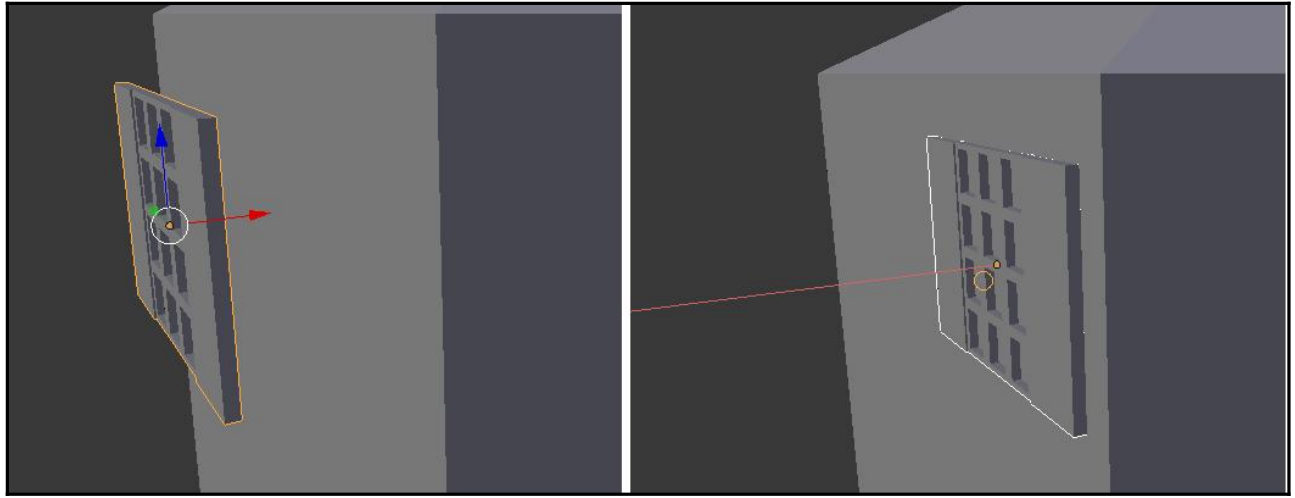

# Chapter 10: Making Textures with the Array Modifier and Scalable Vector Graphics

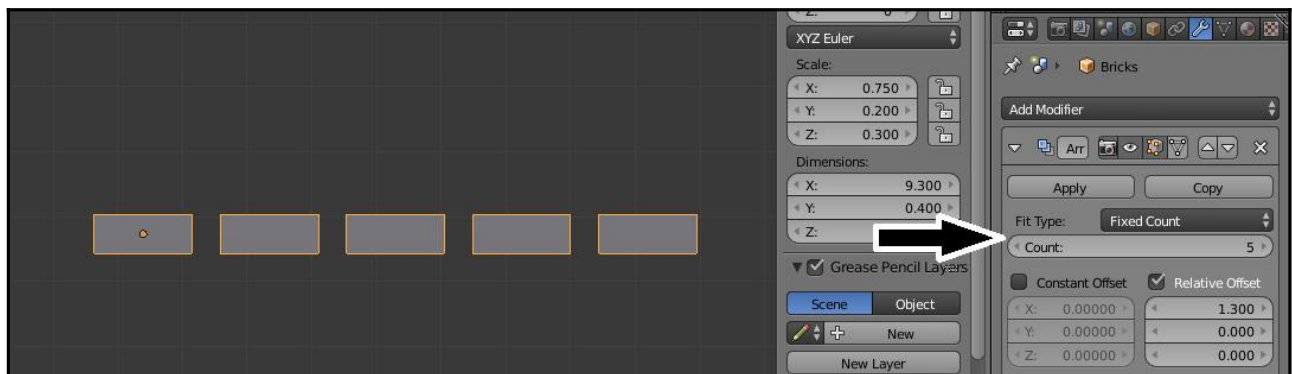
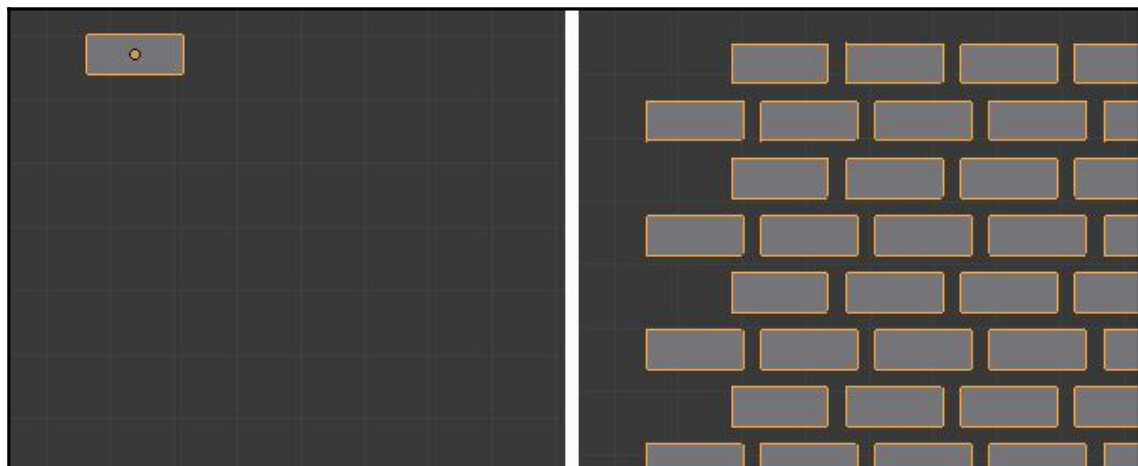
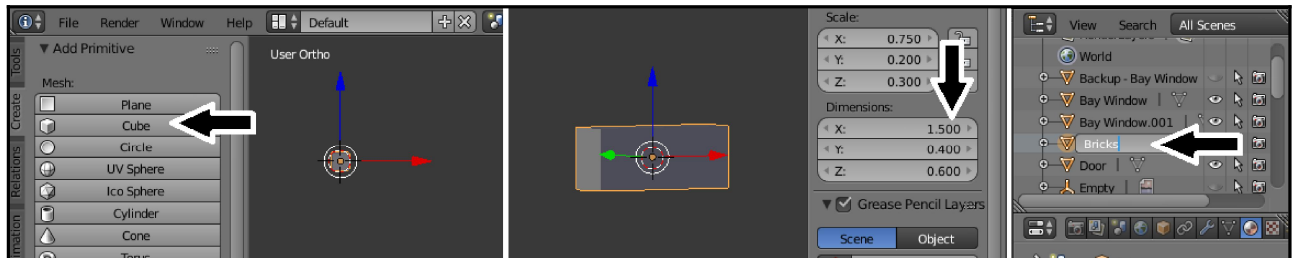

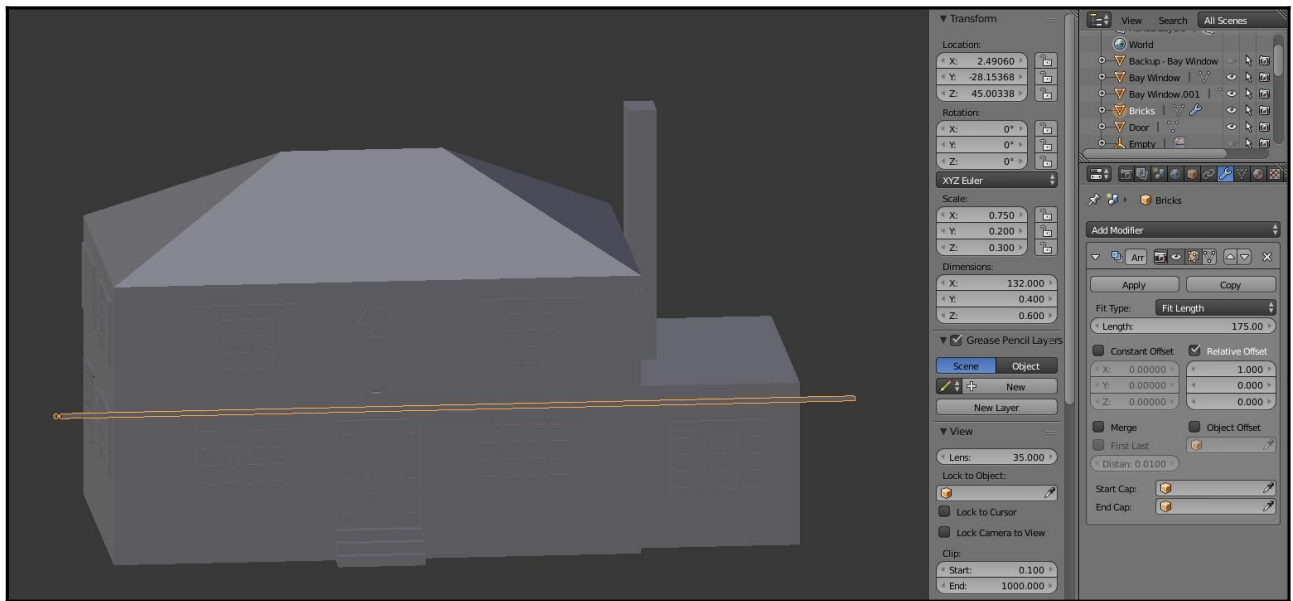
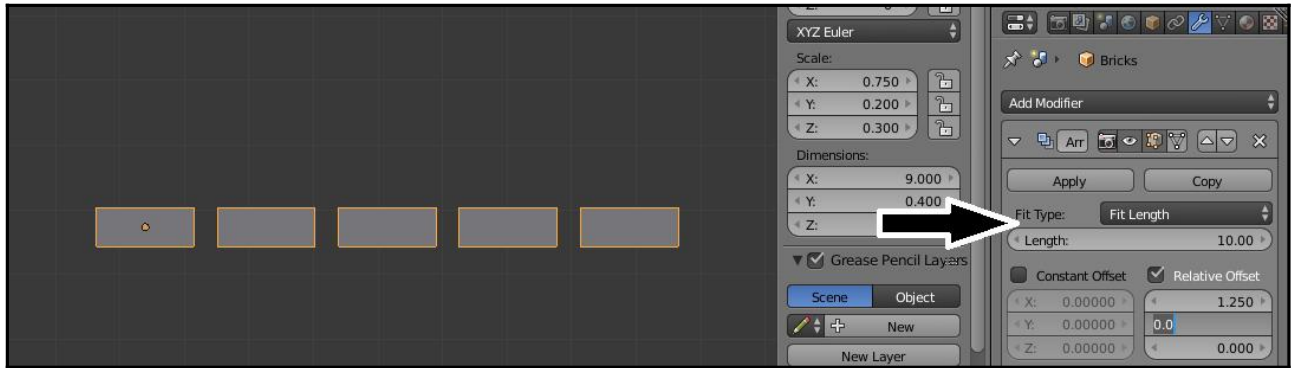

[Fit Length] x [Scale] = True Fit Length  
100 x 0.75 = 75

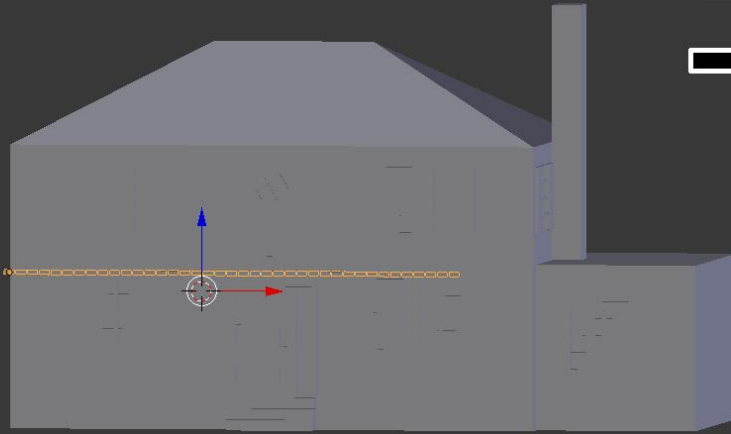

A screenshot of the Blender 2.80 software interface. The left sidebar shows the 'Properties' panel for the 'Scene' object, with the 'Scene' tab selected. The 'Scale' section shows X: 0.750, Y: 0.200, and Z: 0.300. The 'Dimensions' section shows X: 75.600, Y: 0.400, and Z: 0.600. The 'View' section shows 'Lens: 35.000'. The right sidebar shows the 'Modifiers' panel with the 'Fit Length' modifier selected. The 'Fit Length' modifier has a 'Length' of 100.00. The 'Relative Offsets' section shows X: 1.300, Y: 0.000, and Z: 0.000. The 'Start Cap' and 'End Cap' options are also visible.

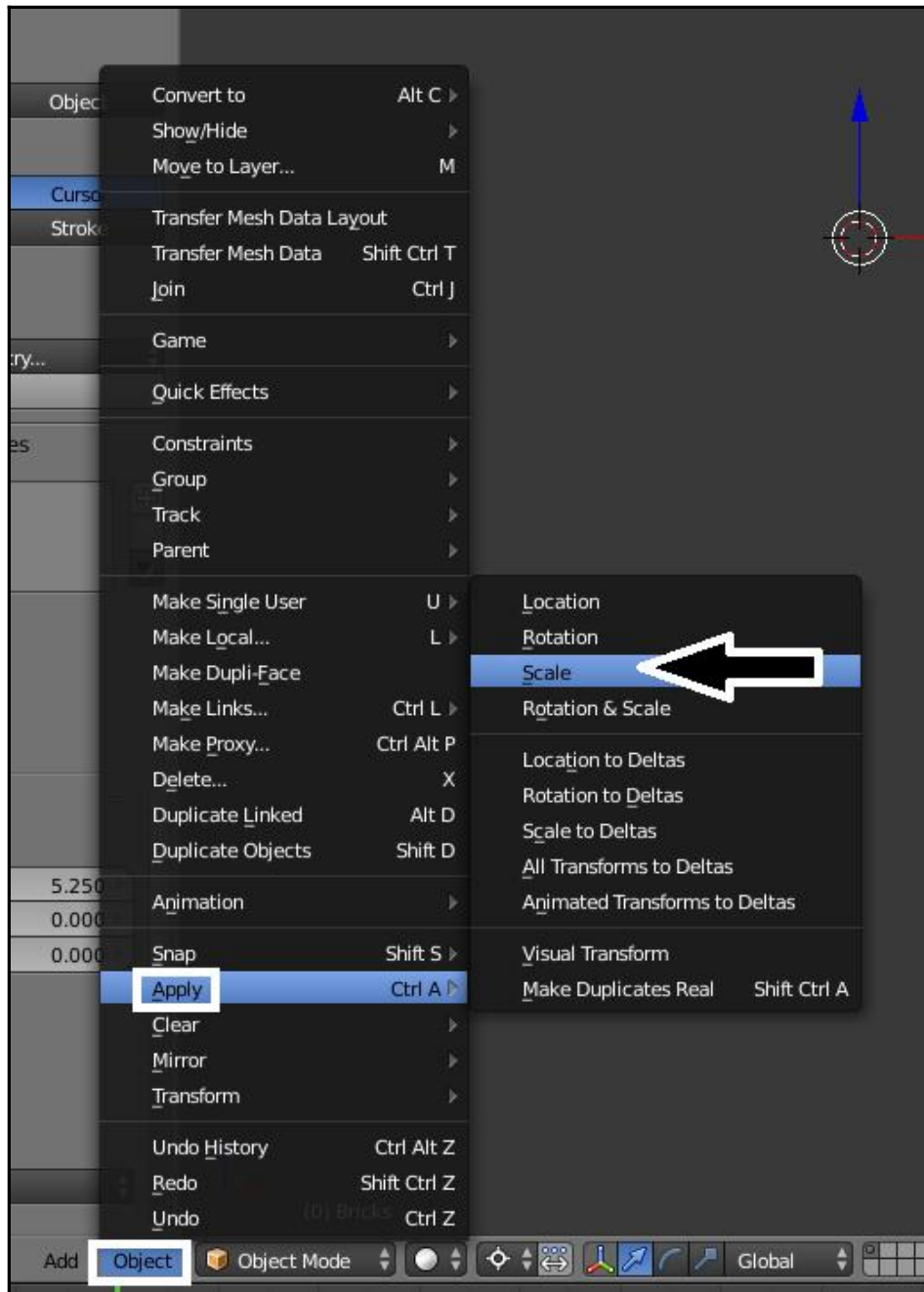

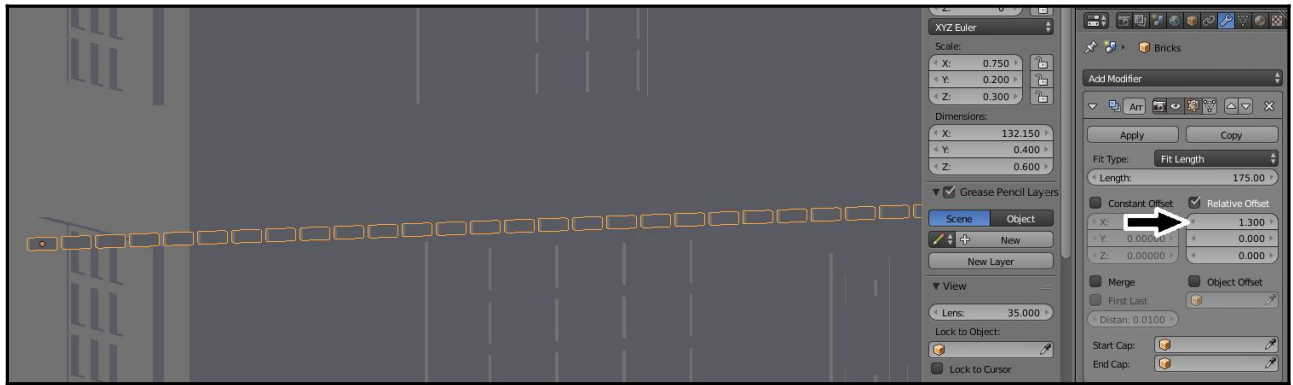
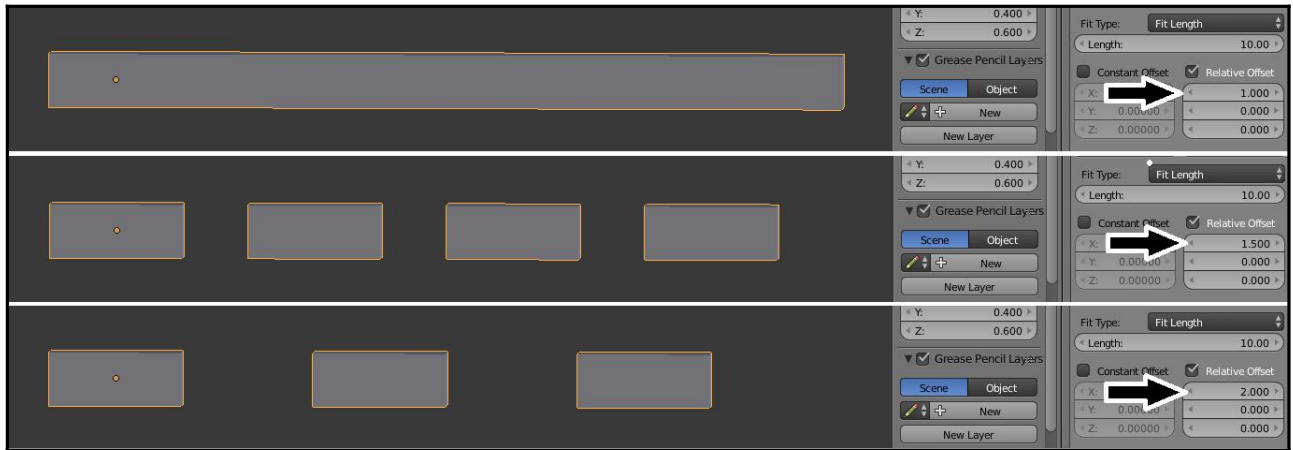
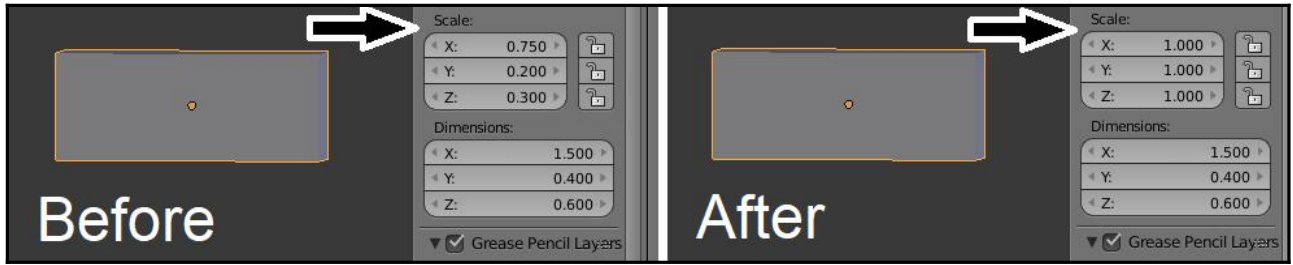

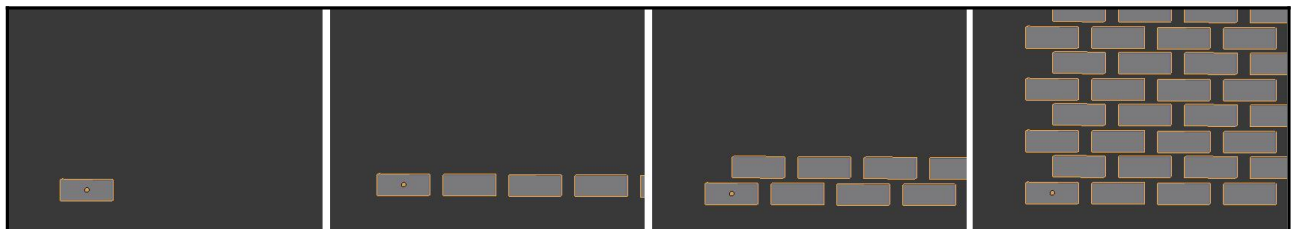
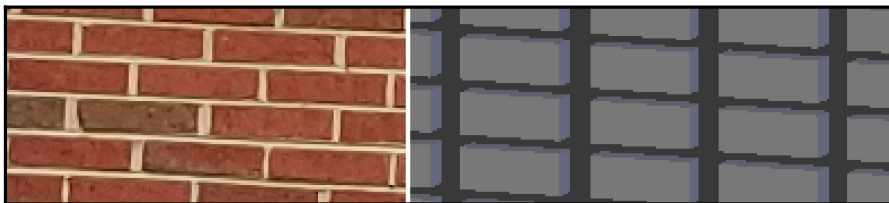
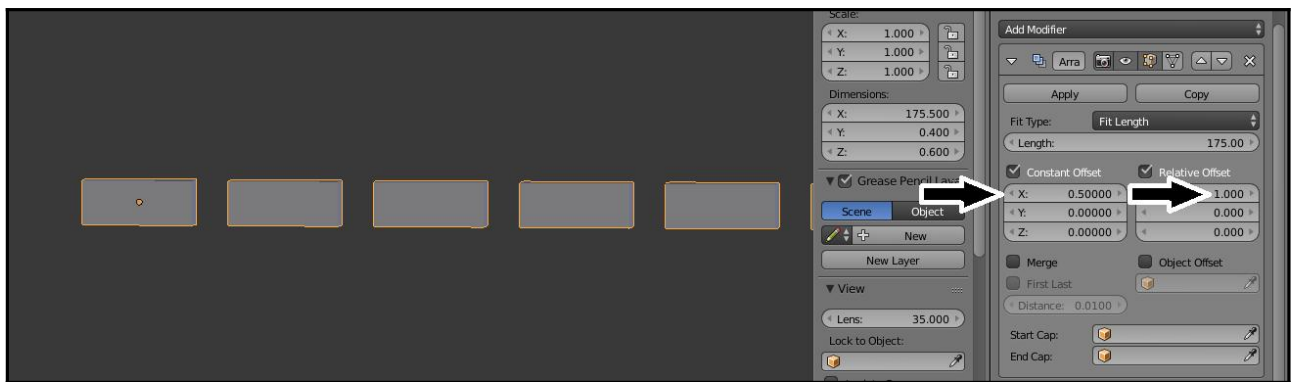



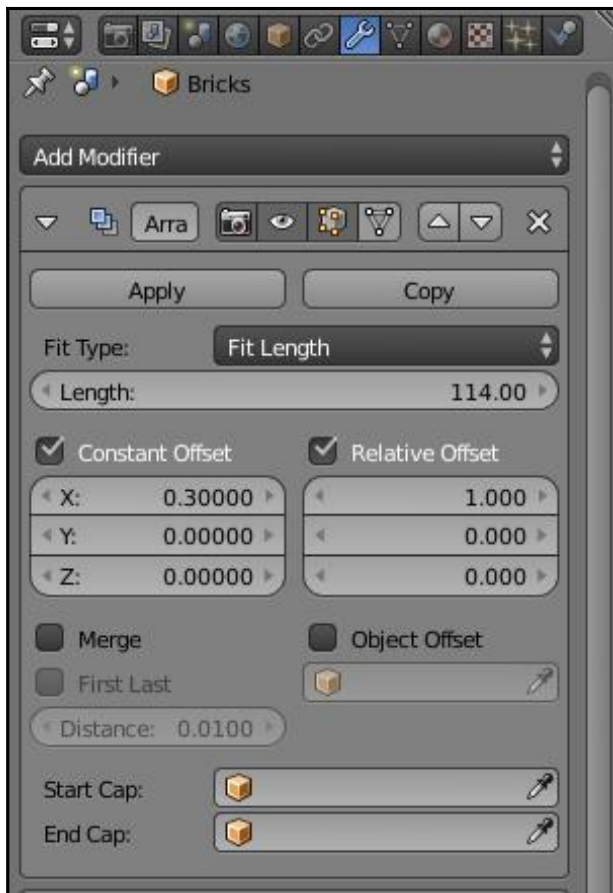
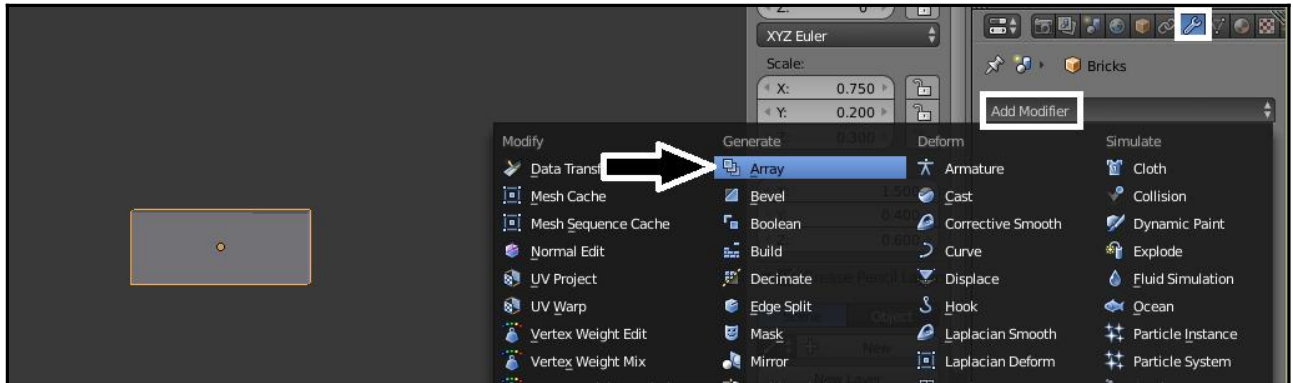

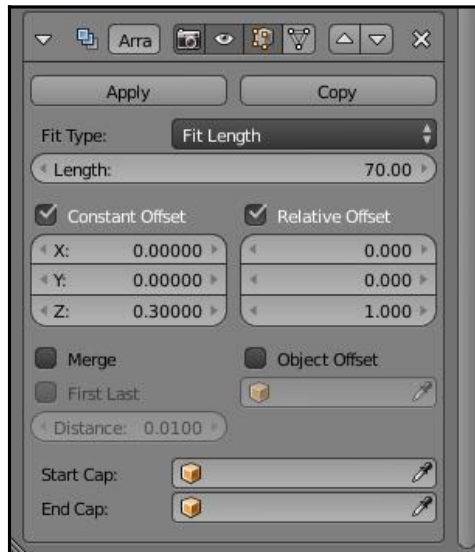
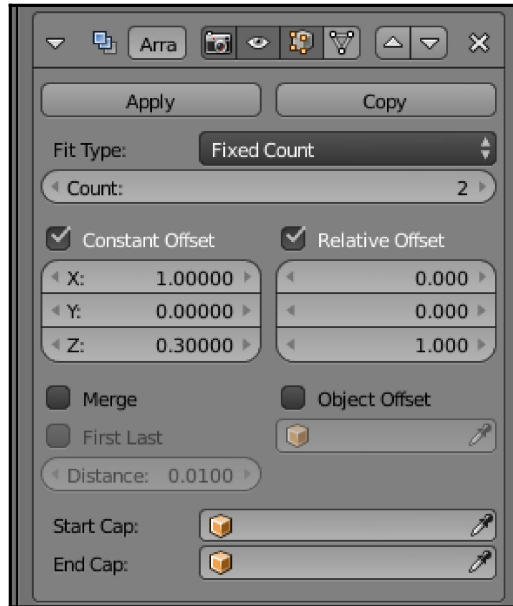

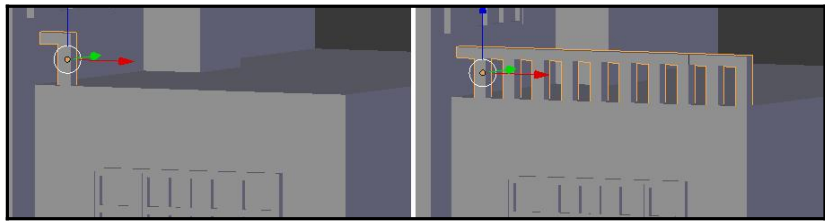
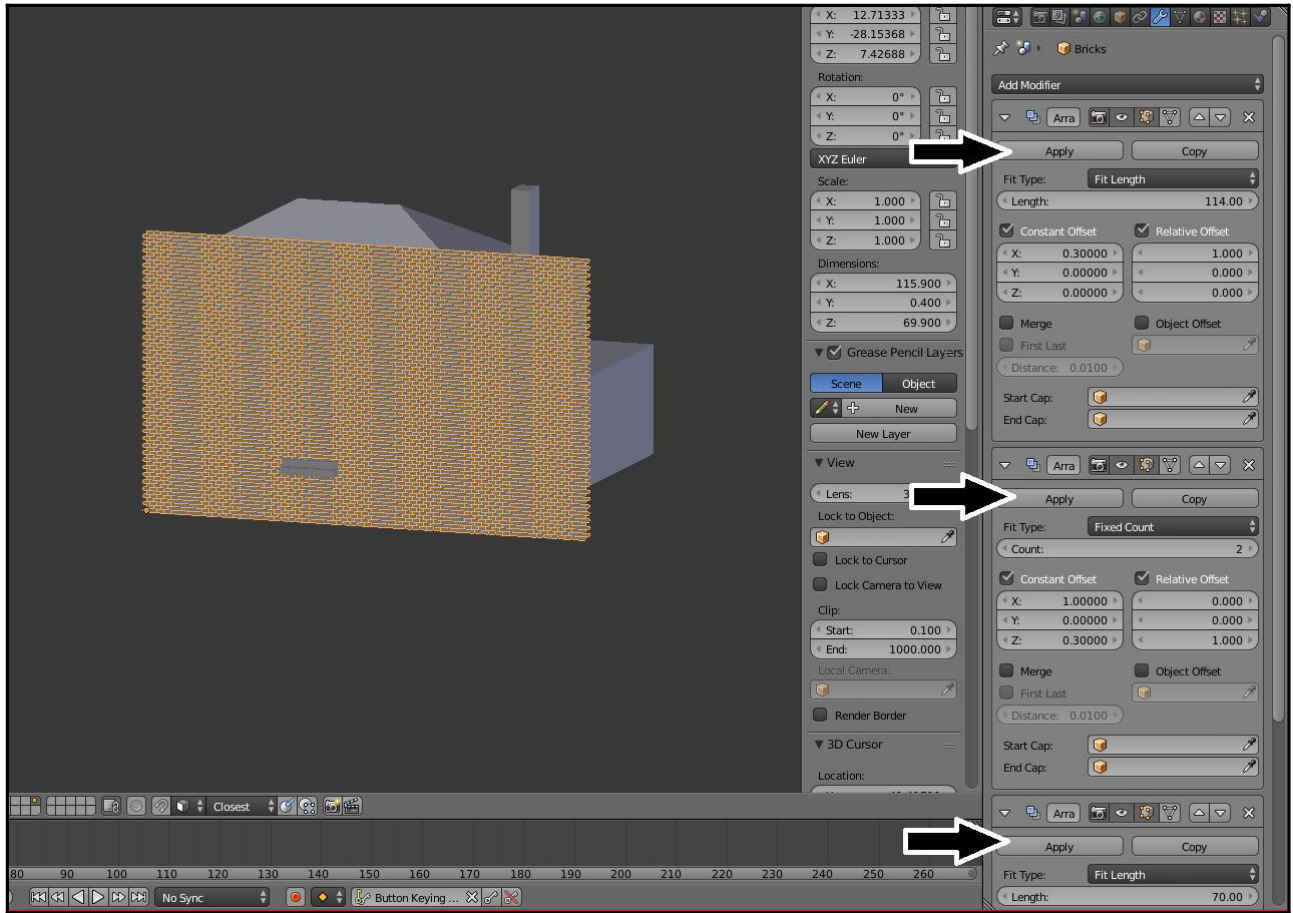



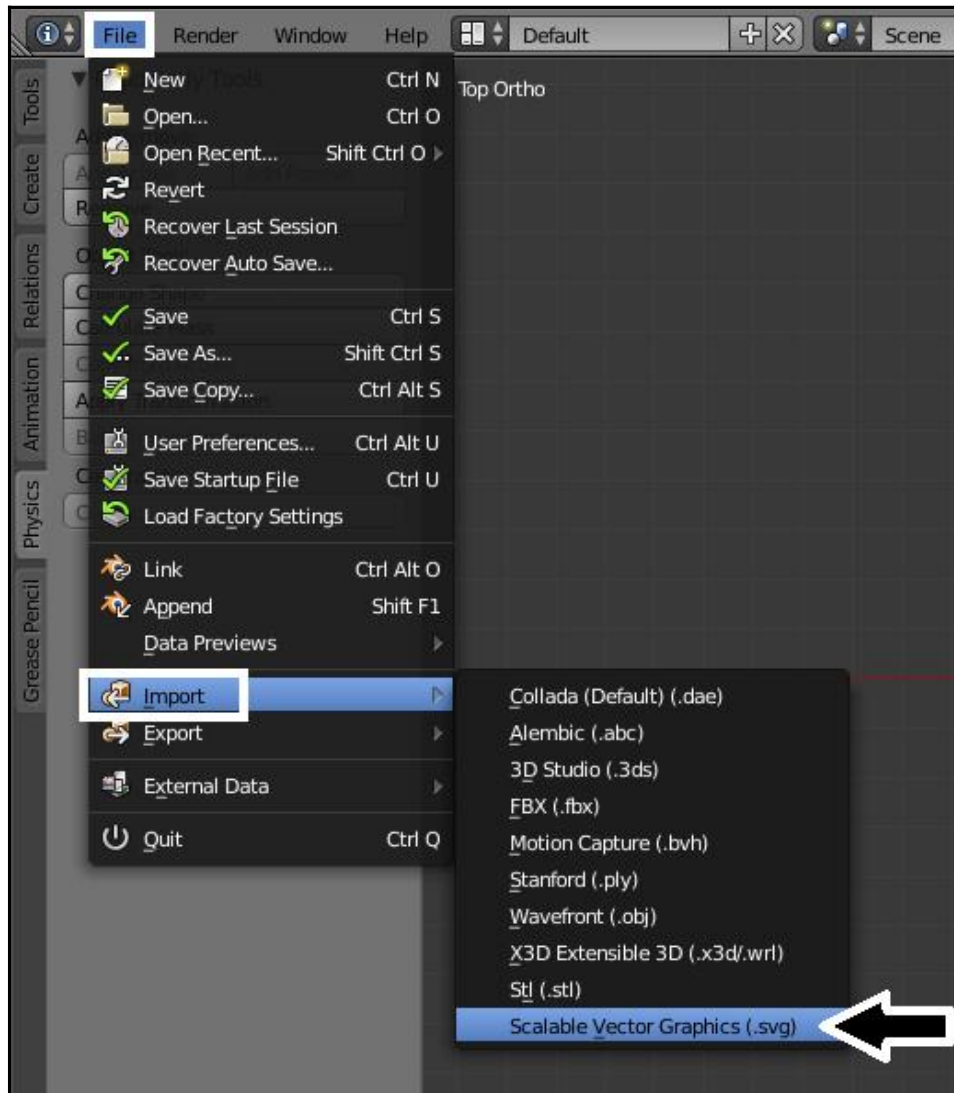

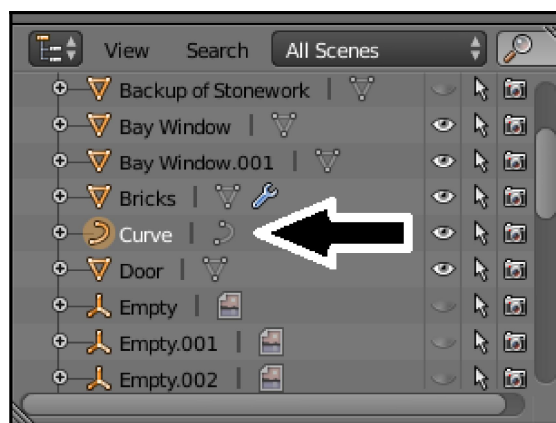
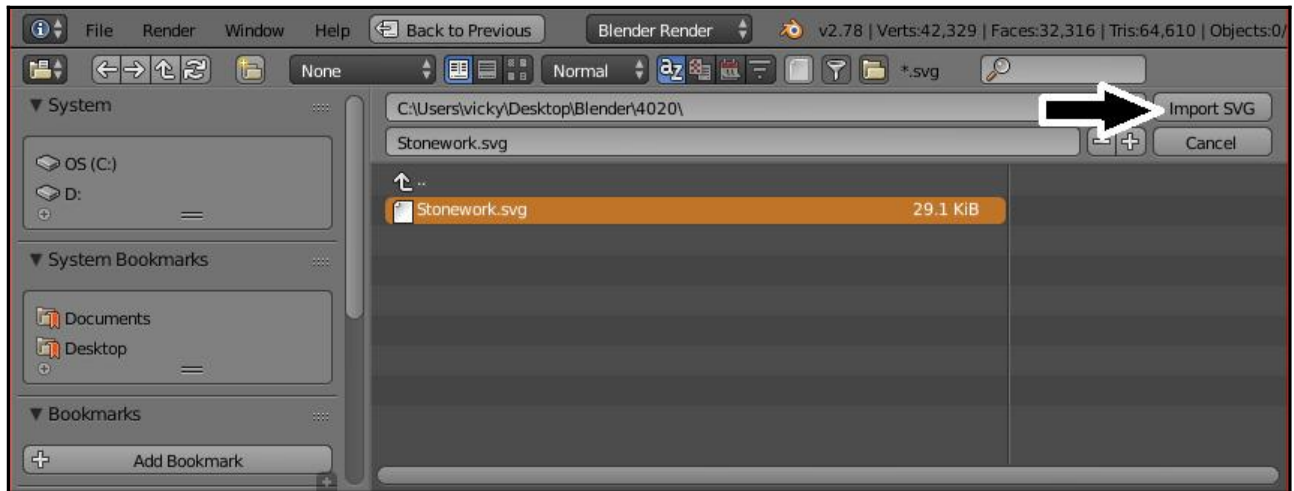

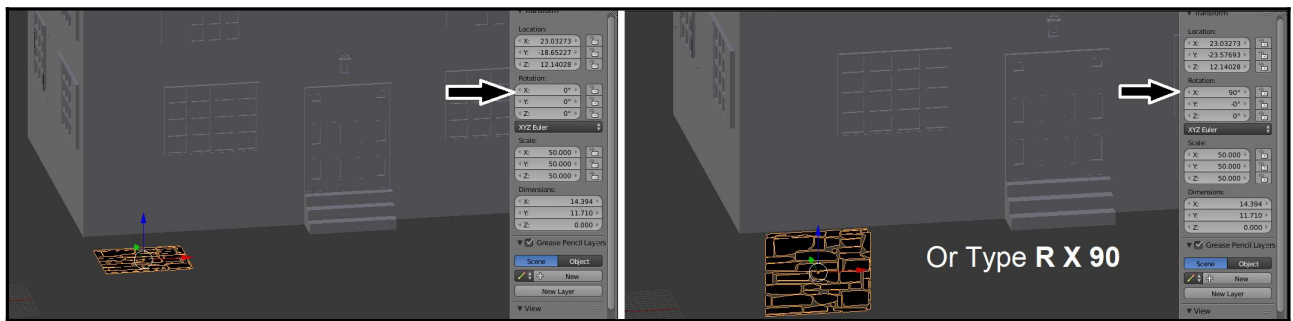
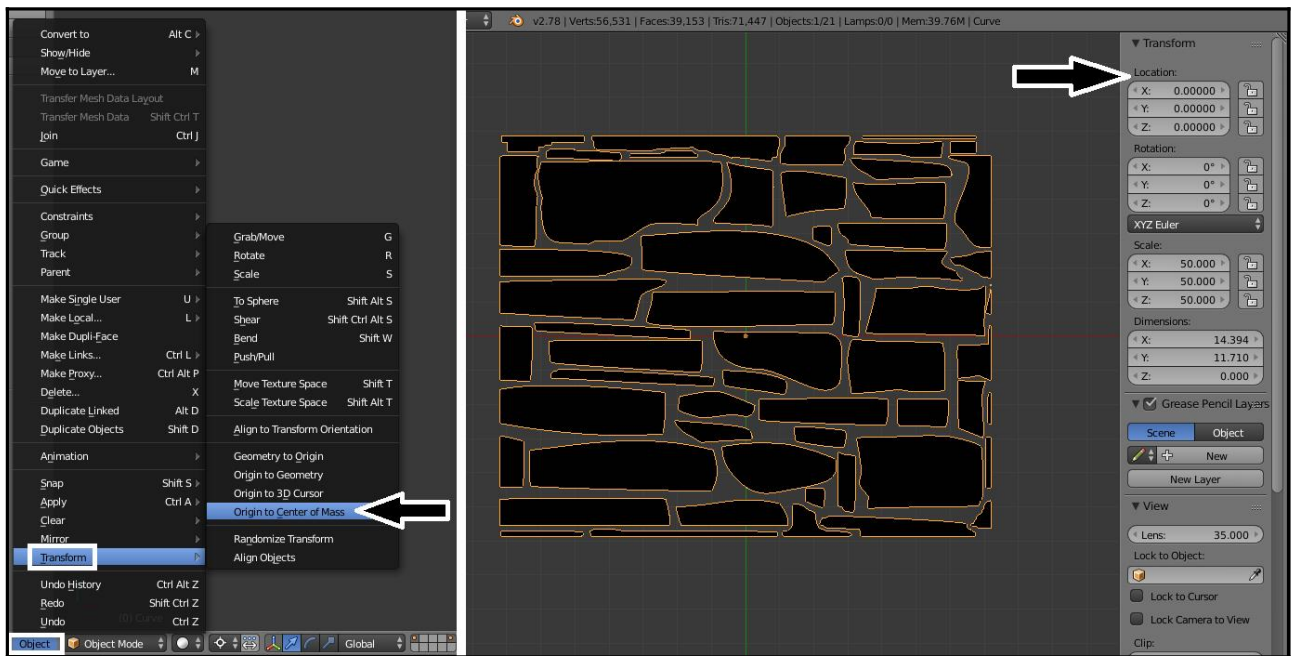
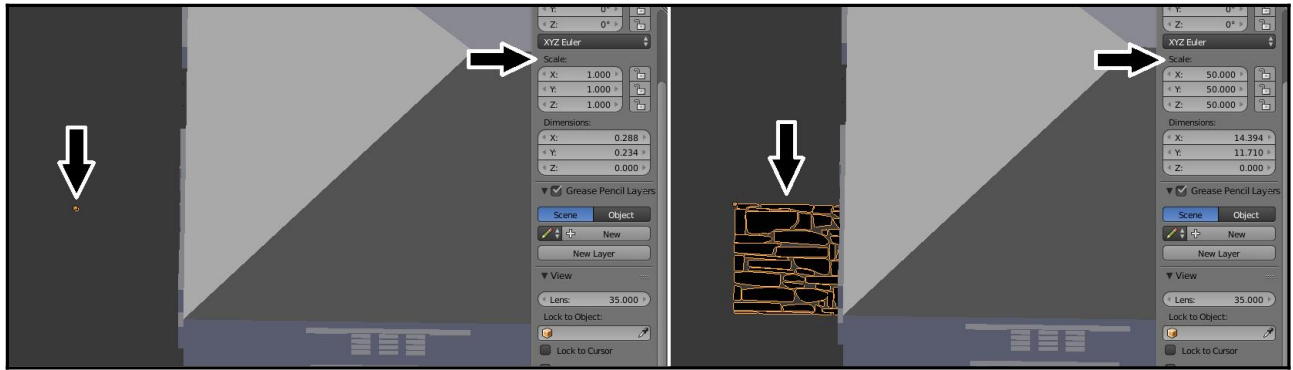

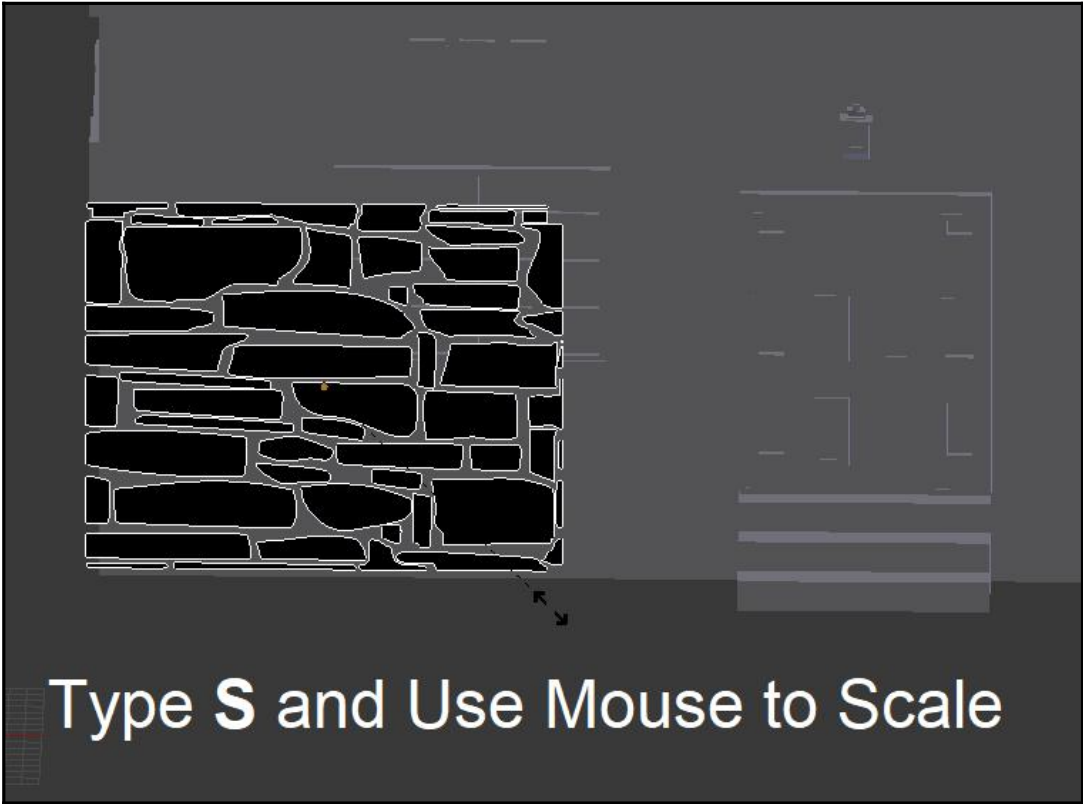



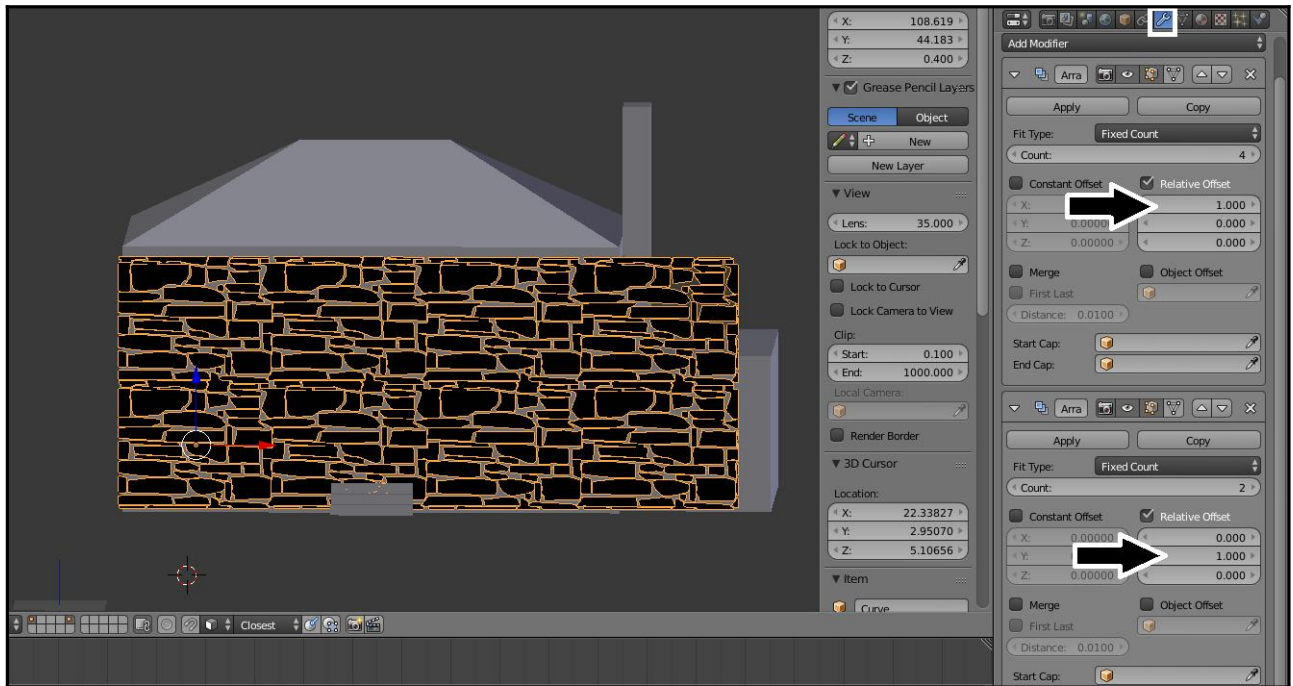
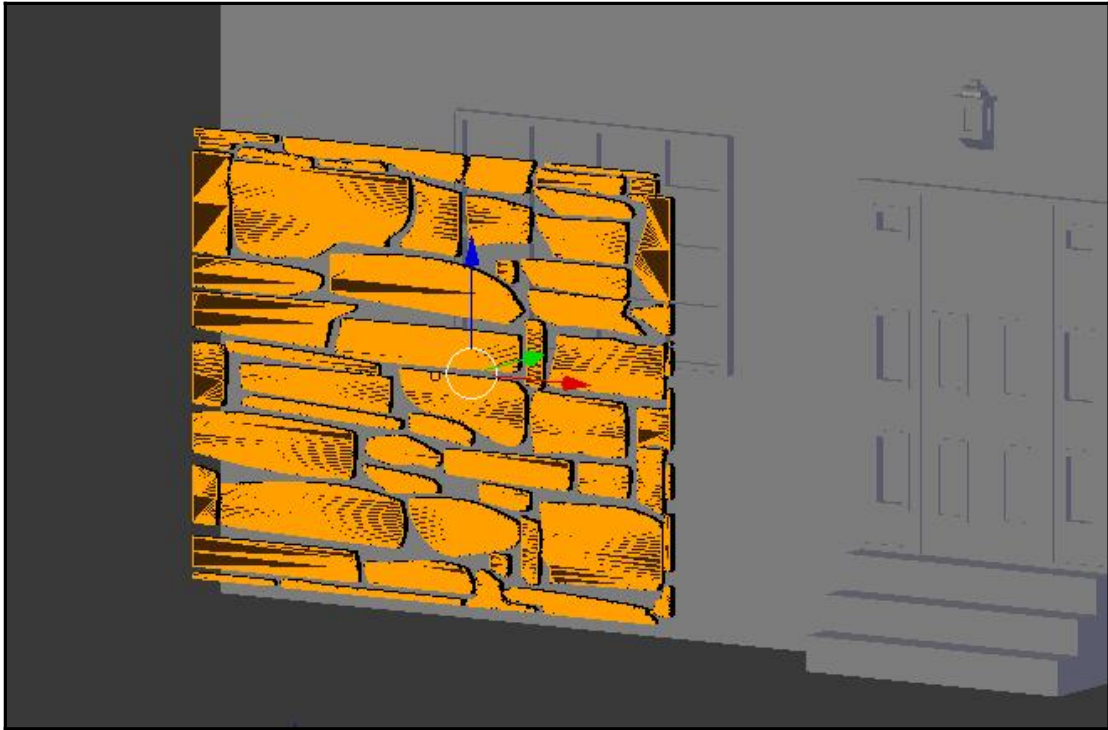

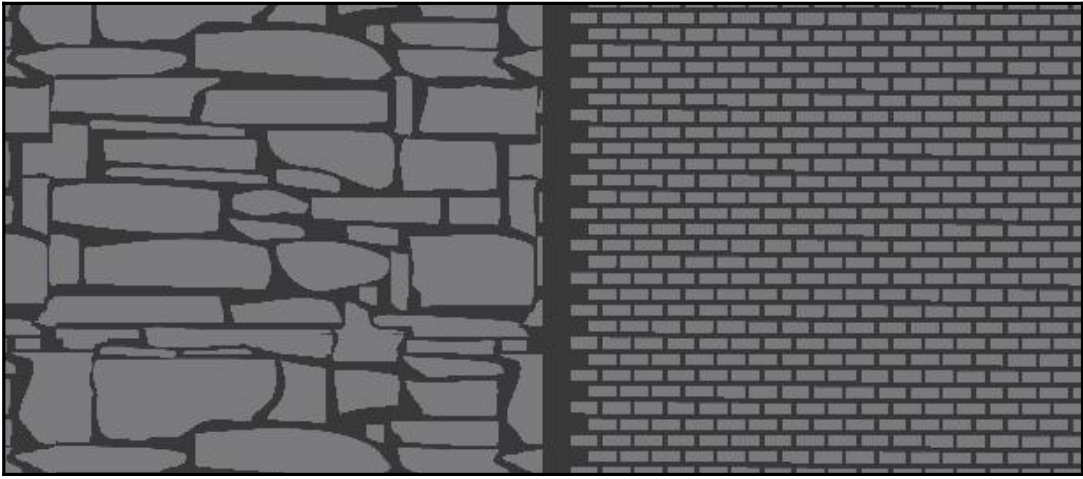

# Chapter 11: Applying Textures with Boolean Intersection

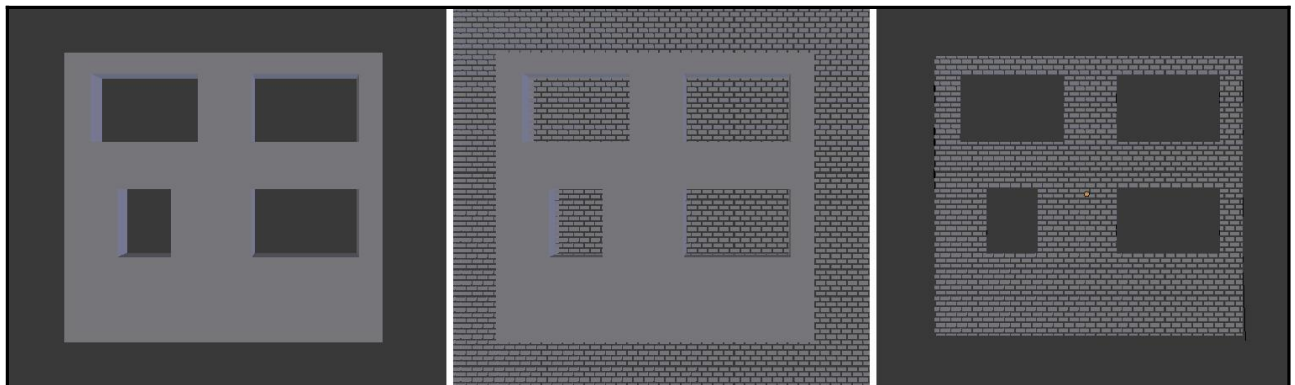
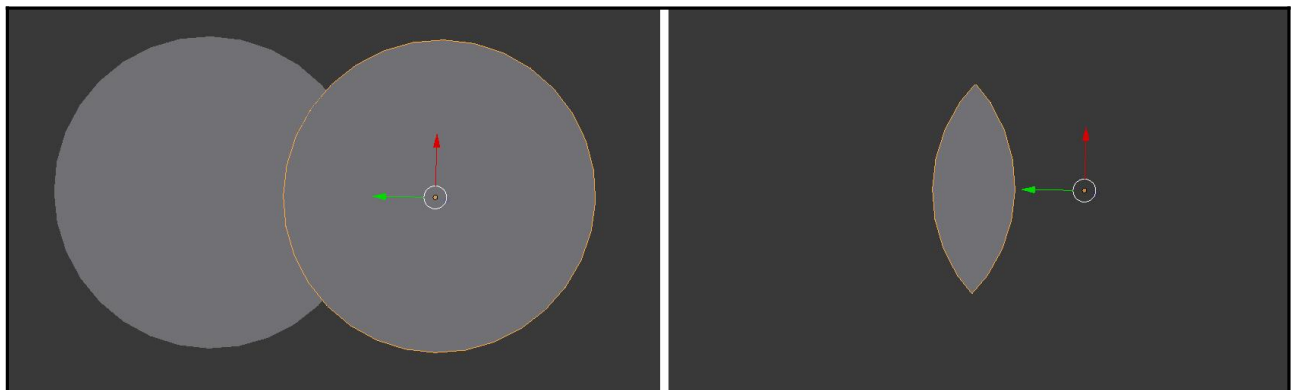
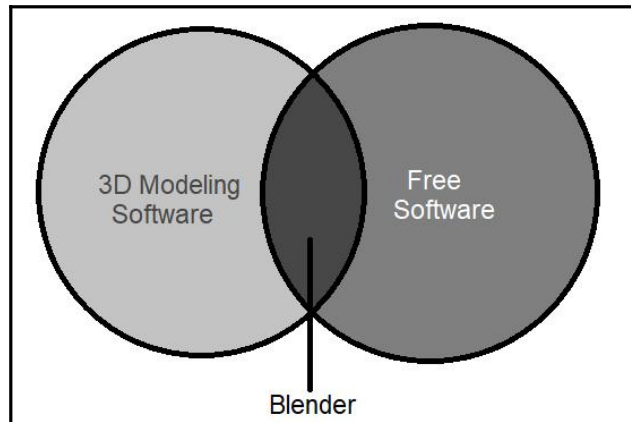

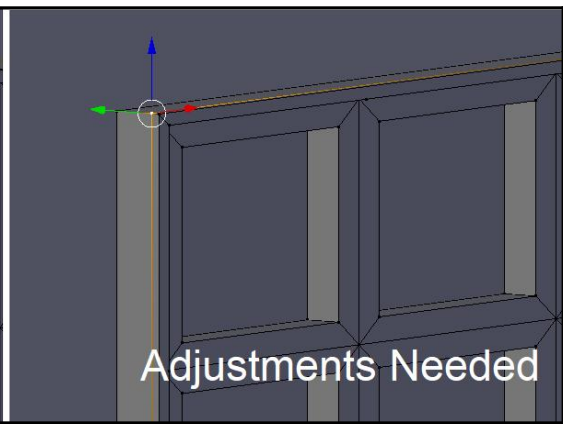
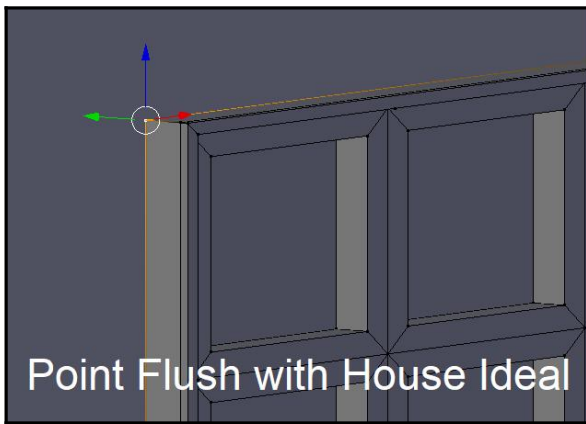
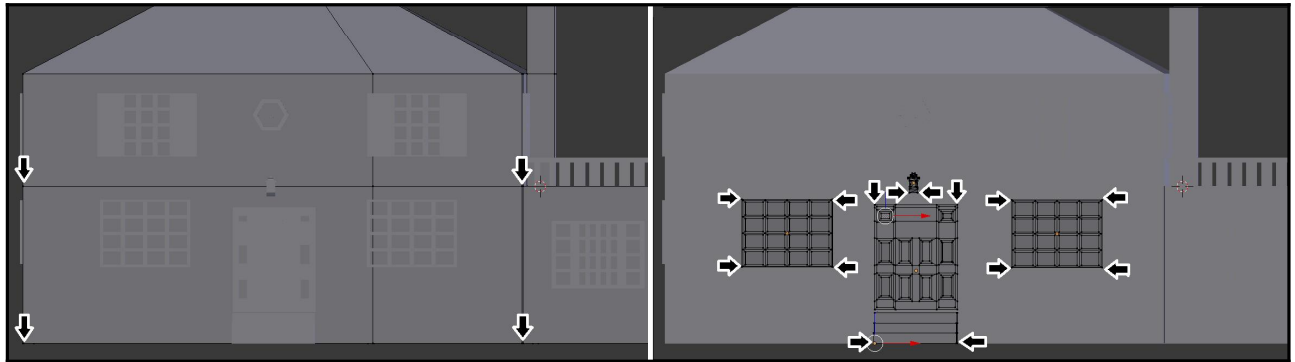
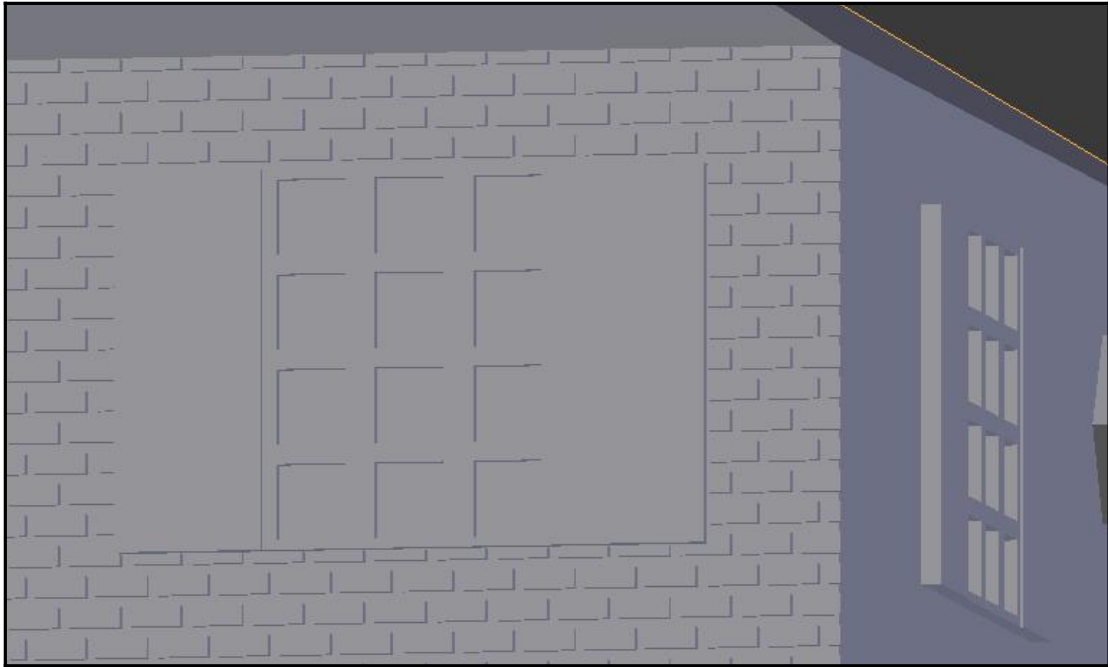

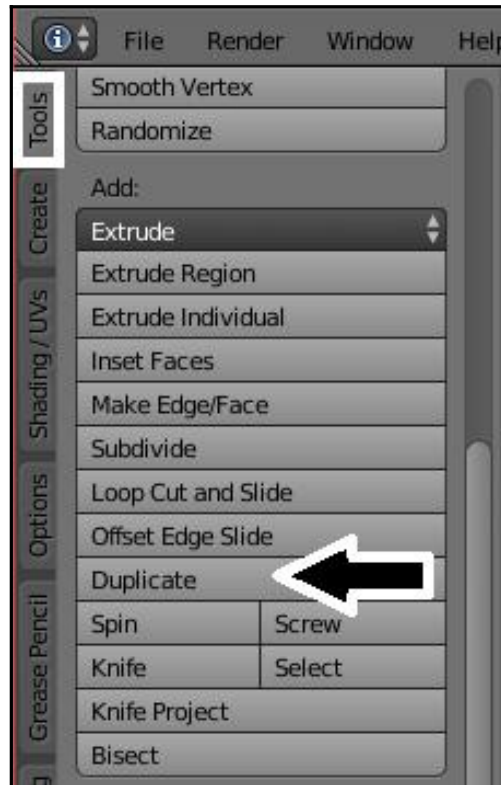
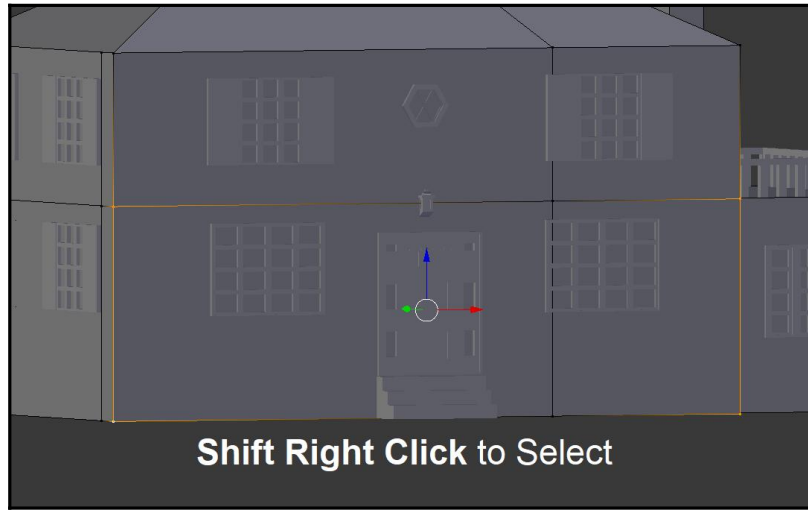

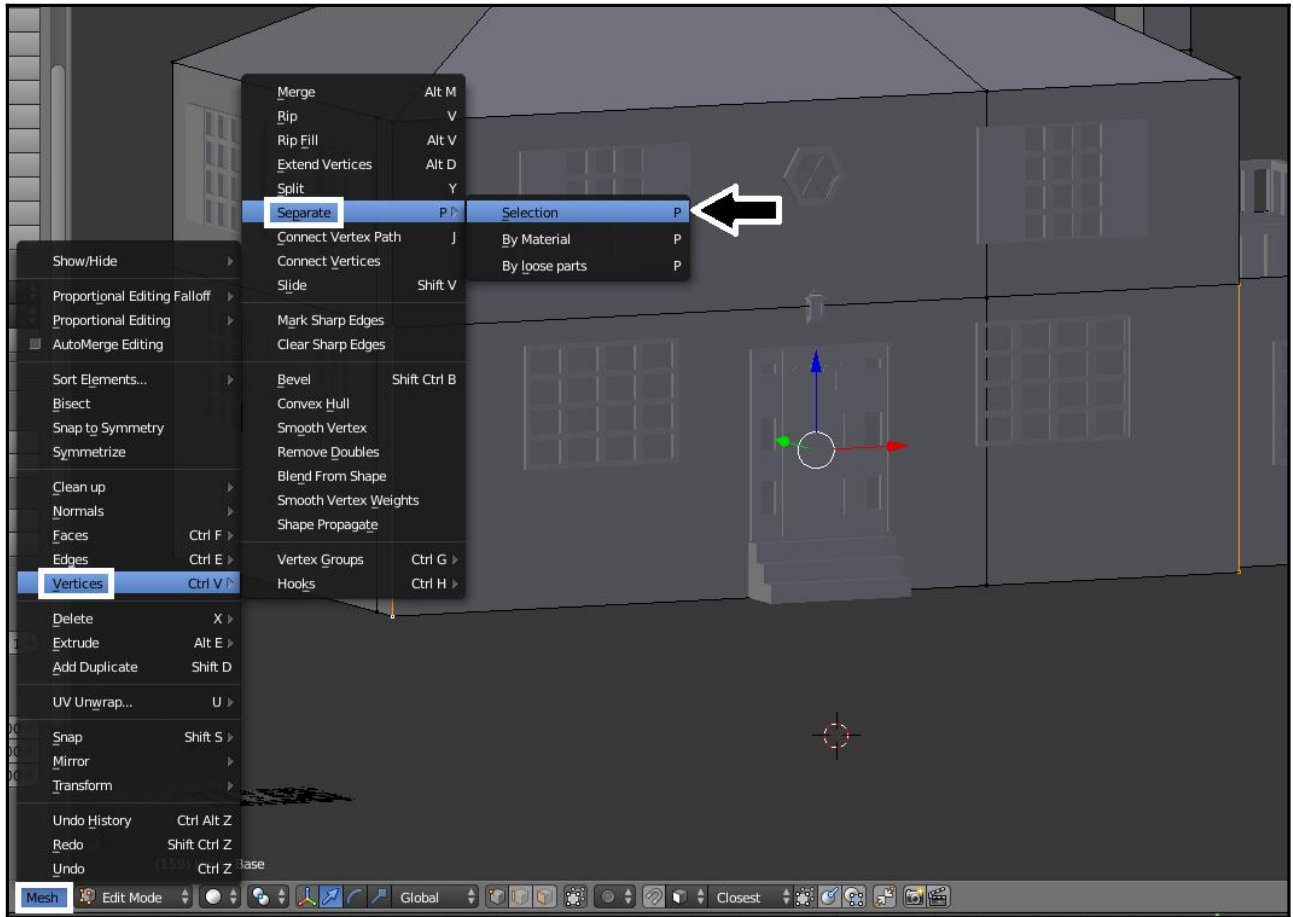

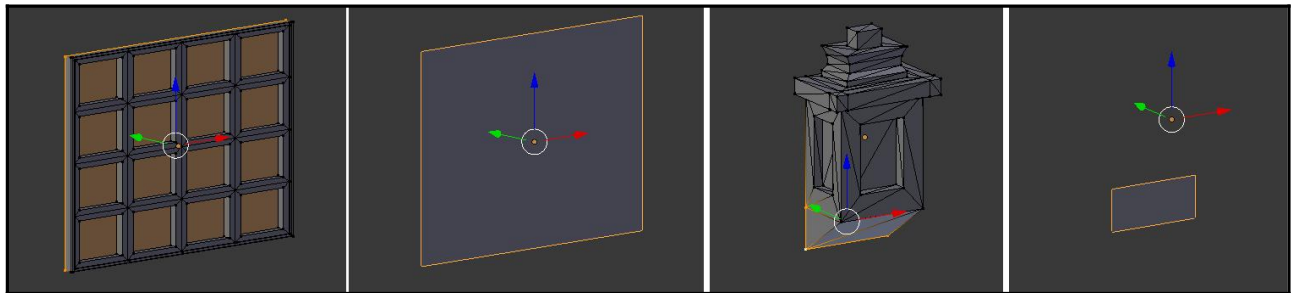
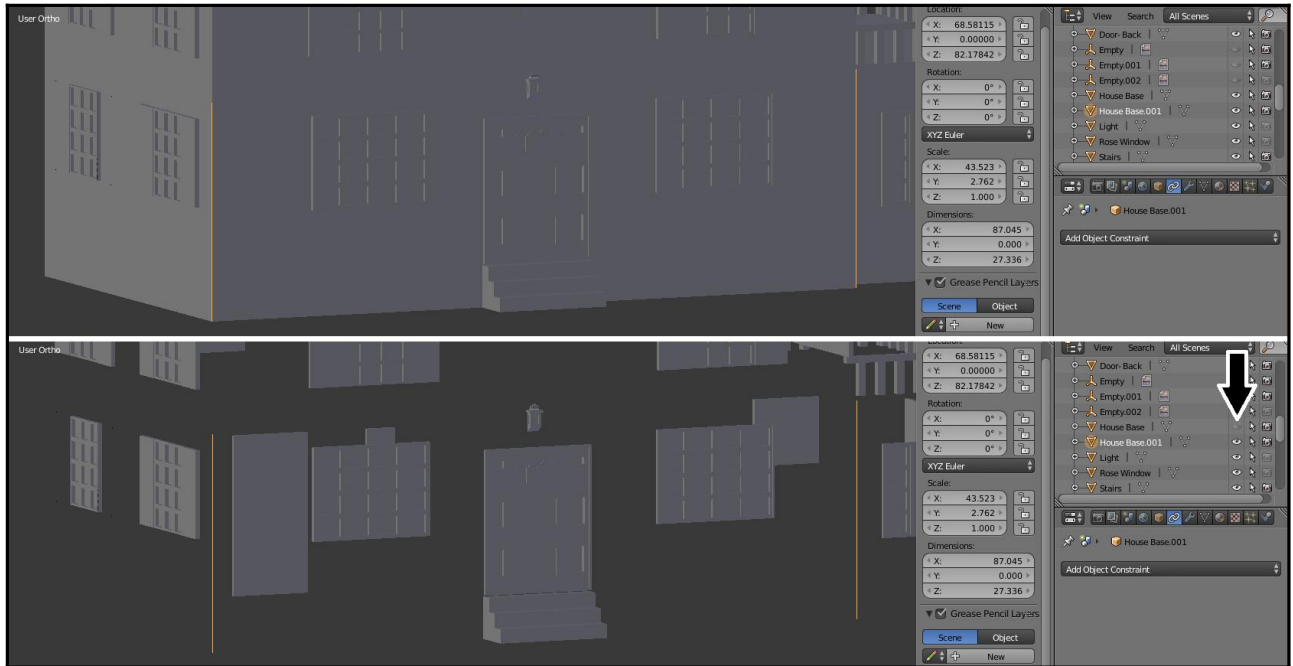

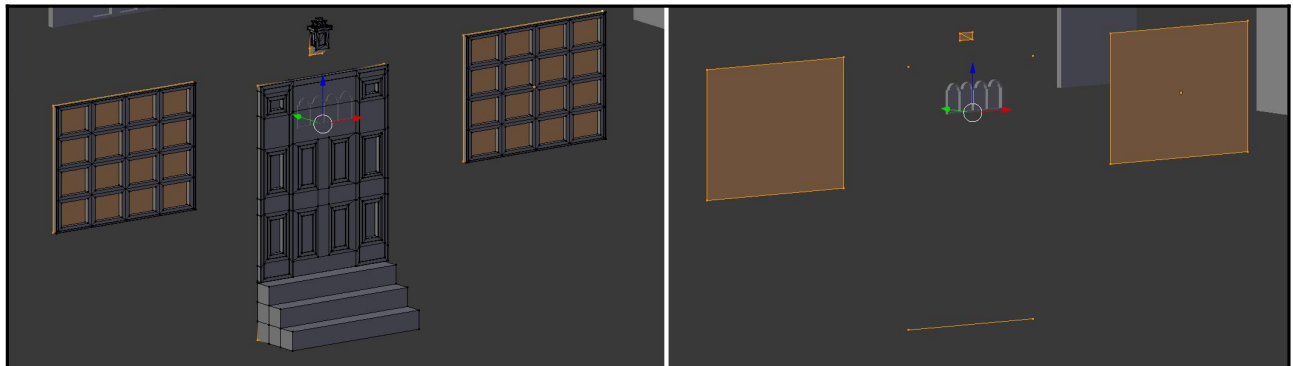
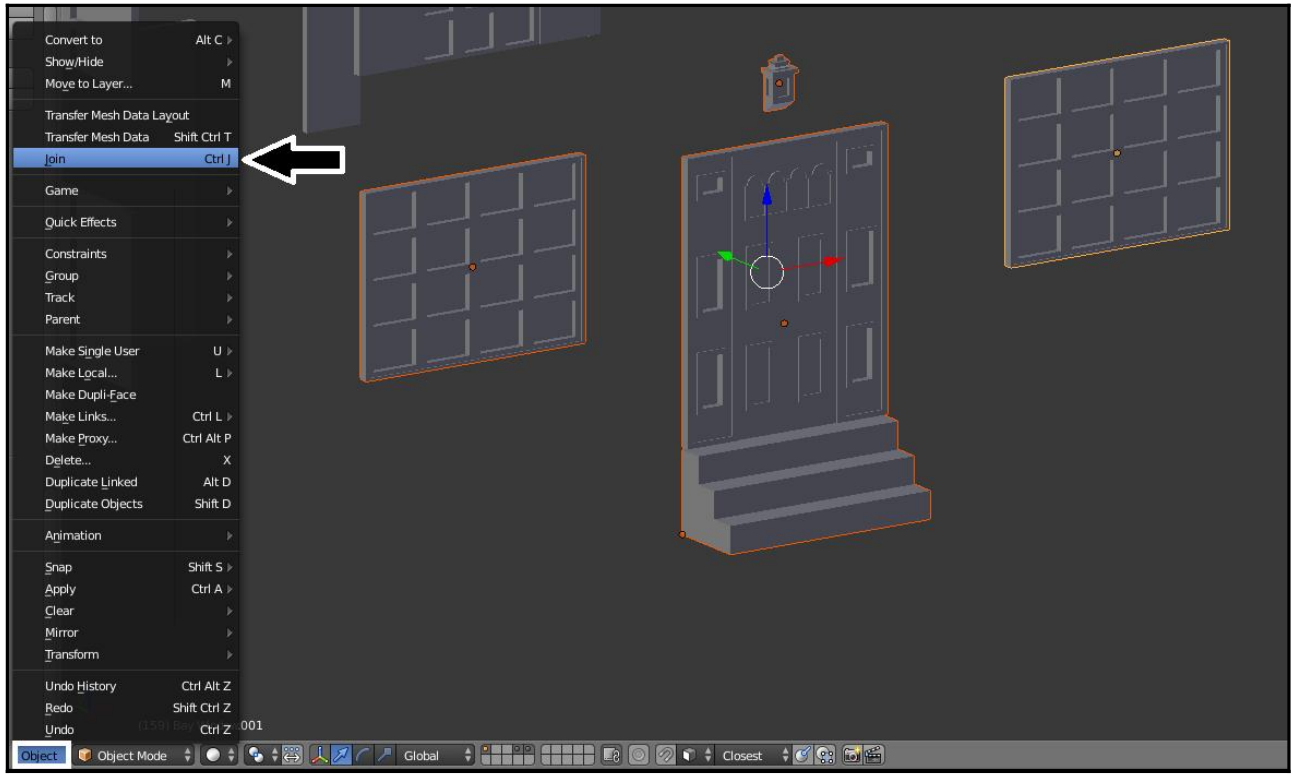



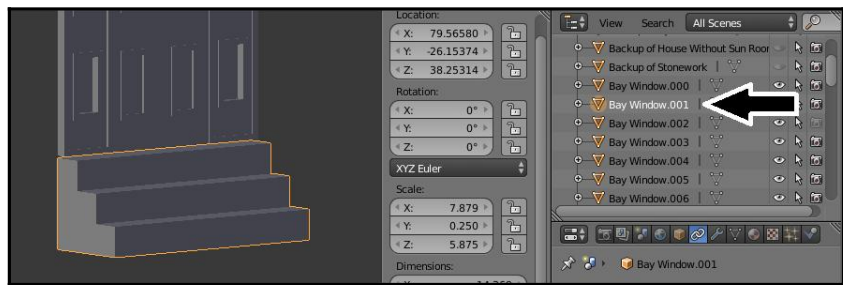
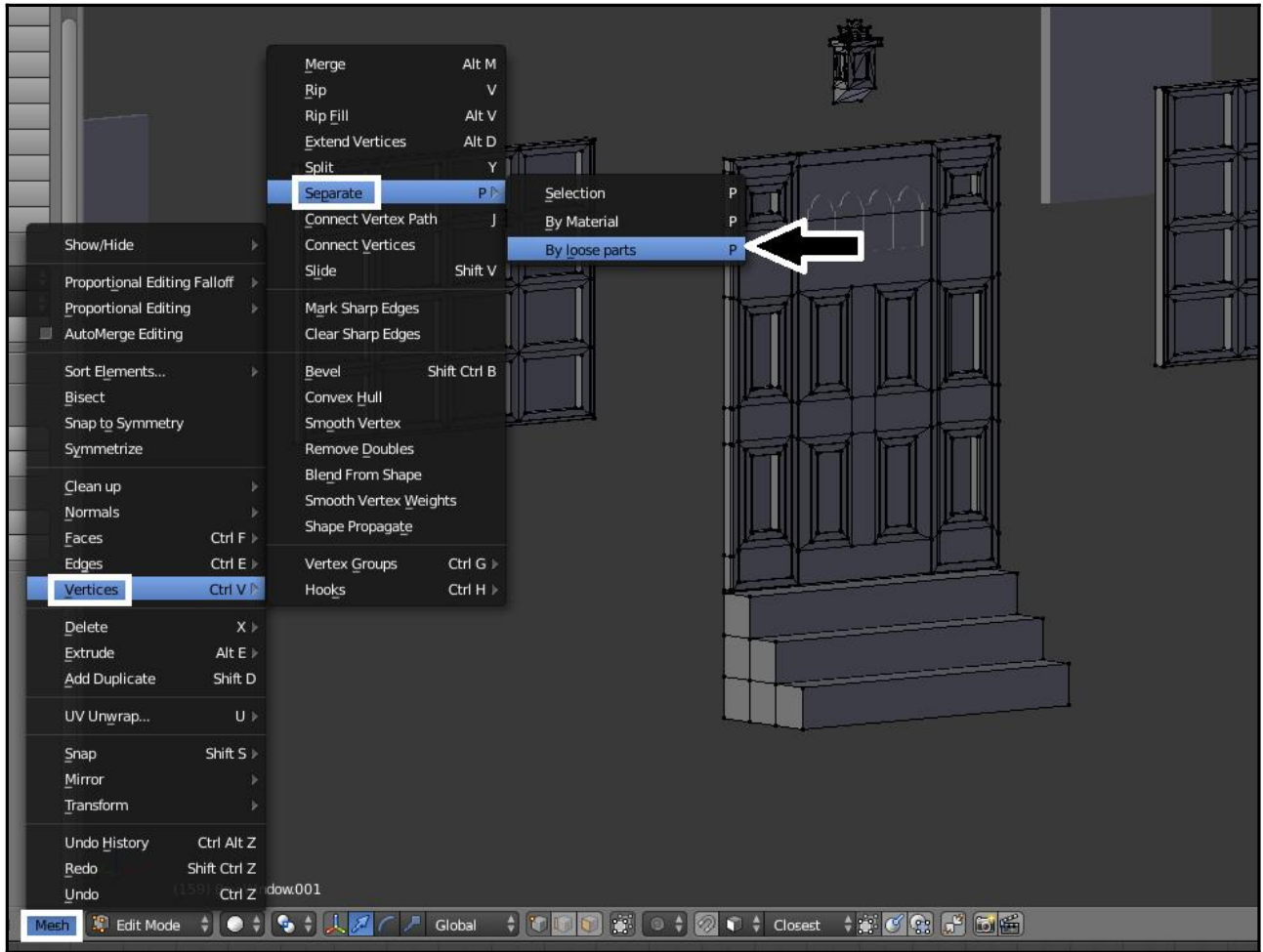

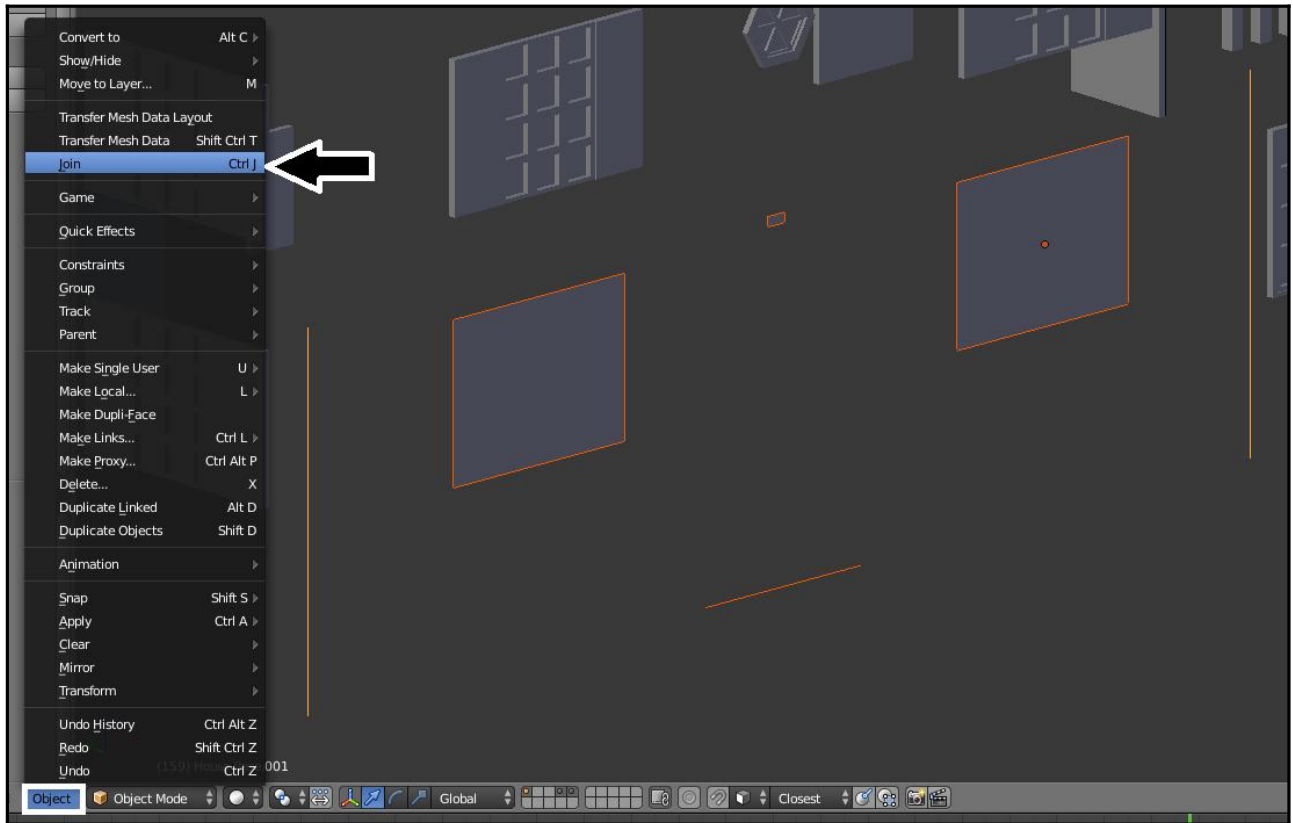
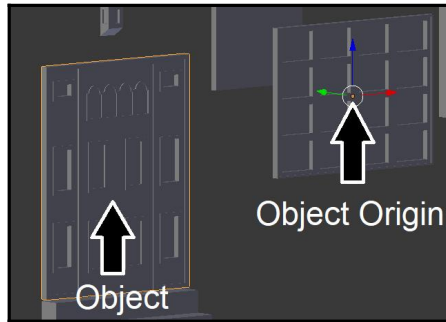

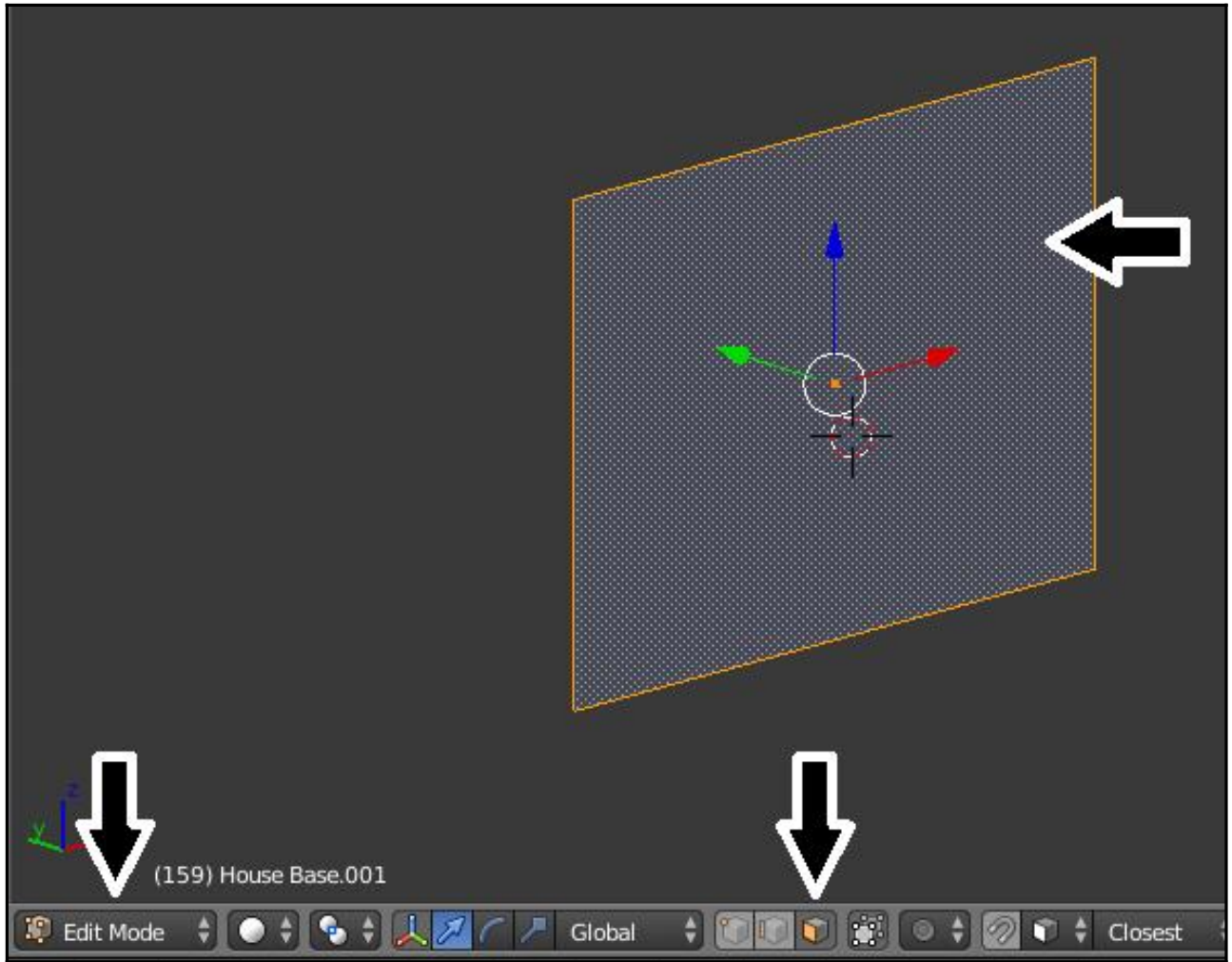

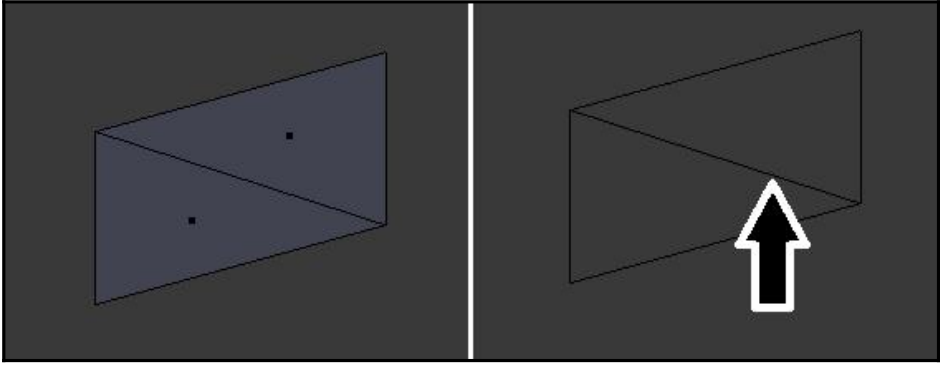
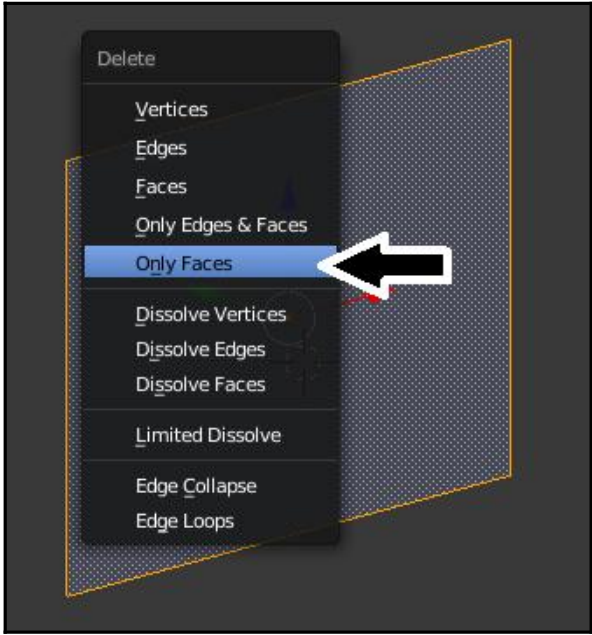

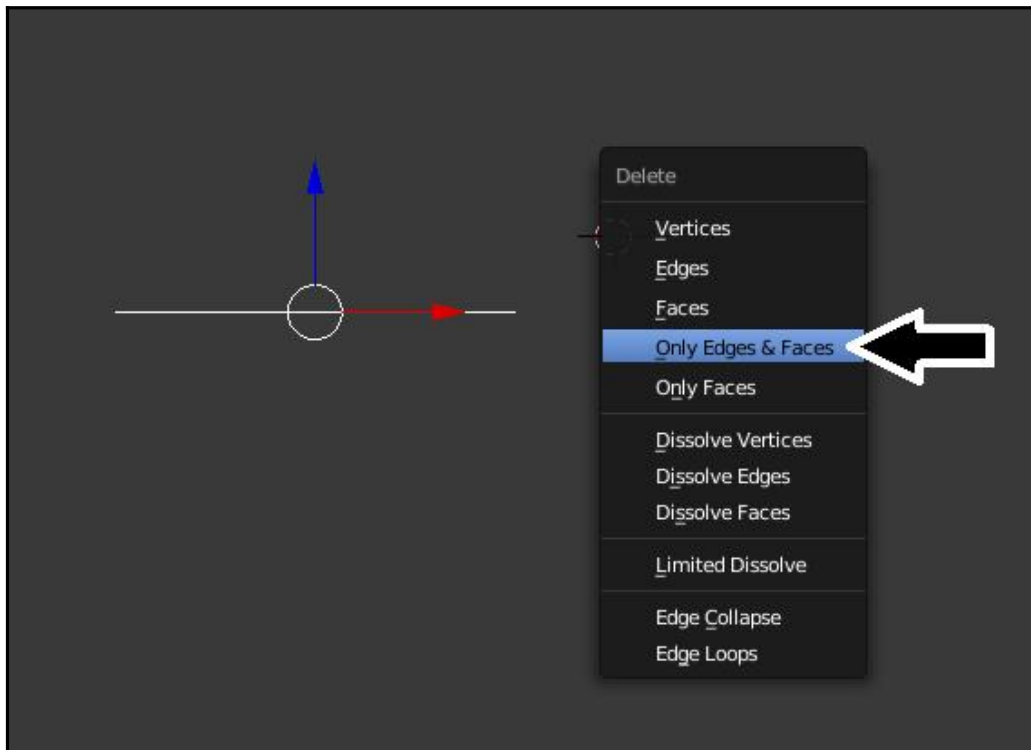
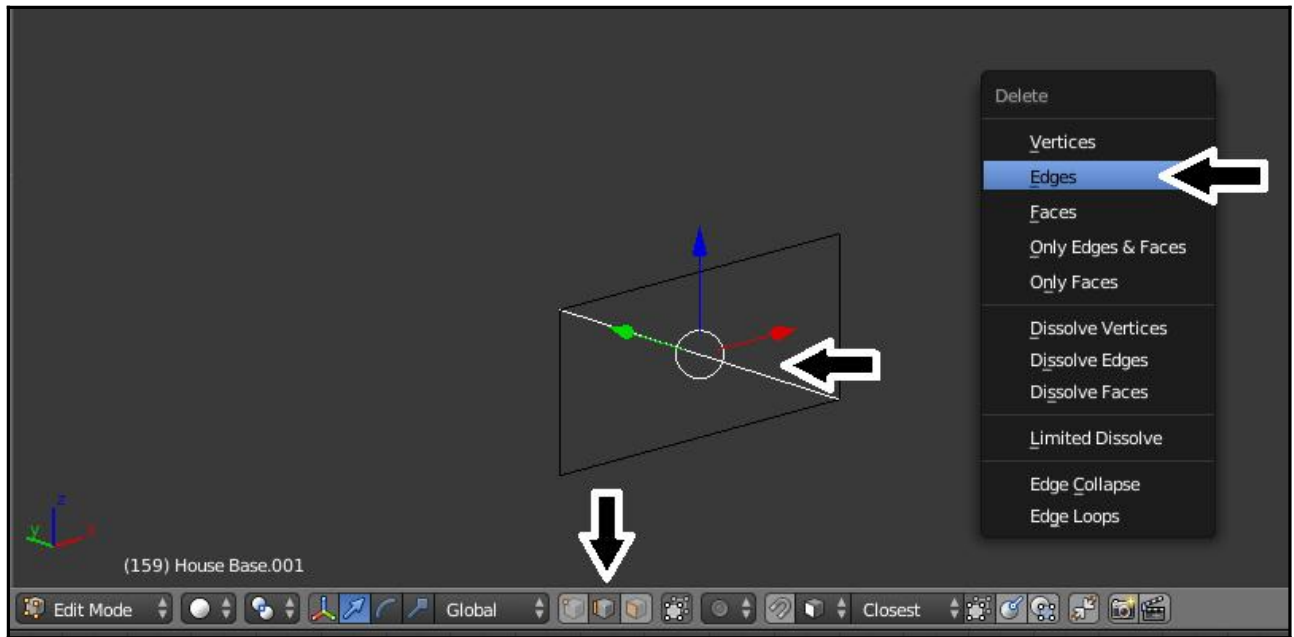

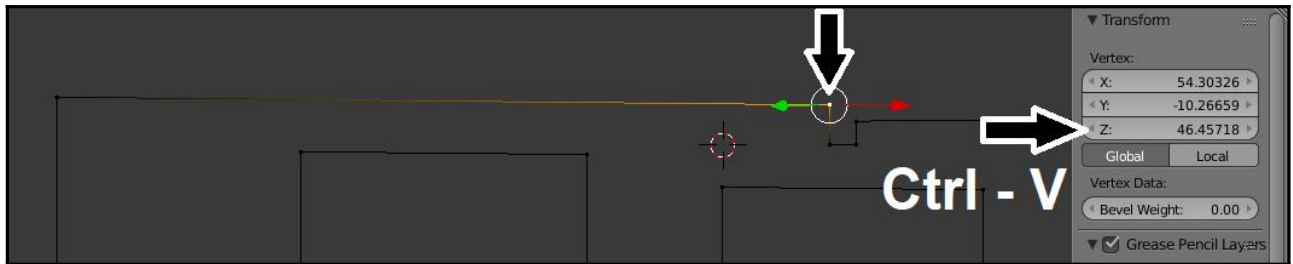
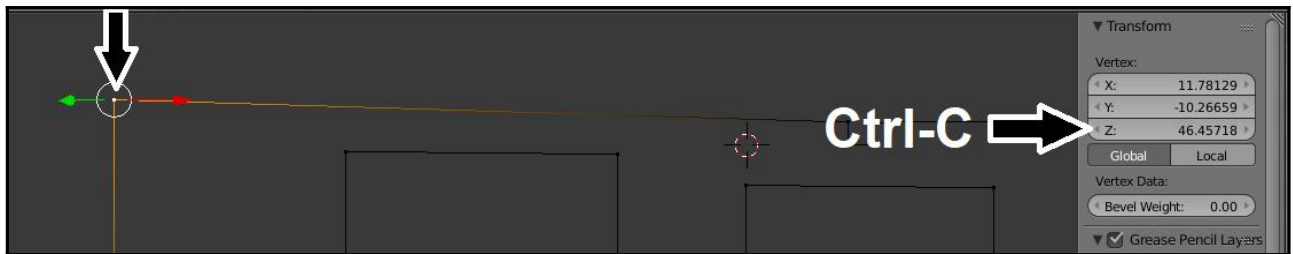
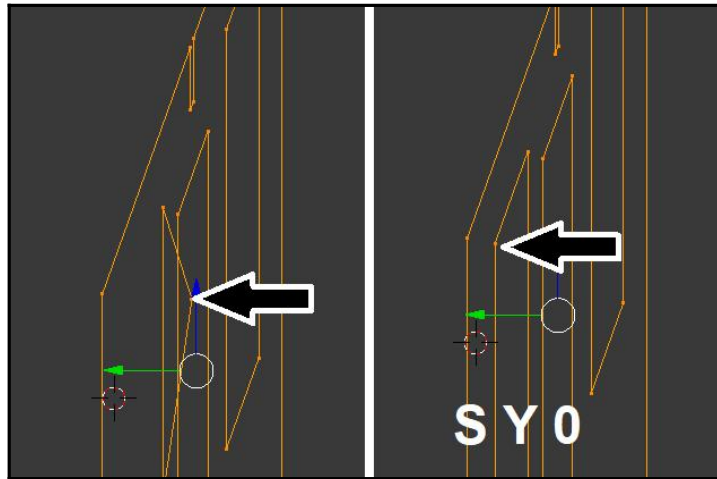

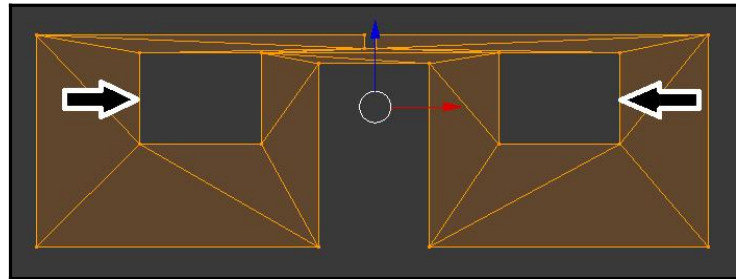
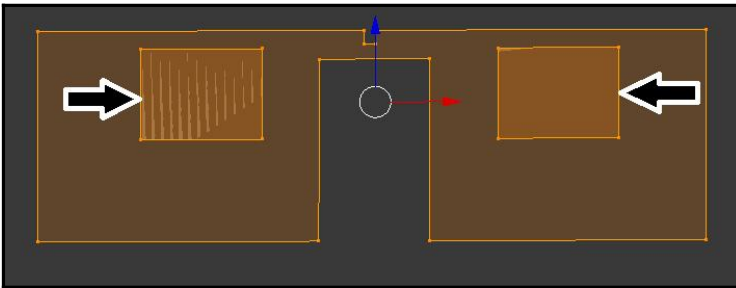
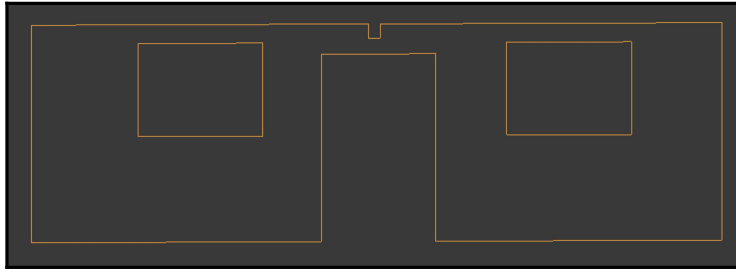

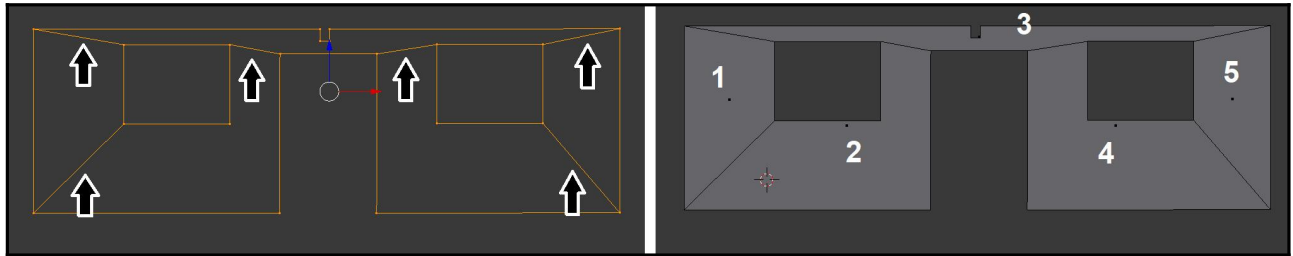
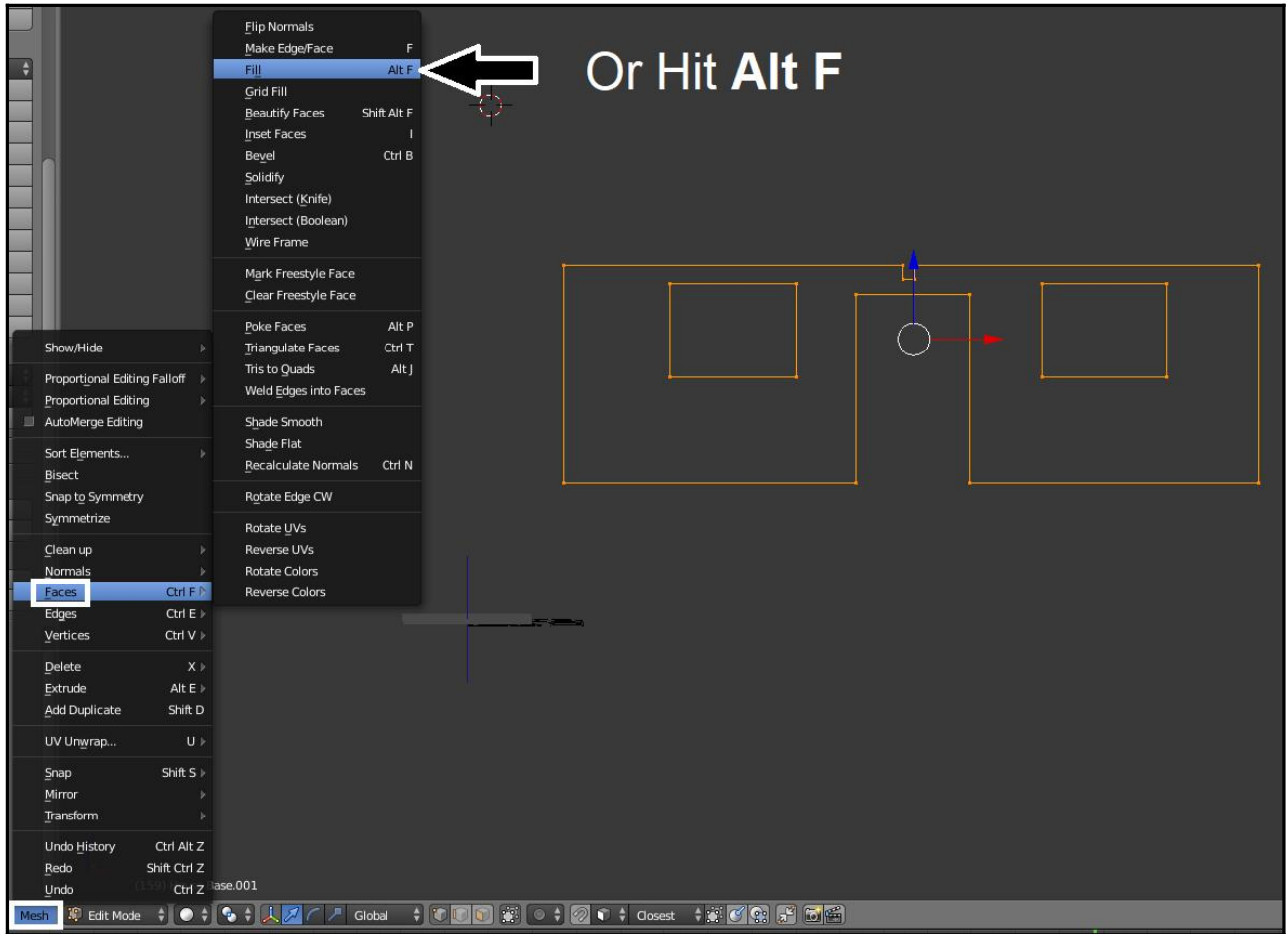



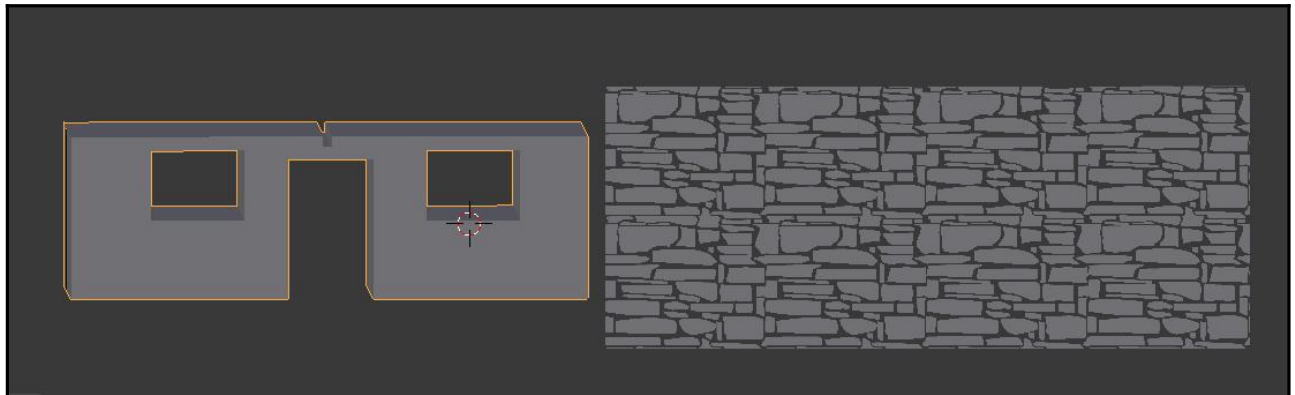
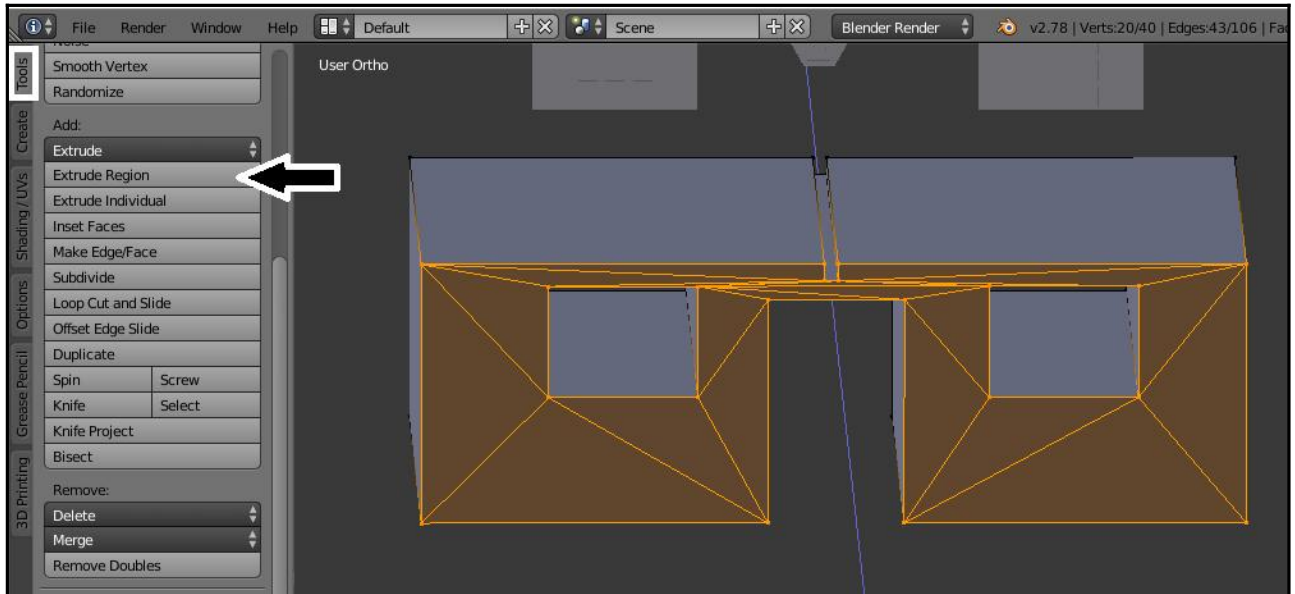

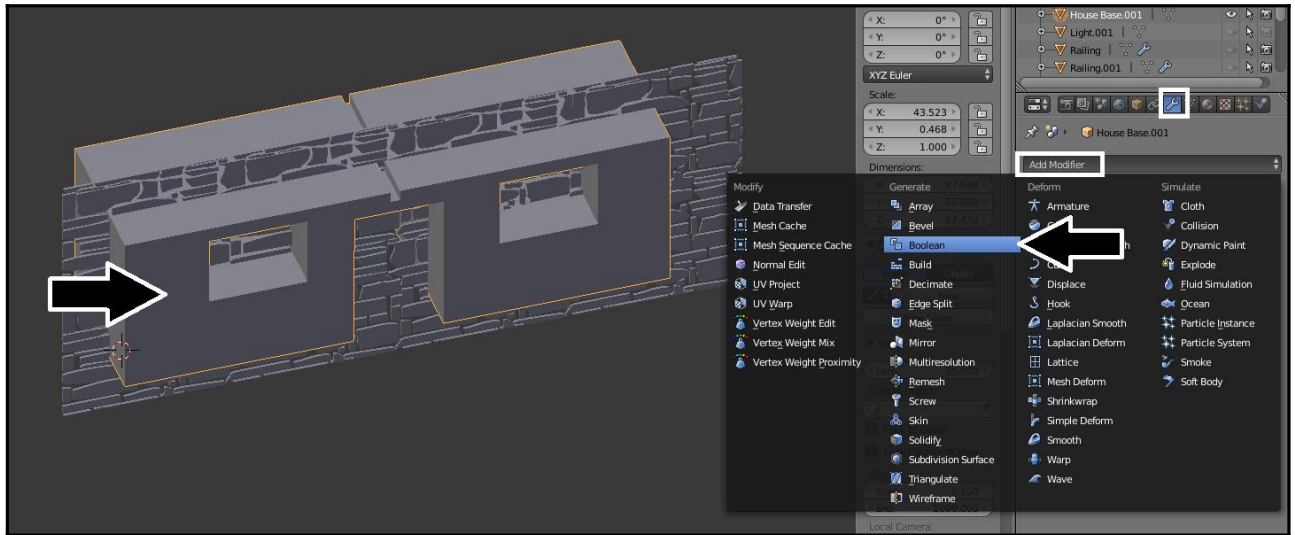
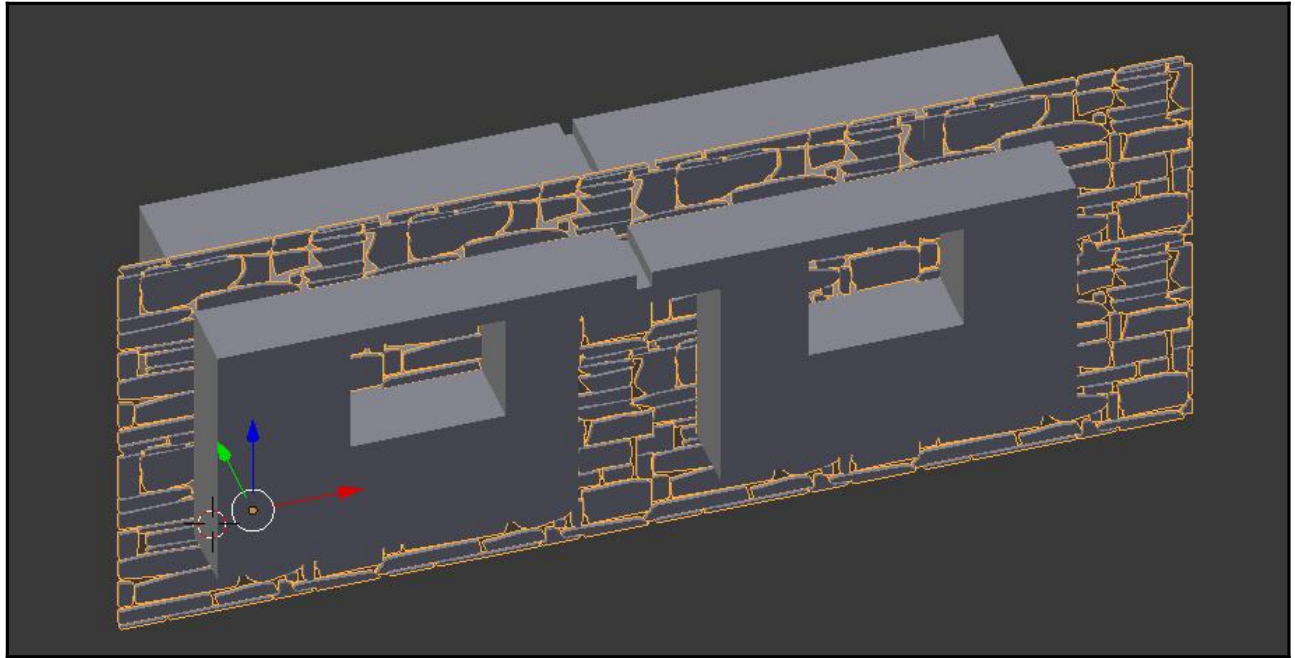

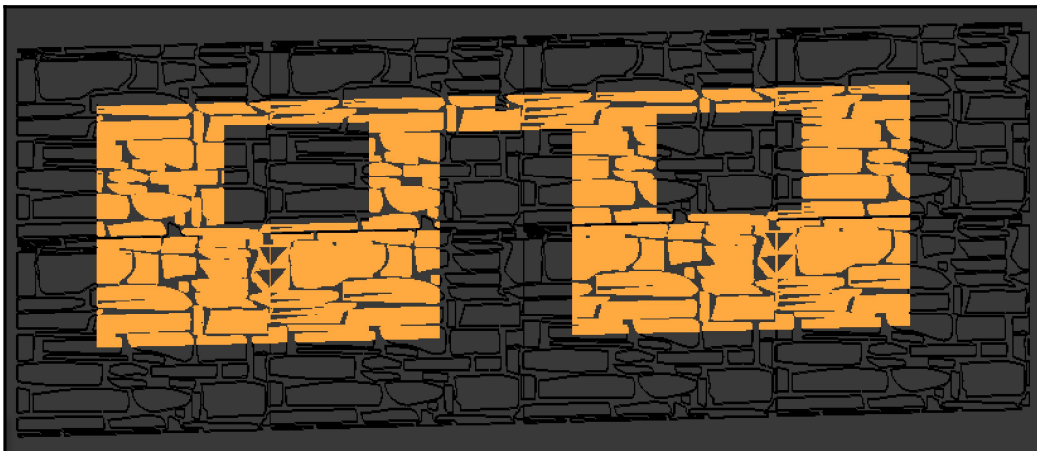
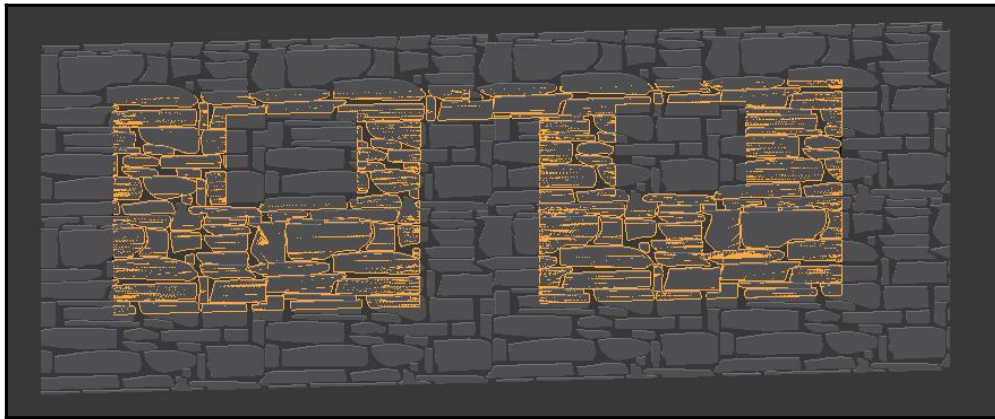
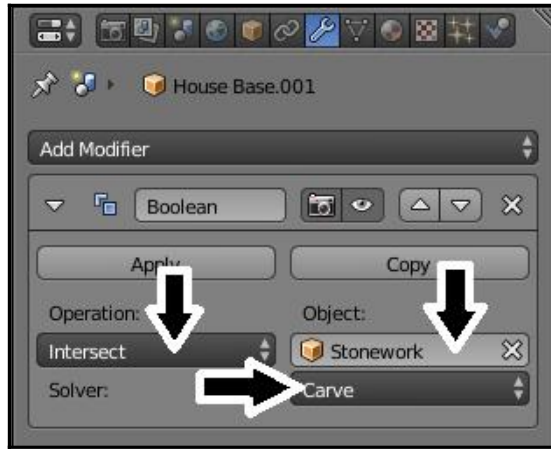

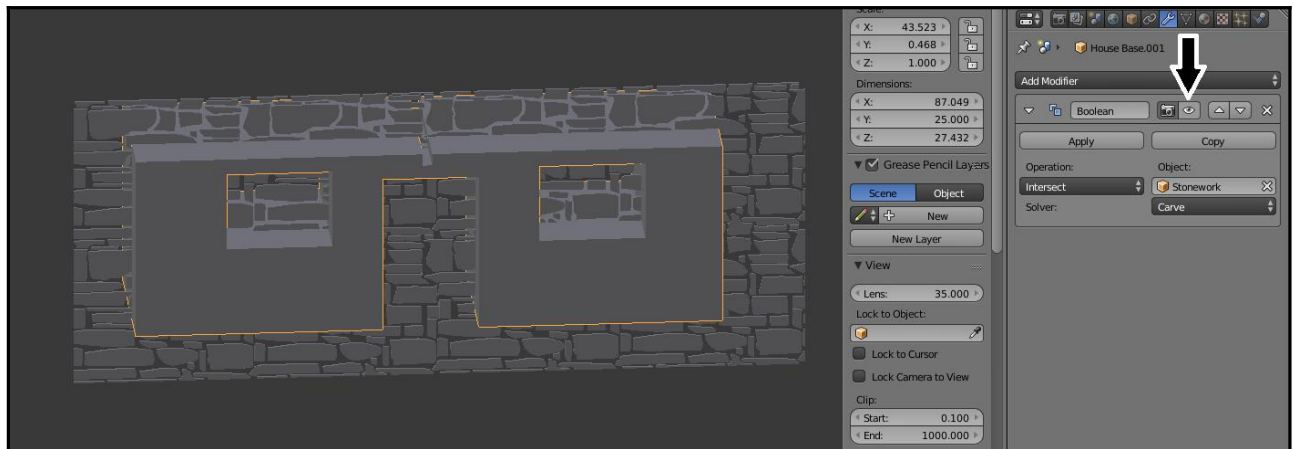
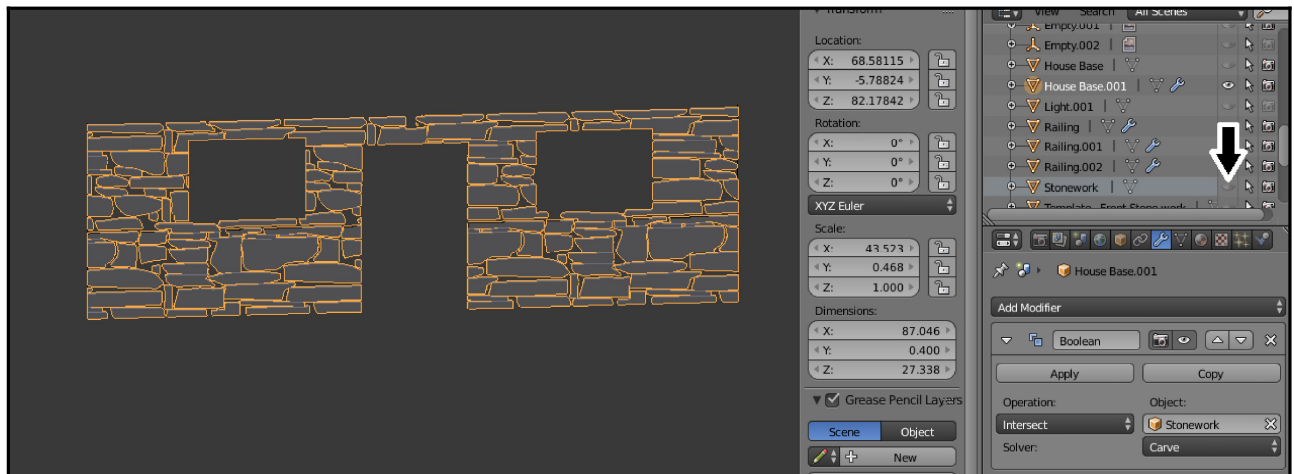

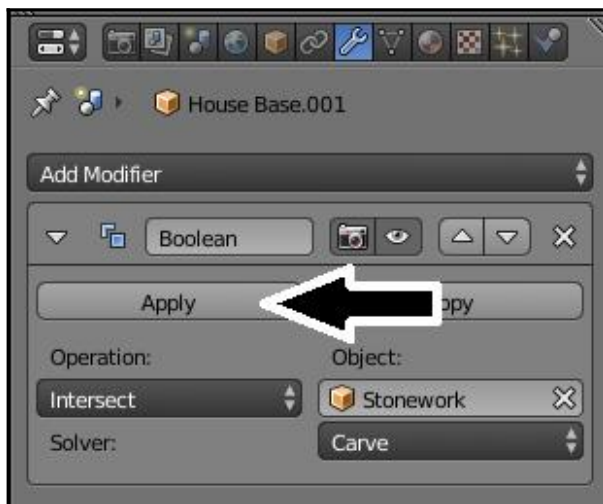
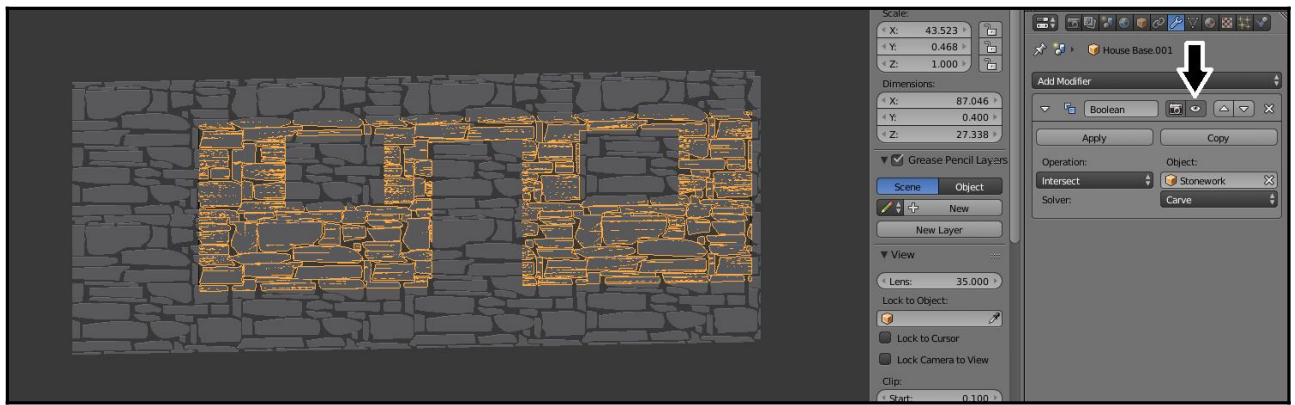

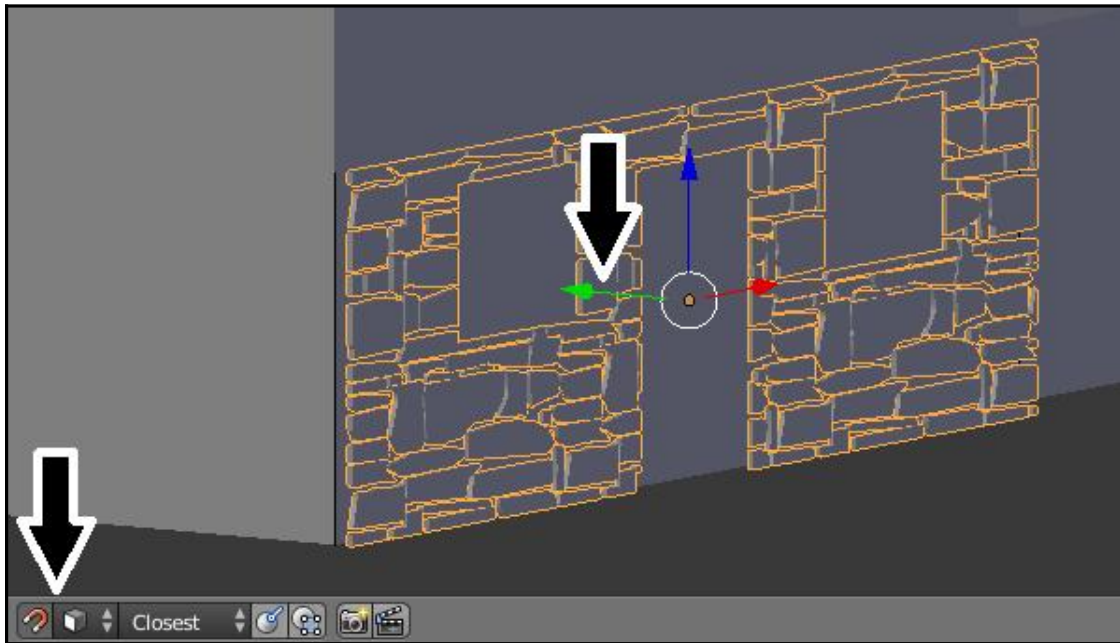
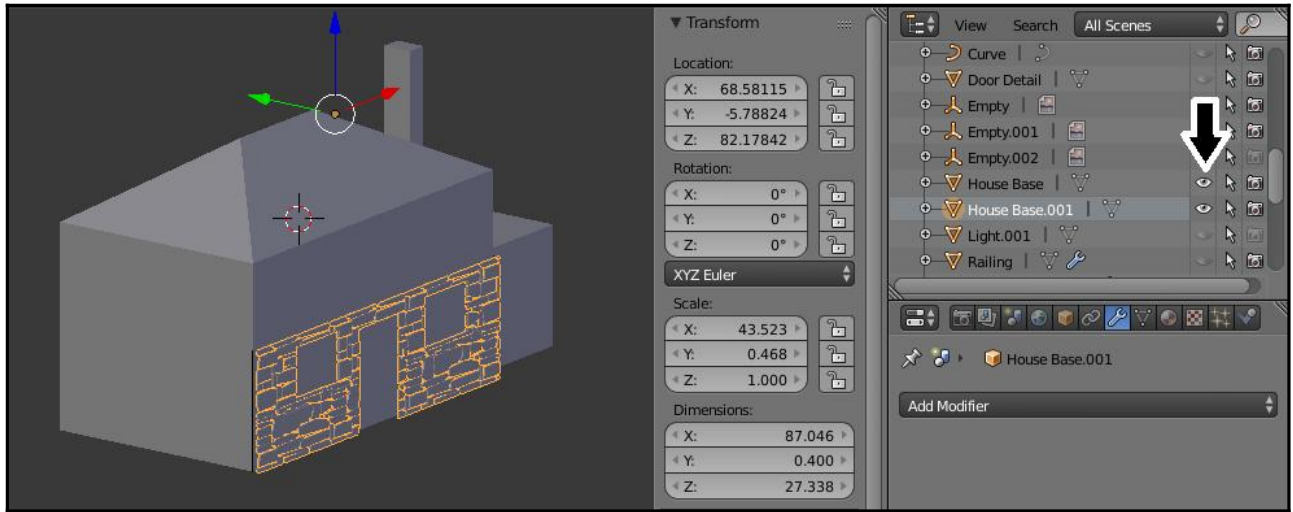

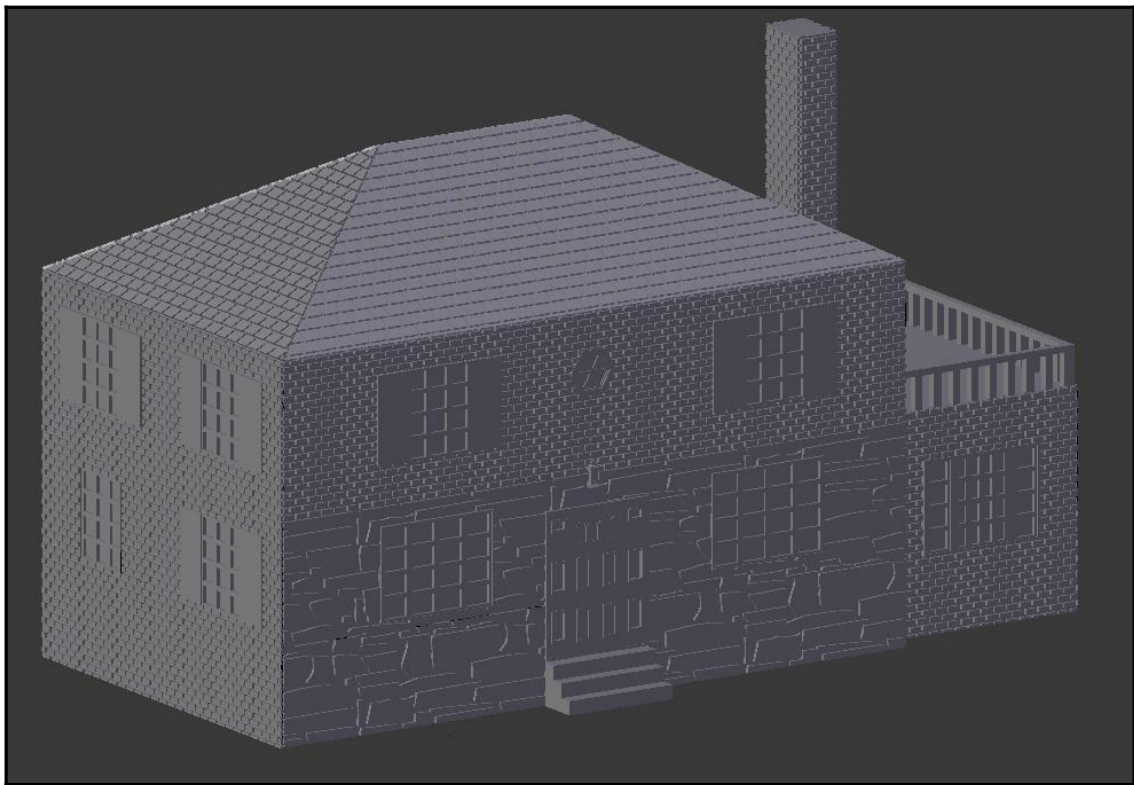
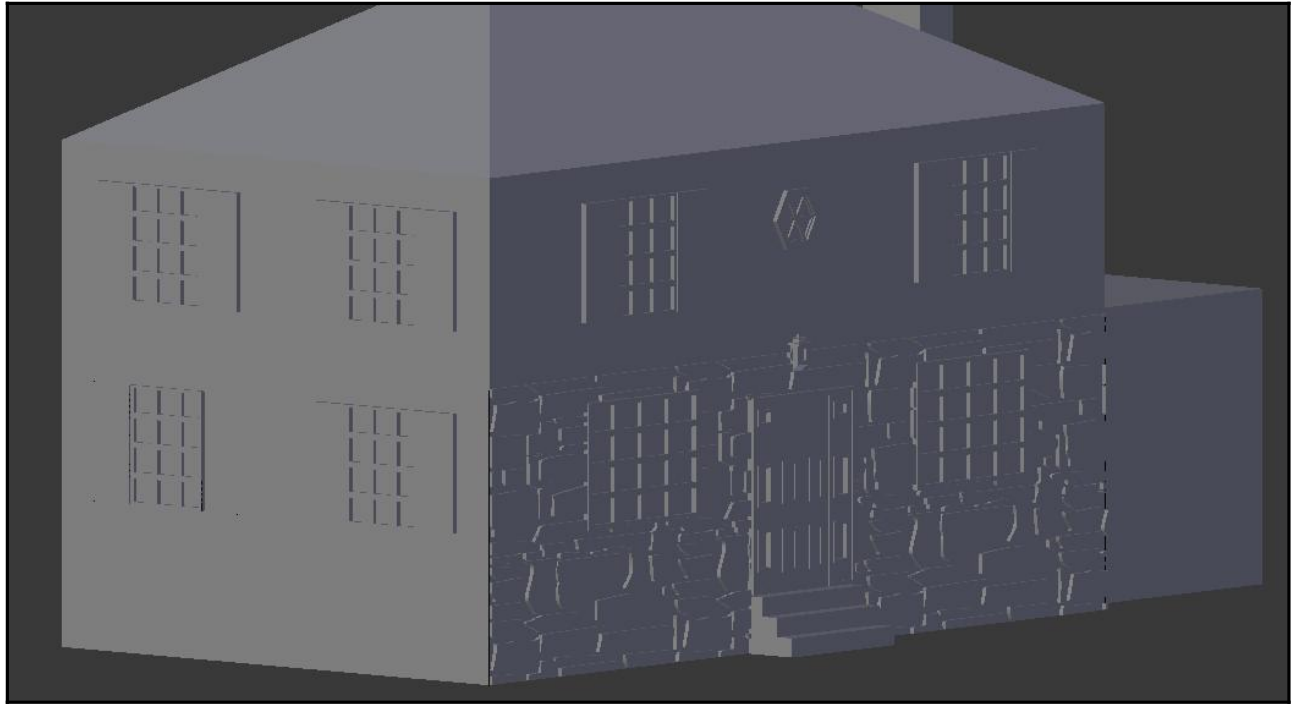

# Chapter 12: Making Organic Shapes with the Subdivision Surface Modifier

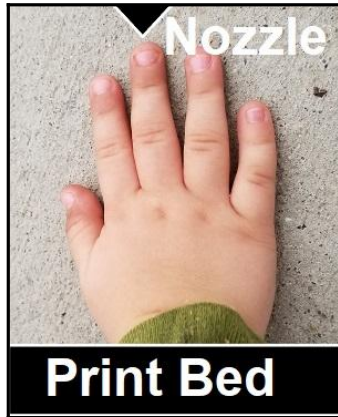



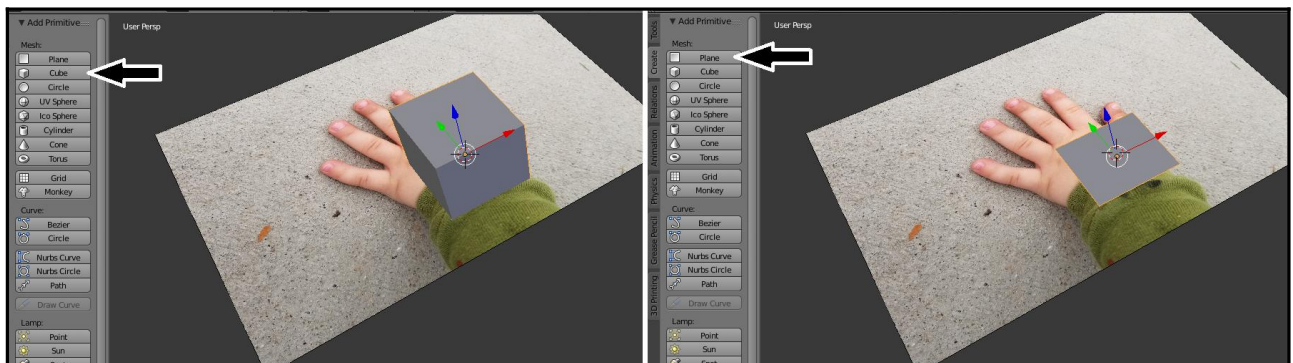
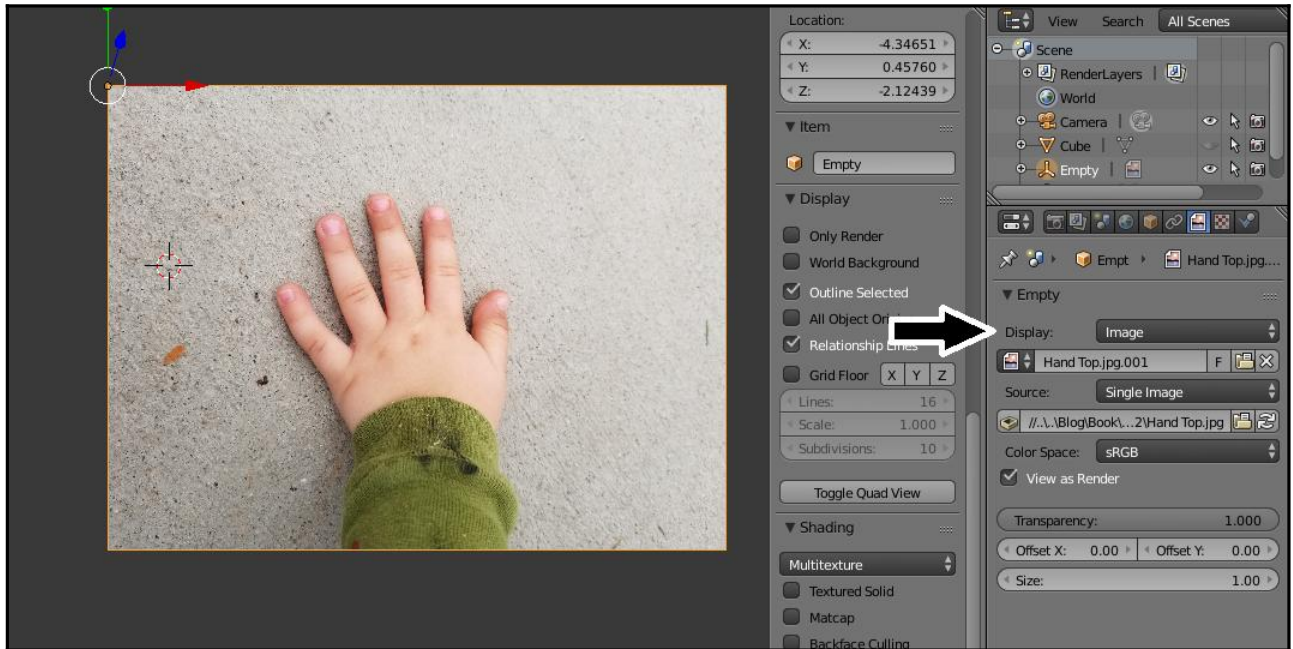
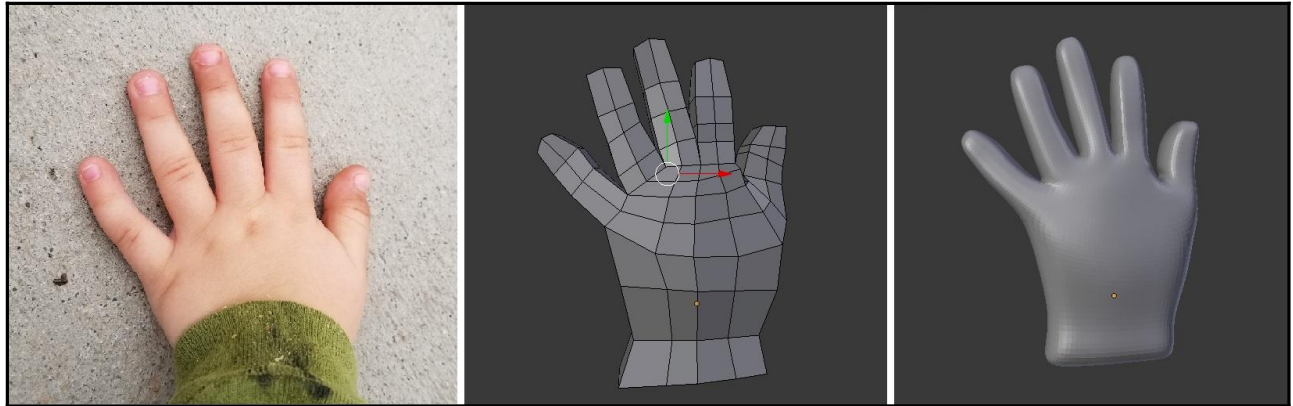

S Z to Scale Along Z Axis

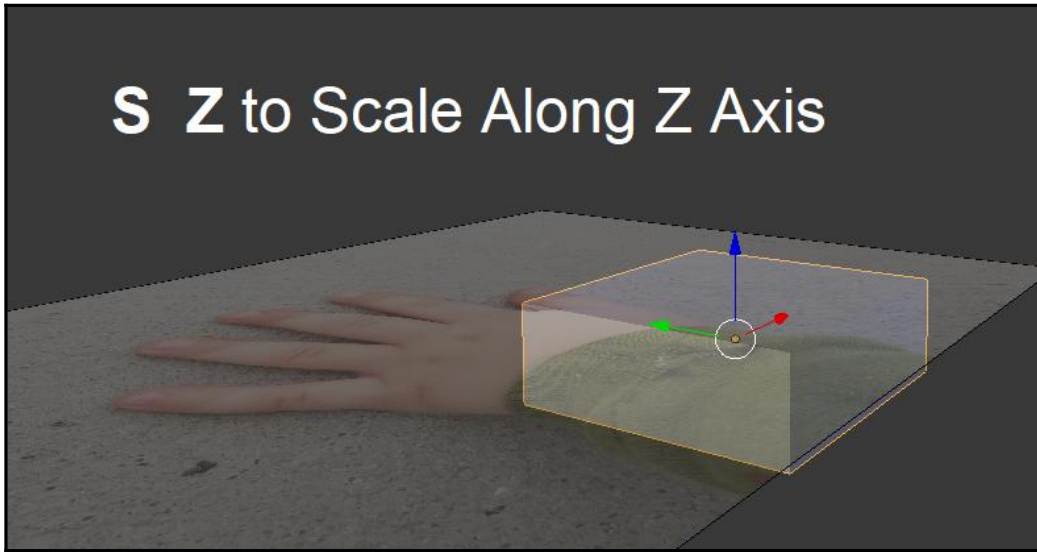

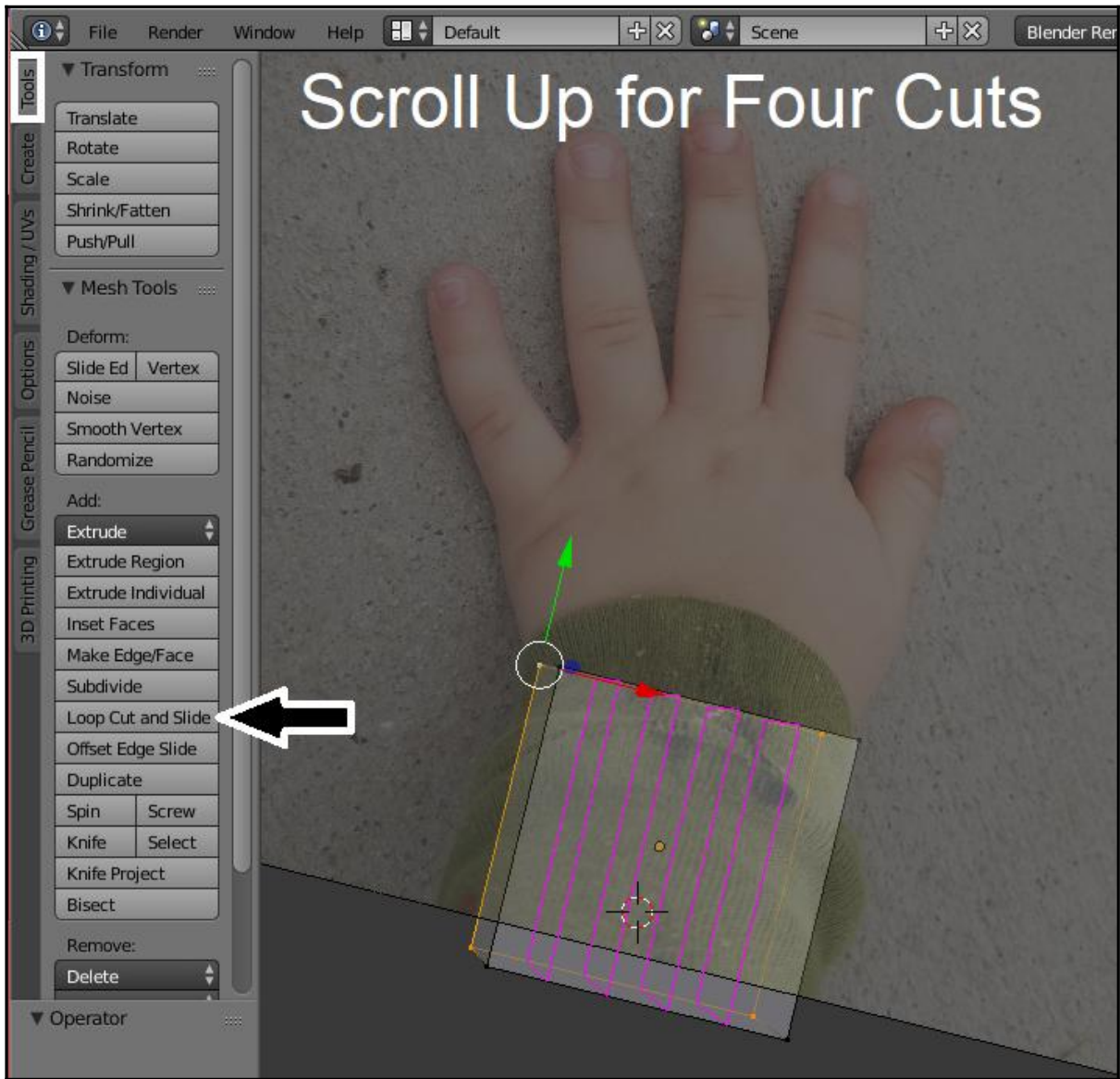

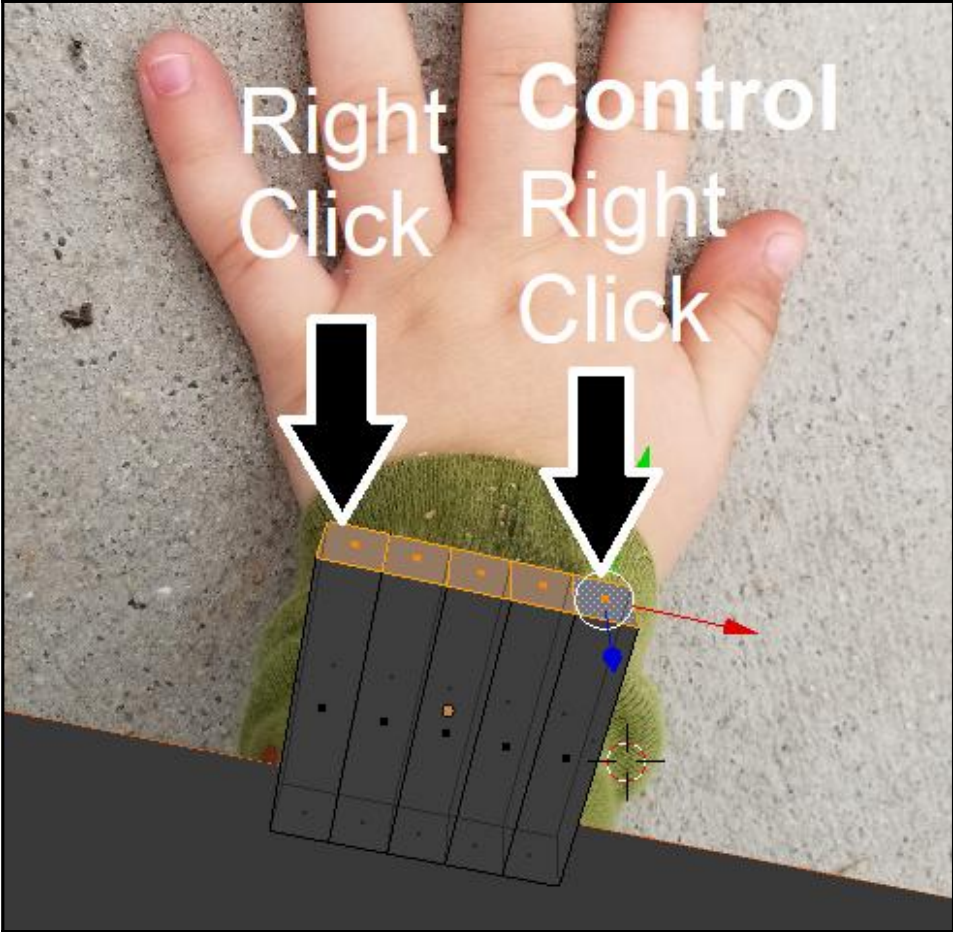

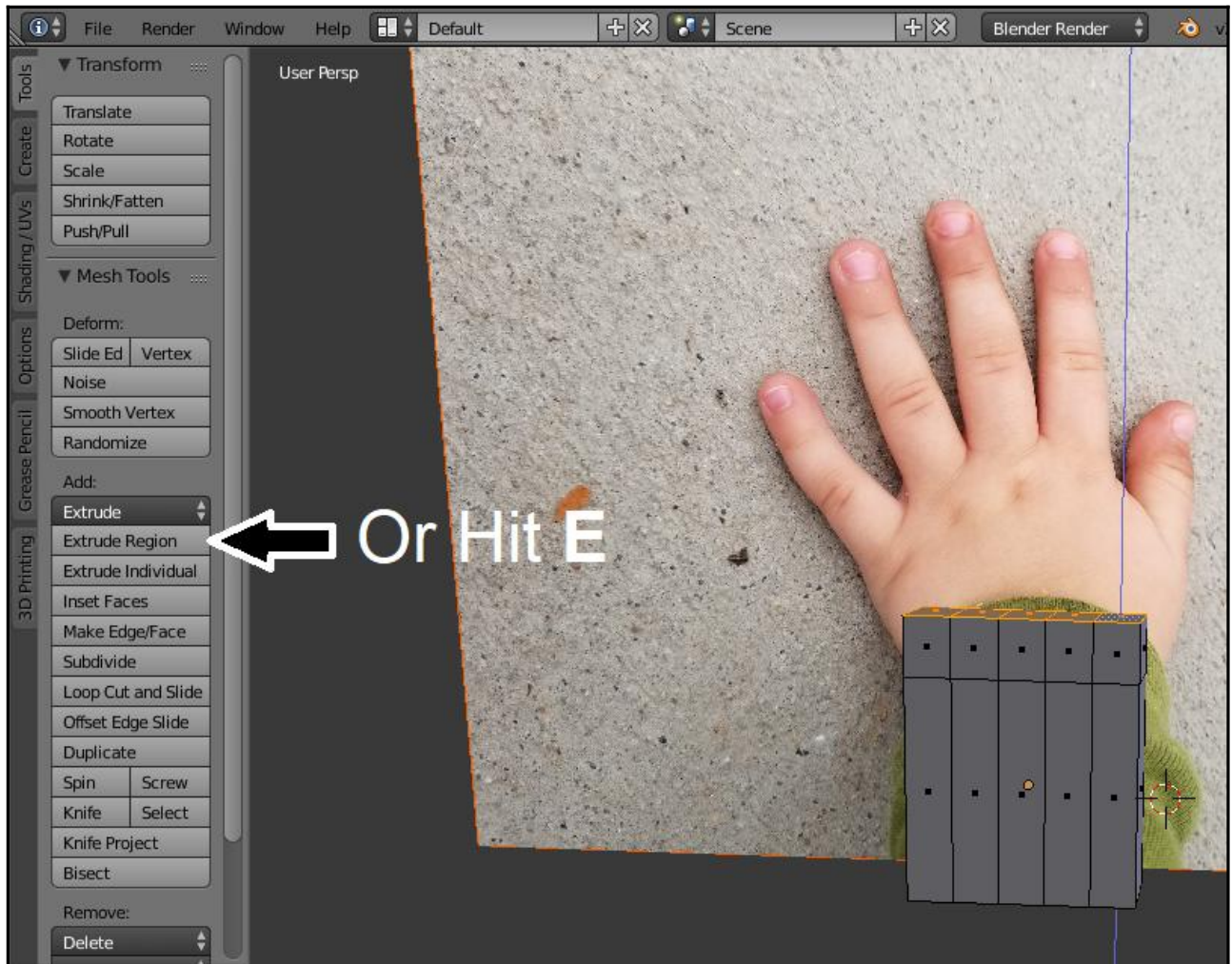

Hit S to Scale

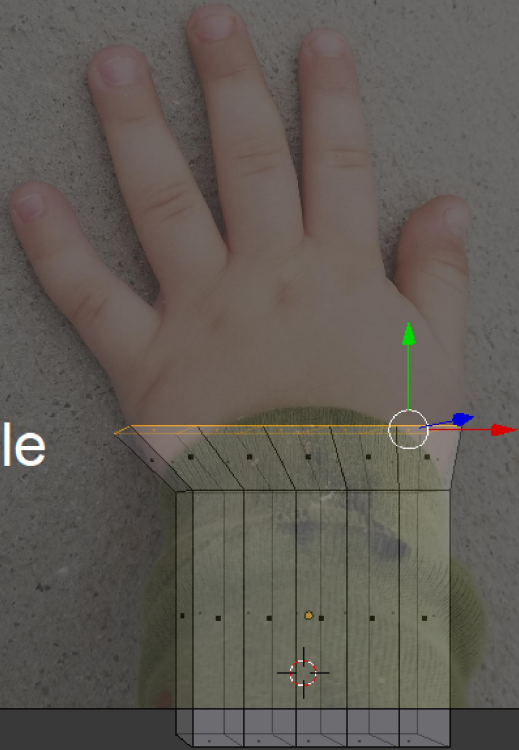

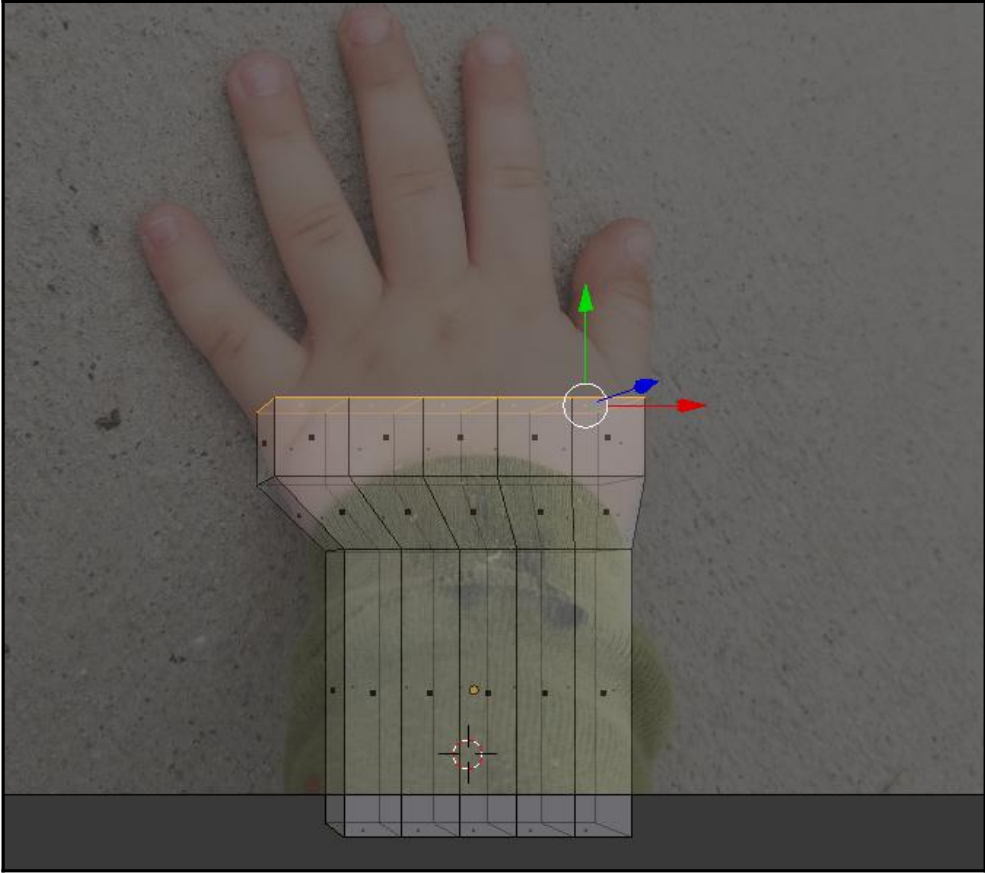

R and Z to Rotate  
Around Z Axis

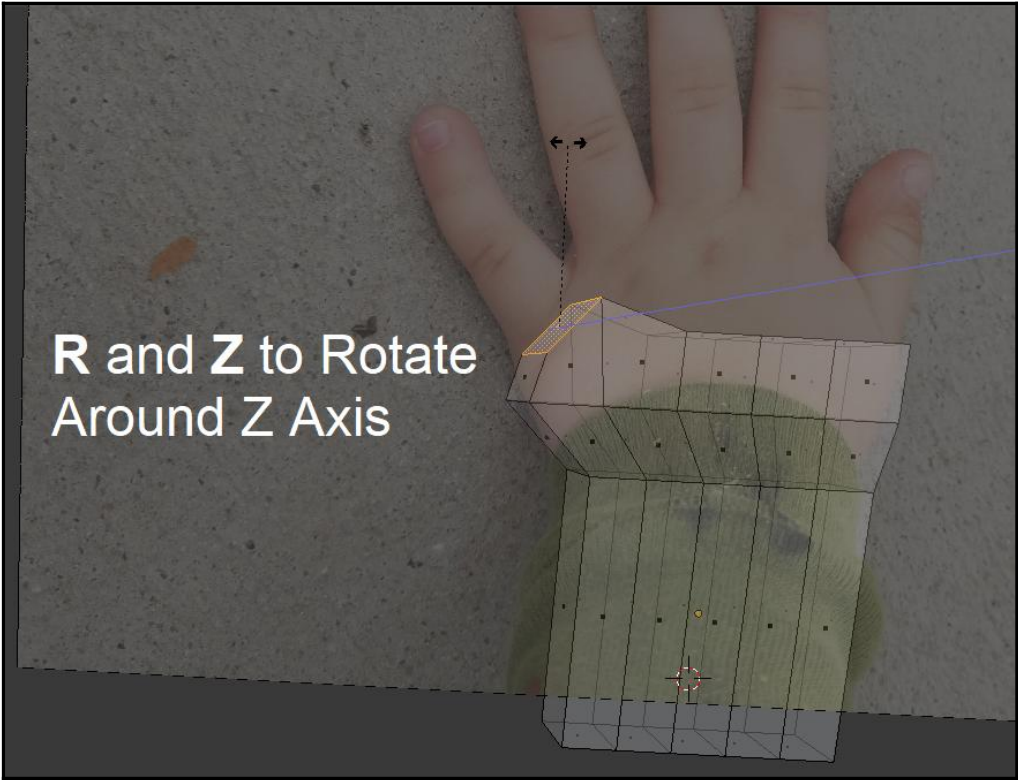



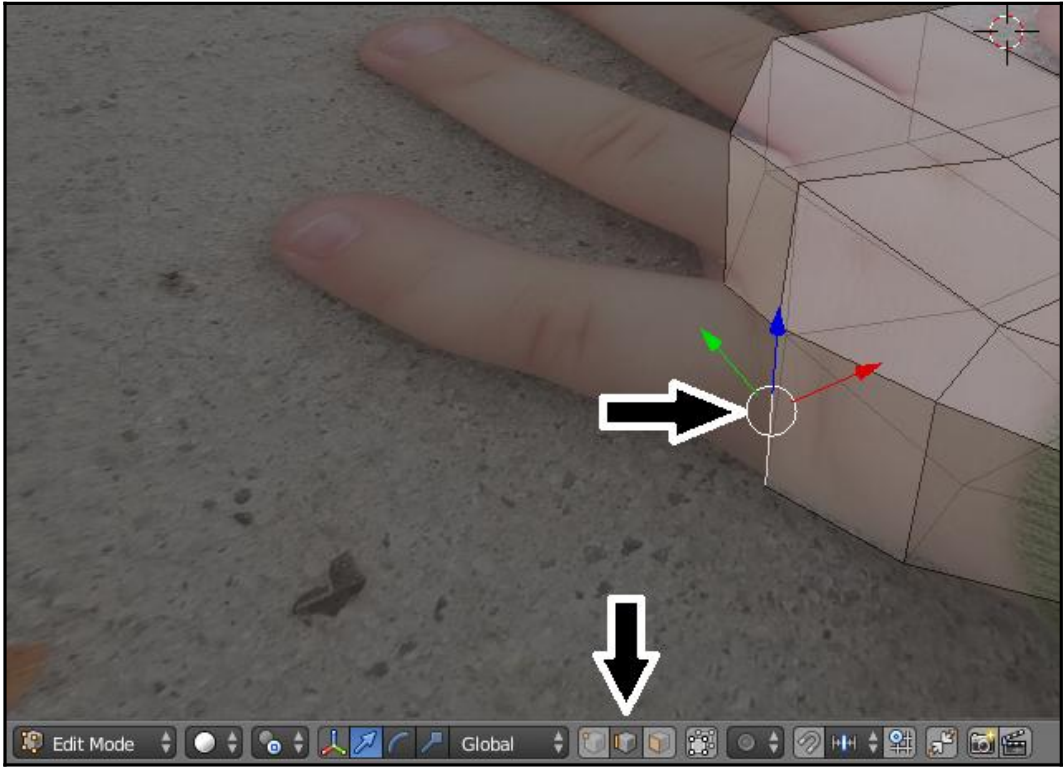

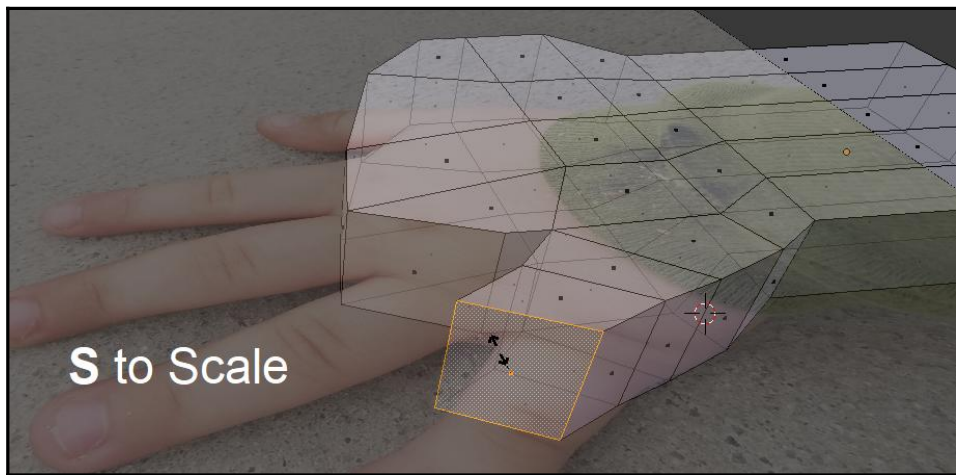
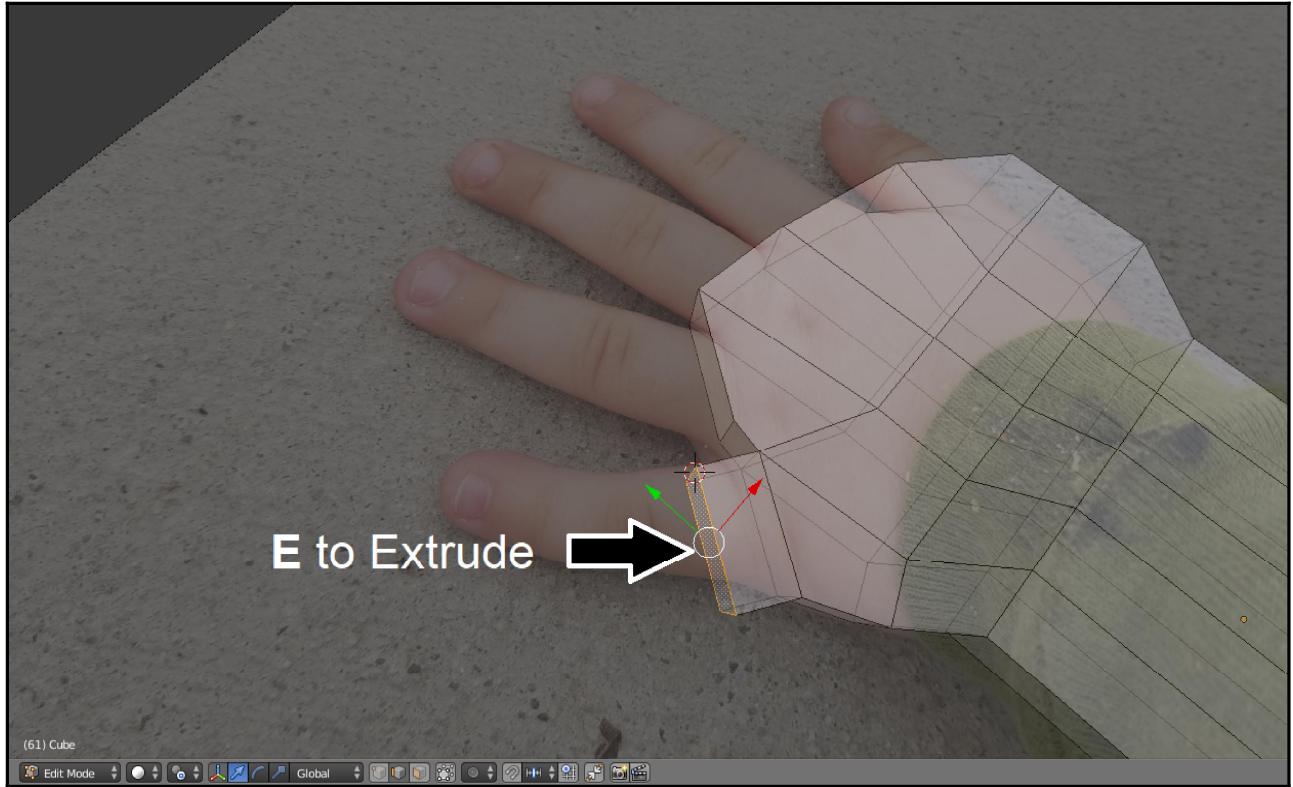

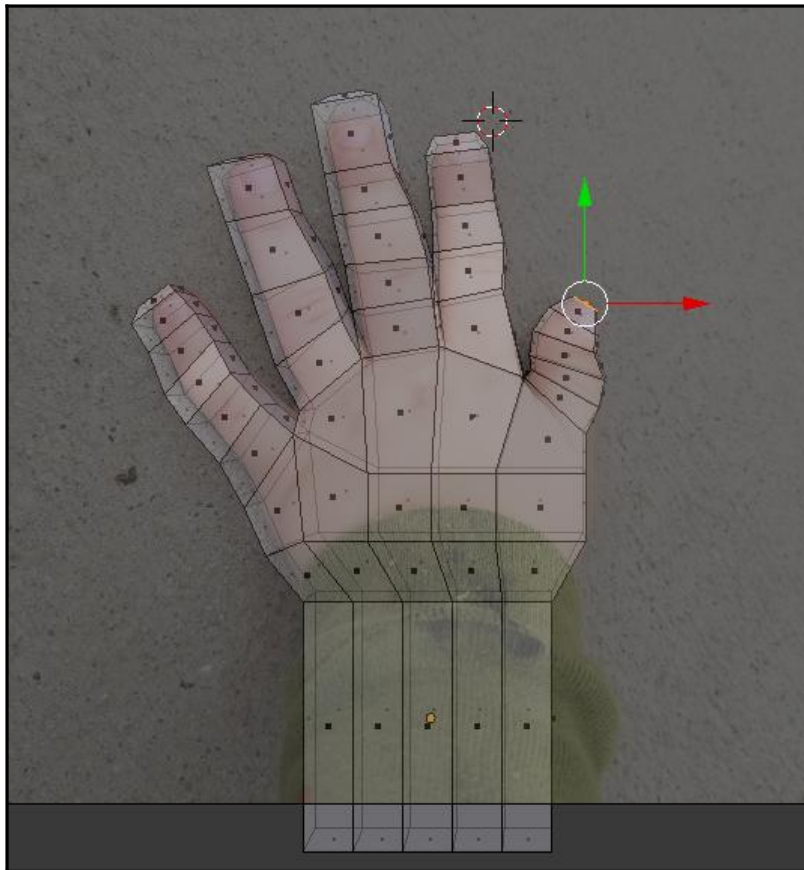
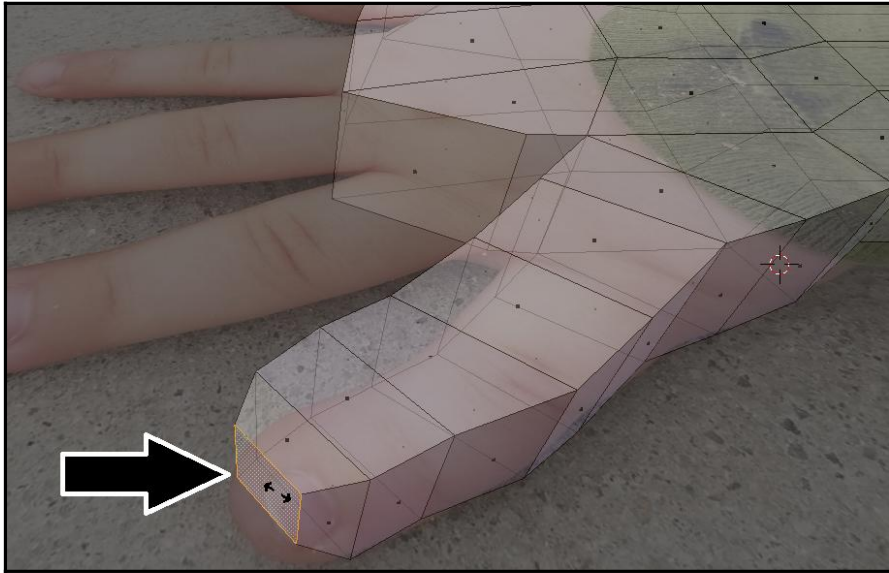

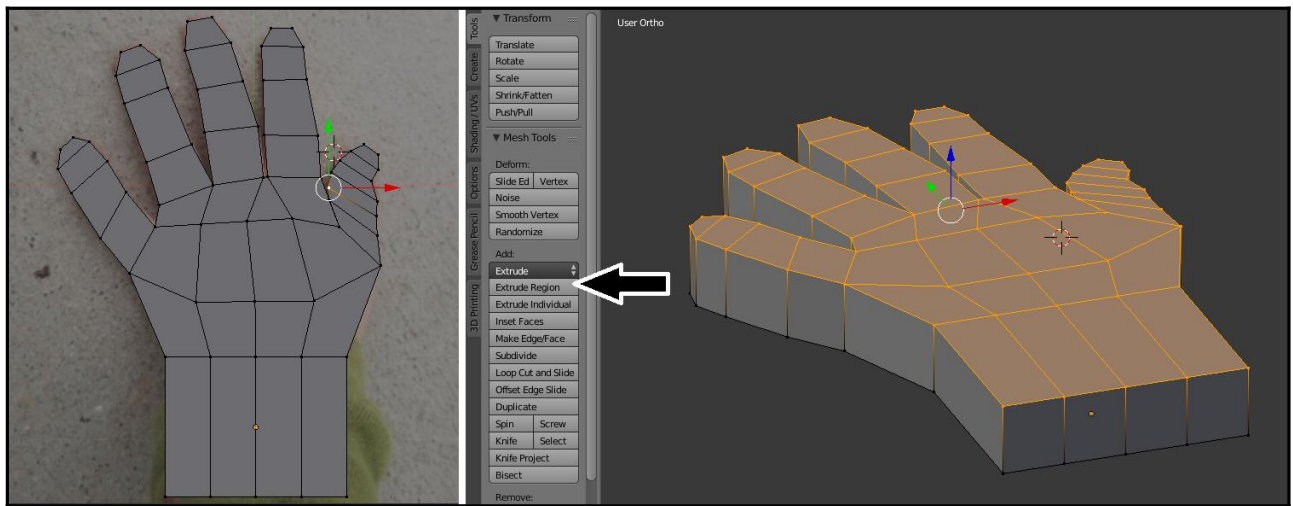
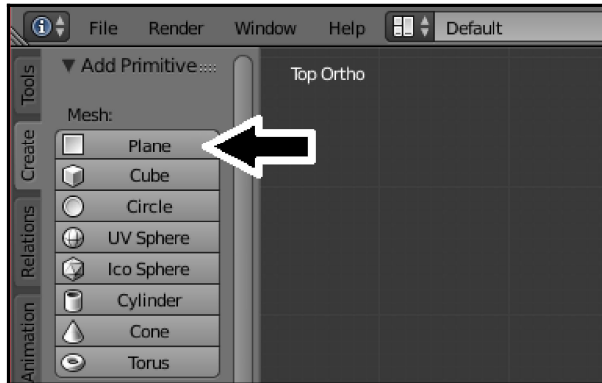

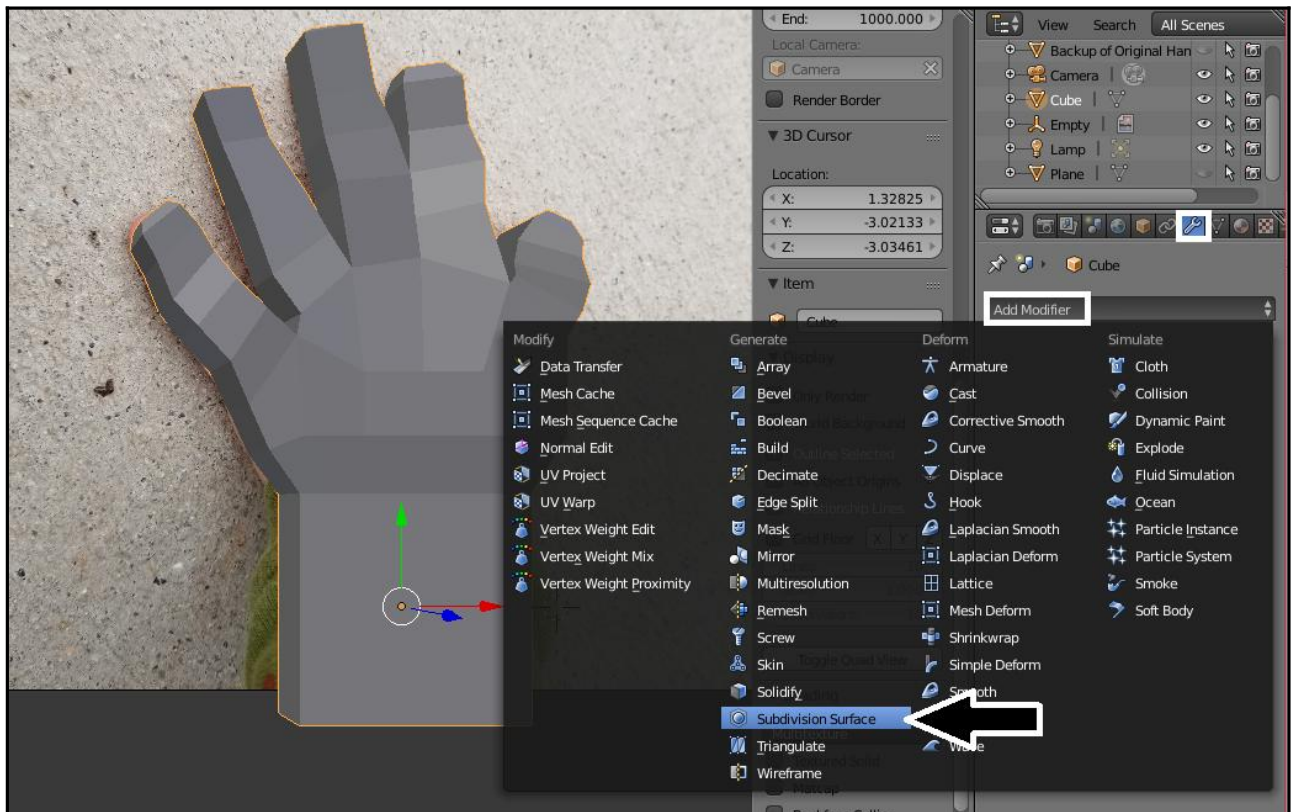
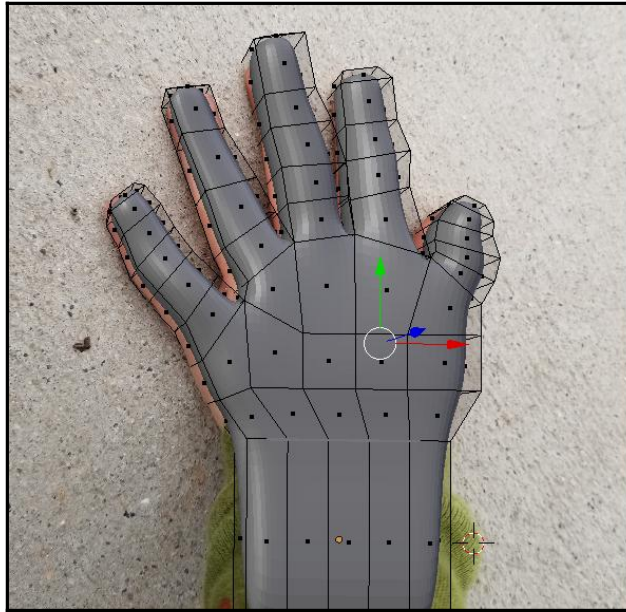

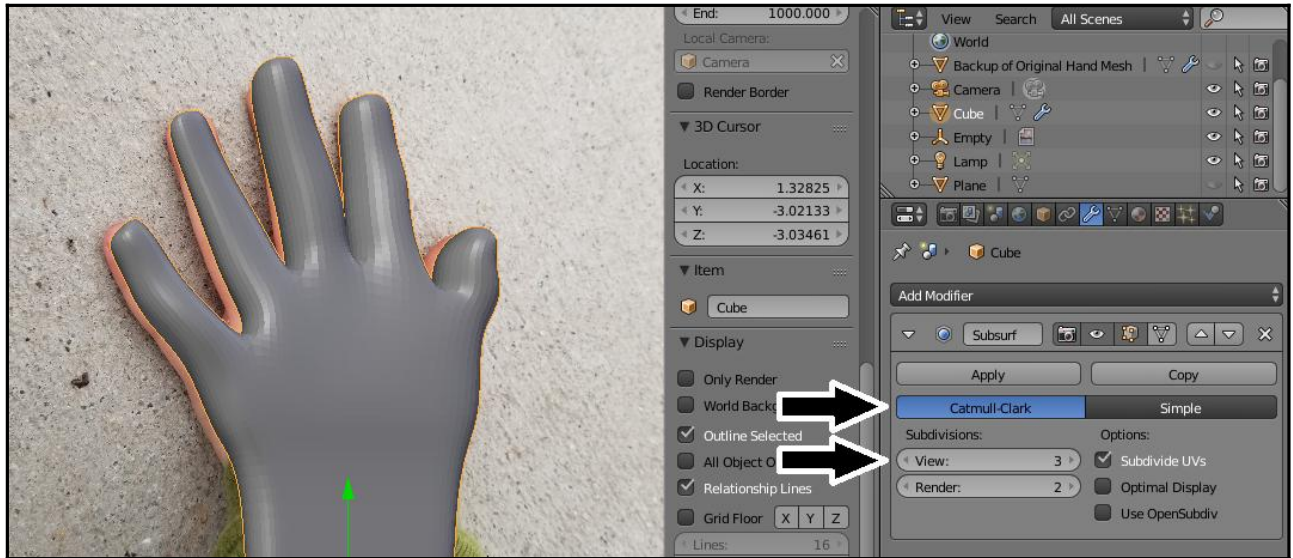

# Chapter 13: Trial and Error – Topology Edits

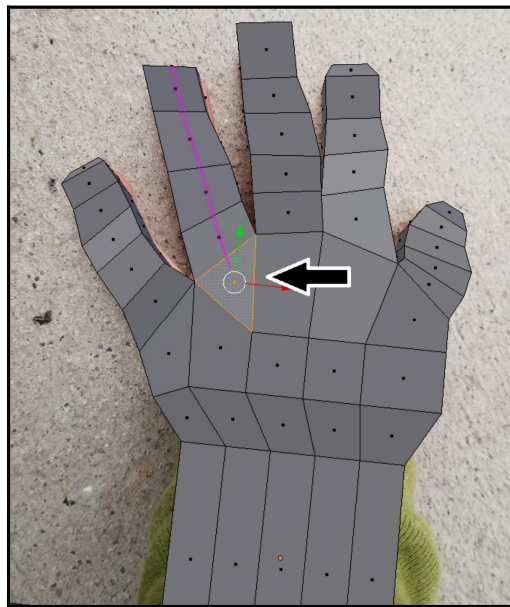
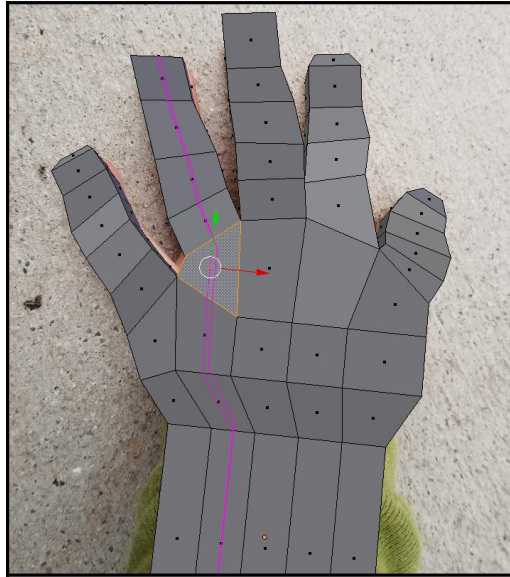

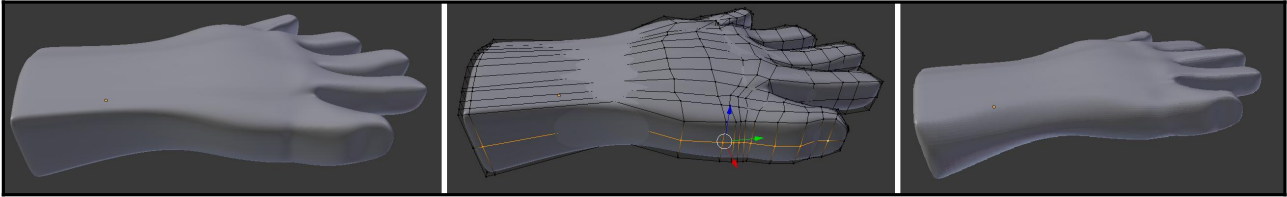
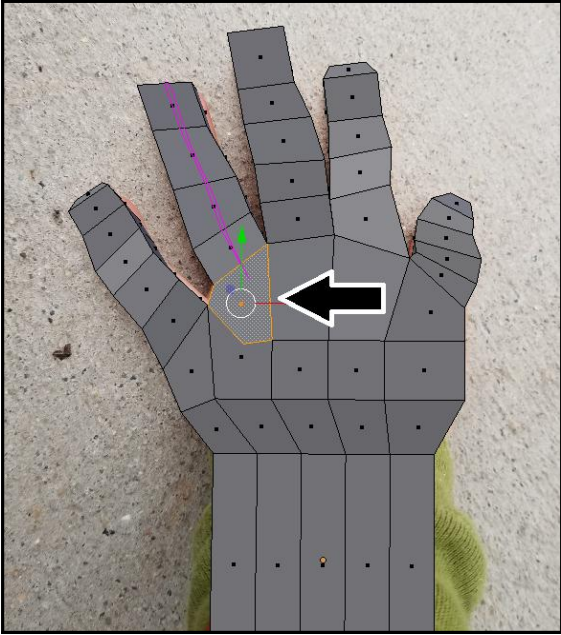



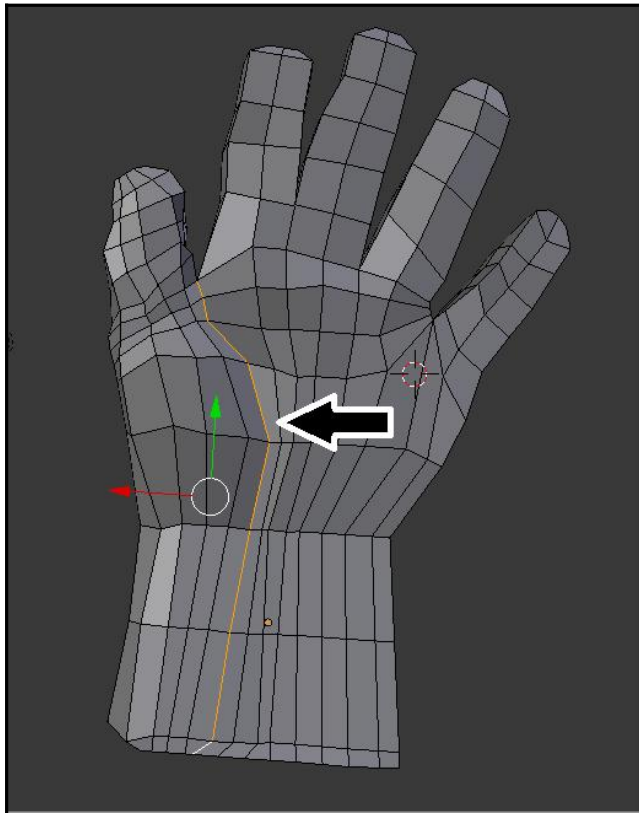
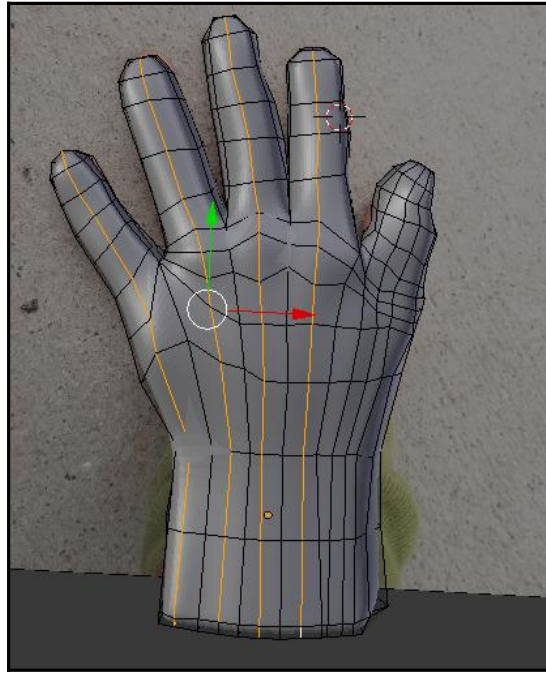

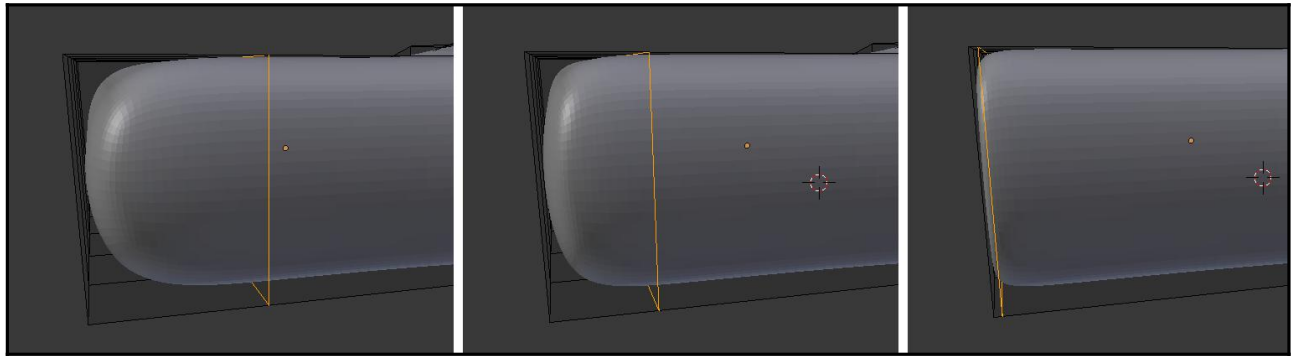
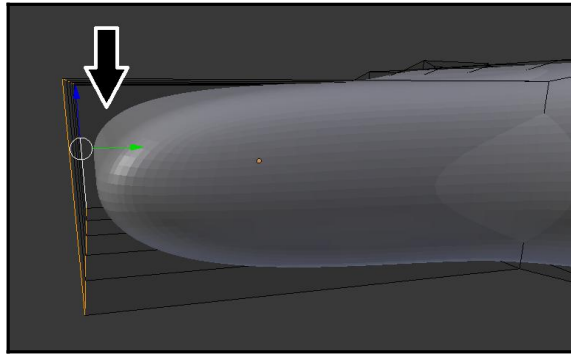
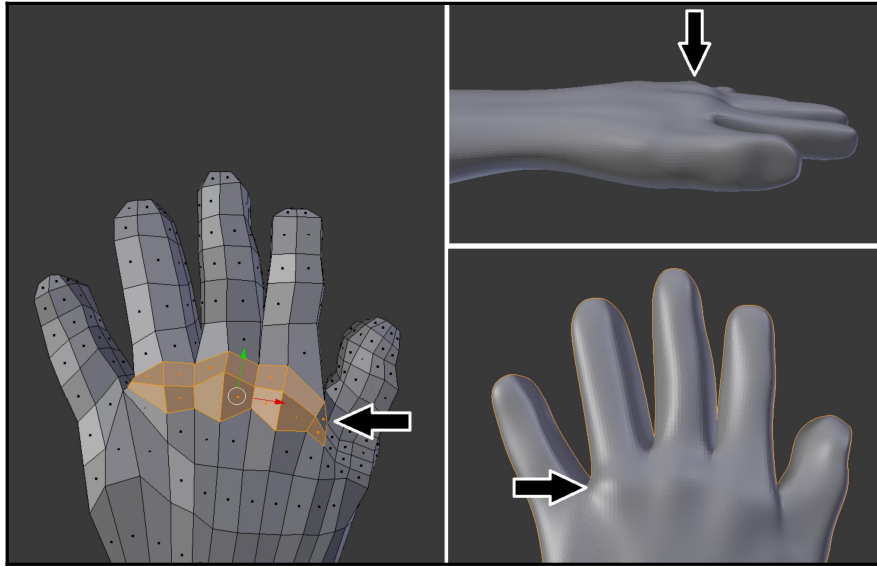

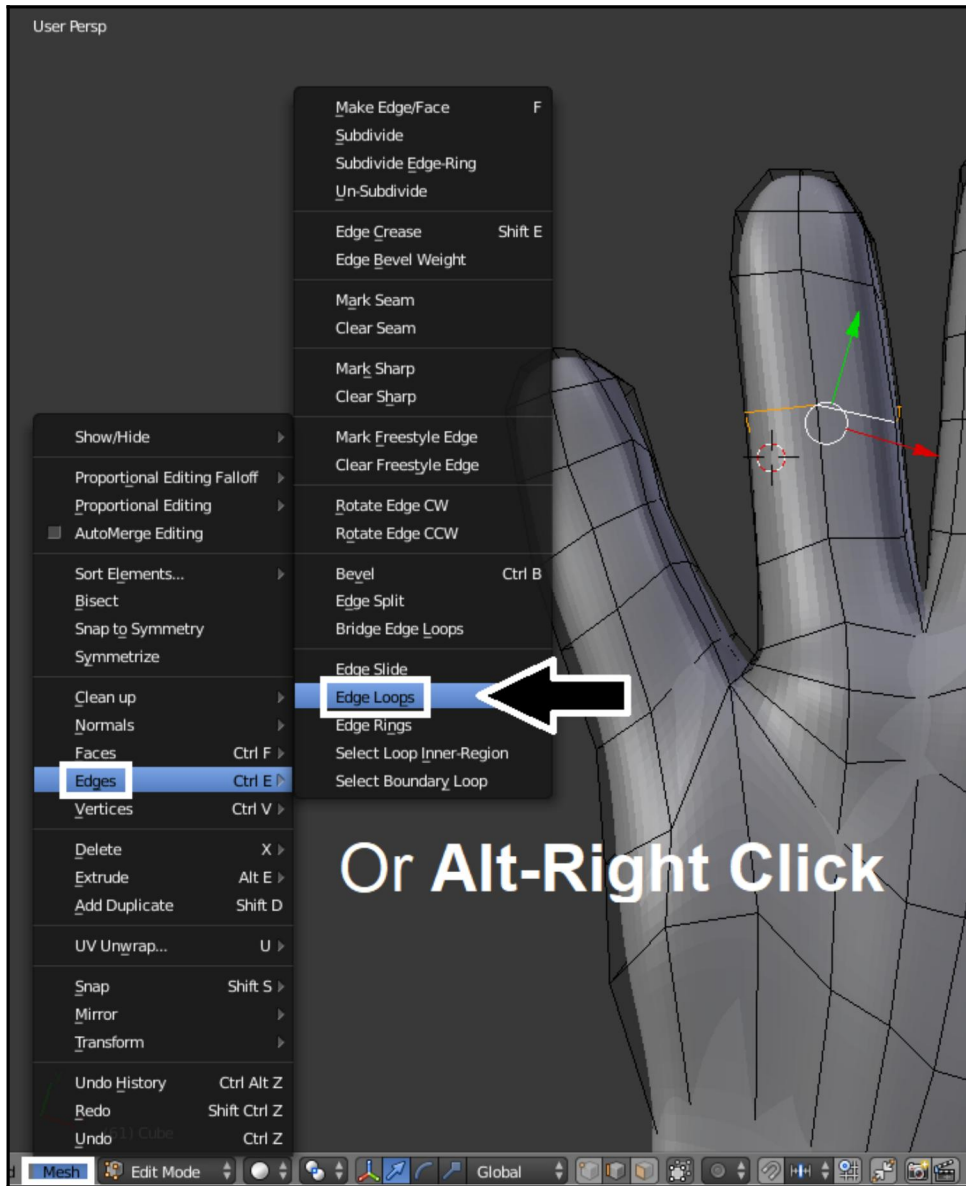
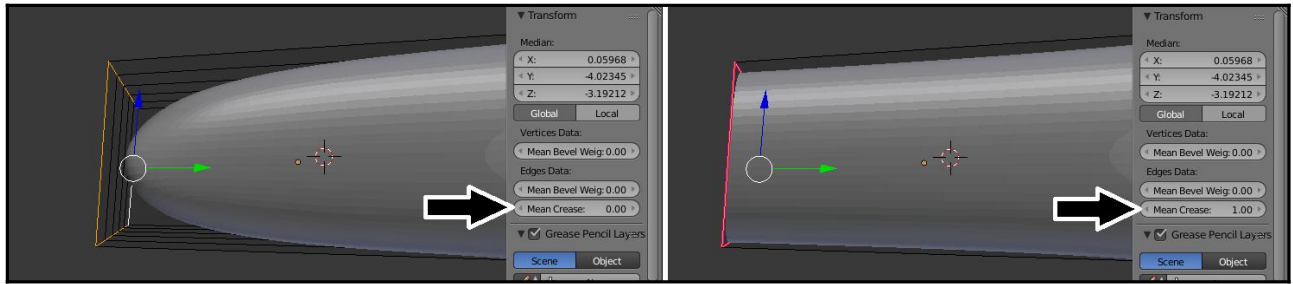

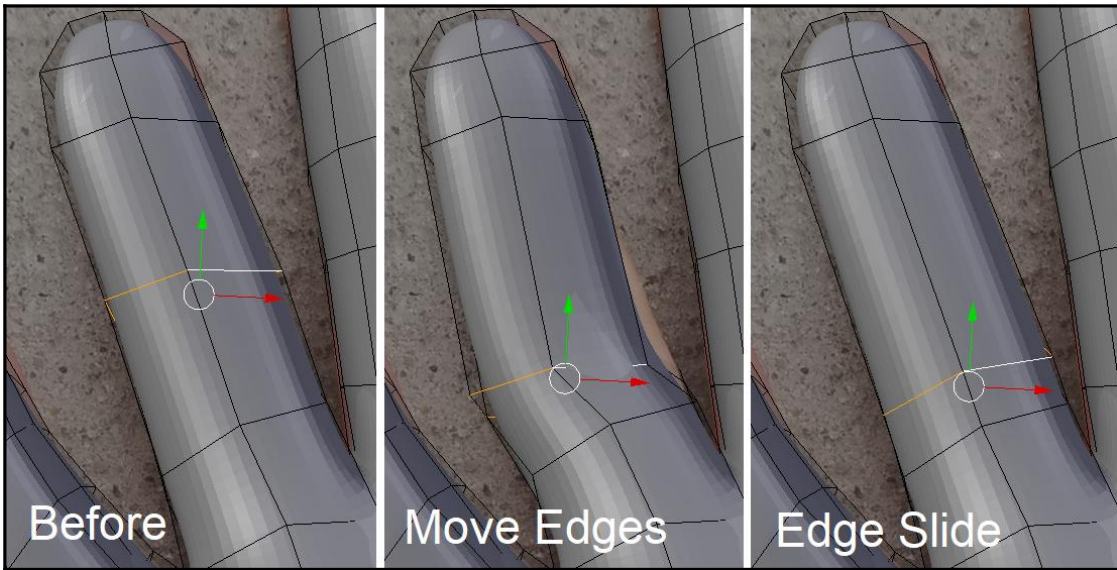
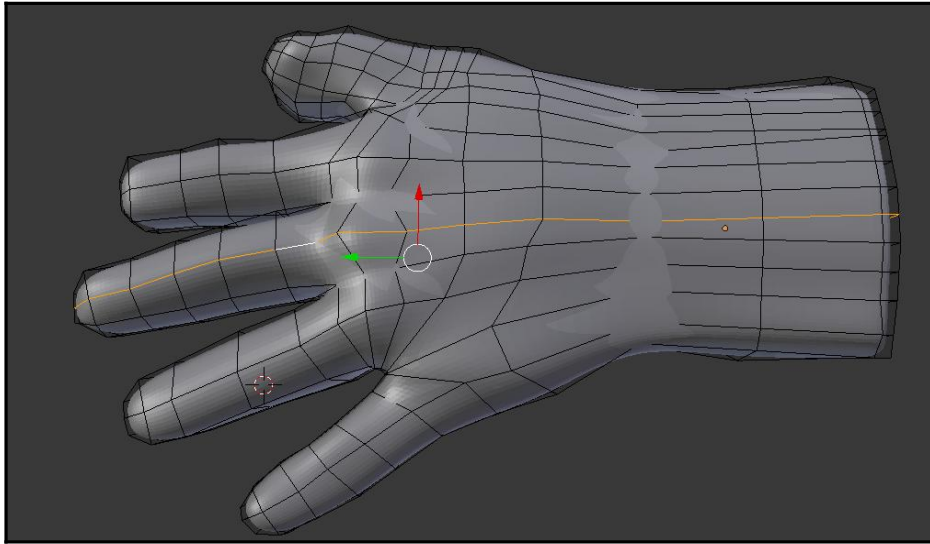

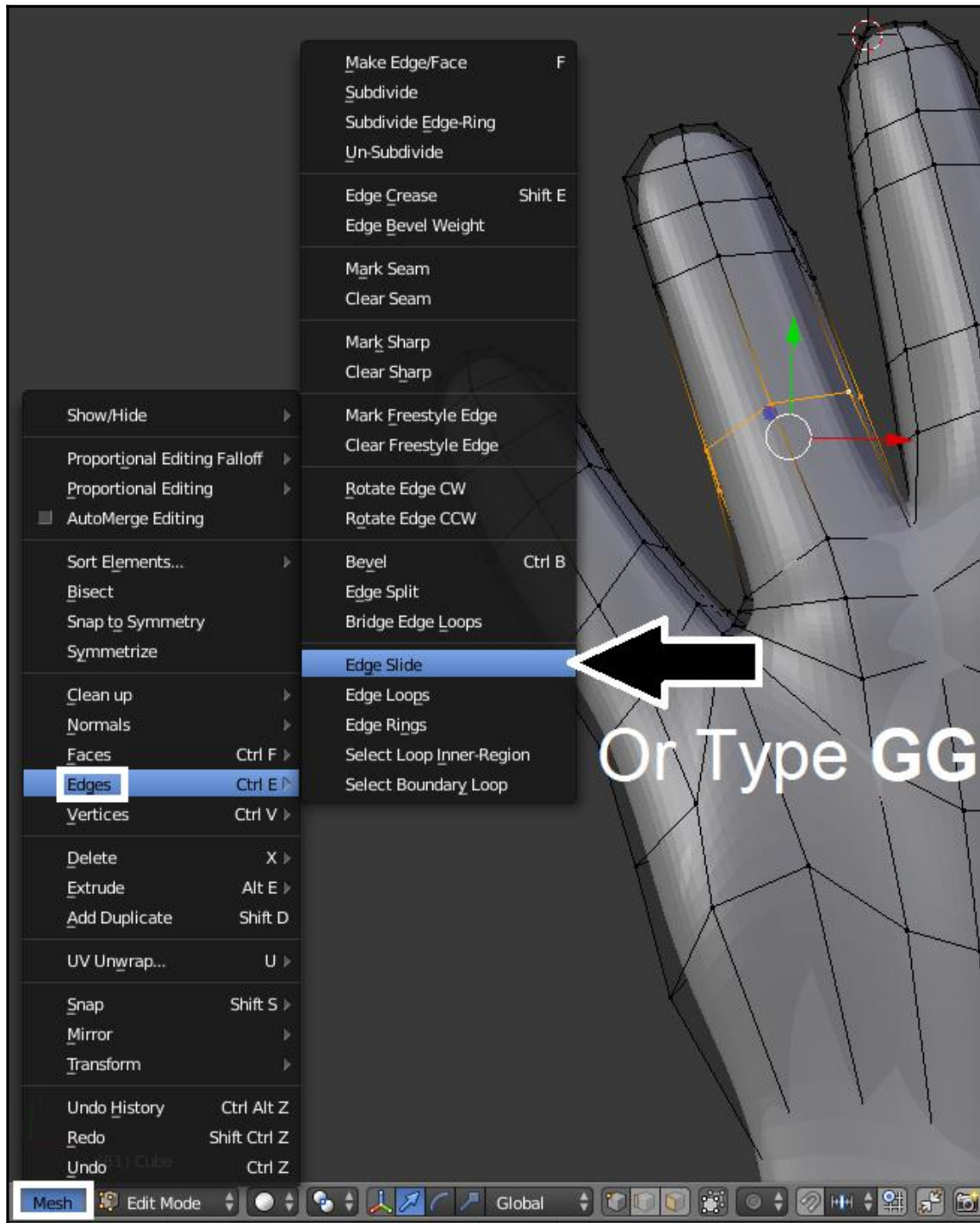

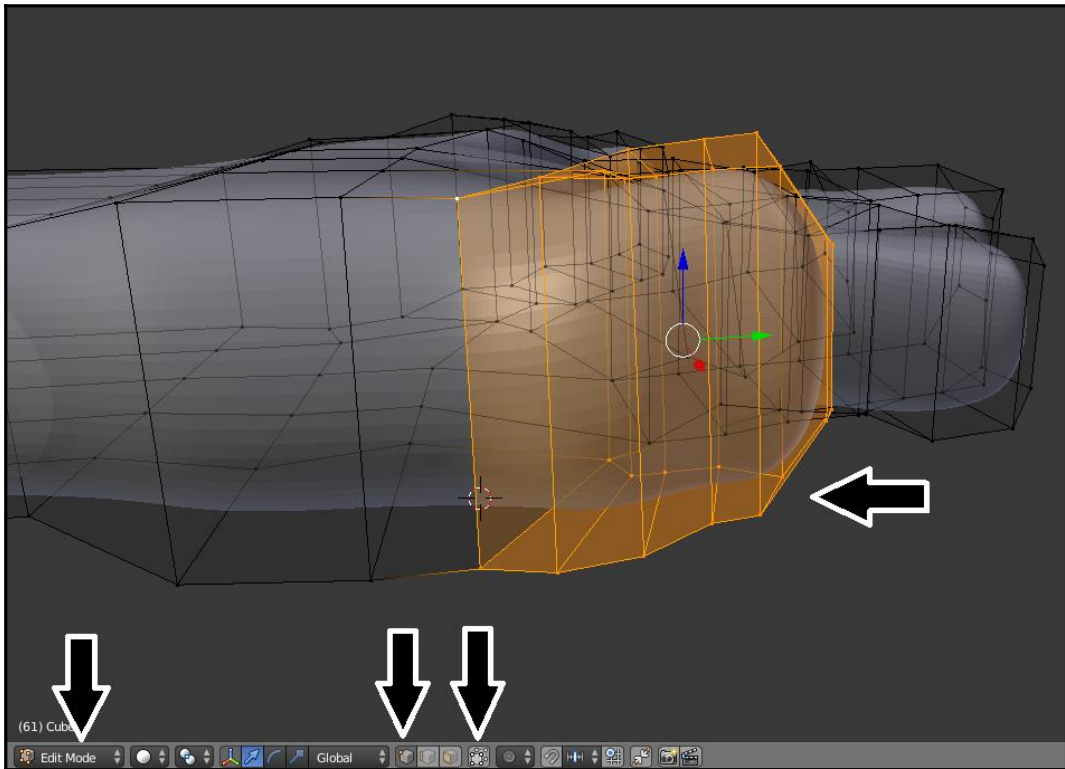
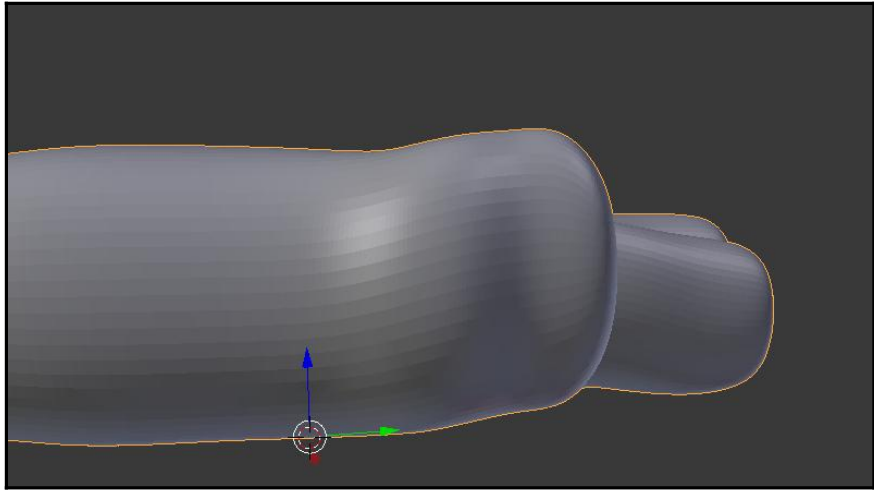

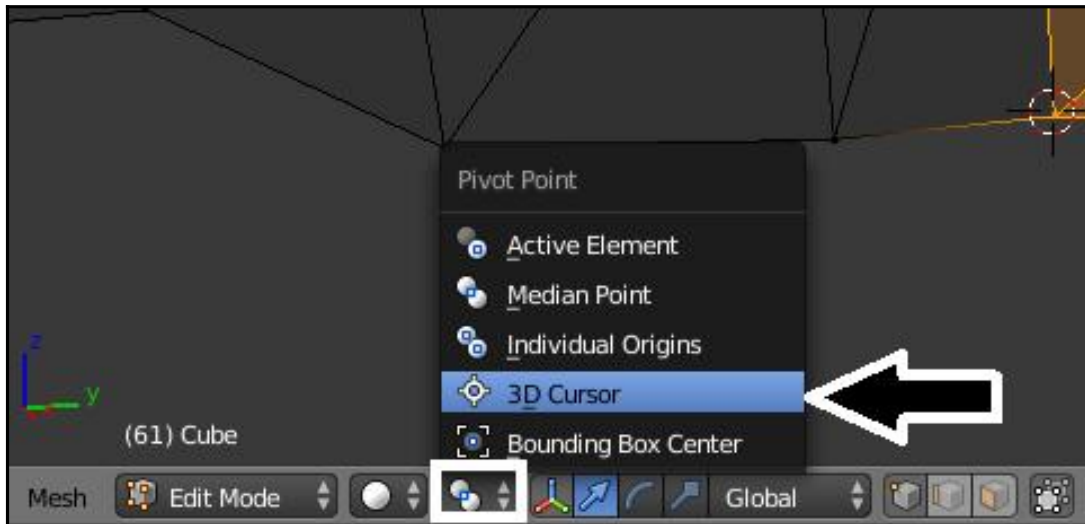
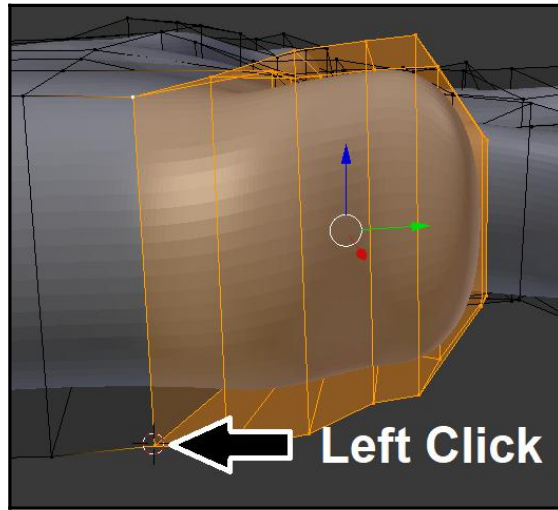

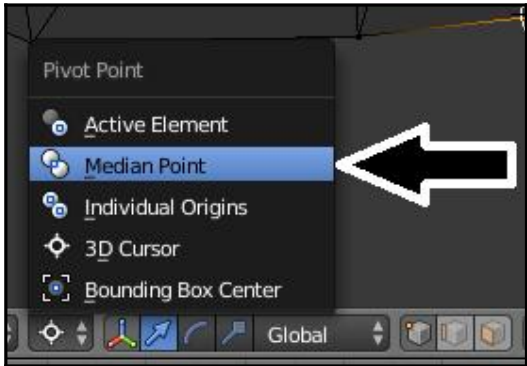
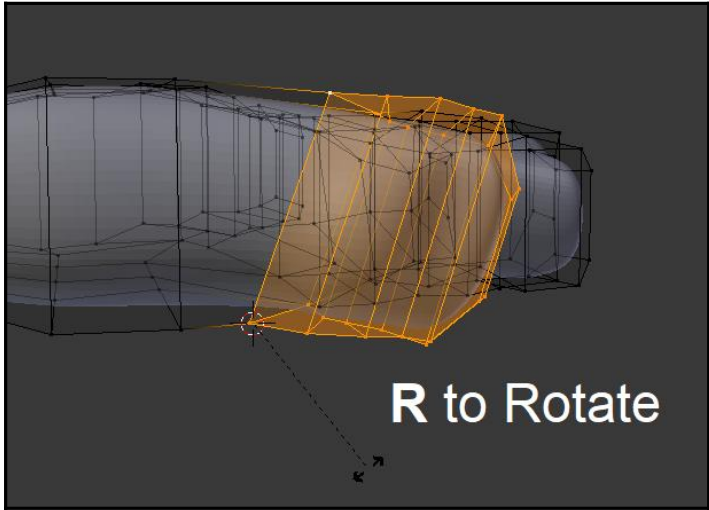



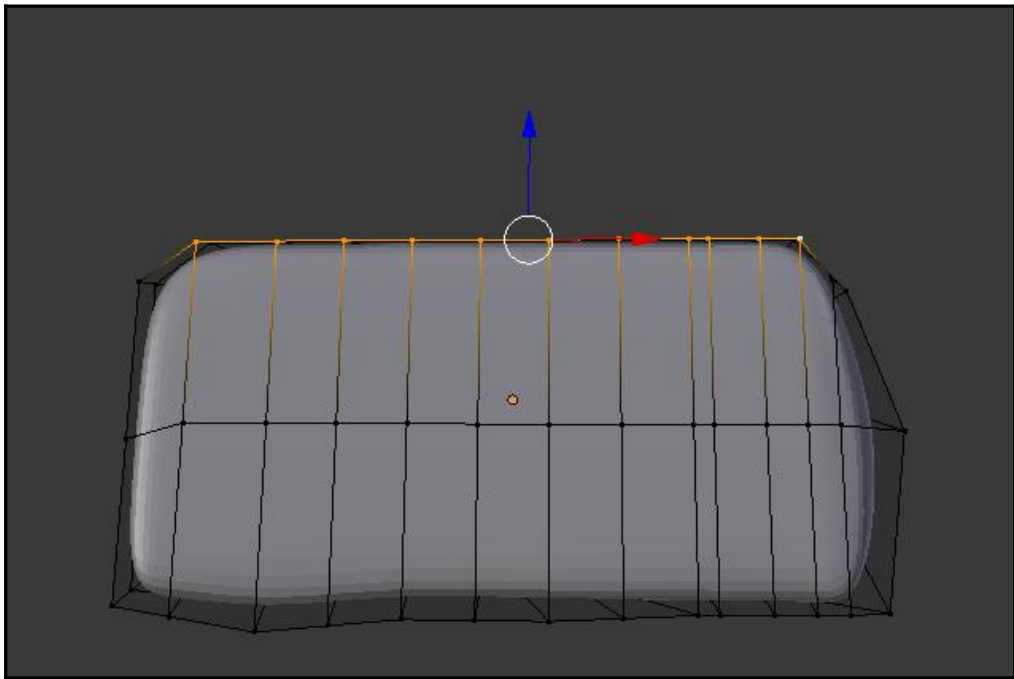
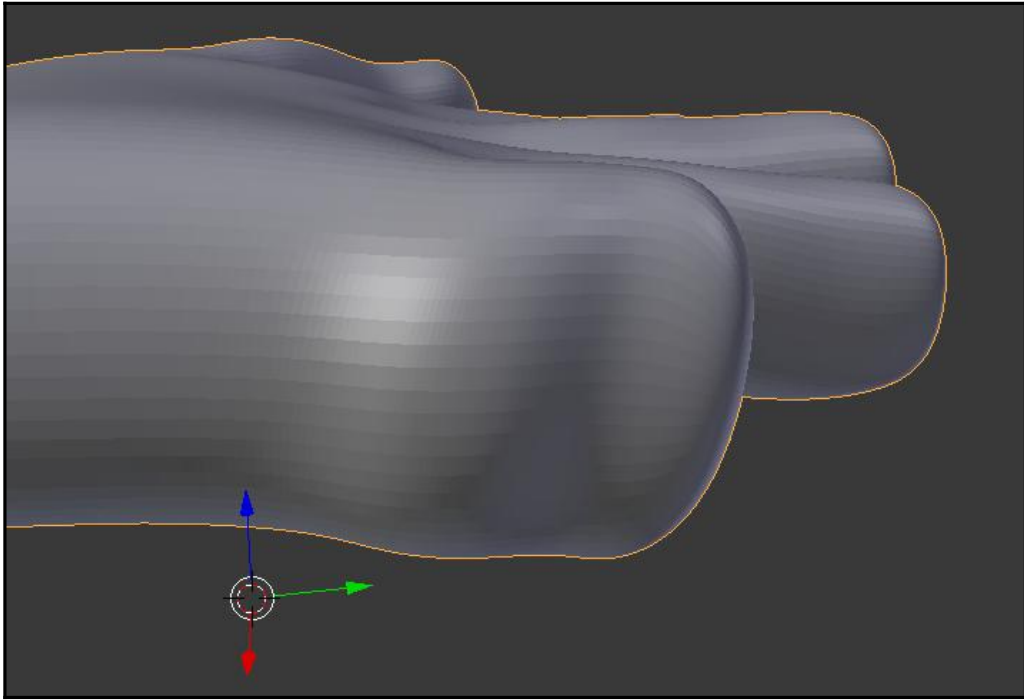

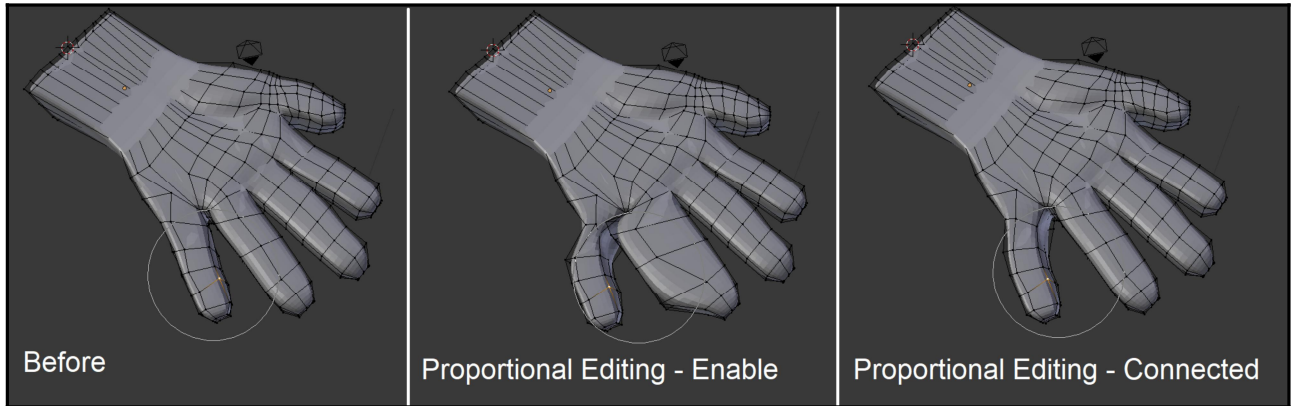
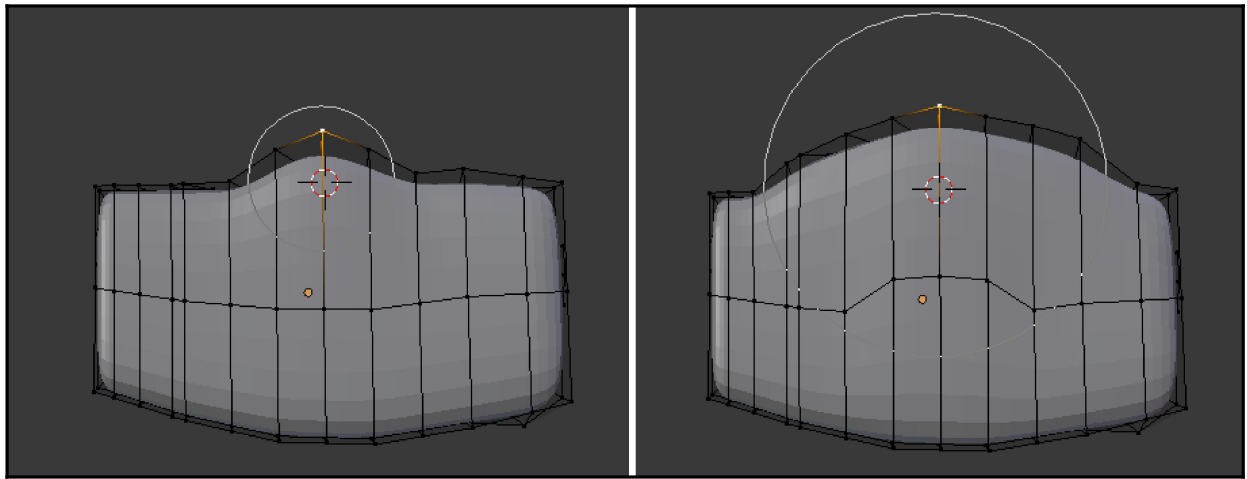
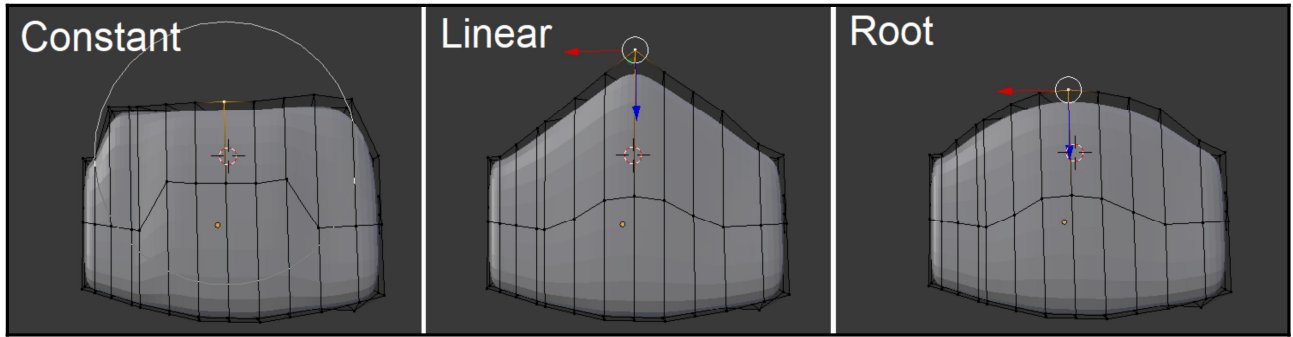

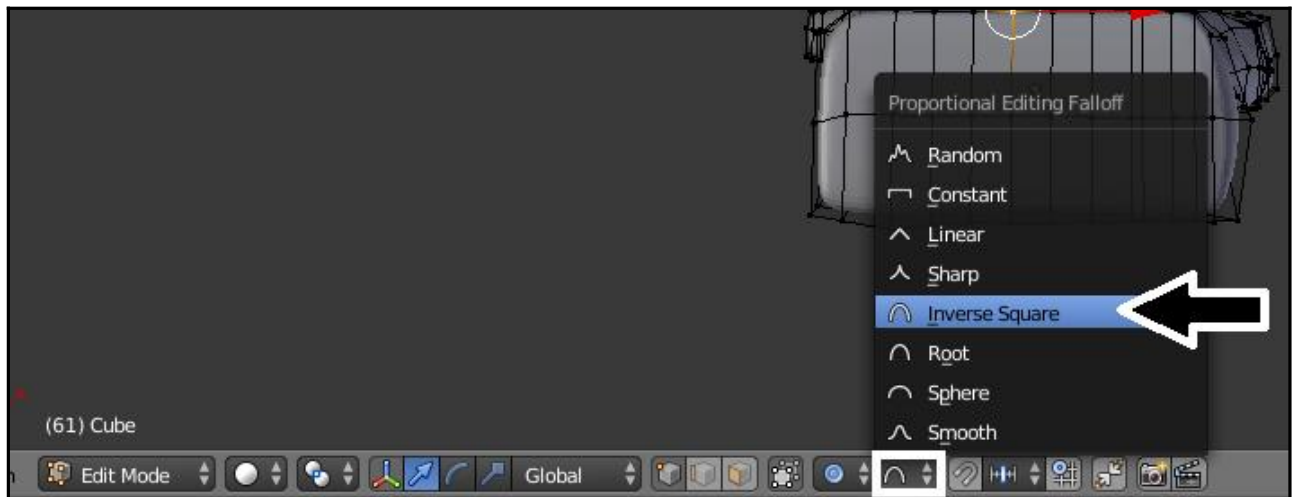
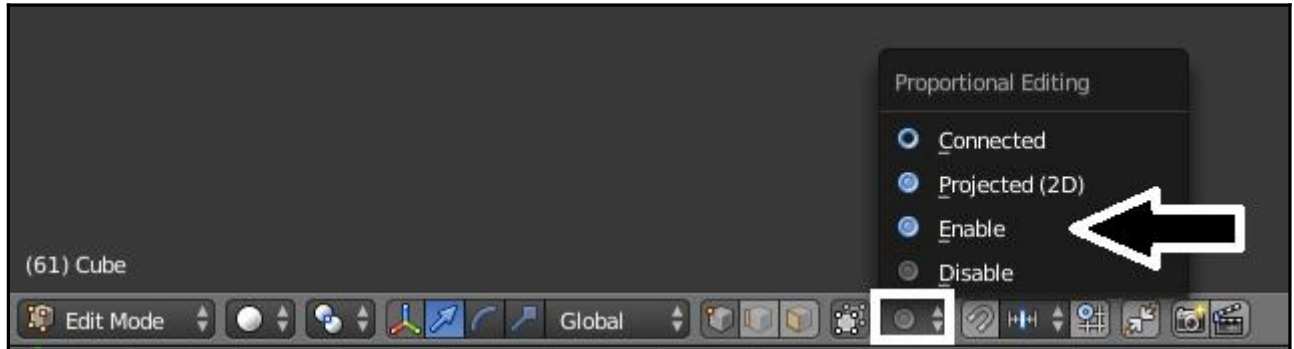
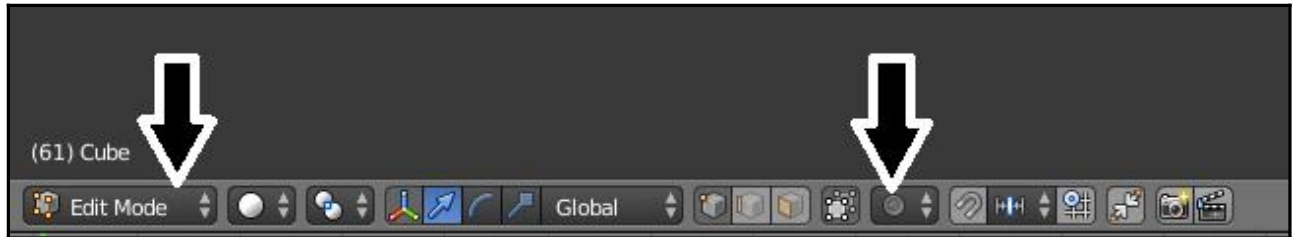

Mouse Scroll Wheel or  
Page Up/Page Down

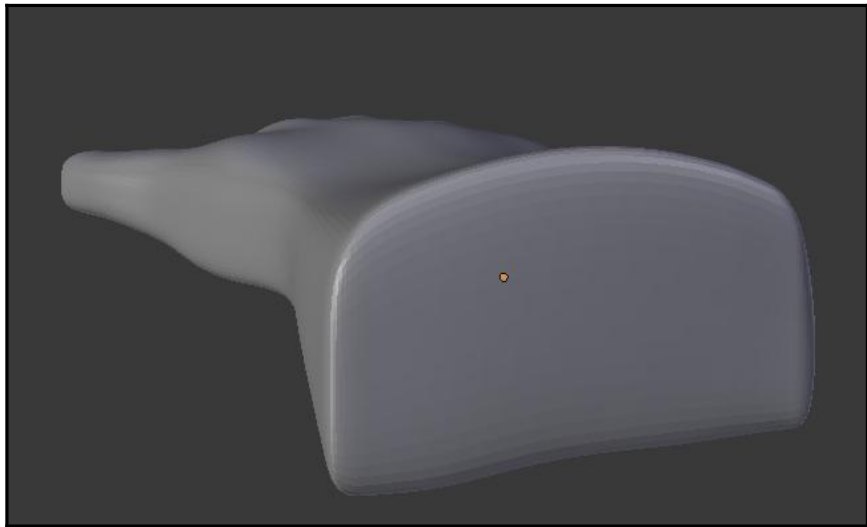
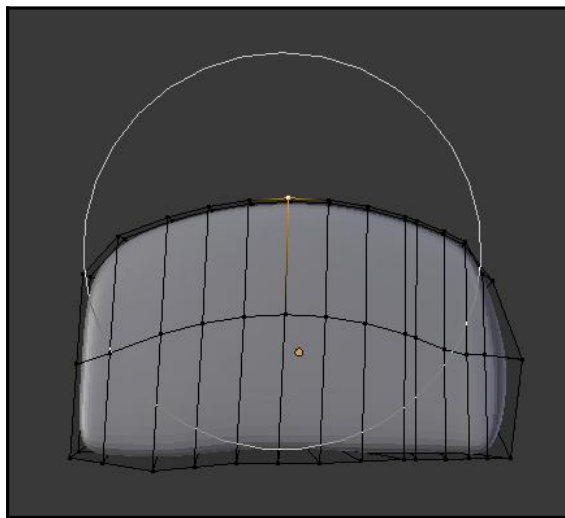
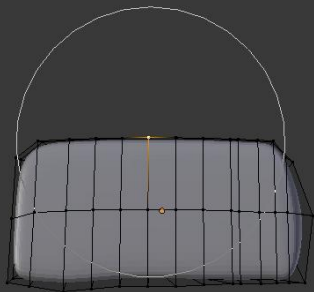

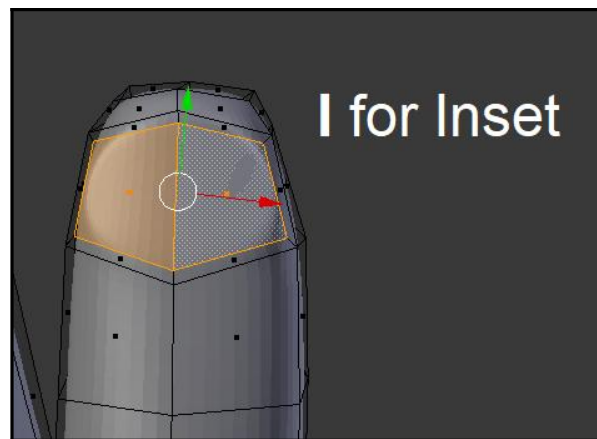
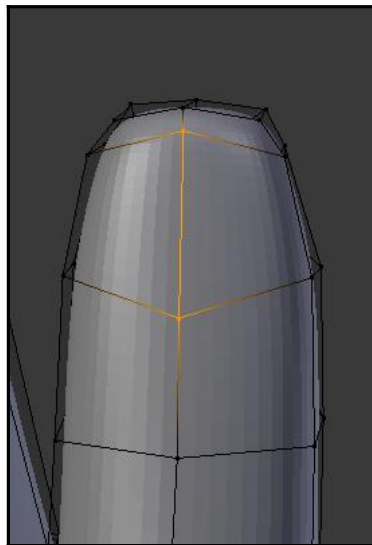
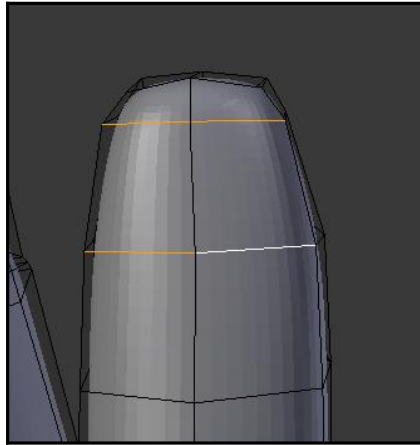

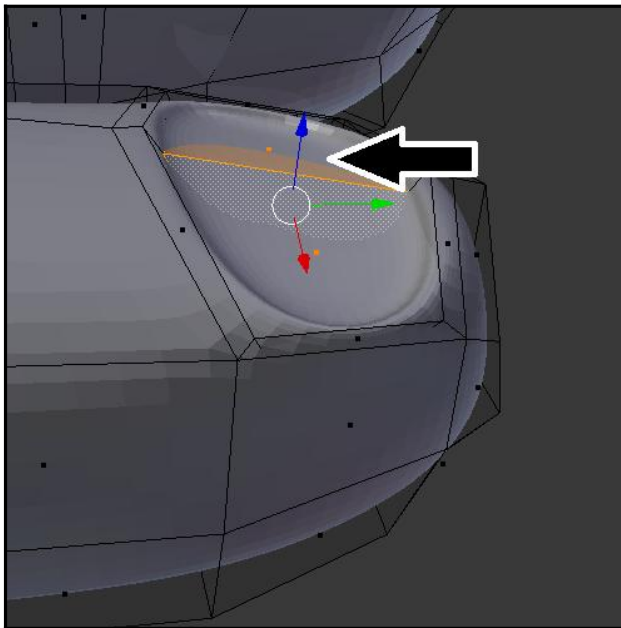
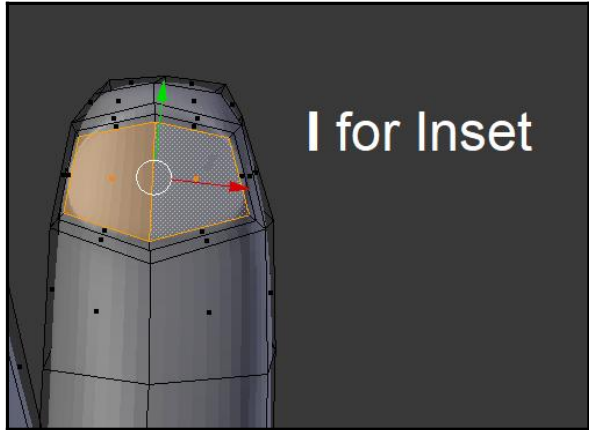

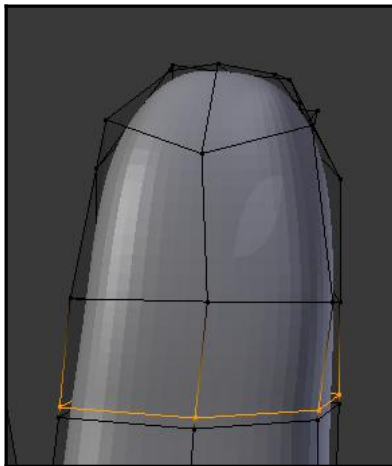
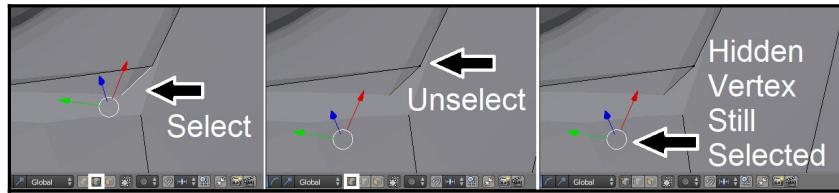
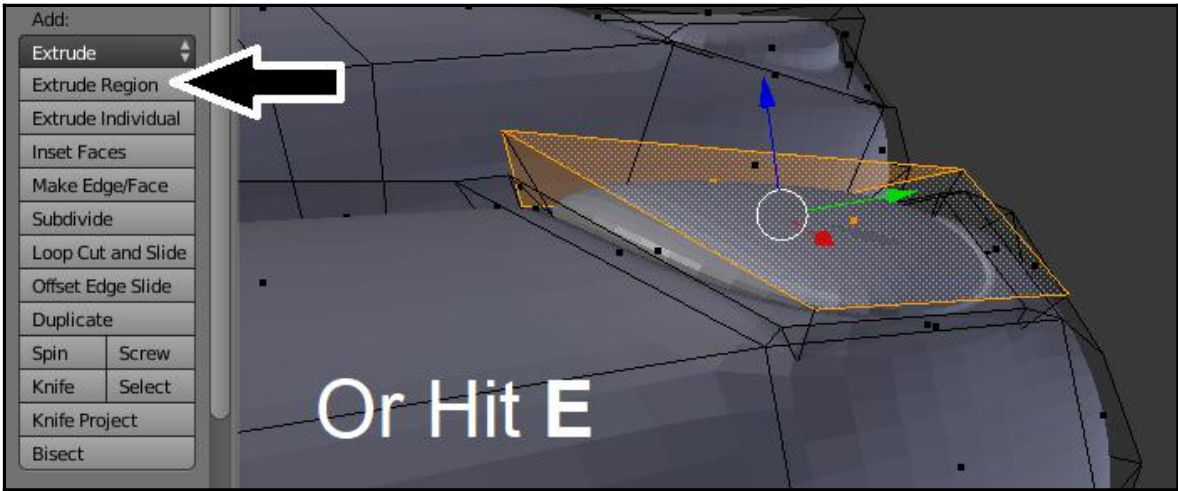

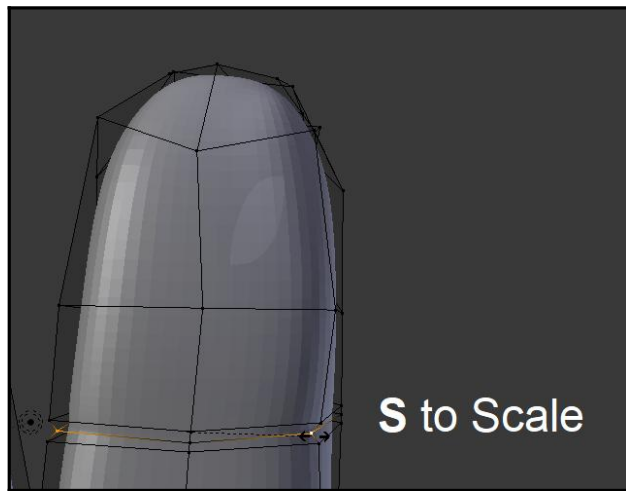
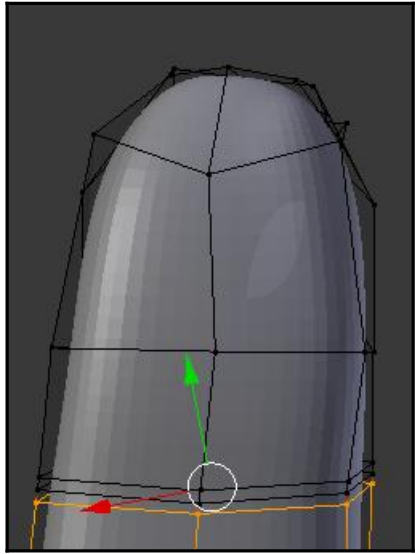





# Chapter 14: Coloring Models with Materials and UV Maps

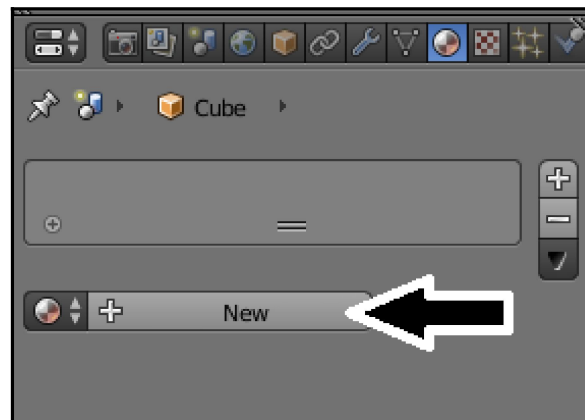
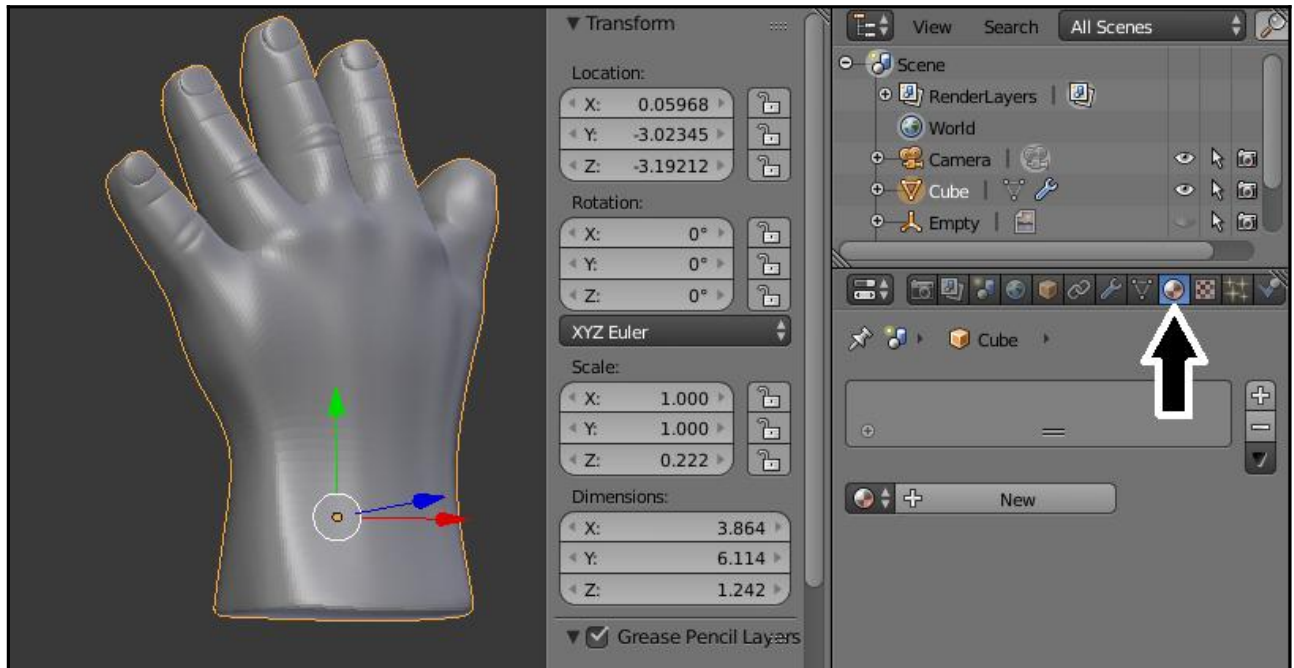

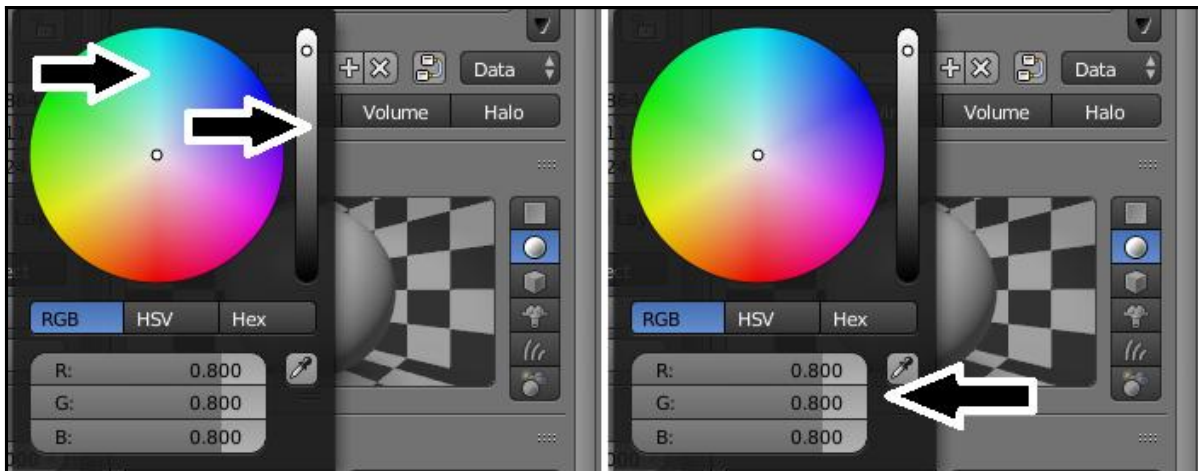
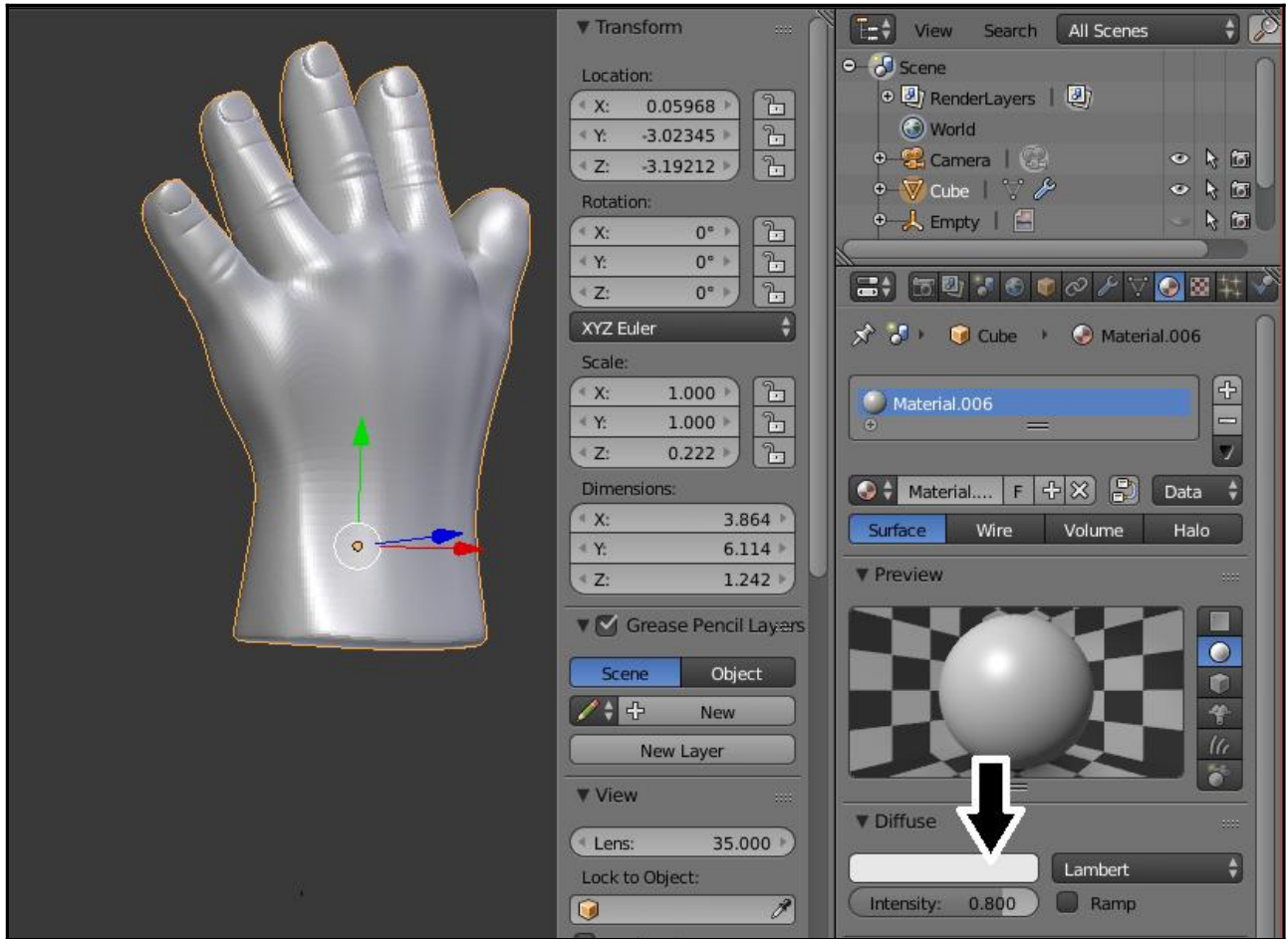

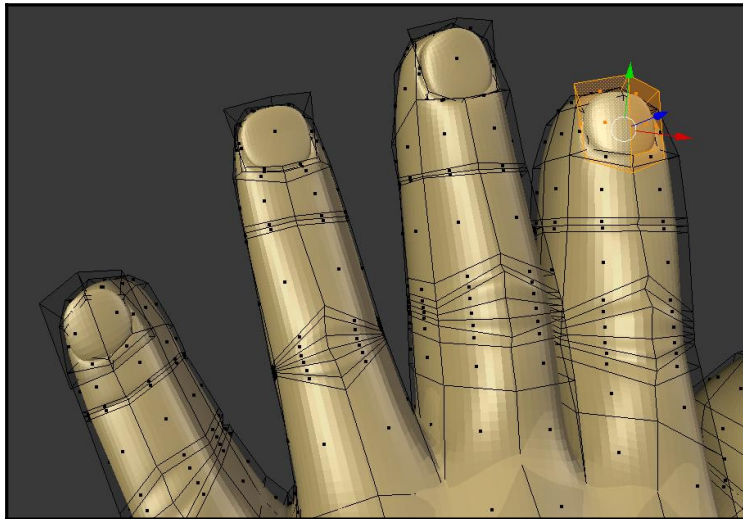
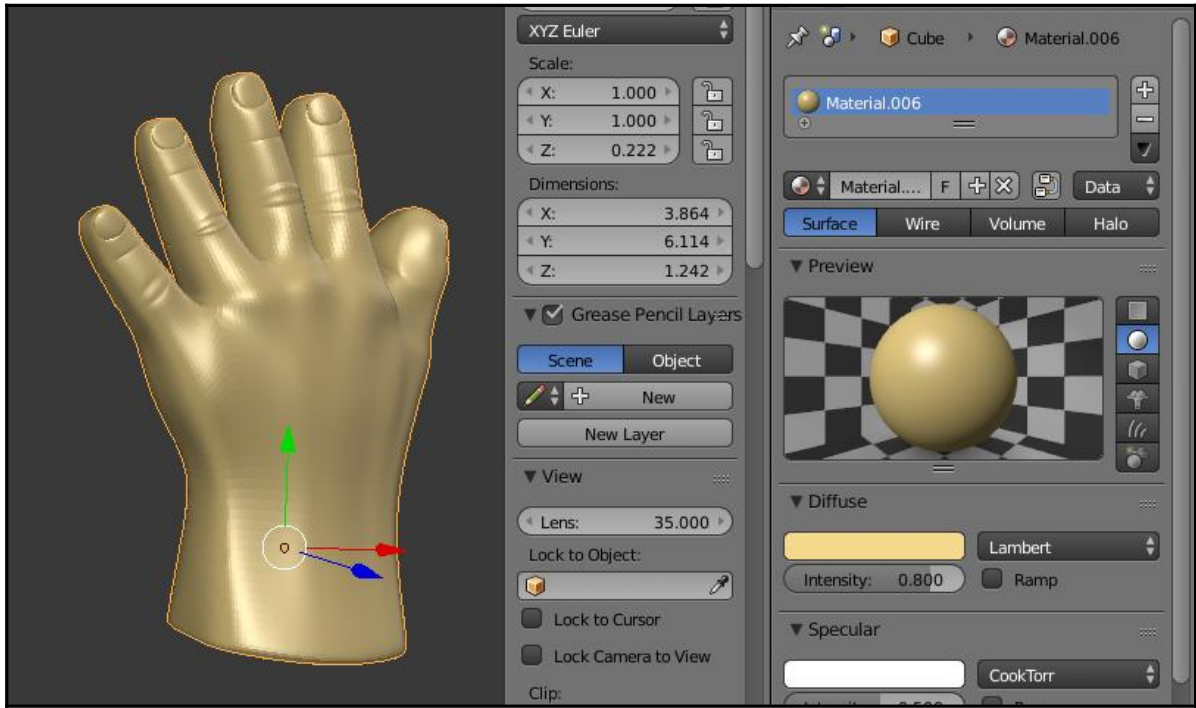

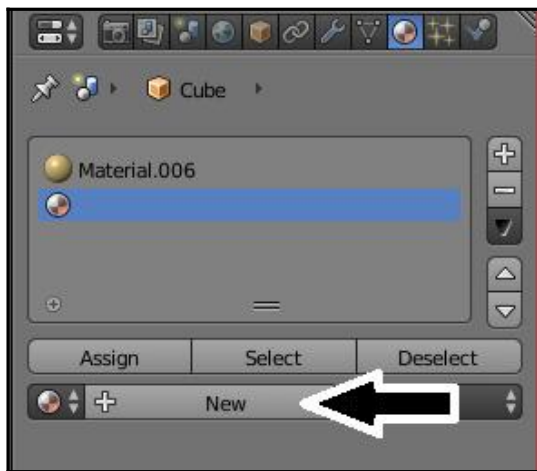
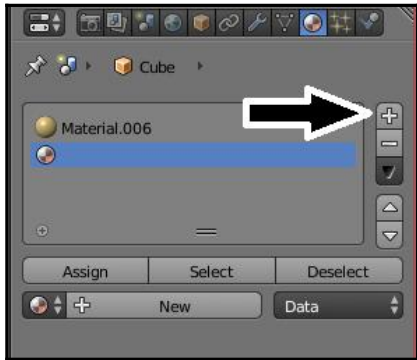

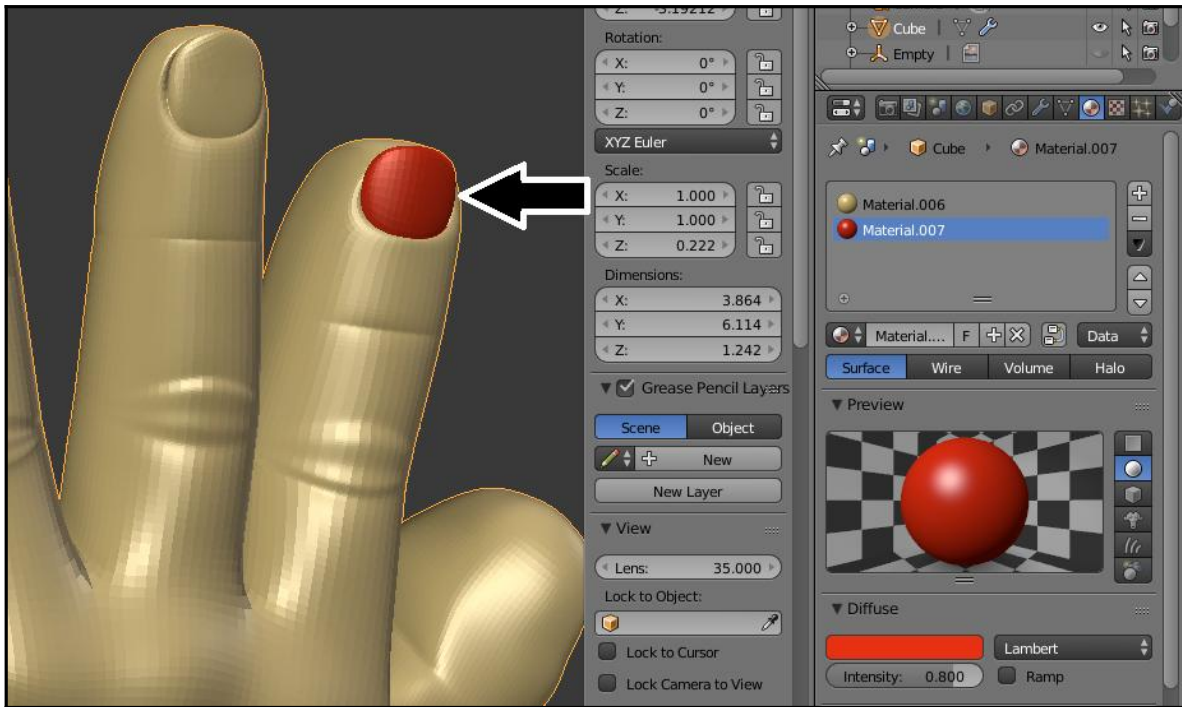
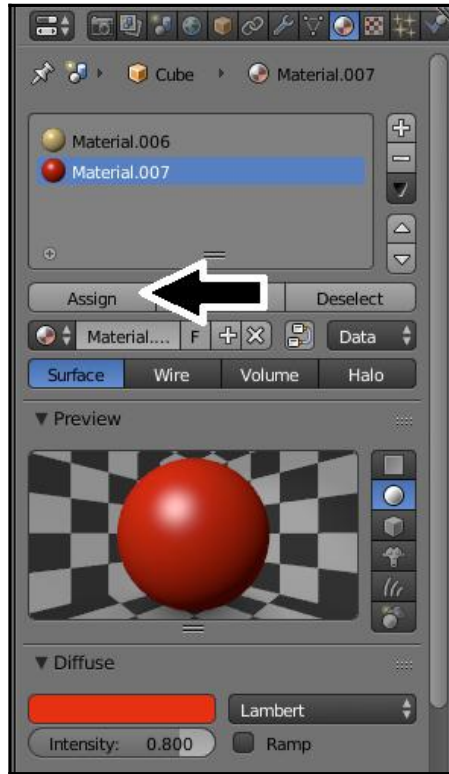

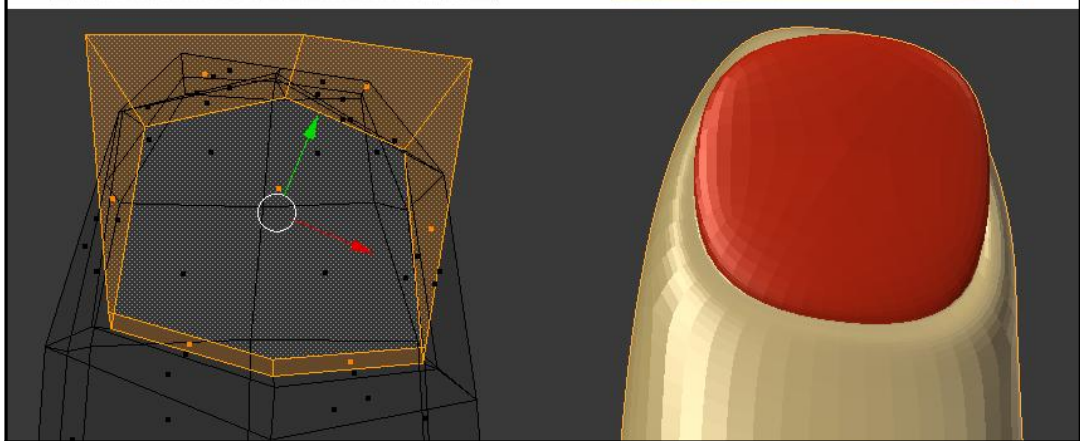
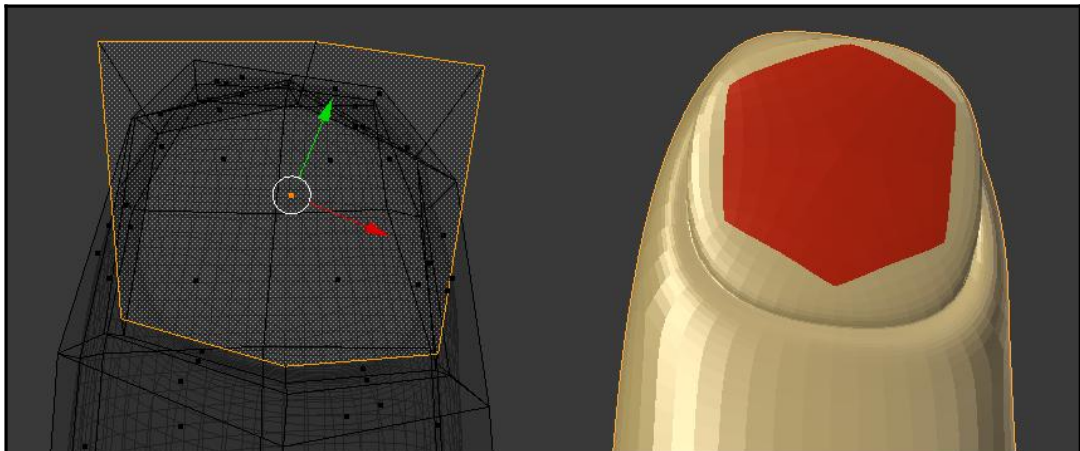
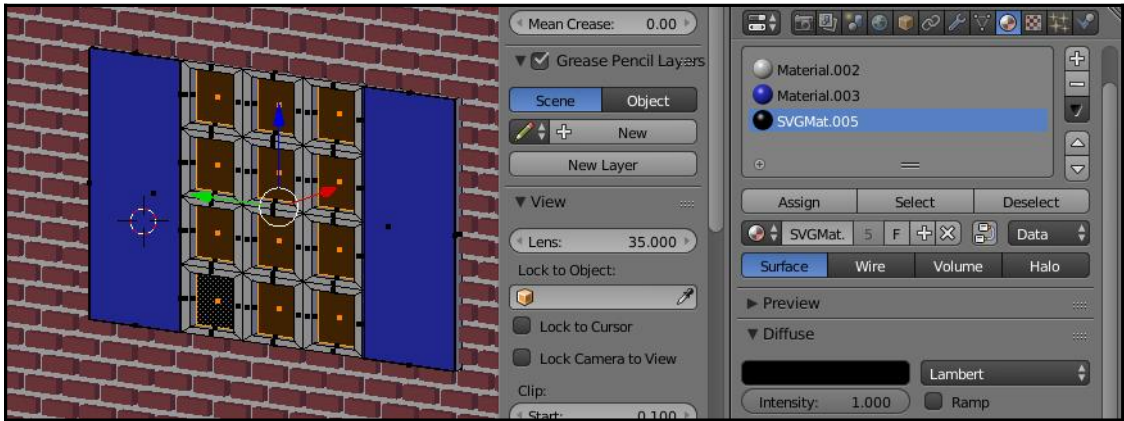

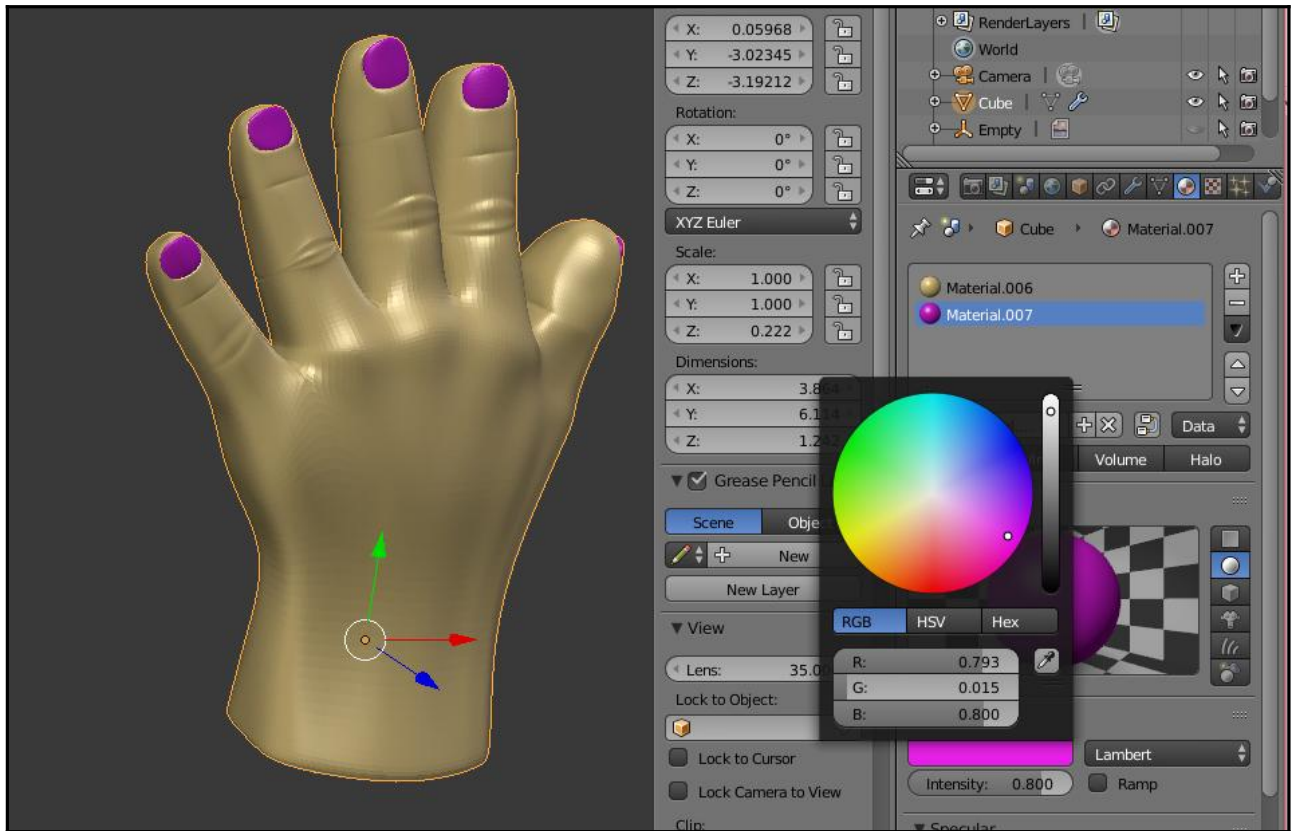
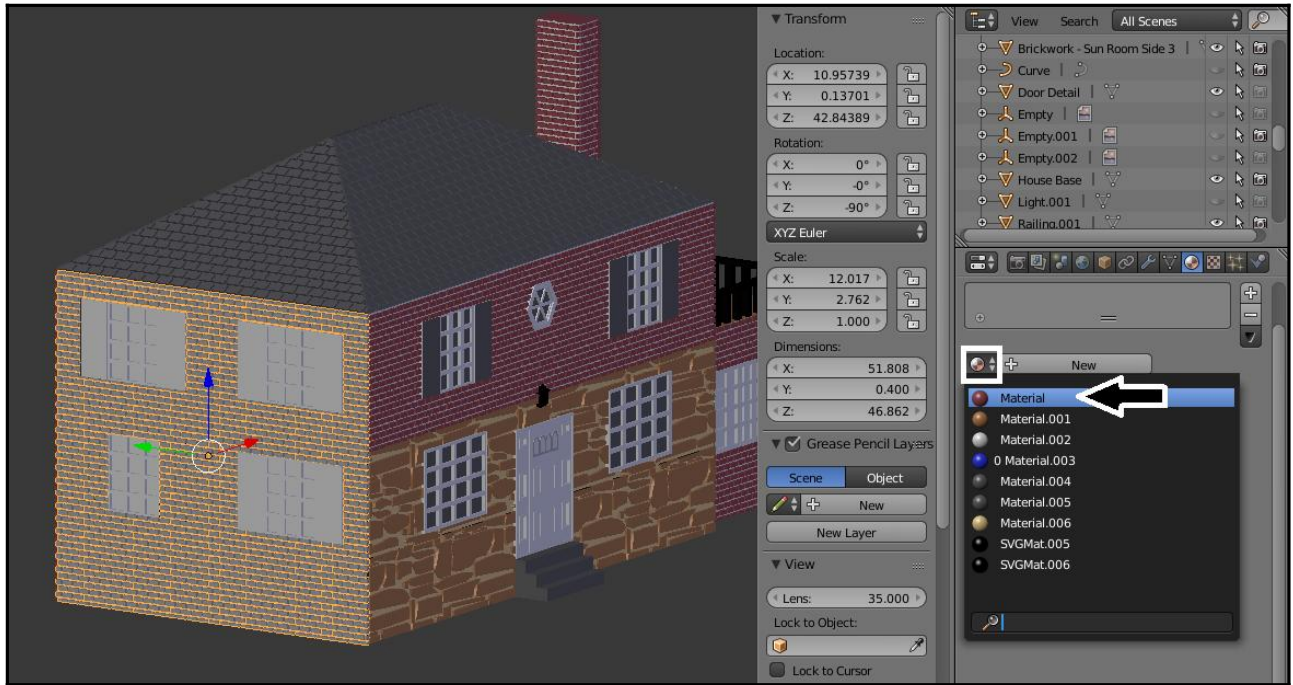



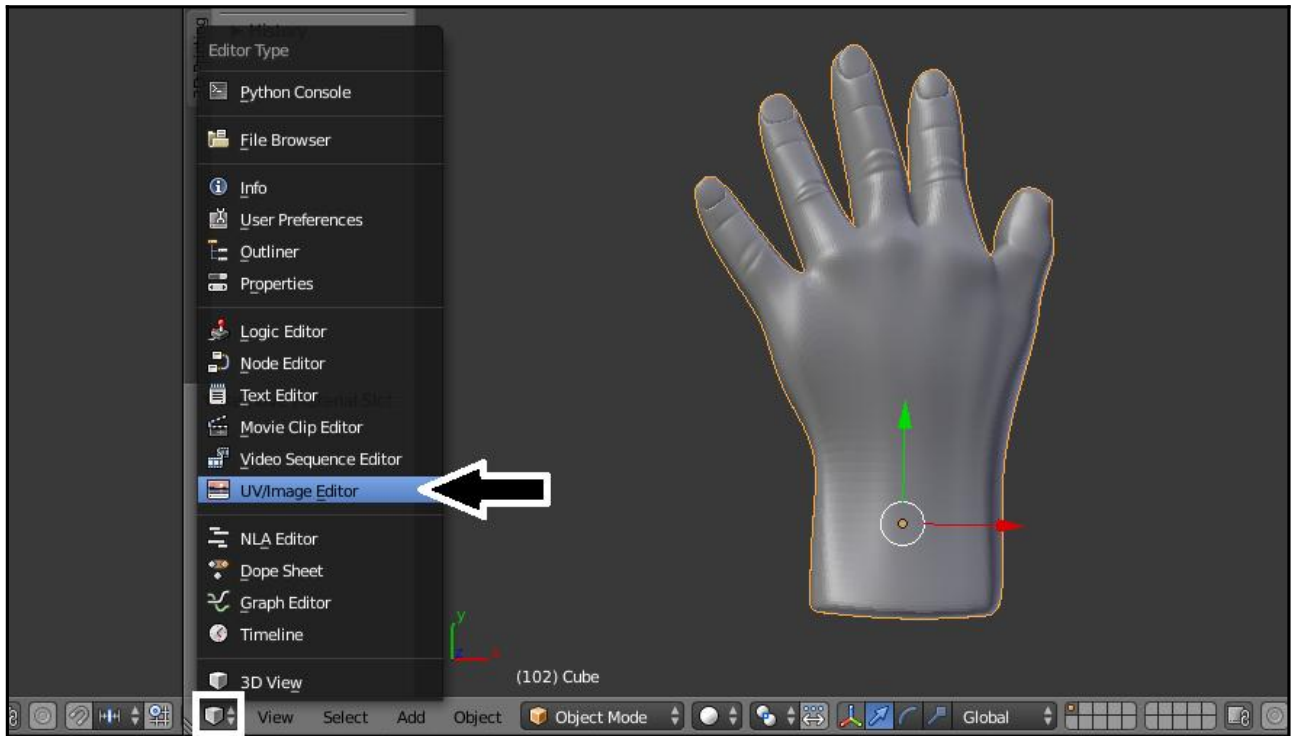
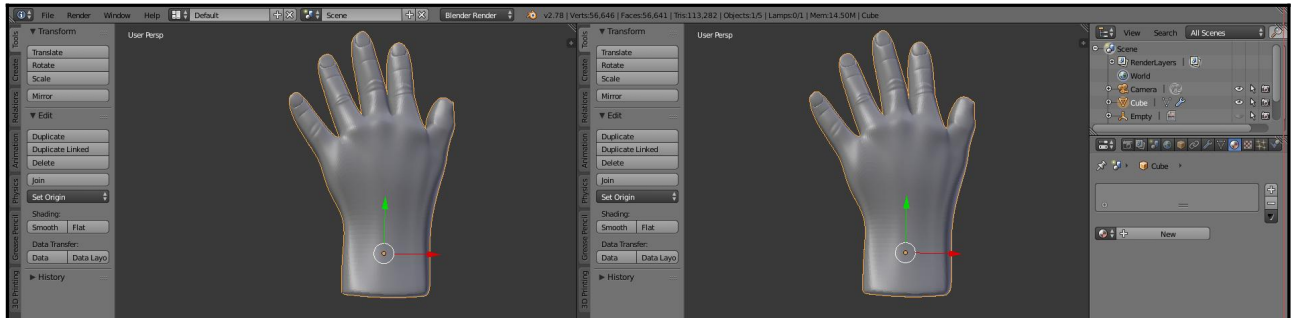
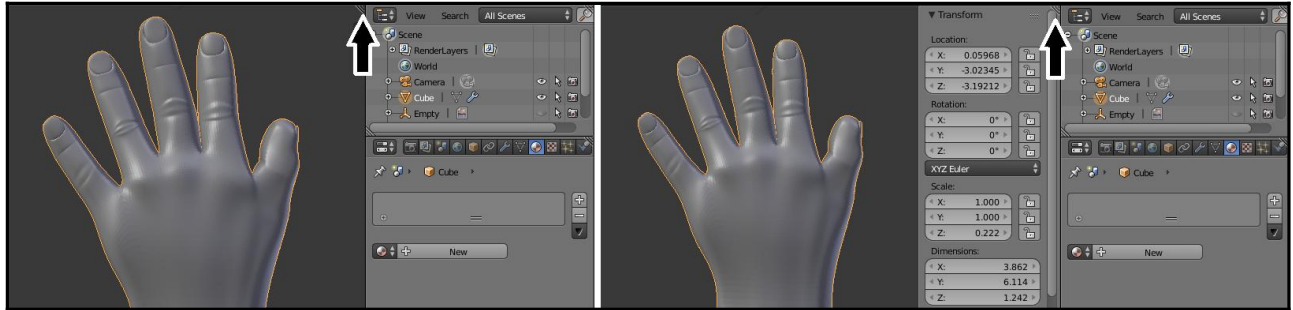

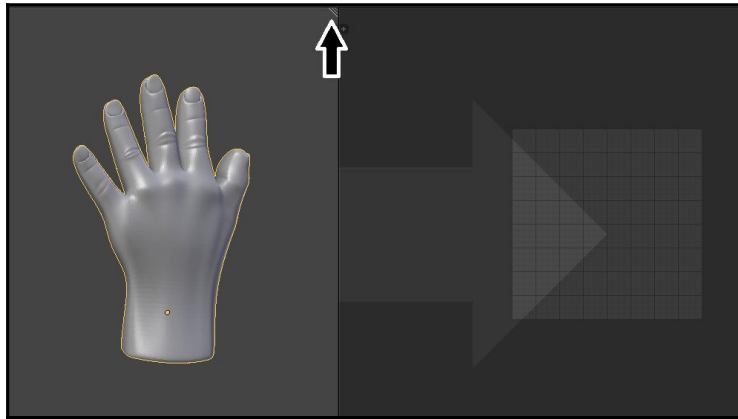
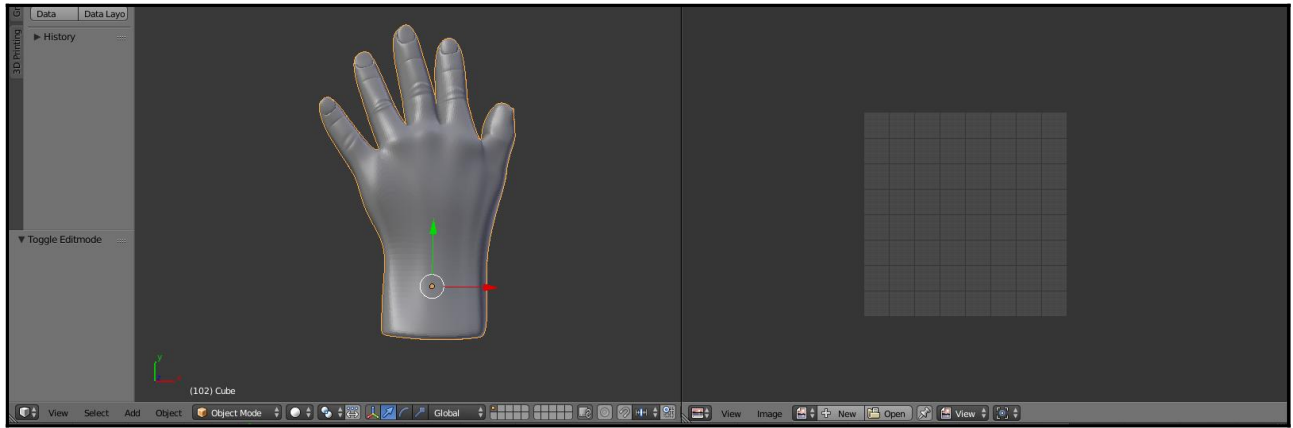

# A for Select All

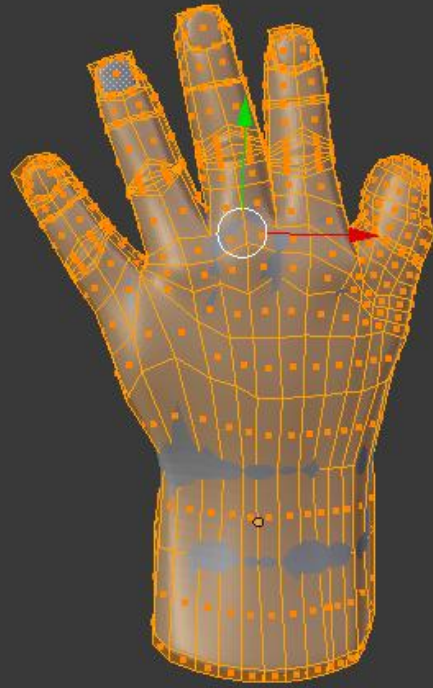

(102) Cube

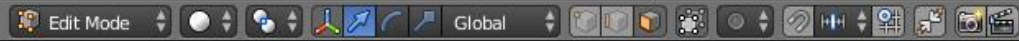

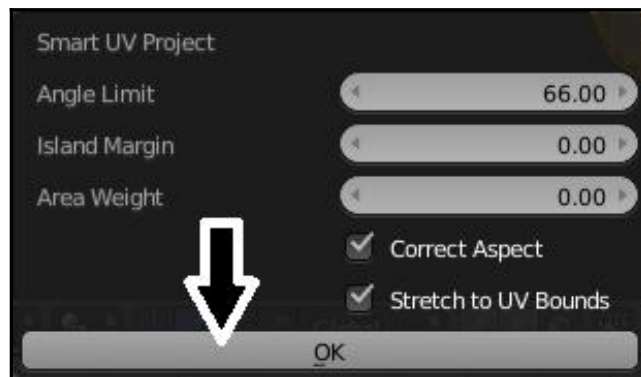
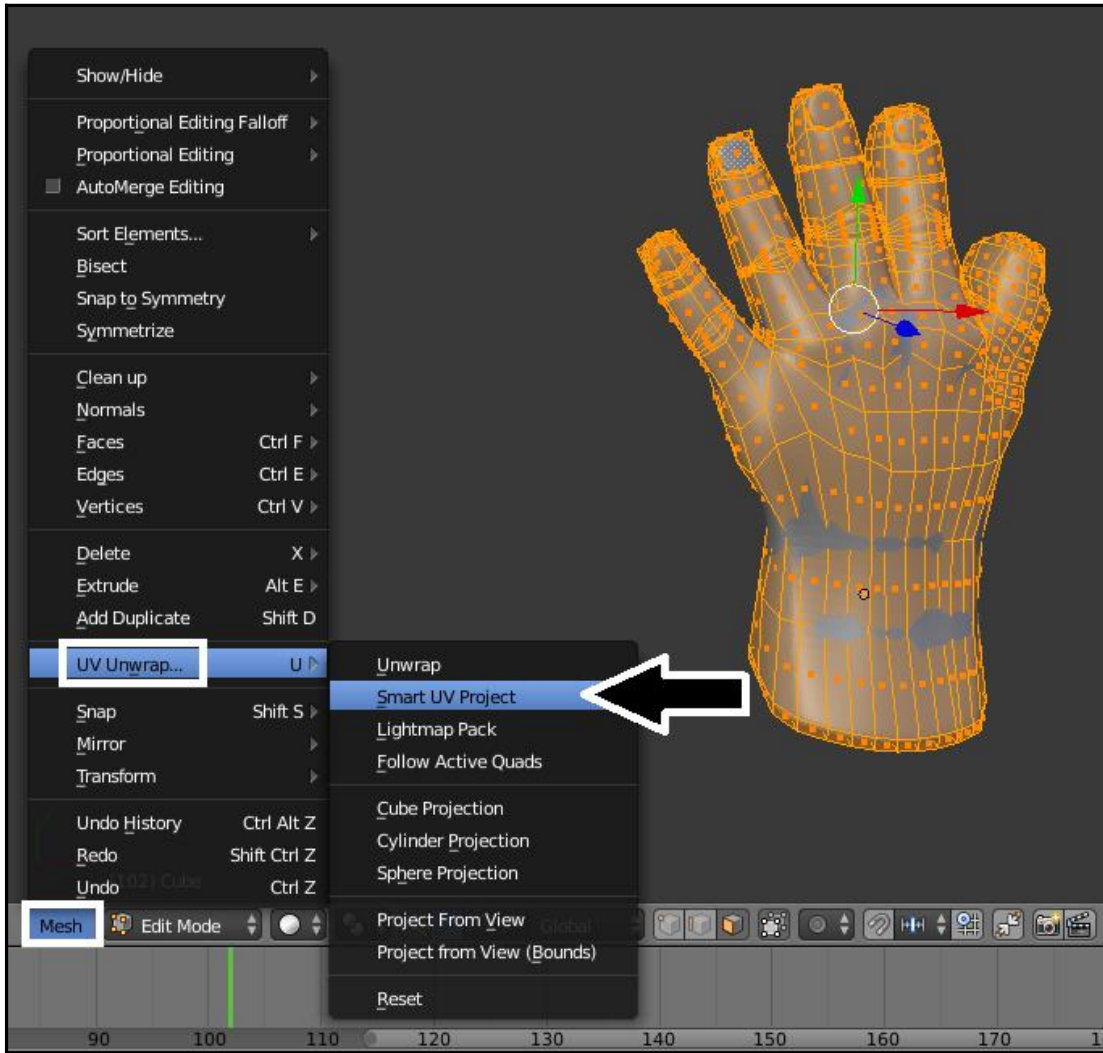

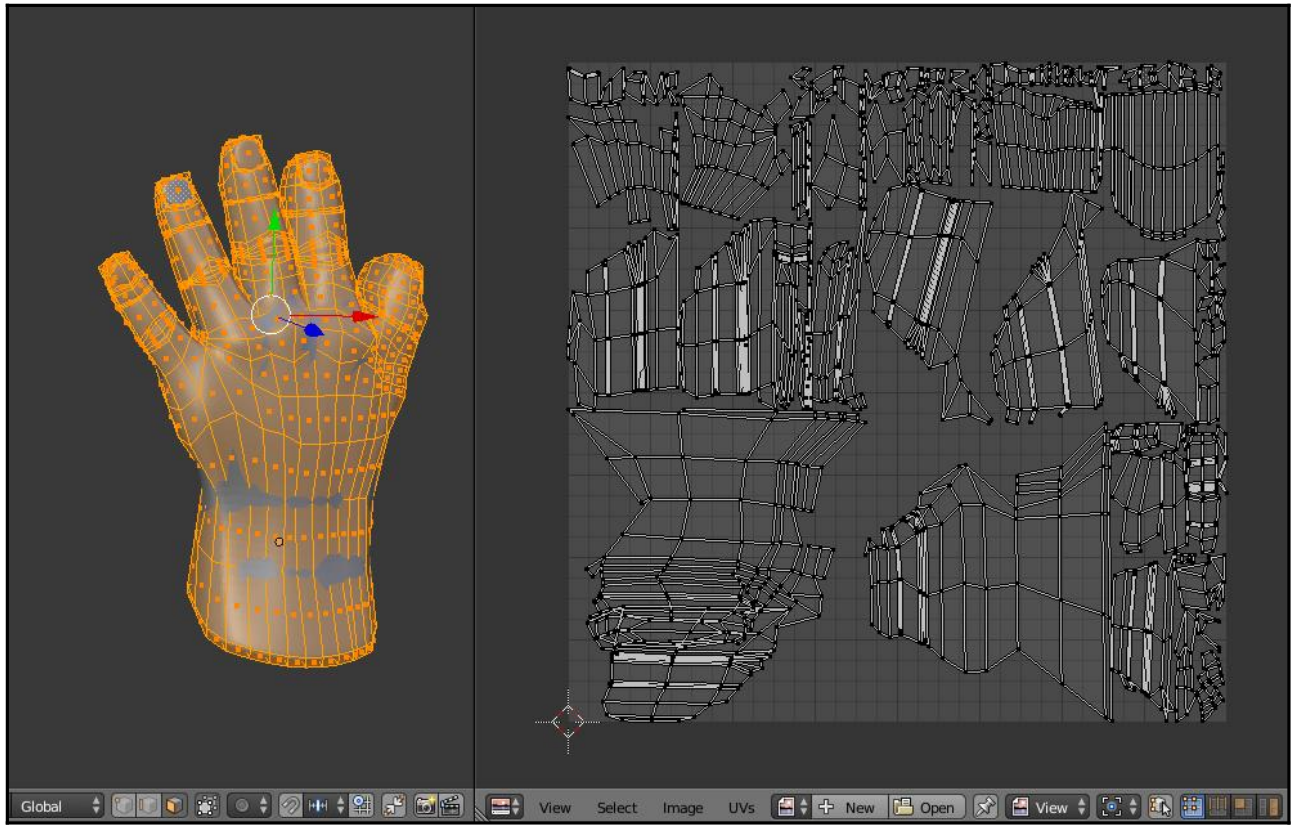

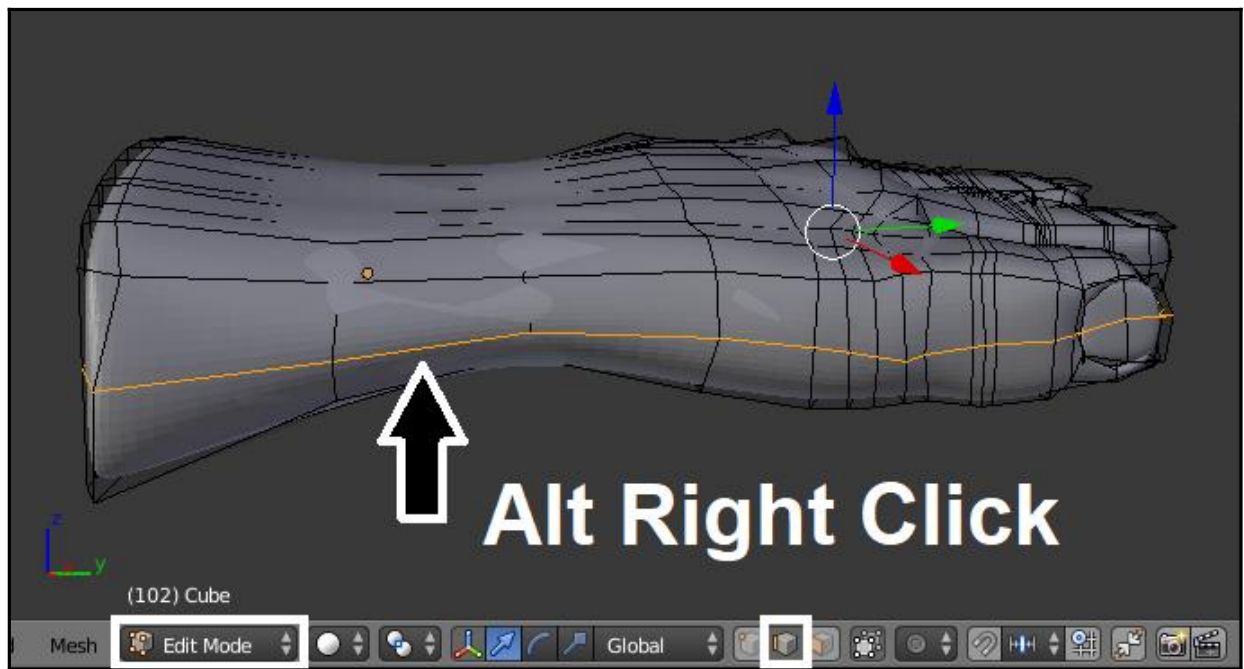
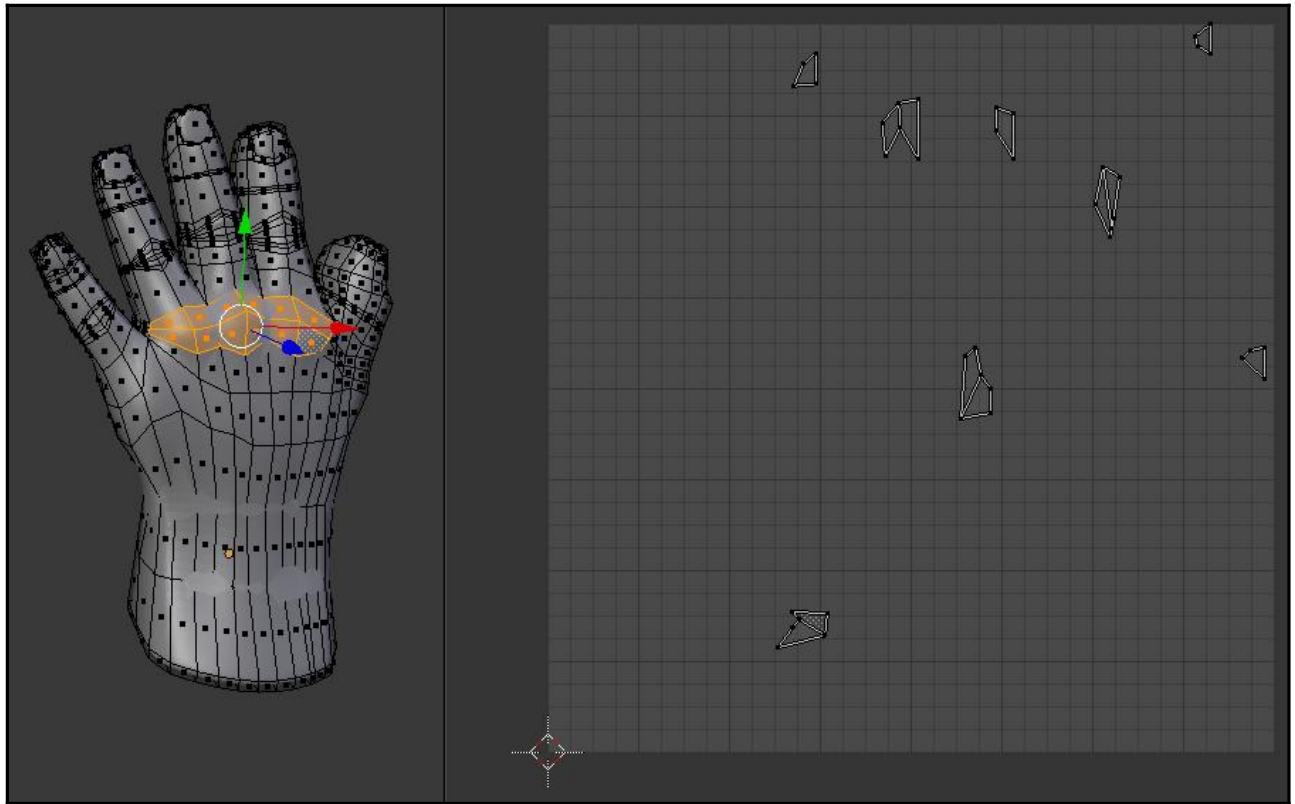

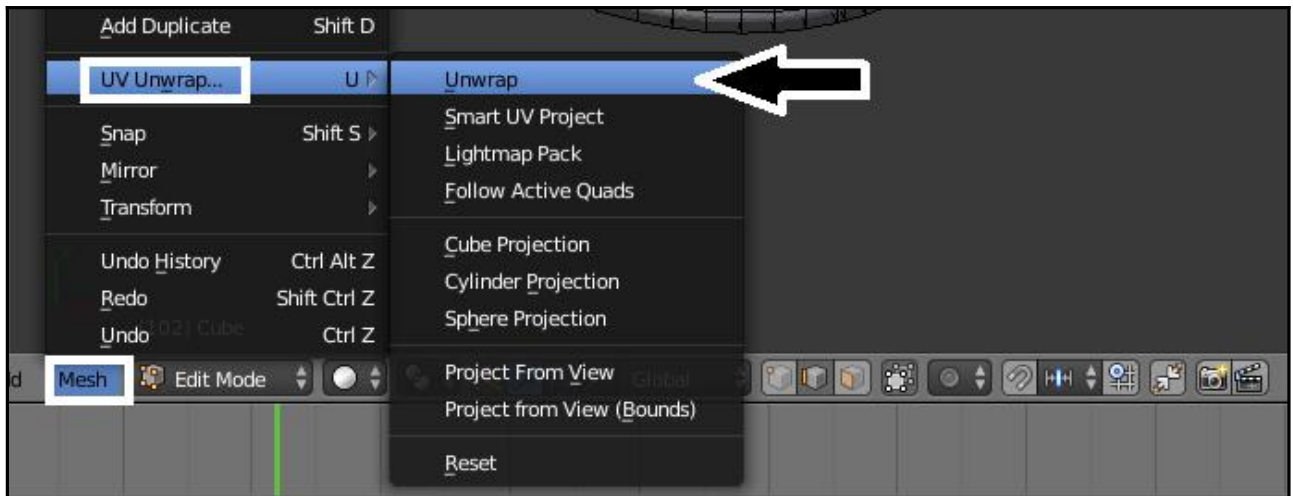
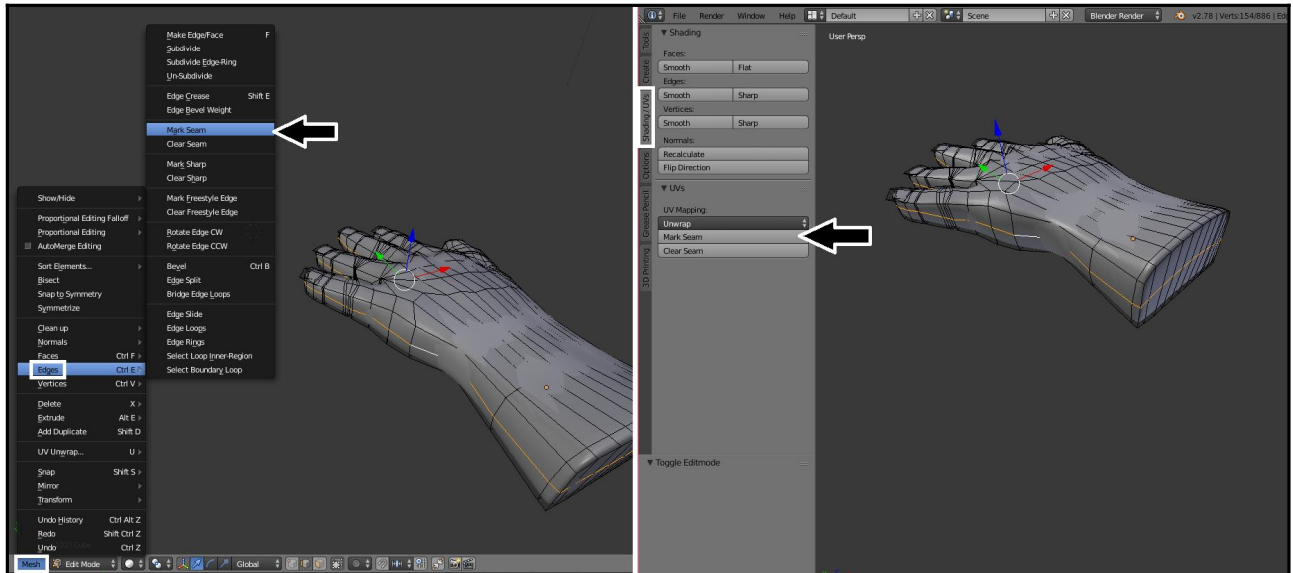

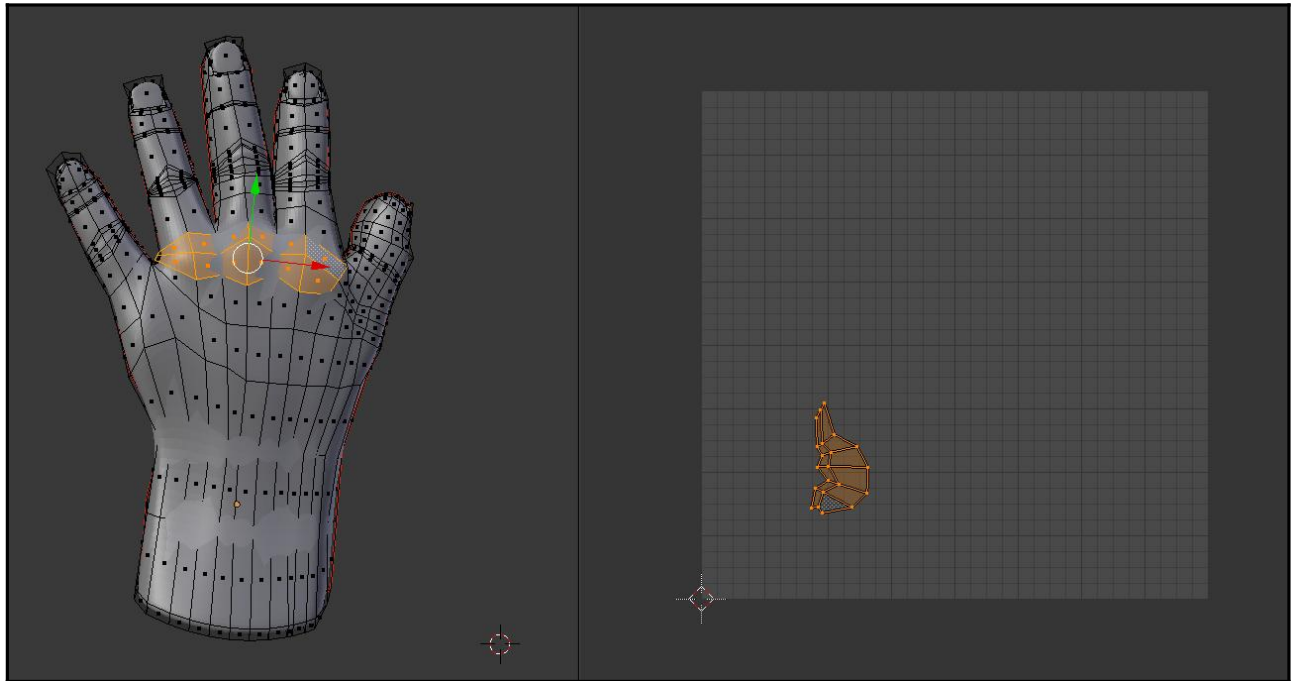
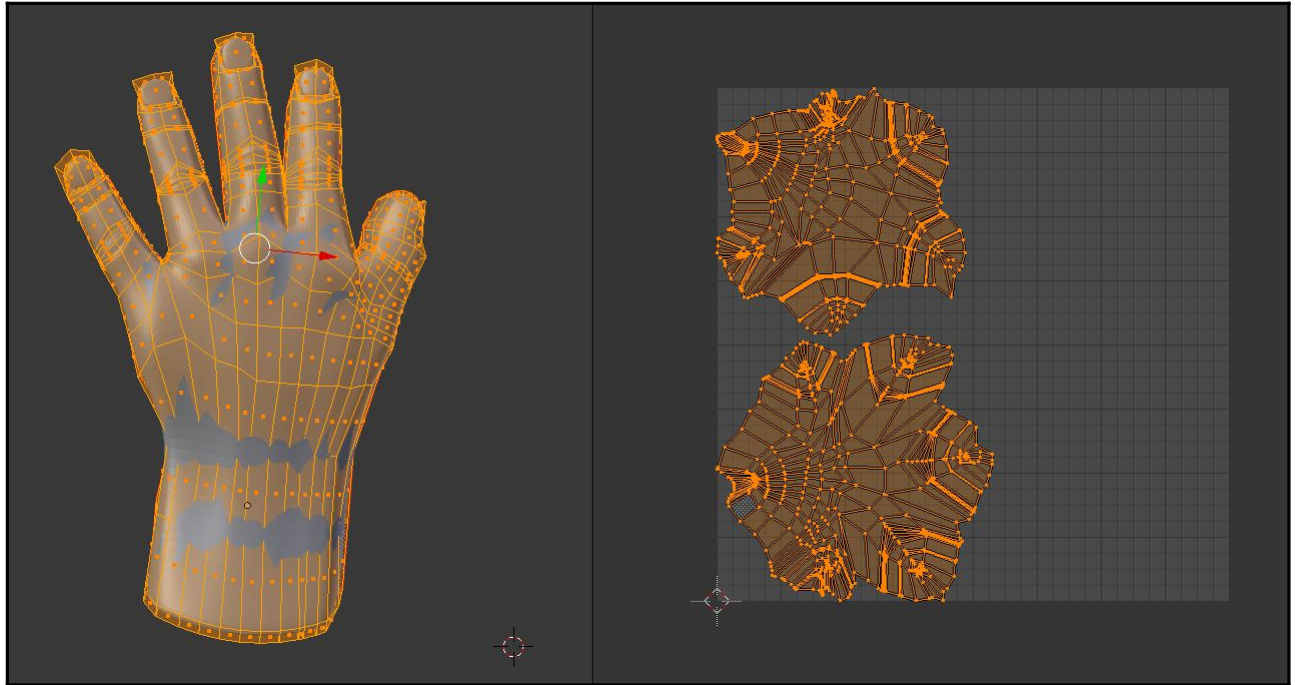



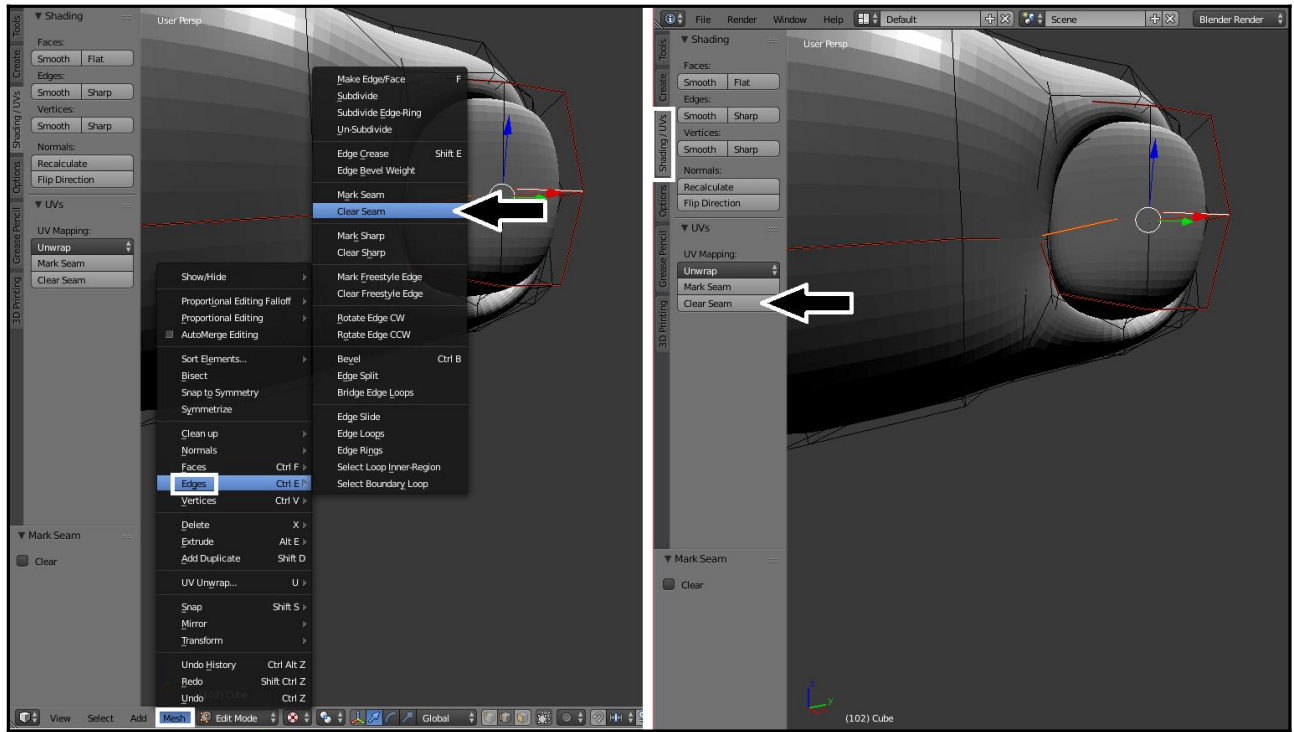
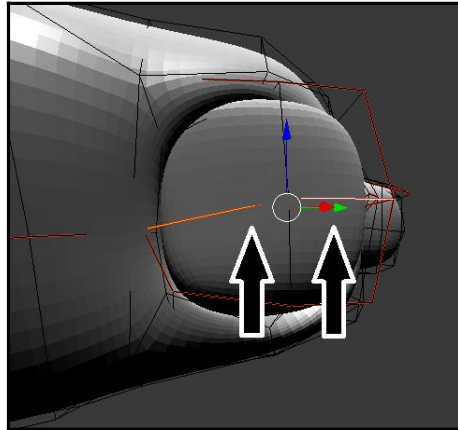

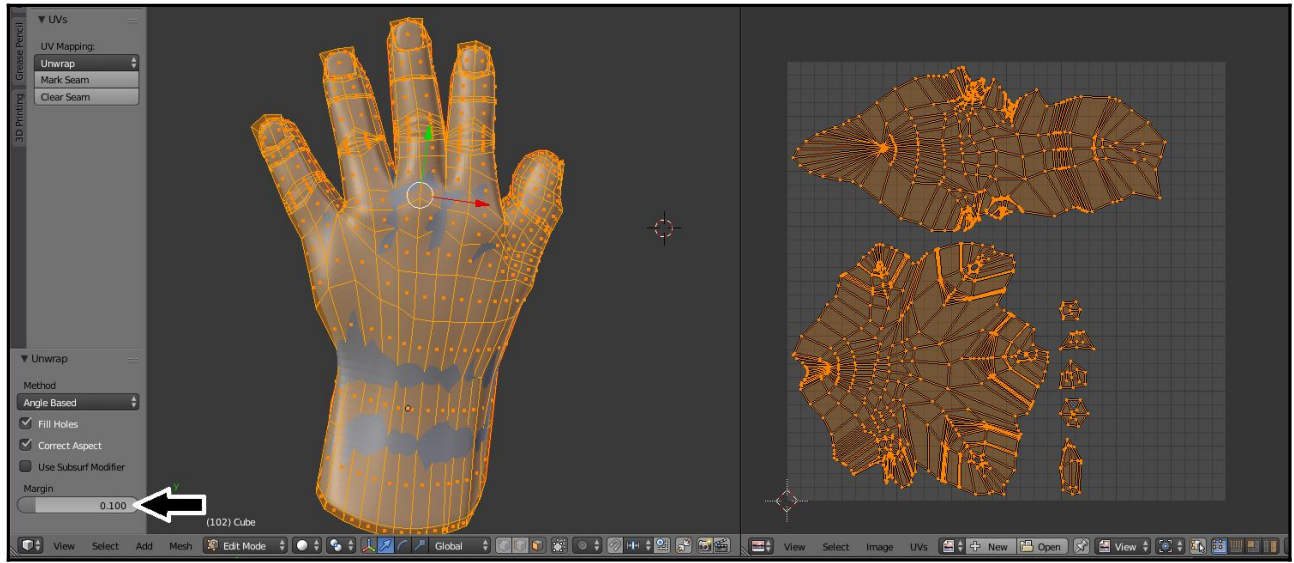

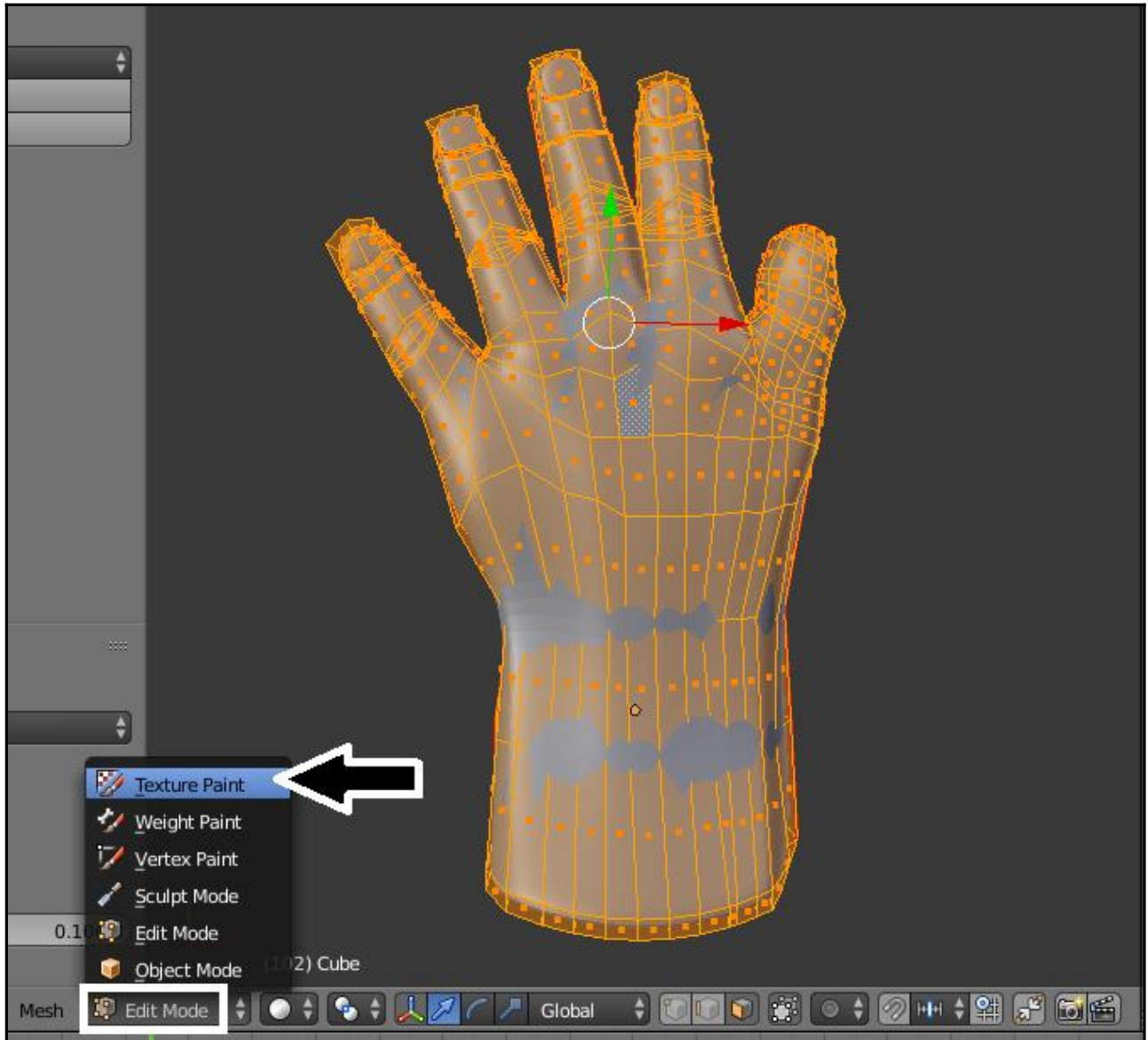

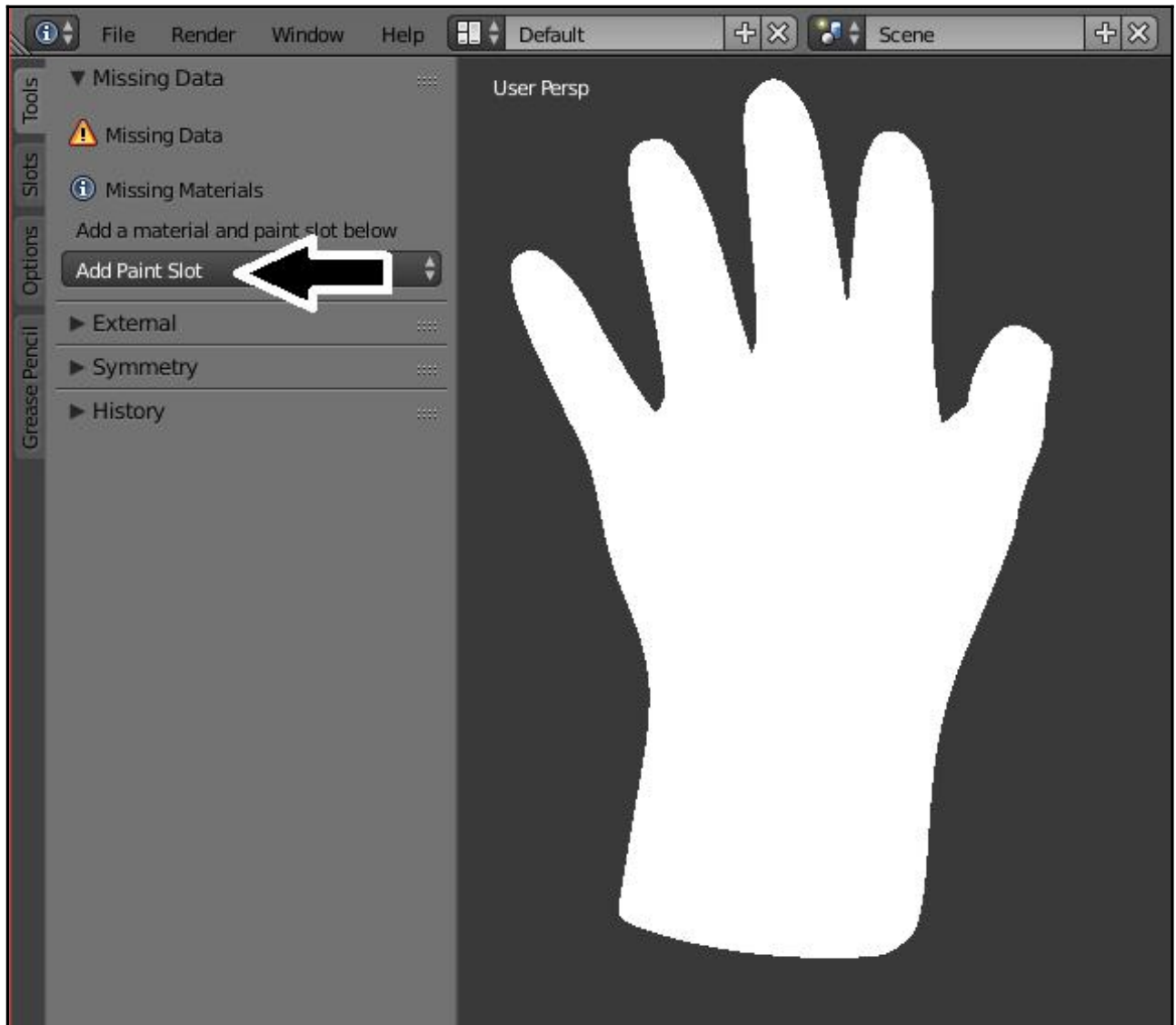

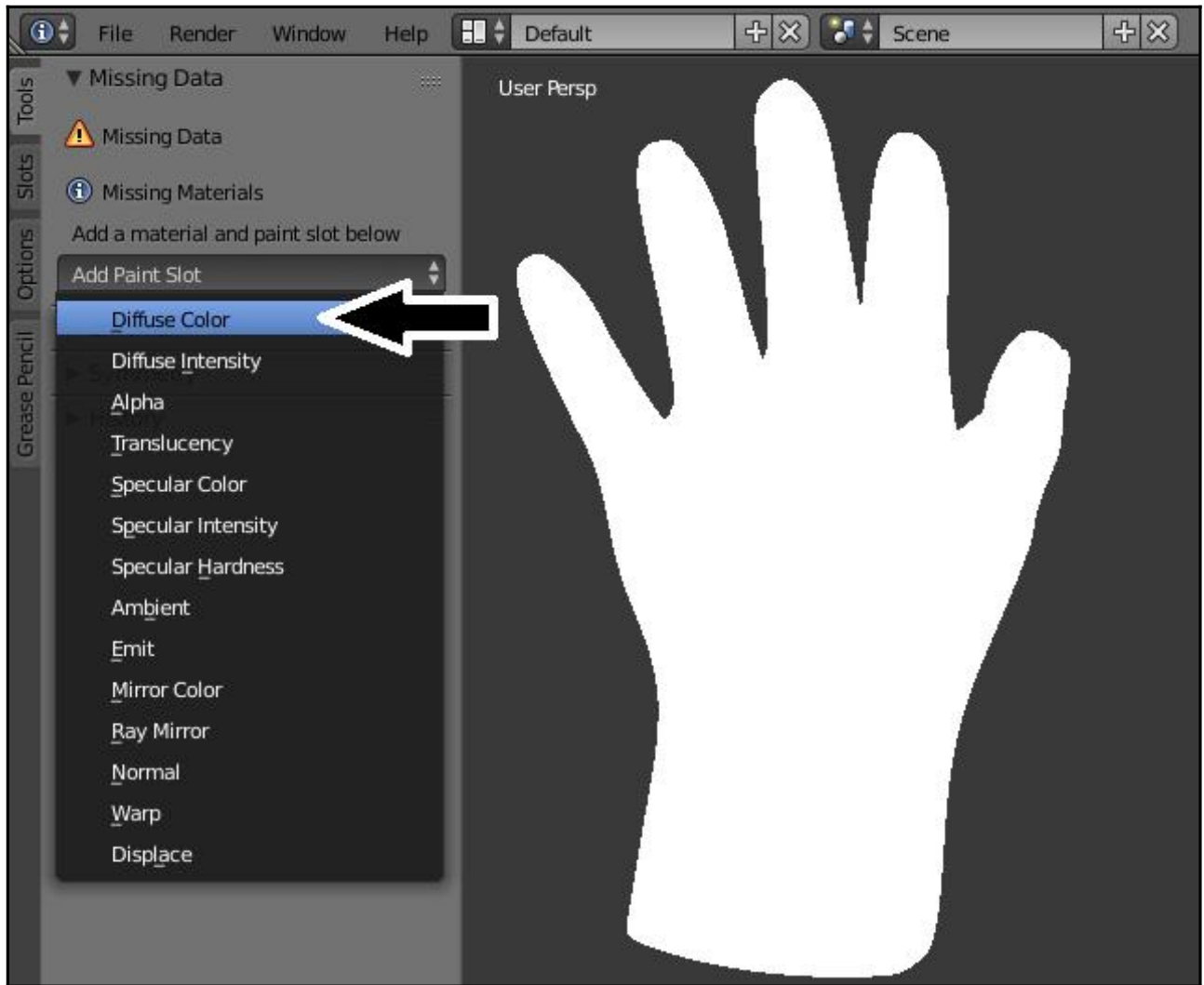

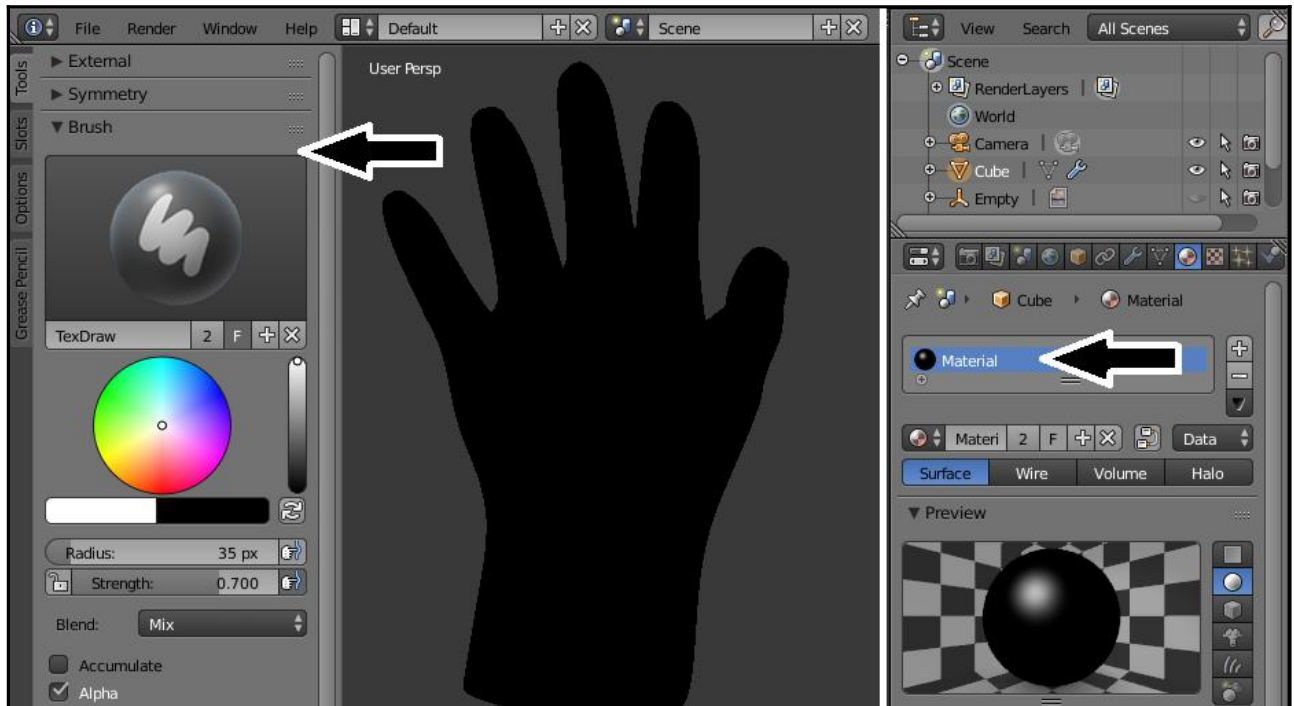
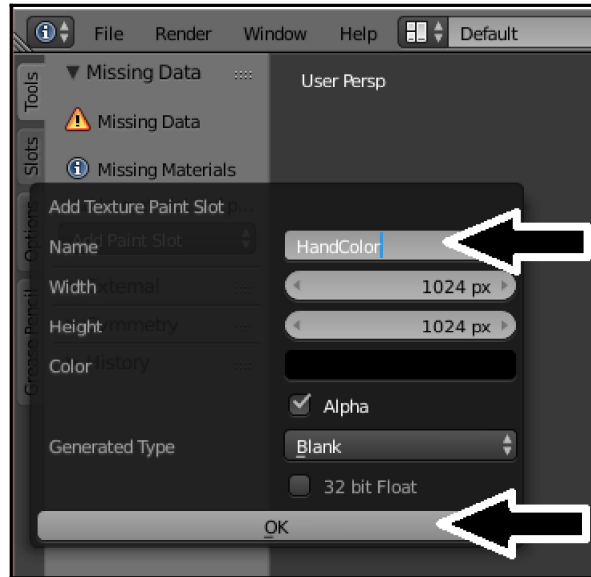

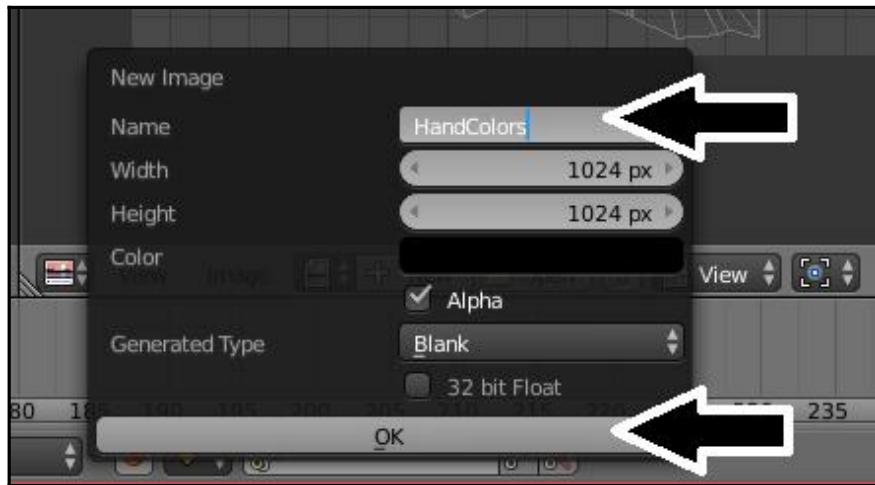
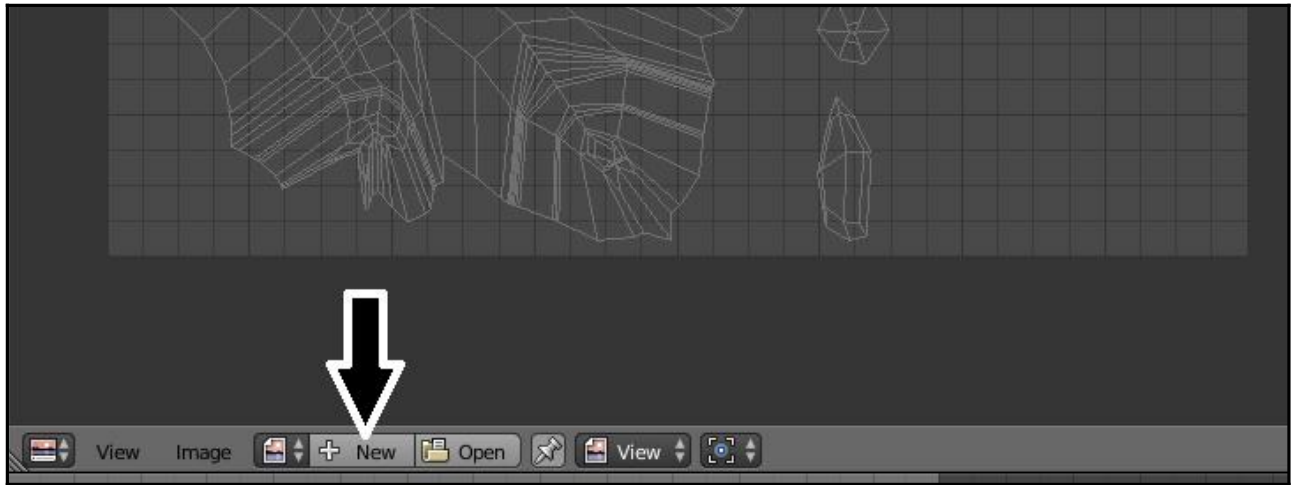

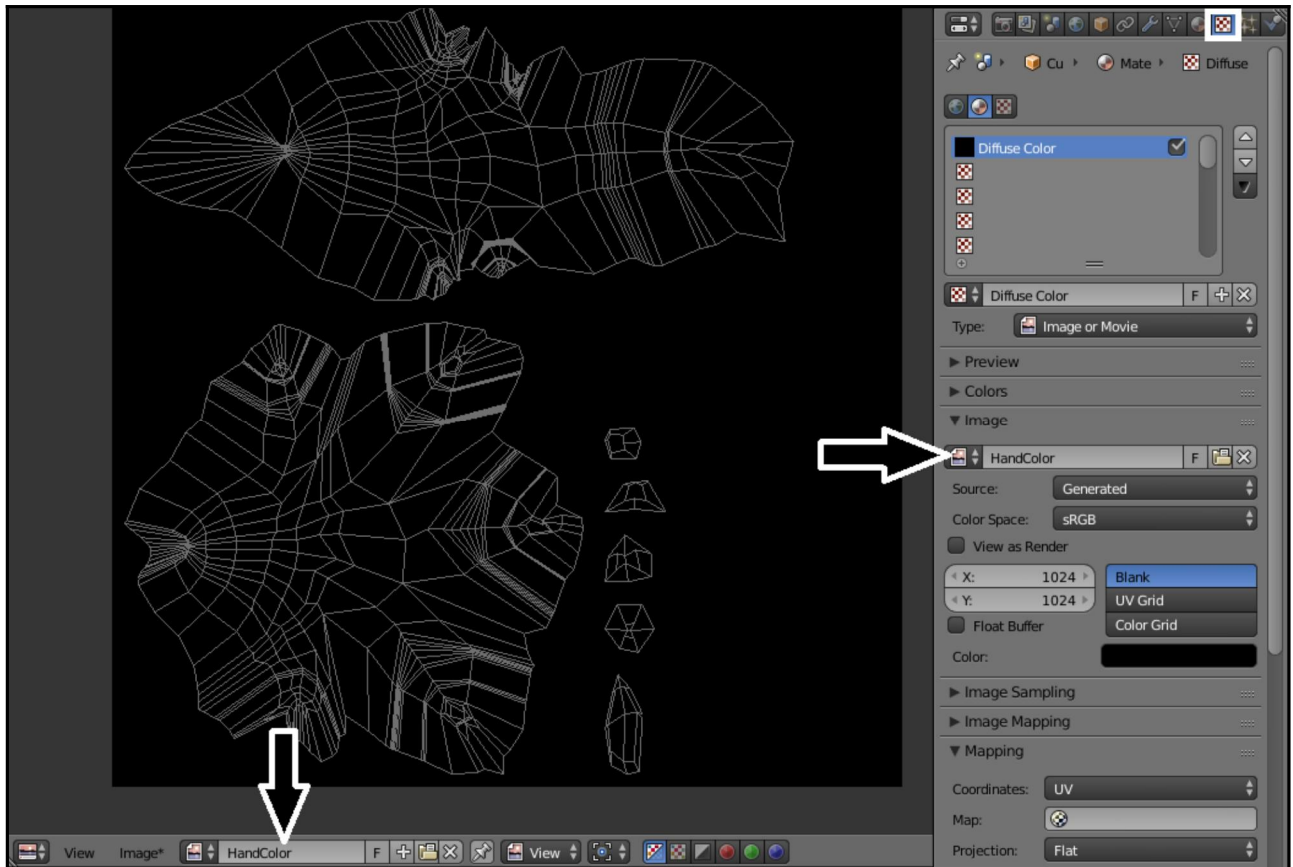
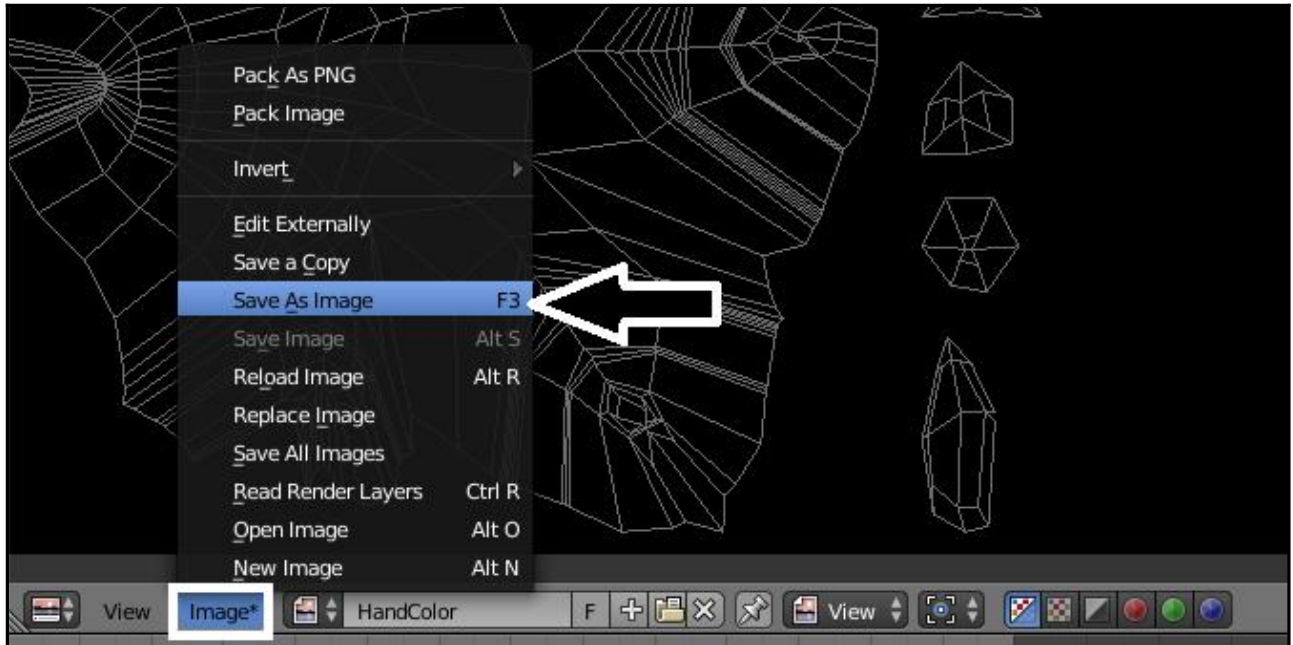





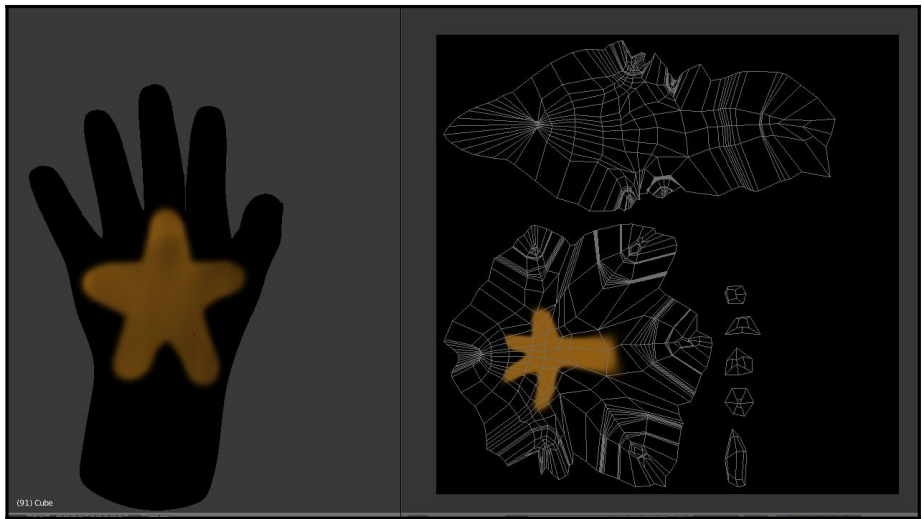
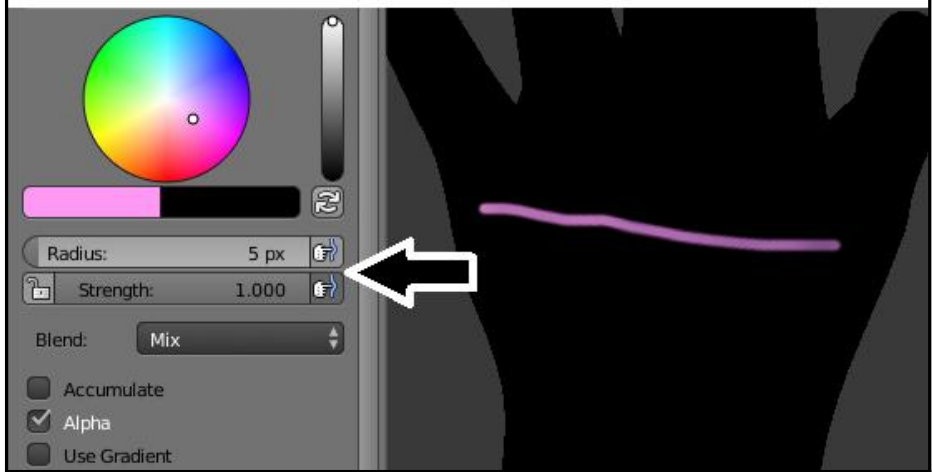
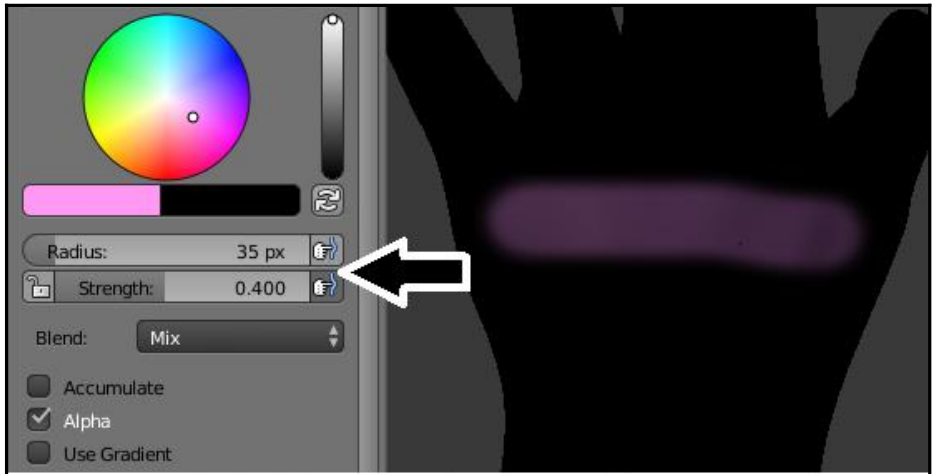

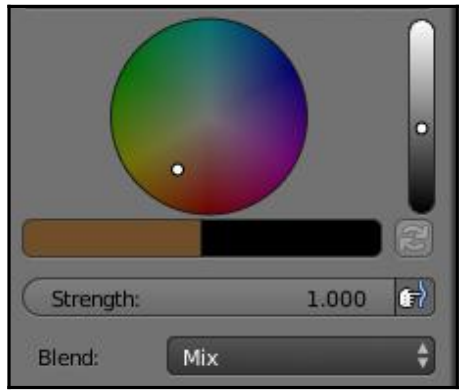
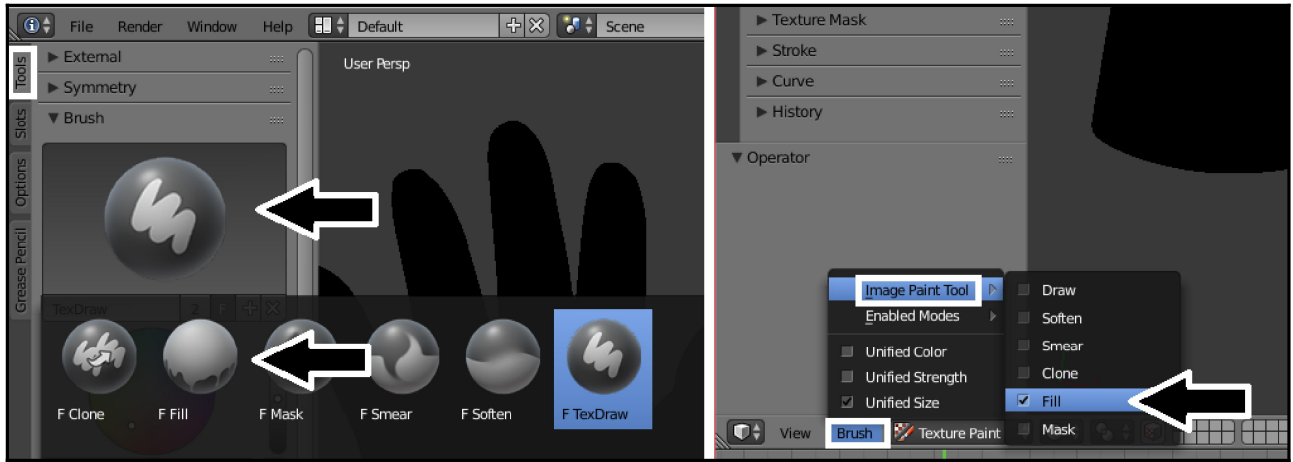

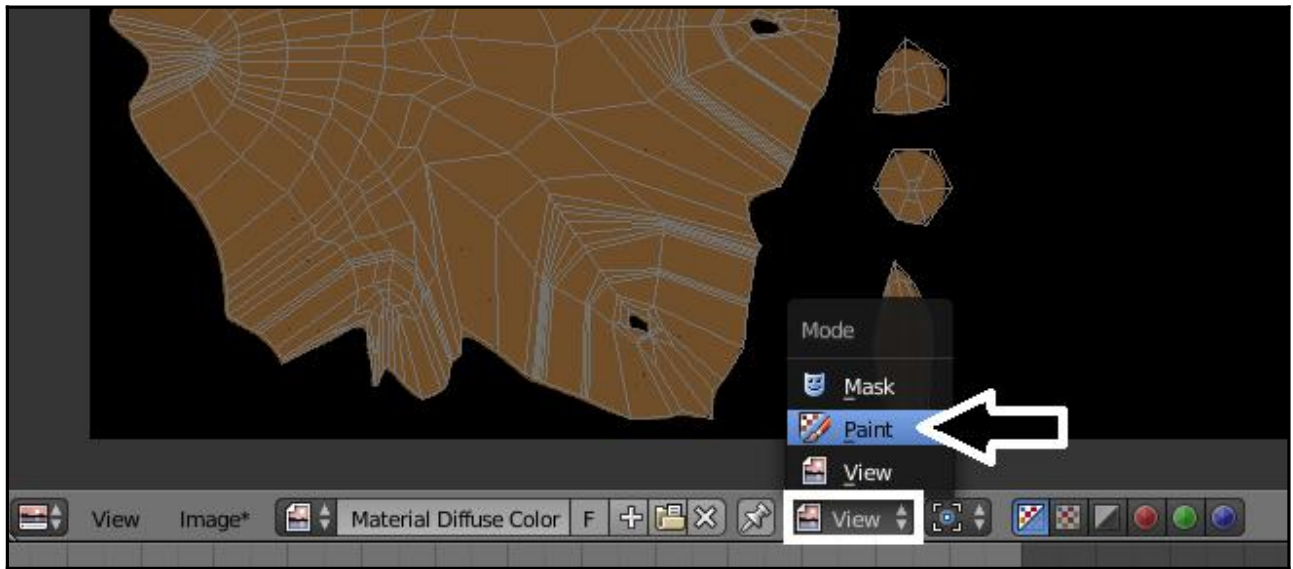
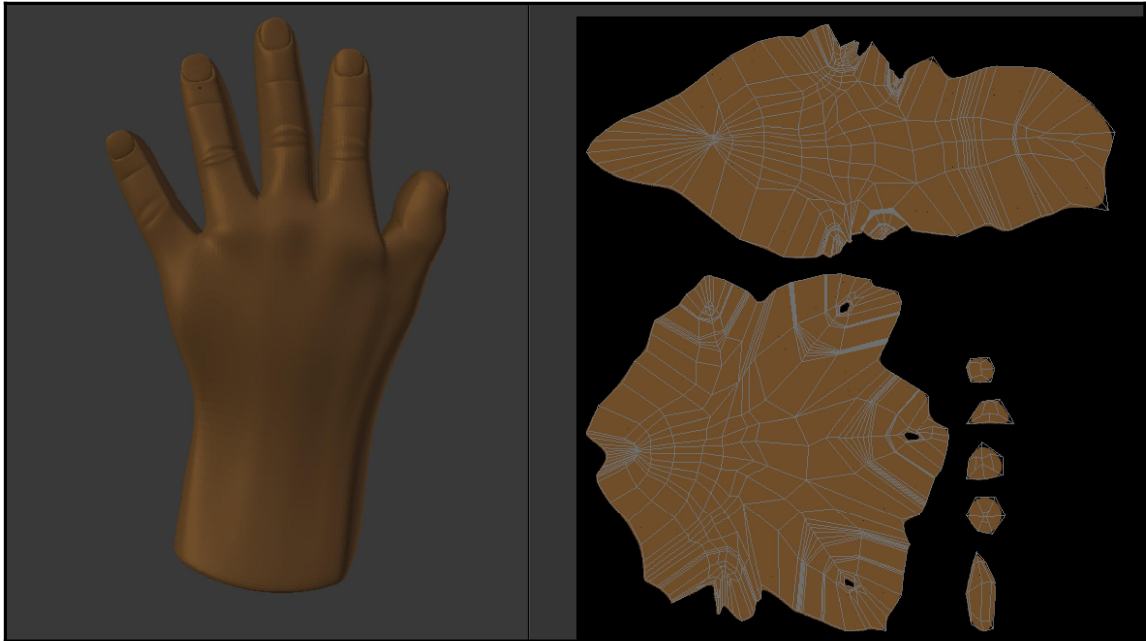

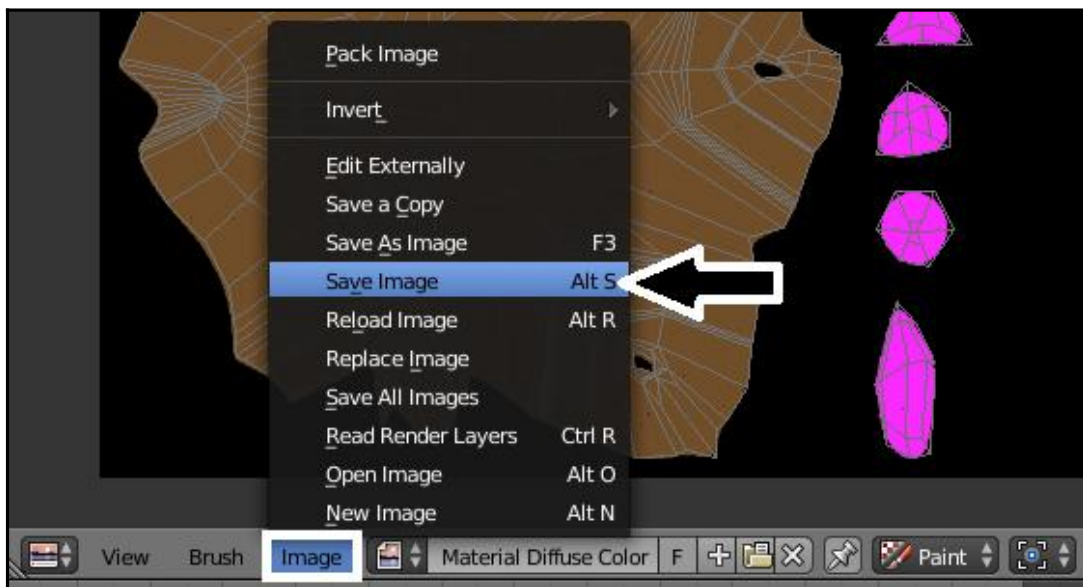

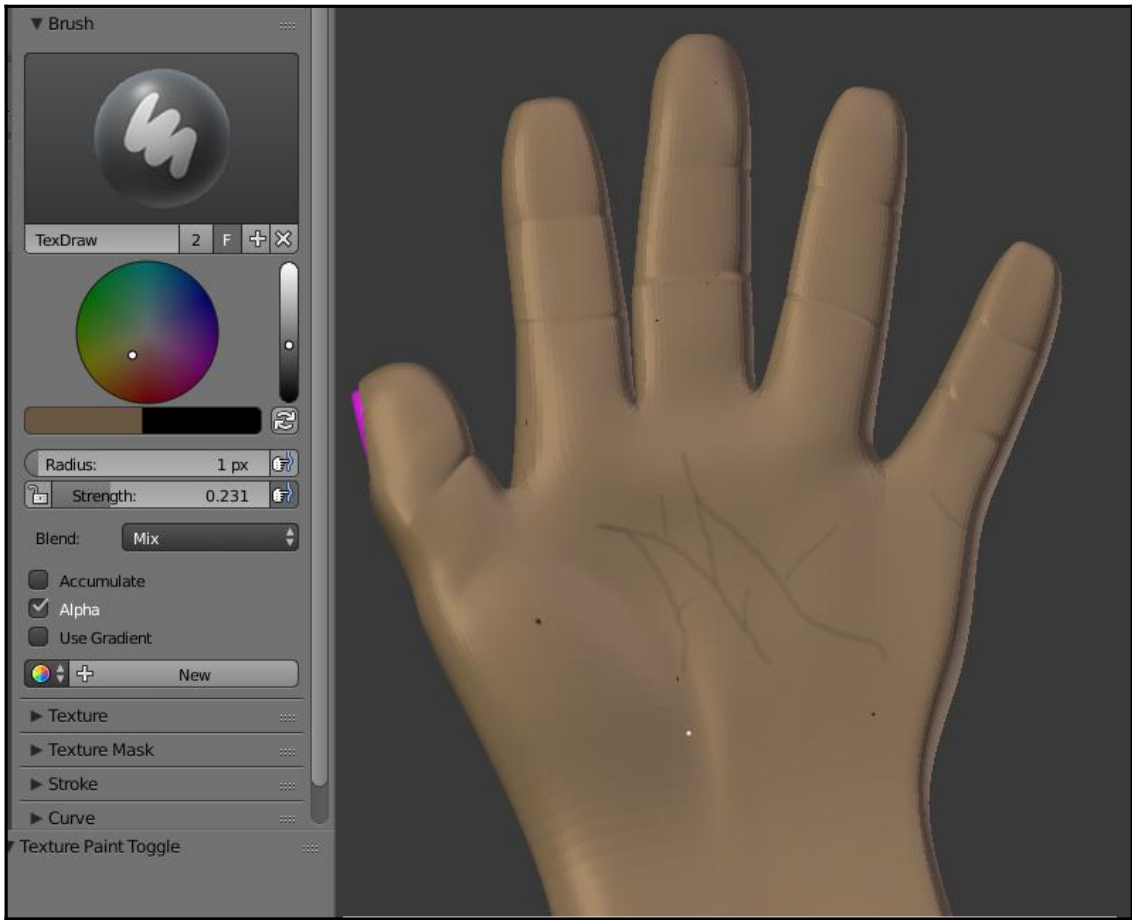
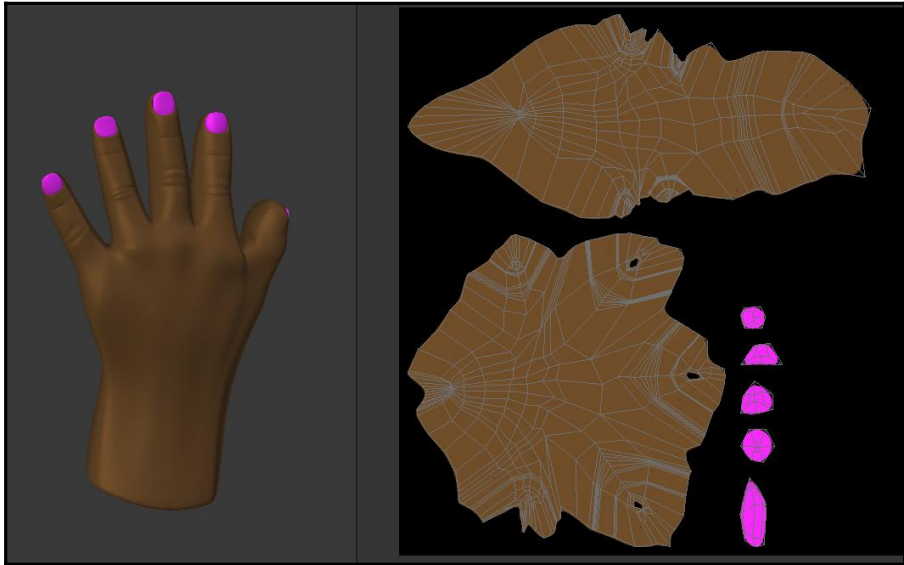

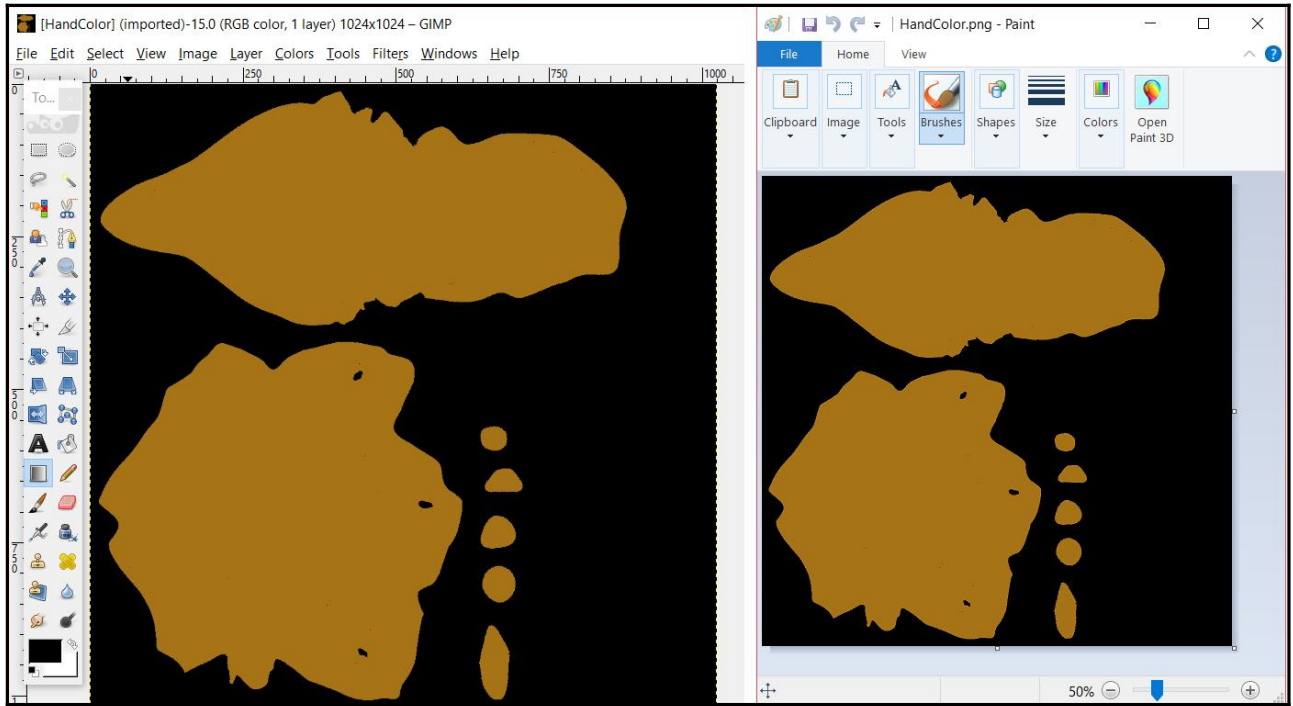

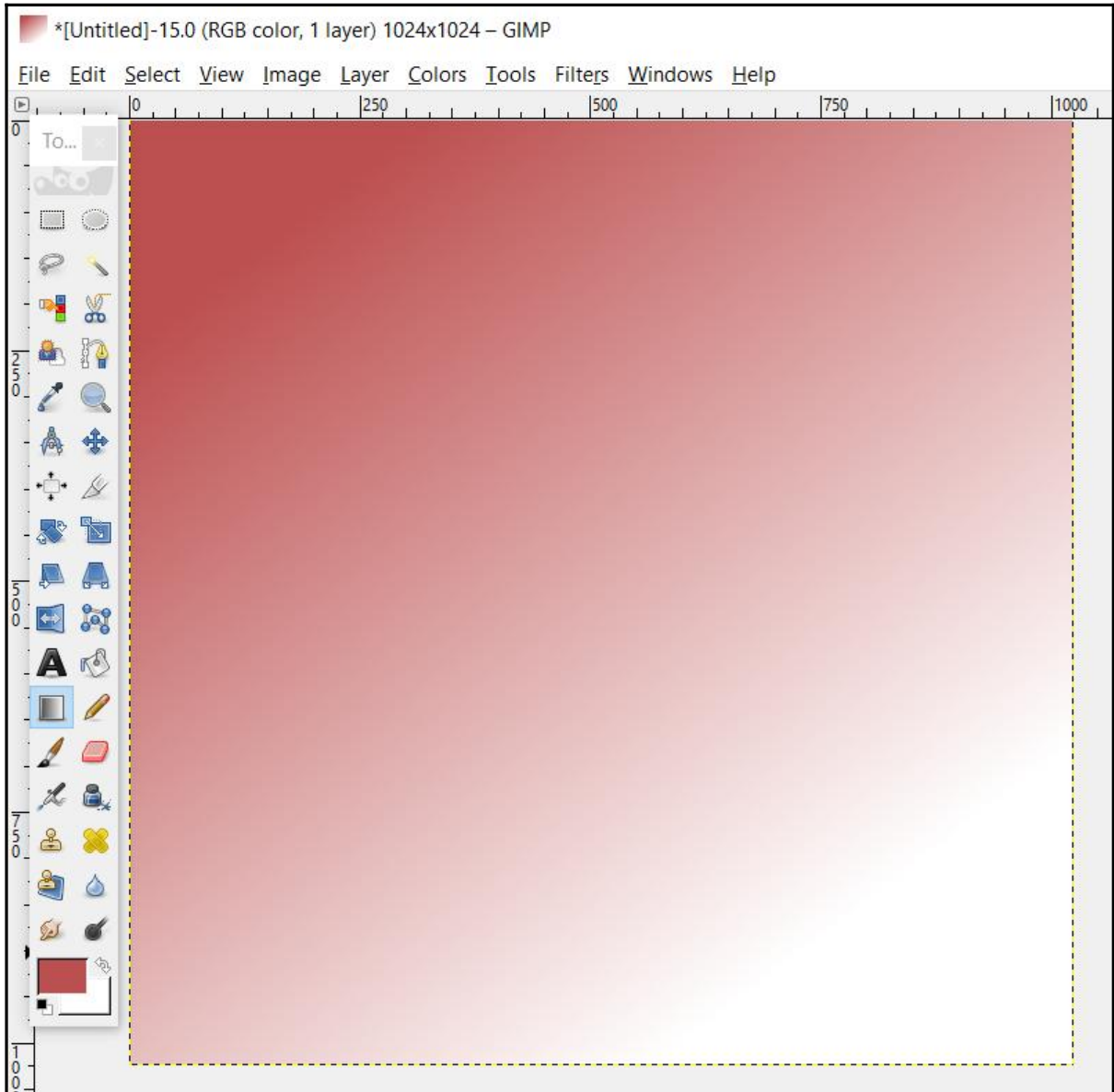



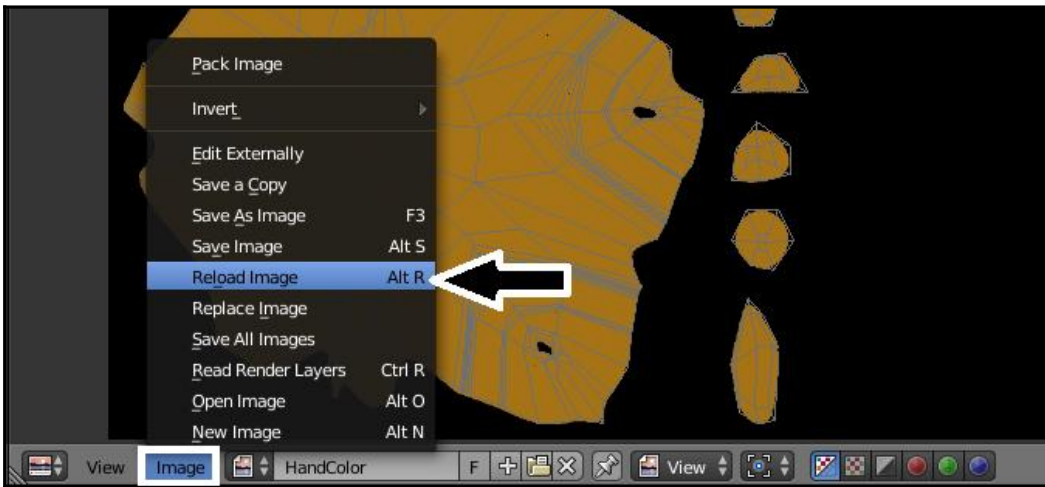
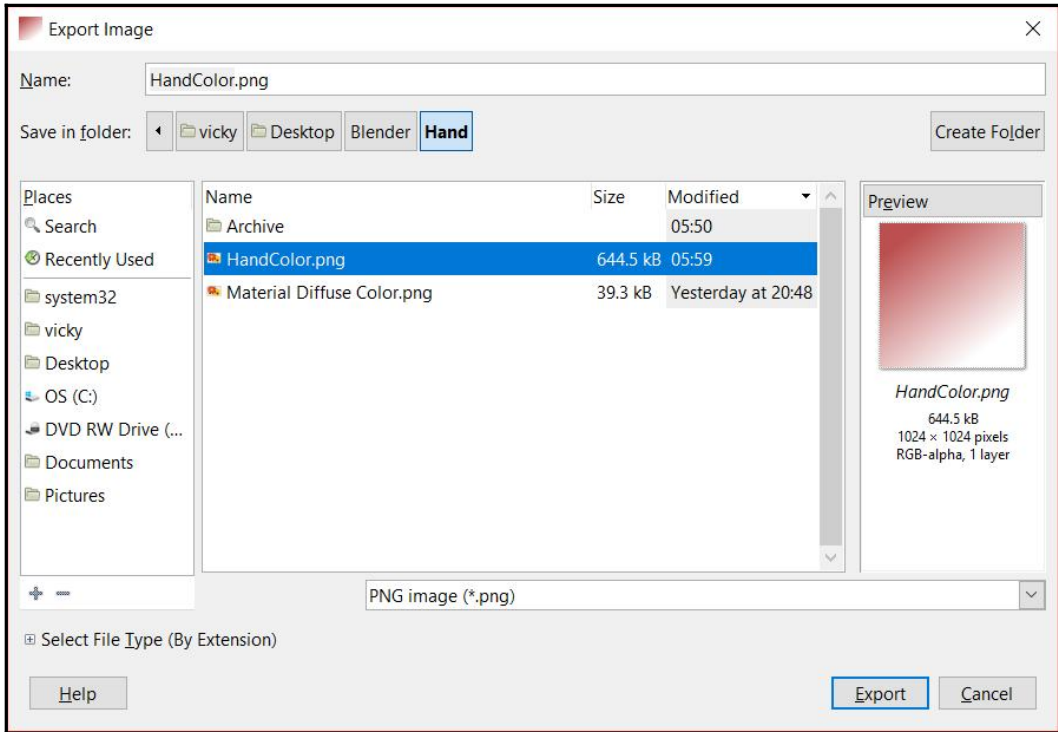

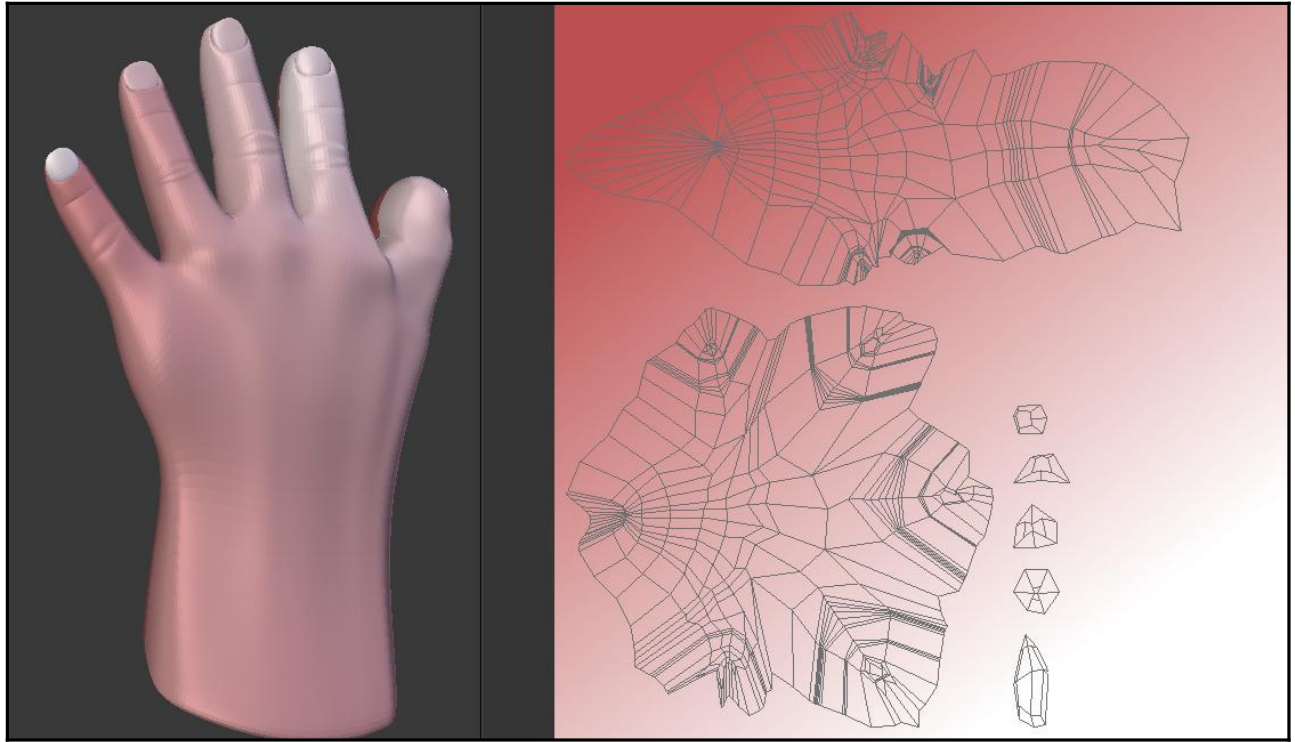

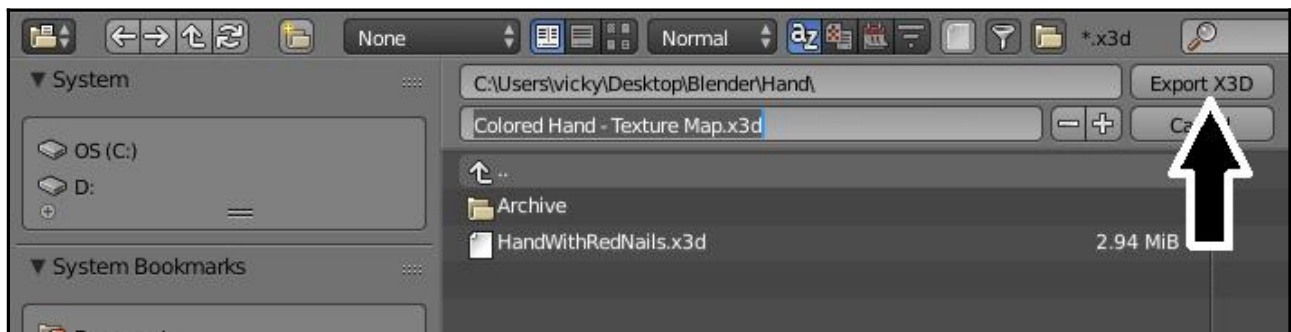
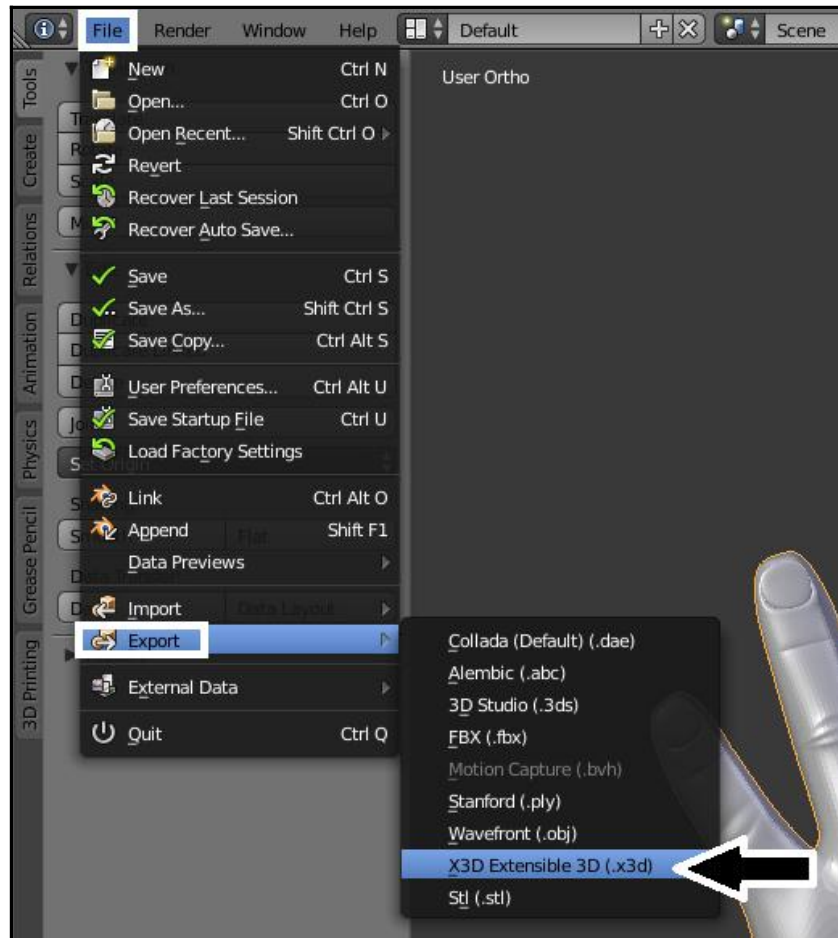

```
Colored Hand - Texture Map.x3d - Notepad
File Edit Format View Help
<Group DEF="group_ME_Cube">
  <Shape>
    <Appearance>
      <ImageTexture DEF="IM_Material_Diffuse_Color"
        url="HandColor.png" "ricky/Desktop/Ble
        />
      <TextureTransform
```

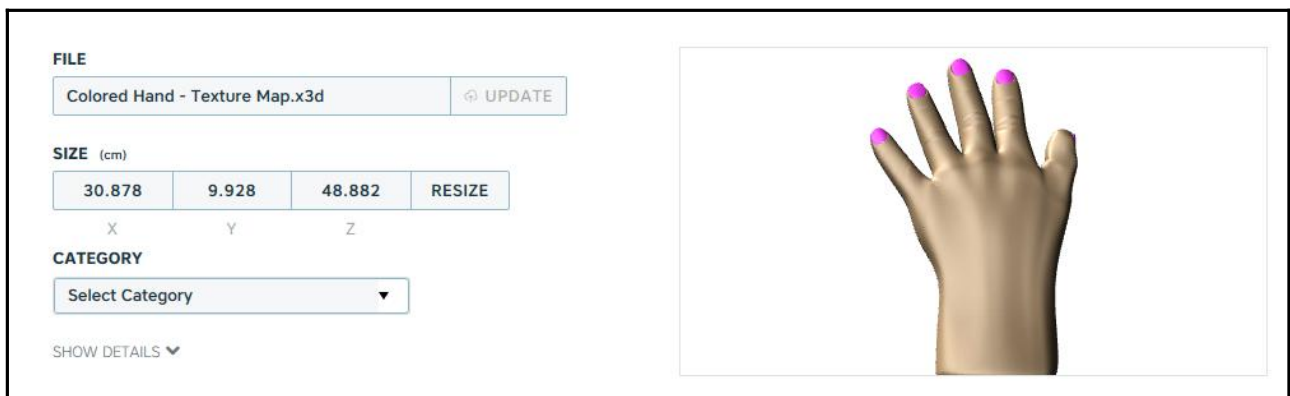
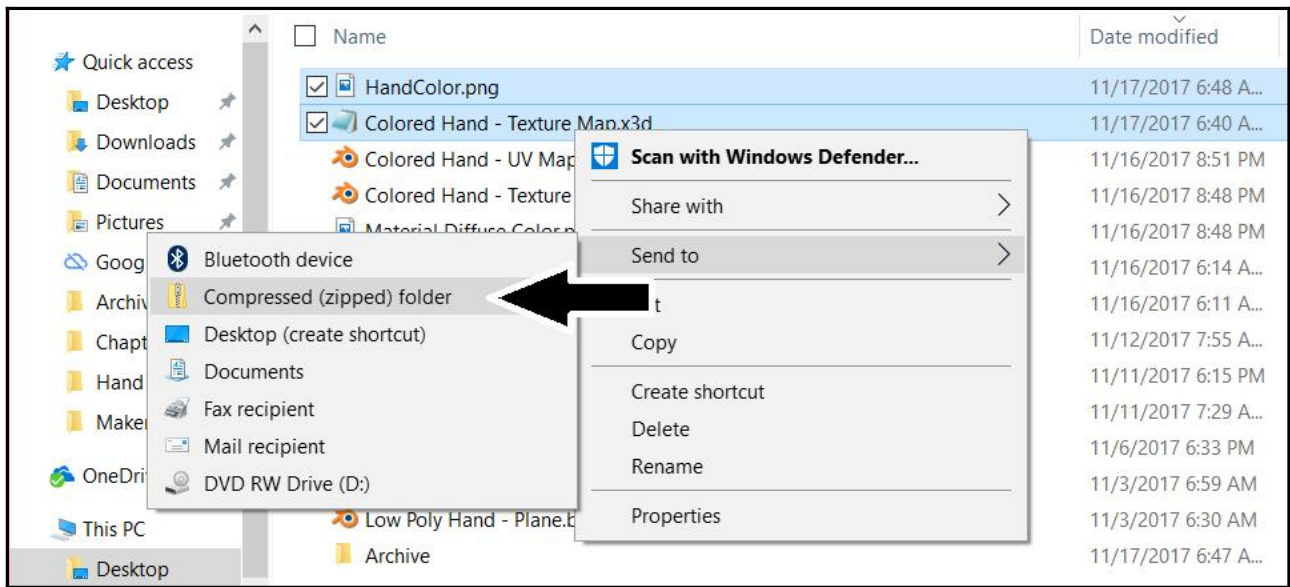

# Chapter 15: Troubleshooting and Repairing Models

