

Chapter 01: Azure App Service

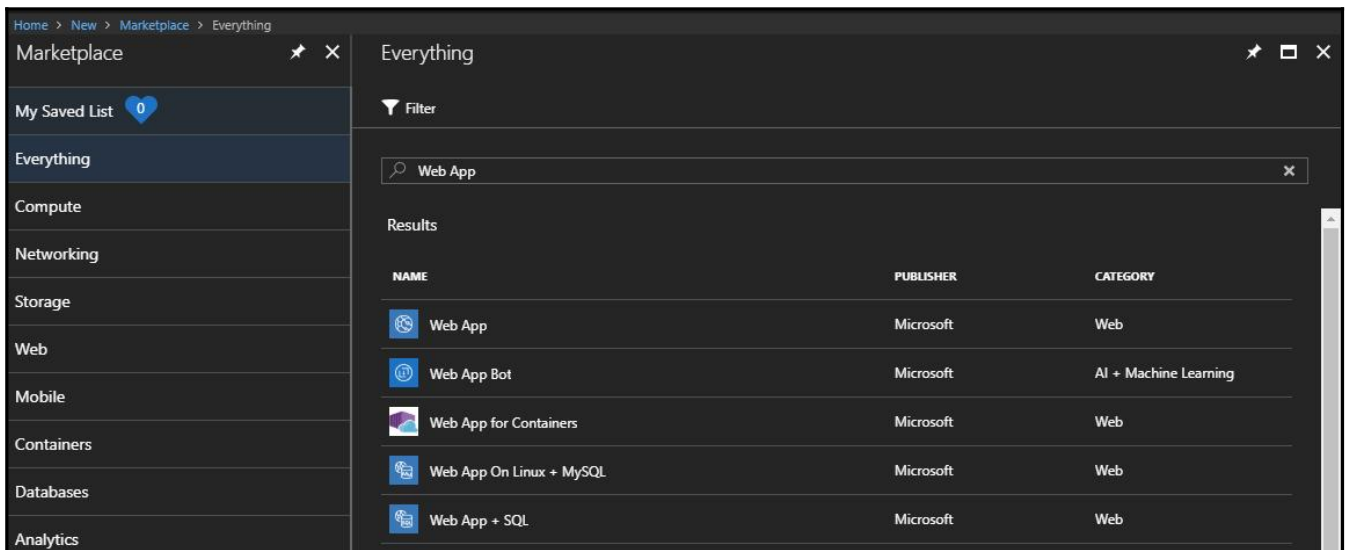
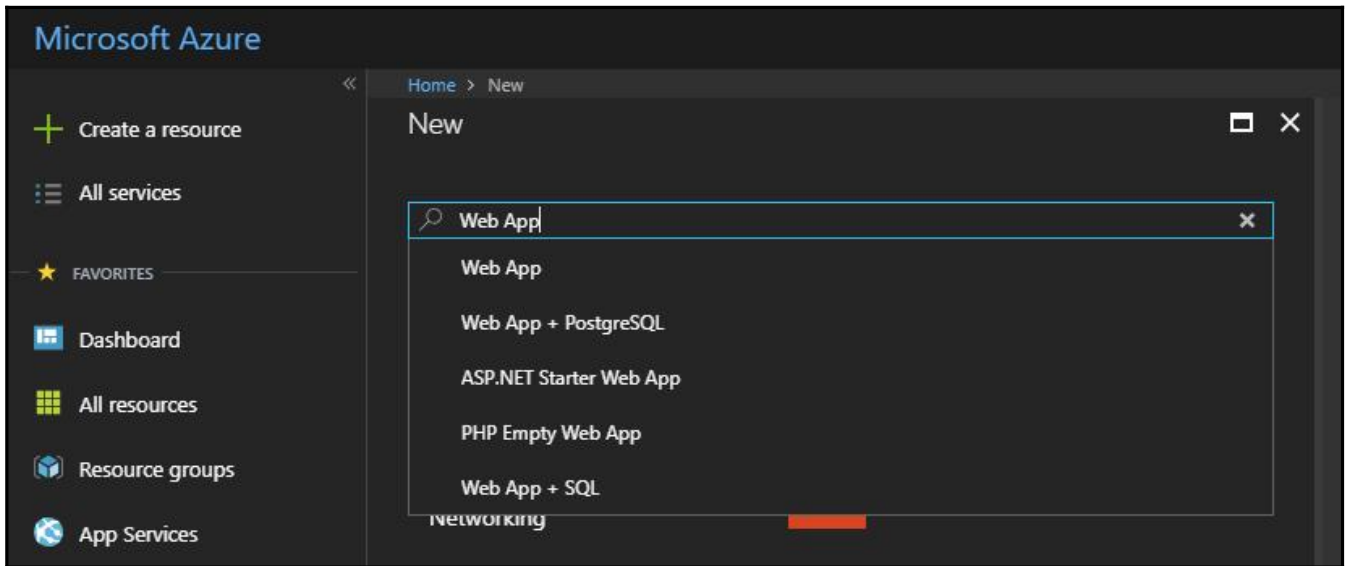

Home > New > Marketplace > Everything > Web App > Web App

Web App

Create

* App name

.azurewebsites.net

* Subscription
Visual Studio Enterprise

* Resource Group ⓘ
 Create new Use existing

* OS **Windows** Linux Docker

* App Service plan/Location
codenovapl-appserviceplan(Wes... >

Application Insights ⓘ **On** Off

New App Service Plan

Create a plan for the web app

* App Service plan

* Location
Central US

* Pricing tier
S1 Standard >

Home > New > Marketplace > Everything > Web App > Web App > App Service plan > New App Service Plan



Dev / Test
For less demanding workloads



Production
For most production workloads



Isolated
Advanced networking and scale

Recommended pricing tiers

| | | | |
|--|--|--|---|
| S1 1x cores 1.75 GB memory A-Series compute 37.57 EUR/Month (Estimated) | P1v2 1x cores 3.5 GB memory Dv2-Series compute 125.44 EUR/Month (Estimated) | P2v2 2x cores 7 GB memory Dv2-Series compute 250.95 EUR/Month (Estimated) | P3v2 4x cores 14 GB memory Dv2-Series compute 501.90 EUR/Month (Estimated) |
|--|--|--|---|

See additional options

Included features

Every app hosted on this App Service plan will have access to these features:

- Custom domains / SSL**
Configure and purchase custom domains with SNI and IP SSL bindings
- Auto scale**
Up to 20 instances. Subject to availability.
- Staging slots**
Up to 20 staging slots to use for testing and deployments before swapping them into production.
- Daily backups**
Backup your app 50 times daily.
- Traffic manager**
Improve performance and availability by routing traffic between multiple instances of your app.

Included hardware

Every instance of your App Service plan will include the following hardware configuration:

- CPU**
Dedicated Dv2-series compute resources used to run applications deployed in the App Service Plan. [Learn more](#)
- Memory**
Memory per instance available to run applications deployed and running in the App Service plan.
- Storage**
250 GB disk storage shared by all apps deployed in the App Service plan.

New App Service Plan

Create a plan for the web app

- * App Service plan

✓
- * Location

▼
- * Pricing tier

➤

Web App

Create

* App name
 ✓
 .azurewebsites.net

* Subscription
 ▾

* Resource Group ⓘ
 Create new Use existing
 ✓

* OS Windows Linux Docker

* App Service plan/Location
 >

Application Insights ⓘ On Off

Home > All resources

All resources

Demant Group Services

+ Add | Edit columns | Refresh | Assign Tags | Delete

i Subscription filtering behaviour has now changed. To learn more [click here](#).

Subscriptions: 1 of 12 selected – Don't see a subscription? [Switch directories](#)

| ▾ | ▾ | ▾

2 items Show hidden types ⓘ

| <input type="checkbox"/> | NAME ↑ | TYPE ↑ | RESOURCE GROUP ↑ |
|--------------------------|----------------|------------------|------------------|
| <input type="checkbox"/> | cloudcomrade | App Service plan | handsonazure-rg |
| <input type="checkbox"/> | cloudcomrade01 | App Service | handsonazure-rg |

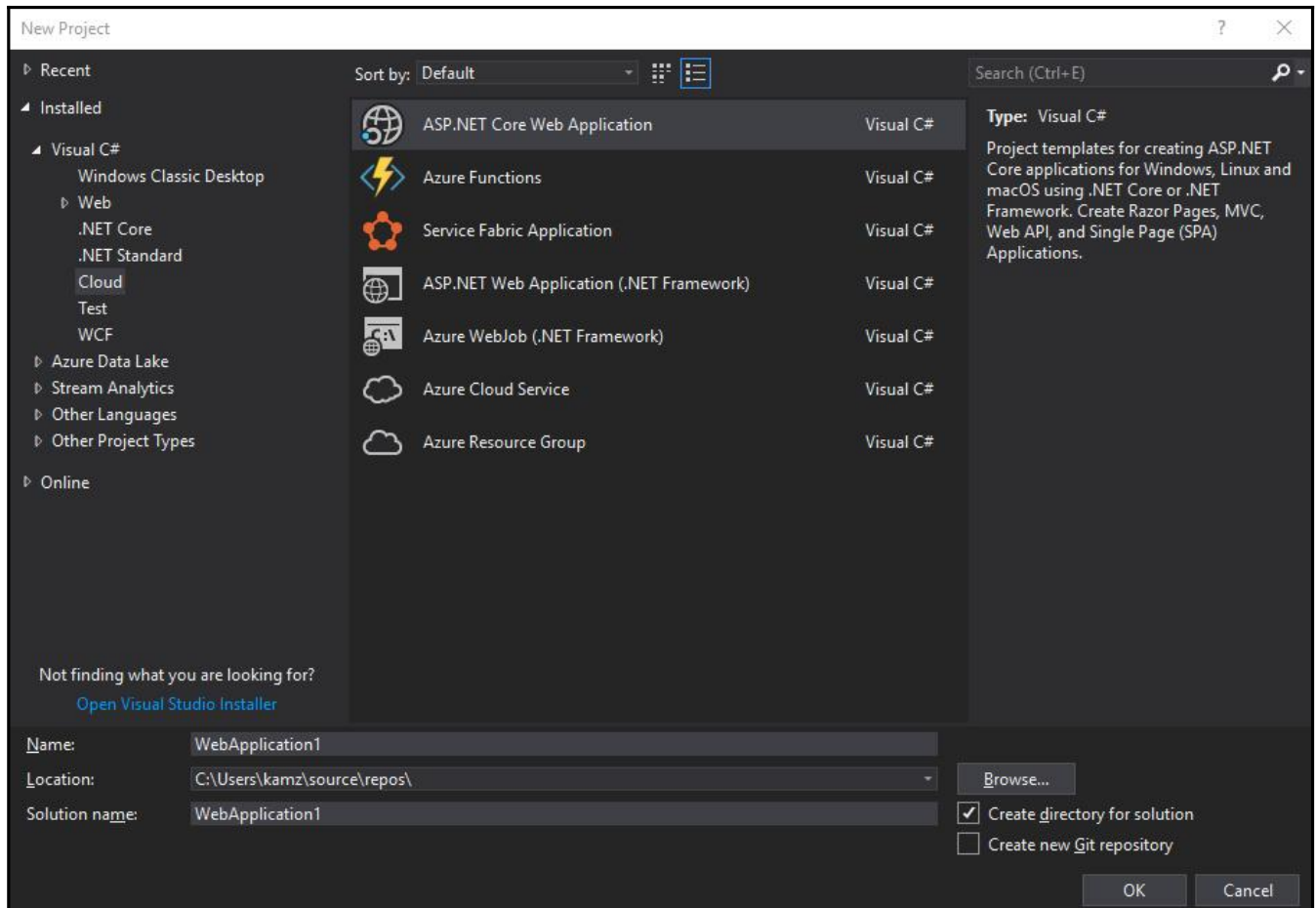

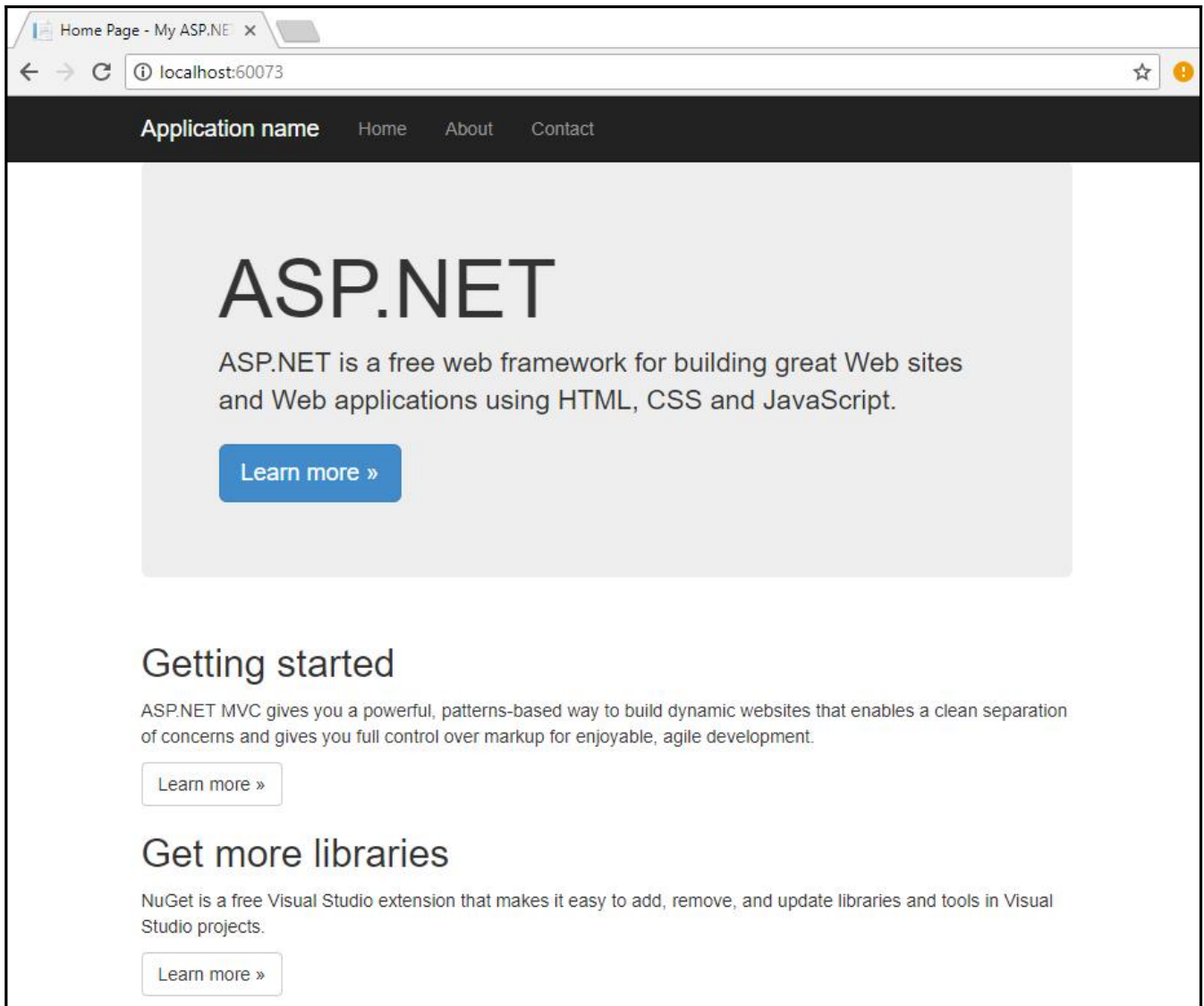

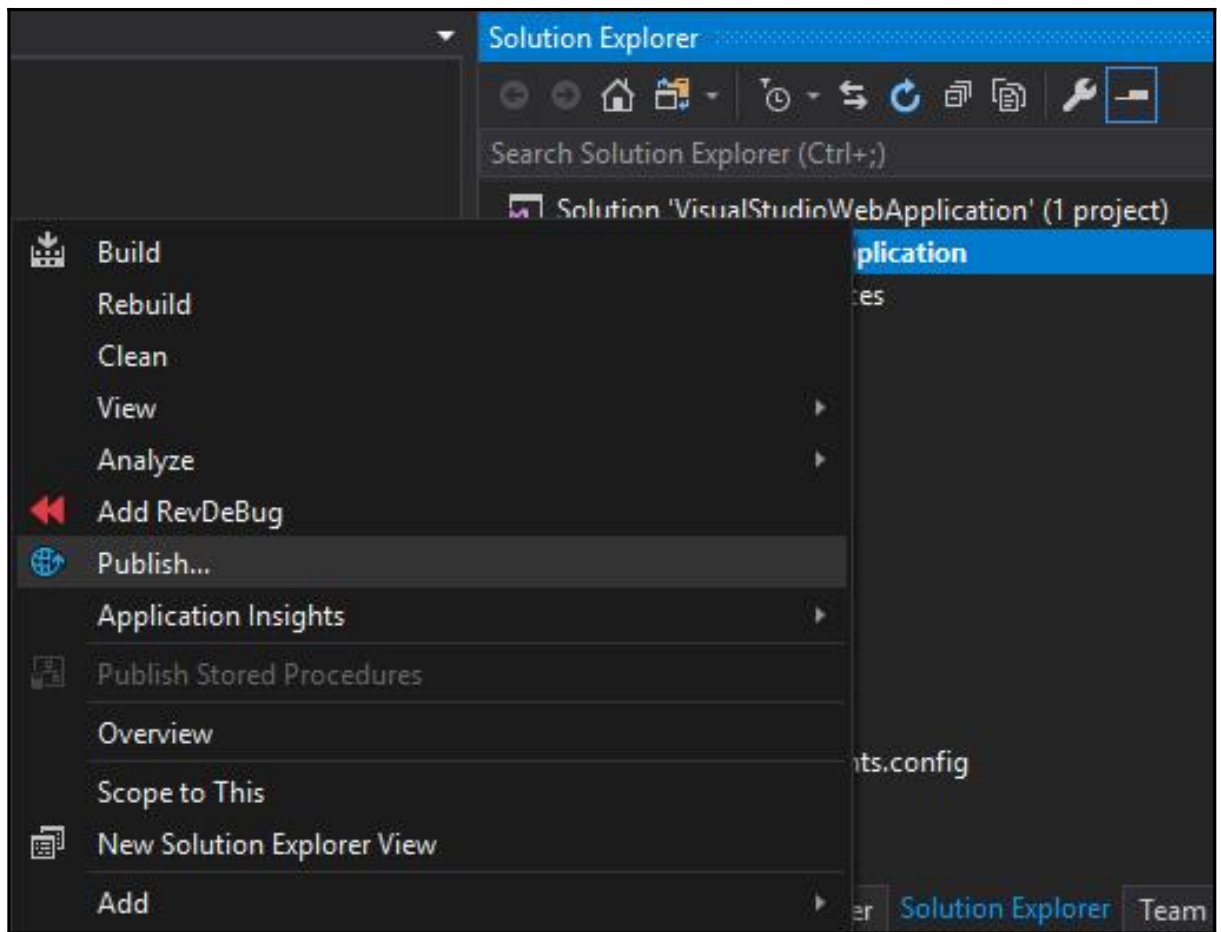

Create App Service

Host your web and mobile applications, REST APIs, and more in Azure

Demant Group Services
kamz@demant-technology.com

App Name
cloudcomradevisualstudio

Subscription
Visual Studio Enterprise

Resource Group
handsonazure-rg (westeurope) [New...](#)

Hosting Plan
cloudcomrade (West Europe, F1) [New...](#)

Export...

Explore additional Azure services
[Create a SQL Database](#)

Clicking the Create button will create the following Azure resources

App Service - cloudcomradevisualstudio

Create Cancel

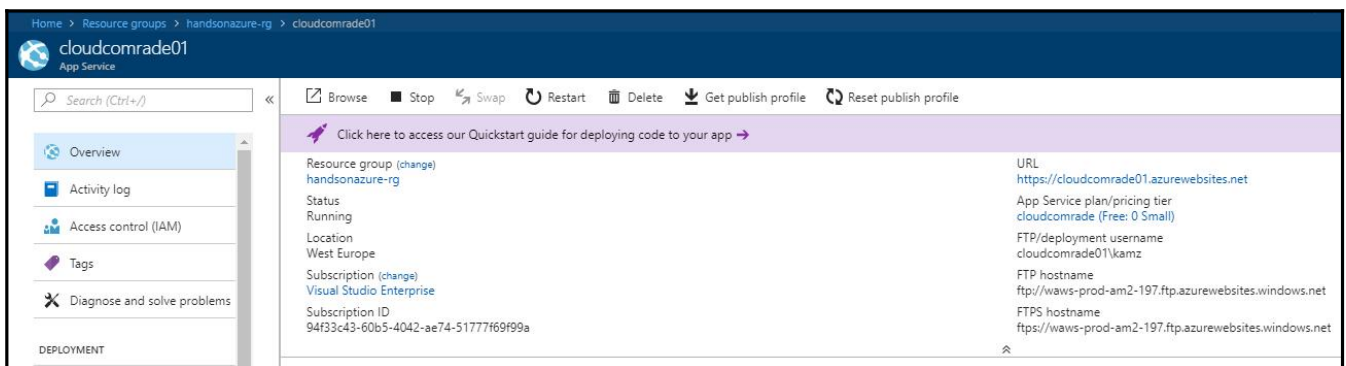
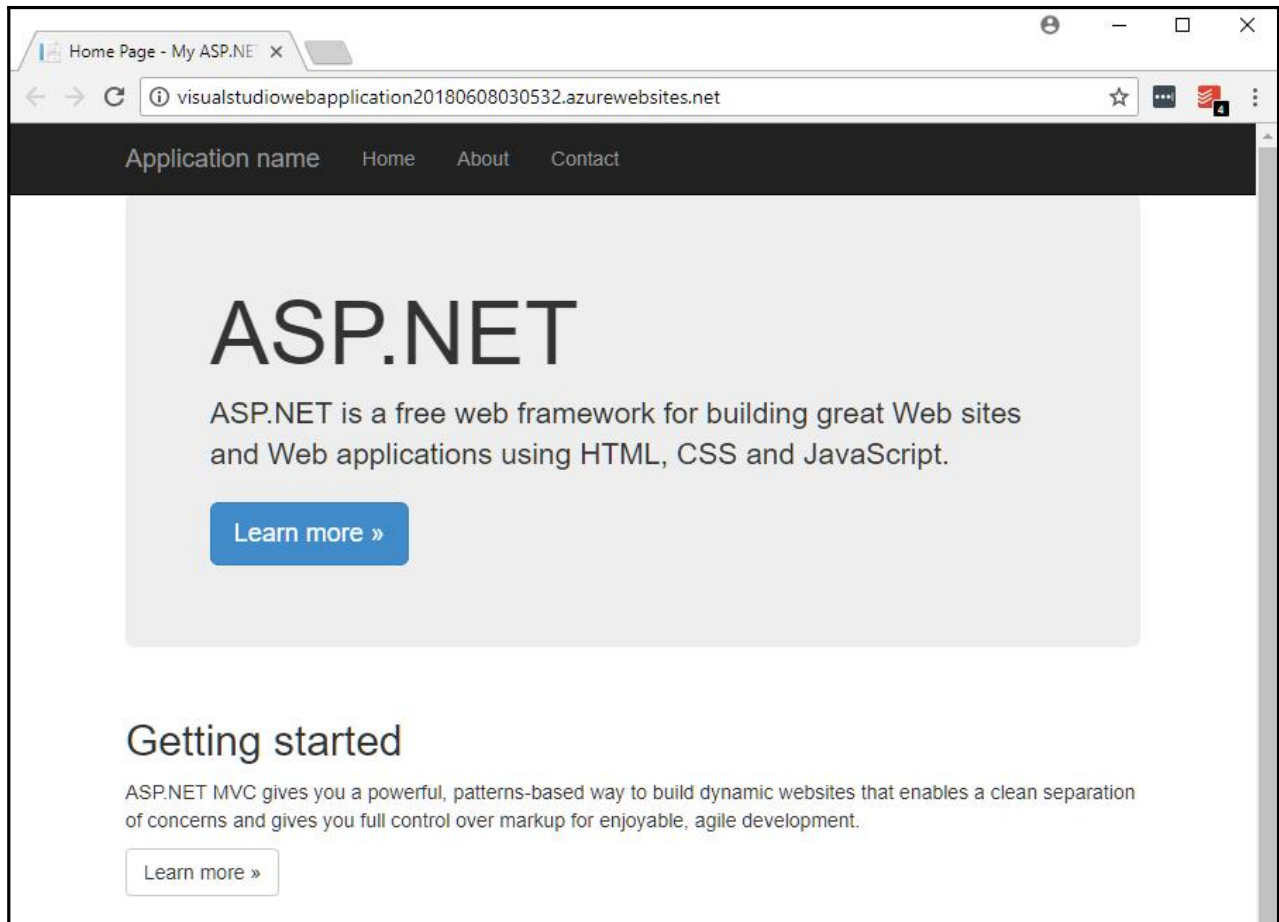

Home > Resource groups > handsonazure-rg > cloudcomrade01 - Deployment credentials

cloudcomrade01 - Deployment credentials

App Service

Search (Ctrl+/) Save Discard

- Overview
- Activity log
- Access control (IAM)
- Tags
- Diagnose and solve problems

DEPLOYMENT

- Quickstart
- Deployment credentials
- Deployment slots

Deployment Credentials

Local Git and FTP can't authenticate using the credentials used for subscriptions associated with your Microsoft Azure account. [Learn](#)

* FTP/deployment username ⓘ

kamz

* Password ⓘ

* Confirm password

cloudcomrade01%5Ckamz@waws-prod-am2-197.ftp.azurewebsites.windows.net - FileZilla

File Edit View Transfer Server Bookmarks Help

Host: waws-prod-am2-197 Username: dcomrade01\kamz Password: Port: Quickconnect

Status: Initializing TLS...
 Status: Verifying certificate...
 Status: TLS connection established.
 Status: Logged in
 Status: Retrieving directory listing...
 Status: Directory listing of "/" successful

Remote site: /site/wwwroot

```
graph TD; Root[" / "] --- LogFiles[" LogFiles "]; Root --- site[" site "]; LogFiles --- kudu[" kudu "]; LogFiles --- trace[" trace "]; site --- deployments[" deployments "]; site --- tools[" tools "]; site --- locks[" locks "]; site --- wwwroot[" wwwroot "];
```

| Filename | Filesize | Filetype | Last modified | Permissions | Owner/Gro... |
|-------------------|----------|-------------|--------------------|-------------|--------------|
| .. | | | | | |
| hostingstart.html | 2 526 | Chrome H... | 06.06.2018 13:2... | | |

Remote site: /site/wwwroot

The file explorer shows a tree structure starting from the root directory '/'. The tree includes the following folders:

- LogFiles
- kudu
 - trace
- site
 - deployments
 - tools
 - locks
 - wwwroot

| Filename | Filesize | Filetype | Last modified | Permissions | Owner/Gro... |
|----------------------------|----------|----------------|--------------------|-------------|--------------|
| .. | | | | | |
| bin | | File folder | 08.06.2018 21:3... | | |
| Content | | File folder | 08.06.2018 21:3... | | |
| fonts | | File folder | 08.06.2018 21:3... | | |
| Scripts | | File folder | 08.06.2018 21:3... | | |
| Views | | File folder | 08.06.2018 21:3... | | |
| ApplicationInsights.config | 5 939 | XML Confi... | 08.06.2018 21:3... | | |
| favicon.ico | 32 038 | IrfanView I... | 08.06.2018 21:3... | | |
| Global.asax | 118 | ASP.NET S... | 08.06.2018 21:3... | | |
| hostingstart.html | 2 526 | Chrome H... | 06.06.2018 13:2... | | |
| Web.config | 3 473 | XML Confi... | 08.06.2018 21:3... | | |

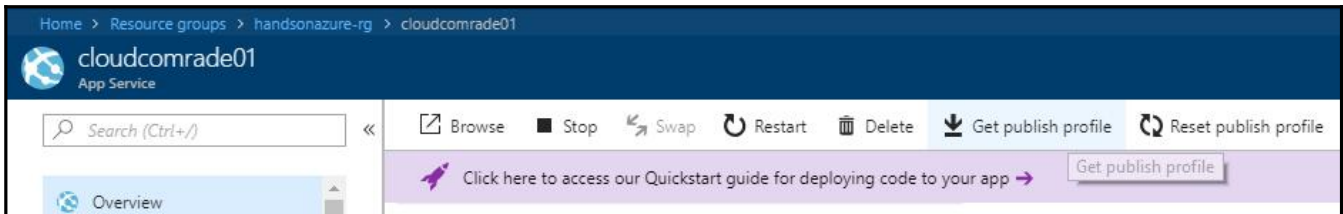
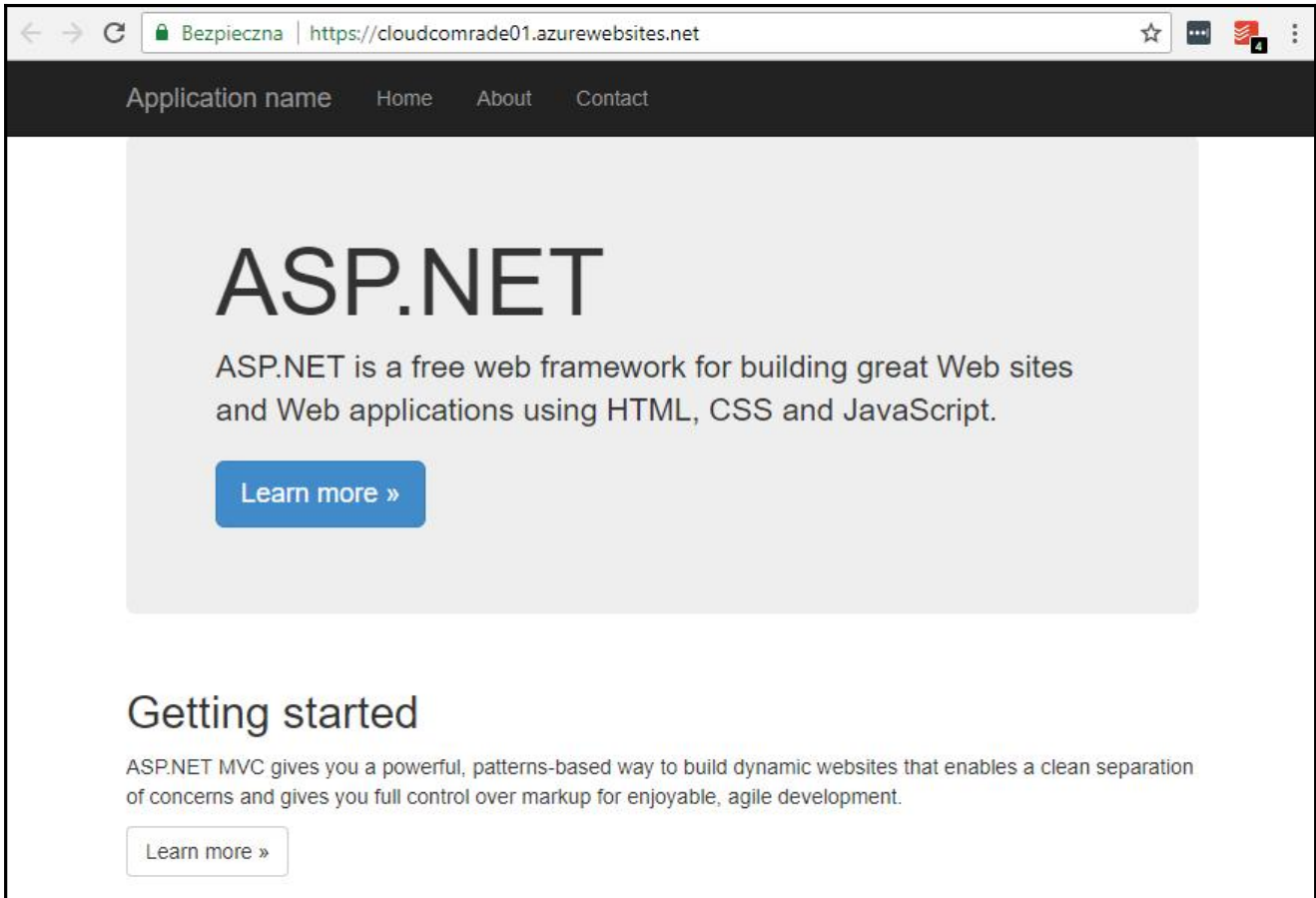

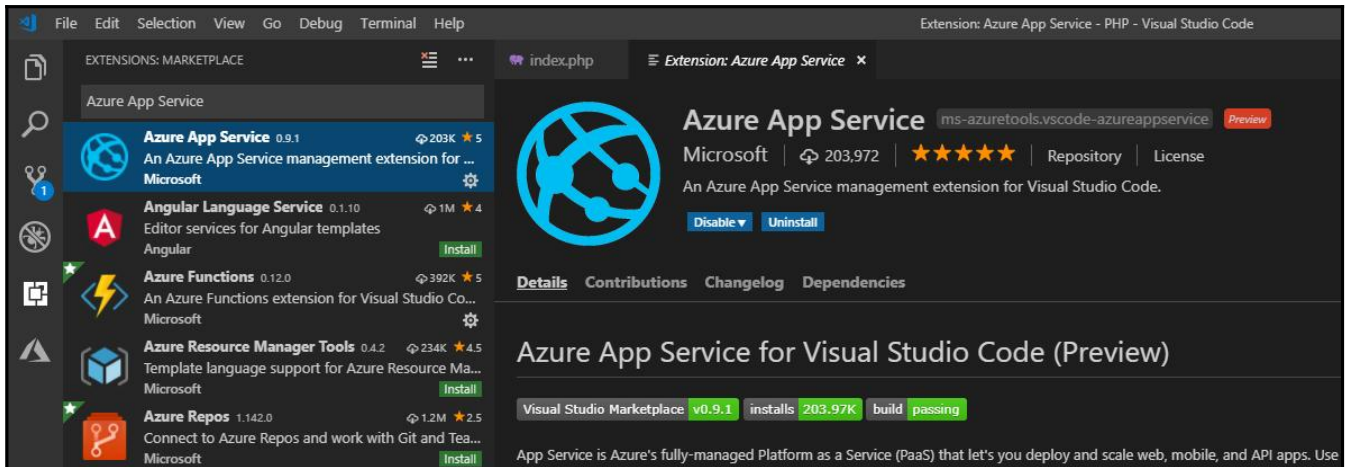
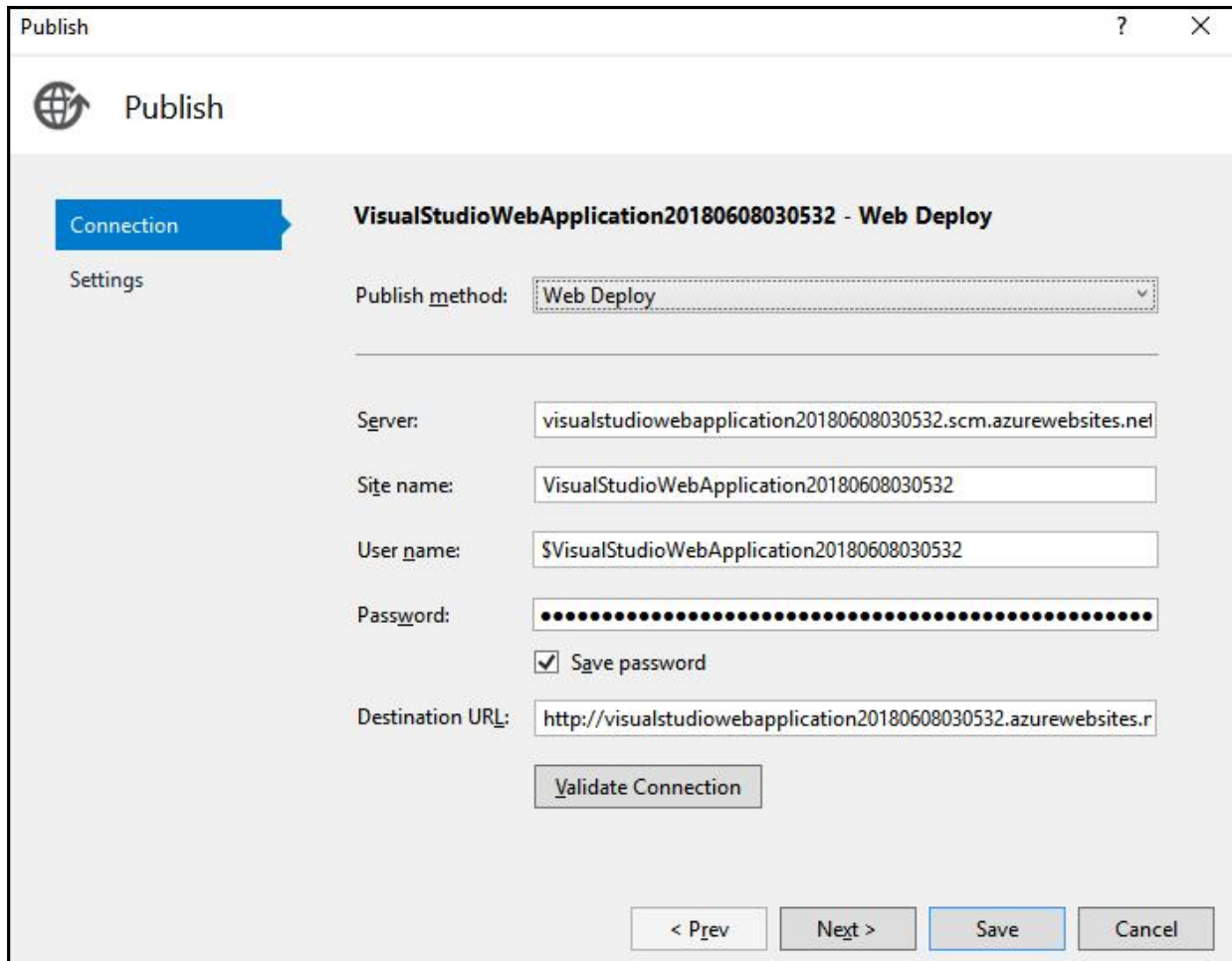

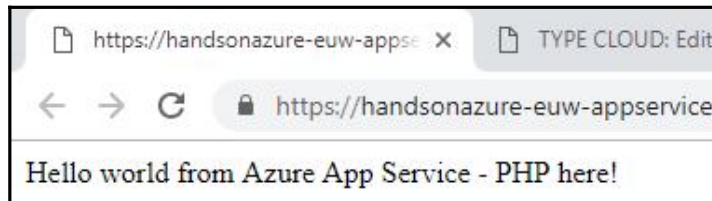
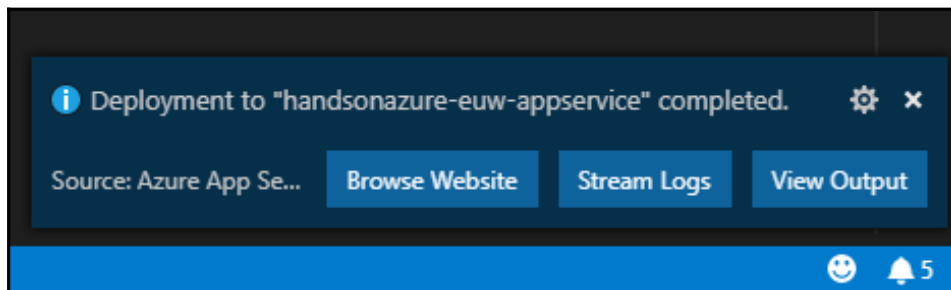
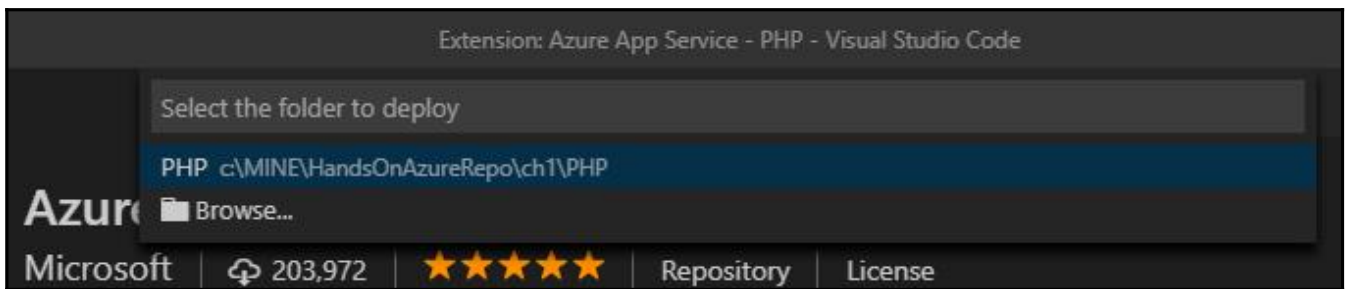
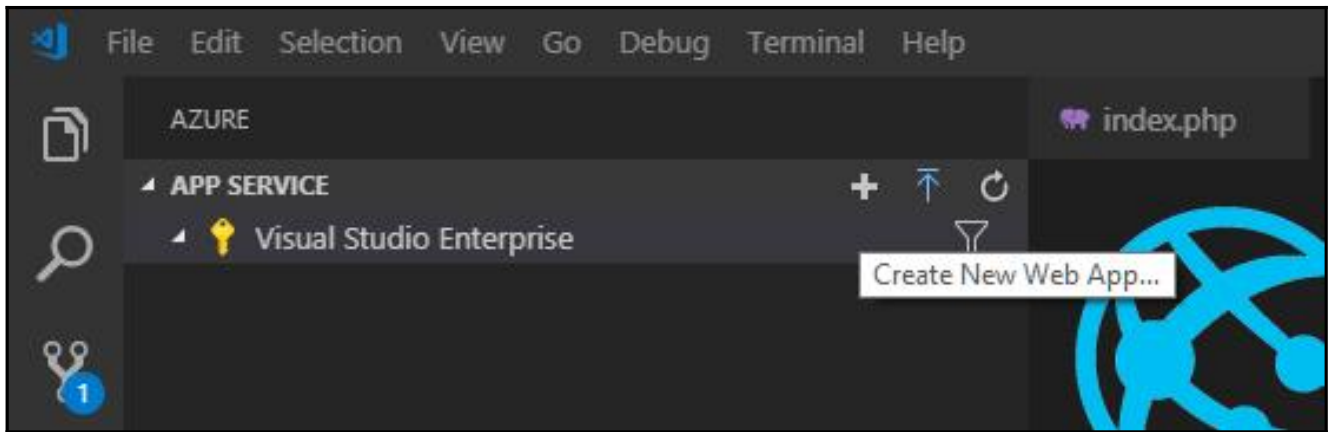

cloudcomrade01 - Application settings
App Service

Search (Ctrl+/) Save Discard

General settings



| | |
|--|-------------------------------------|
| .NET Framework version ⓘ | v4.7 |
| PHP version ⓘ | 5.6 |
| i App Service supports installing newer versions of Python. Click here to learn more. ↗ | |
| Python version ⓘ | Off |
| Java version ⓘ | Off |
| Java minor version ⓘ | |
| Java web container ⓘ | |
| Platform ⓘ | Upgrade to enable ↗ |
| Web sockets ⓘ | Off On |
| Always On ⓘ | Upgrade to enable ↗ |
| Managed Pipeline Version | Integrated Classic |
| HTTP Version | 1.1 2.0 |

DEPLOYMENT

- Quickstart
- Deployment credentials
- Deployment slots
- Deployment options
- Deployment Center (Preview)

SETTINGS



- Application settings**
- Authentication / Authorization
- Application Insights



|  Dev / Test For less demanding workloads |  Production For most production workloads |  Isolated Advanced networking and |
|--|---|---|
|--|---|---|

Recommended pricing tiers

| | | |
|---|--|--|
| F1 Shared infrastructure 1 GB memory 60 minutes/day compute Free | D1 Shared infrastructure 1 GB memory 240 minutes/day compute 8.11 EUR/Month (Estimated) | B1 100 total ACU 1.75 GB memory A-Series compute equivalent 27.60 EUR/Month (Estimated) |
|---|--|--|



[See additional options](#)

| | |
|---|--|
| <p>Included features</p> <p>Every app hosted on this App Service plan will have access to these features:</p> <div style="border: 1px solid #ccc; padding: 5px;">  Custom domains Configure and purchase custom domain names. </div> | <p>Included hardware</p> <p>Every instance of your App Service plan will include the following hardware configuration:</p> <div style="border: 1px solid #ccc; padding: 5px;">  Azure Compute Units (ACU) Dedicated compute resources used to run applications deployed on this Service Plan. Learn more </div> |
|---|--|

|  Dev / Test For less demanding workloads |  Production For most production workloads |  Isolated Advanced networking and |
|--|---|---|
|--|---|---|

Recommended pricing tiers

| | | |
|---|--|--|
| S1 100 total ACU 1.75 GB memory A-Series compute equivalent 37.57 EUR/Month (Estimated) | P1V2 210 total ACU 3.5 GB memory Dv2-Series compute equivalent 125.44 EUR/Month (Estimated) | P2V2 420 total ACU 7 GB memory Dv2-Series compute equivalent 250.95 EUR/Month (Estimated) |
| P3V2 840 total ACU 14 GB memory Dv2-Series compute equivalent 501.90 EUR/Month (Estimated) | | |

|  Dev / Test For less demanding workloads |  Production For most production workloads |
|--|---|
|--|---|

Recommended pricing tiers

| | | |
|--|--|---|
| I1 1x cores 3.5 GB memory Dv2-Series compute 188.16 EUR/Month (Estimated) | I2 2x cores 7 GB memory Dv2-Series compute 376.39 EUR/Month (Estimated) | I3 4x cores 14 GB memory Dv2-Series compute 752.85 EUR/Month (Estimated) |
|--|--|---|



cloudcomrade01 - Authentication / Authorization

App Service

Search (Ctrl+/)

Save Discard

- Overview
- Activity log
- Access control (IAM)
- Tags
- Diagnose and solve problems

DEPLOYMENT

- Quickstart
- Deployment credentials
- Deployment slots
- Deployment options
- Deployment Center (Preview)

SETTINGS

- Application settings
- Authentication / Authorization

Authentication / Authorization



Anonymous access is enabled on the App Service app. Users will not be prompted for login.

App Service Authentication

Off On

Save Discard

Authentication / Authorization

 To enable Authentication / Authorization please ensure all your custom domains have corresponding SSL bindings .net





App Service Authentication

Off On

Action to take when request is not authenticated

Log in with Facebook

Authentication Providers

| | |
|--|----------------|
|  Azure Active Directory | Not Configured |
|  Facebook | Not Configured |
|  Google | Not Configured |
|  Twitter | Not Configured |
|  Microsoft | Not Configured |

Advanced Settings

Token Store Off On

ALLOWED EXTERNAL REDIRECT URLS

Save Discard

Authentication / Authorization

i To enable Authentication / Authorization please ensure all your custom domains have corresponding SSL





App Service Authentication

Off On

Action to take when request is not authenticated

Log in with Facebook

Authentication Providers

| |
|--|
|  Azure Active Directory Configured (Express Mode : Create) |
|  Facebook Not Configured |
|  Google Not Configured |
|  Twitter Not Configured |
|  Microsoft Not Configured |

Advanced Settings

Token Store Off On

ALLOWED EXTERNAL REDIRECT URLS



[Application logs](#)
[Web server logs](#)
|| Pause
▶ Start
✕ Clear

Application logs

```

Connecting...
2018-11-22T10:02:35 Welcome, you are now connected to log-streaming service.
#Software: Microsoft Internet Information Services 8.0
#Fields: date time s-sitename cs-method cs-uri-stem cs-uri-query s-port cs-username c-ip cs(User-Agent) cs(Cookie) cs(Re
win32-status sc-bytes cs-bytes time-taken
2018-11-22 10:02:27 HANDSONAZURE01 GET / X-ARR-LOG-ID=a1d487c8-fcde-4551-acb8-bc93f36c5cd6 443 - 83.31.147.112 Mozilla/5
Kit/537.36+(KHTML,+like+Gecko)+Chrome/70.0.3538.102+Safari/537.36 - https://portal.azure.com/ handsonazure01.azurewebsit
2018-11-22 10:02:40 HANDSONAZURE01 GET / X-ARR-LOG-ID=21853864-ab71-4ece-b614-ba6a076188e4 443 - 83.31.147.112 Mozilla/5
Kit/537.36+(KHTML,+like+Gecko)+Chrome/70.0.3538.102+Safari/537.36 ARRaffinity=351922e8227d230d303a550eebfd4ae42ceb4a65c5
re.com/ handsonazure01.azurewebsites.net 304 0 0 316 1353 15
2018-11-22T10:05:35 No new trace in the past 1 min(s).
2018-11-22T10:06:35 No new trace in the past 2 min(s).

```

Chapter 02: Azure WebJobs

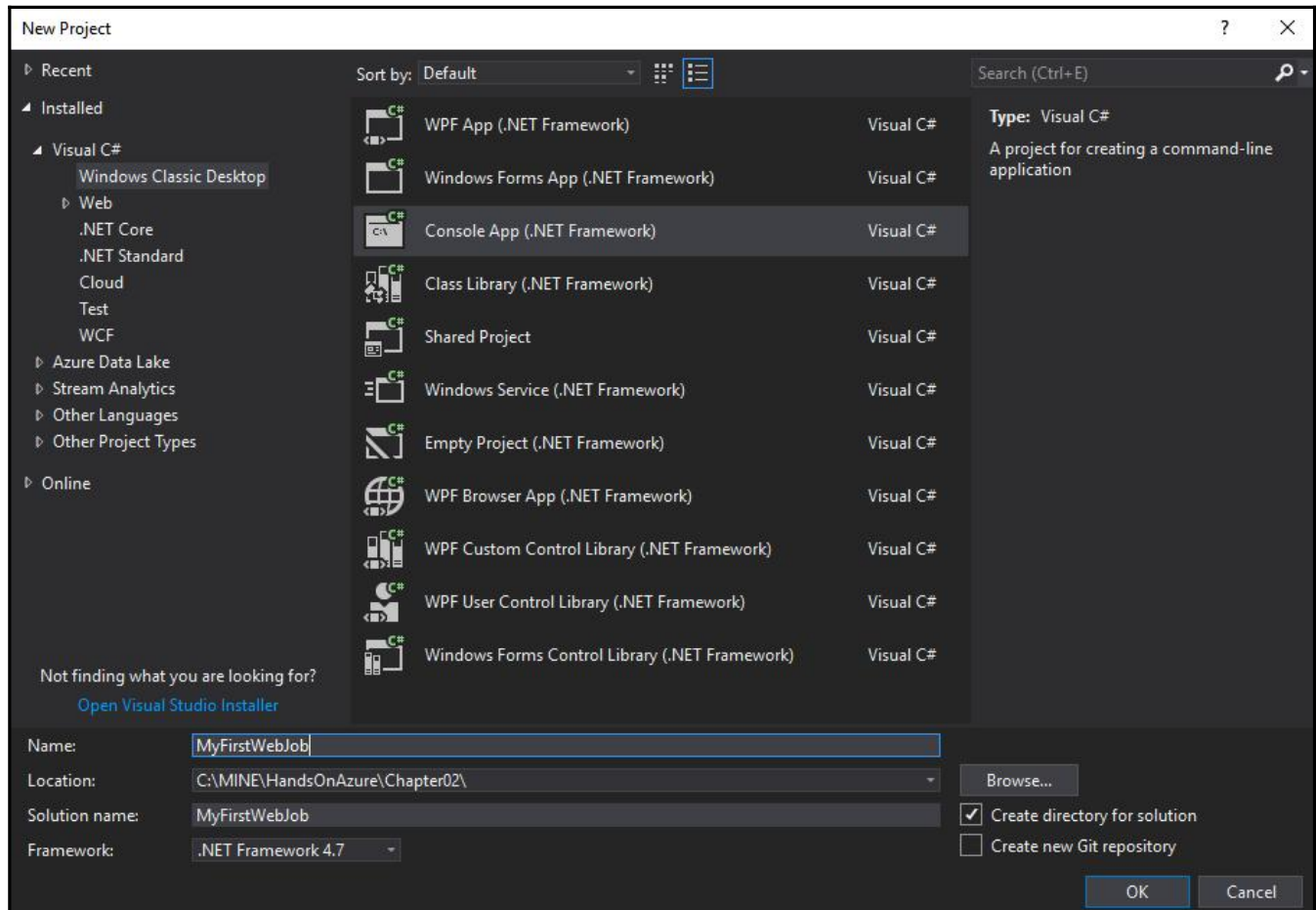

Home > Resource groups > handsonazure-rg > handsonazure02 - WebJobs

handsonazure02 - WebJobs

App Service

Search (Ctrl+/)

- SSL settings
- Networking
- Scale up (App Service plan)
- Scale out (App Service plan)
- WebJobs**
- Push

+ Add Refresh Logs Delete Properties

WebJobs

WebJobs provide an easy way to run scripts or programs as background

| NAME | TYPE | STATUS |
|--|------|--------|
| You haven't added any WebJobs. Click ADD to get started. | | |

Add WebJob

handsonazure02

* Name ⓘ

* File Upload

Type ⓘ

Scheduled WebJob will be executed based on provided CRON expression. Click here to learn more about CRON Expression.

Triggers ⓘ

* CRON Expression ⓘ

✕
Add WebJob
handsonazure02

*** Name** ⓘ

*** File Upload**

📁

Type ⓘ

▼

i Scheduled WebJob will be executed based on provided CRON expression. [Click here to learn more about CRON Expression.](#)

Triggers ⓘ

▼

*** CRON Expression** ⓘ

✔

Home > Resource groups > handsonazure-rg > handsonazure02 - WebJobs

handsonazure02 - WebJobs
App Service

⏪

+ Add
🔄 Refresh
📄 Logs
🗑️ Delete
⚙️ Properties

- ▼ Application insights
- 📁 Managed service identity (Pr...
- 📁 Backups
- 📁 Custom domains
- 📁 SSL settings
- ↔️ Networking
- 📈 Scale up (App Service plan)

WebJobs

WebJobs provide an easy way to run scripts or programs as background processes in the context of your app.

| NAME | TYPE | STATUS | SCHEDULE |
|---------------|-----------|--------|---------------|
| MyFirstWebJob | Triggered | Ready | 0 */1 * * * * |

Microsoft Azure WebJobs 1 Functions

WebJobs / MyFirstWebJob

WebJob Run Details MyFirstWebJob

Running 3 minutes ago (less than 1ms running time)
Run ID: 201806161633527138

[Toggle Output](#)

Refreshed a moment ago, [refresh](#) or [download](#)

```
[06/16/2018 16:33:52 > 8fbdbc: SYS INFO] Status changed to Initializing
[06/16/2018 16:33:52 > 8fbdbc: SYS INFO] Run script 'MyFirstWebJob.exe' with script host - 'WindowsScriptHost'
[06/16/2018 16:33:52 > 8fbdbc: SYS INFO] Status changed to Running
[06/16/2018 16:33:52 > 8fbdbc: INFO] Current date and time is: 2018-6-16 Saturday 16:33:52
```

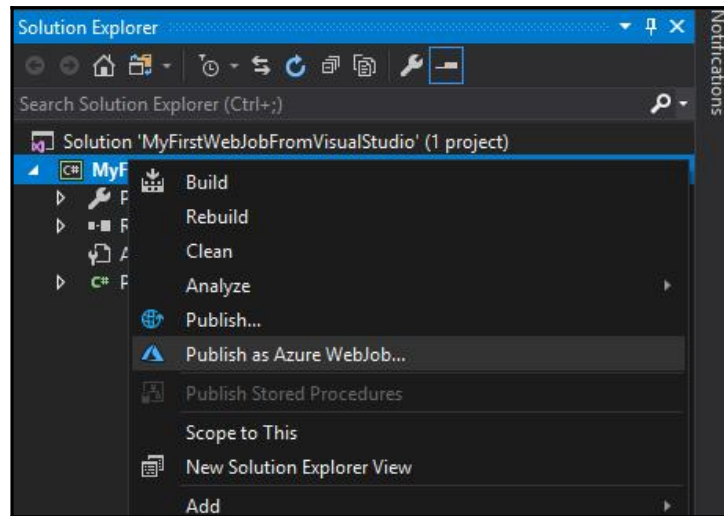

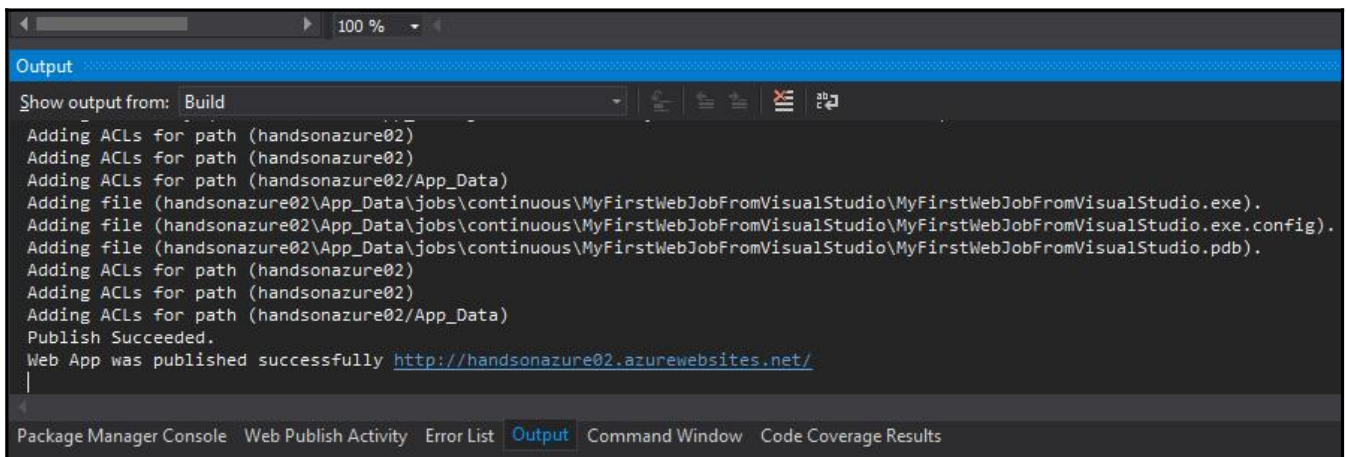
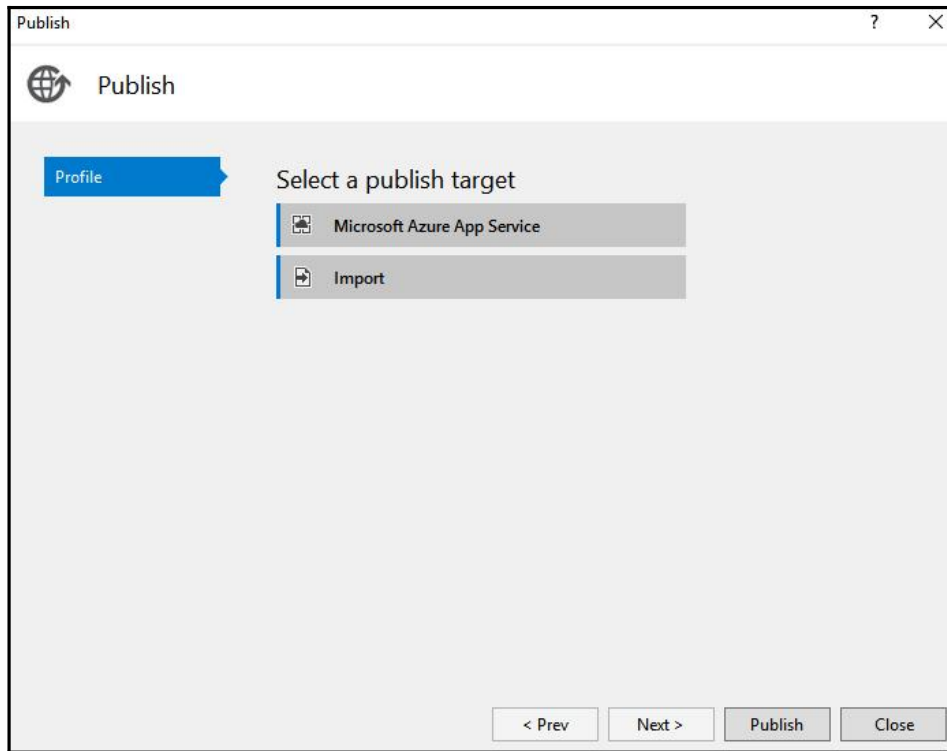

Home > Resource groups > handsonazure-rg > handsonazure02 - WebJobs

handsonazure02 - WebJobs

App Service

Search (Ctrl+/) << + Add Refresh Logs Delete Start Properties

- Deployment slots
- Deployment options
- Deployment Center (Preview)

SETTINGS

- Application settings
- Authentication / Authorization
- Application Insights

WebJobs

WebJobs provide an easy way to run scripts or programs as background processes in the context of your app.

| NAME | TYPE | STATUS | SCHEDULE |
|-------------------------------|------------|-----------------|---------------|
| MyFirstWebJob | Triggered | Running | 0 */1 * * * * |
| MyFirstWebJobFromVisualStudio | Continuous | Pending Restart | n/a |

NuGet: MyFirstWebJobWebJobsSDK Program.cs*

NuGet Package Manager: MyFirstWebJobWebJobsSDK

Microsoft.Azure.WebJobs Include prerelease Package source: nuget.org

Microsoft.Azure.WebJobs by Microsoft, 4,84M downloads v2.2.0

Microsoft.Azure.WebJobs.Host is a library for writing WebJobs in Microsoft Azure. The host is a container where all the functions in your program can execute. This package contains the runtime assemblies for Microsoft.Azure.Web...

Microsoft.Azure.WebJobs.ServiceBus by Microsoft, 1,31M downloads v2.2.0

Microsoft.Azure.WebJobs.ServiceBus is a library for writing Microsoft Azure WebJobs using Service Bus. This package contains the runtime assemblies for Microsoft.Azure.WebJobs.ServiceBus.

Version: Latest stable 2.2.0 Install

Options

```

NuGet: MyFirstWebJobWebJobsSDK  Program.cs
MyFirstWebJobWebJobsSDK
1  using Microsoft.Azure.WebJobs;
2
3  namespace MyFirstWebJobWebJobsSDK
4  {
5      class Program
6      {
7          static void Main()
8          {
9              var config = new JobHostConfiguration();
10             var host = new JobHost(config);
11             host.RunAndBlock();
12         }
13     }
14 }
15

```

Exception Unhandled

System.InvalidOperationException: 'Microsoft Azure WebJobs SDK 'Dashboard' connection string is missing or empty. The Microsoft Azure Storage account connection string can be set in the following ways:
1. Set the connection string named 'AzureWebJobsDashboard' in the connectionStrings section of the .config file in the following format <add name="AzureWebJobsDashboard" connectionString="DefaultEndpointsProtocol=http|https;AccountName=NAME;AccountKey=KEY" />, or
2. Set the environment variable named 'AzureWebJobsDashboard', or
3. Set corresponding property of JobHostConfiguration.'

[View Details](#) | [Copy Details](#)

▶ [Exception Settings](#)

```

C:\MINE\HandsOnAzure\Chapter02\MyFirstWebJobWebJobsSDK\MyFirstWebJobWebJobsSDK\bin\Debug\MyFirstWebJobWebJobsSDK.exe
No job functions found. Try making your job classes and methods public. If you're using binding extensions (e.g. Service Bus, Timers, etc.) make sure you've called the registration method for the extension(s) in your startup code (e.g. config.UseServiceBus(), config.UseTimers(), etc.).
ServicePointManager.DefaultConnectionLimit is set to the default value of 2. This can limit the connection throughput to services like Azure Storage. For more information, see https://aka.ms/webjobs-connections.
Job host started

```

```

C:\MINE\HandsOnAzure\Chapter02\MyFirstWebJobWebJobsSDK\MyFirstWebJobWebJobsSDK\bin\Debug\MyFirstWebJobWebJobsSDK.exe
Found the following functions:
MyFirstWebJobWebJobsSDK.Manual.ManualFunction
ServicePointManager.DefaultConnectionLimit is set to the default value of 2. This can limit the connection throughput to services like Azure Storage. For more information, see https://aka.ms/webjobs-connections.
Executing 'Manual.ManualFunction' (Reason='This function was programmatically called via the host APIs.', Id=75f5913e-e631-457e-991c-51ac4ef972d2)
Received message: Hello world!
Executed 'Manual.ManualFunction' (Succeeded, Id=75f5913e-e631-457e-991c-51ac4ef972d2)
Job host started

```

```

C:\MINE\HandsOnAzure\Chapter02\MyFirstWebJobWebJobsSDK\MyFirstWebJobWebJobsSDK\bin\Debug\MyFirstWebJobWebJobsSDK.exe
Found the following functions:
MyFirstWebJobWebJobsSDK.Manual.ManualFunction
MyFirstWebJobWebJobsSDK.Timer.TimerFunction
ServicePointManager.DefaultConnectionLimit is set to the default value of 2. This can limit the connection throughput to
services like Azure Storage. For more information, see https://aka.ms/webjobs-connections.
Executing 'Manual.ManualFunction' (Reason='This function was programmatically called via the host APIs.', Id=aef3a9ed-5f
44-4064-a92b-37efd0c3b220)
Received message: Hello world!
Executed 'Manual.ManualFunction' (Succeeded, Id=aef3a9ed-5f44-4064-a92b-37efd0c3b220)
The next 5 occurrences of the schedule will be:
17.06.2018 08:48:44
17.06.2018 08:48:45
17.06.2018 08:48:46
17.06.2018 08:48:47
17.06.2018 08:48:48
Job host started
Executing 'Timer.TimerFunction' (Reason='Timer fired at 2018-06-17T08:48:44.0109100+02:00', Id=a965d027-f64c-41fc-b0db-5
b1dd6915Faa)
Message triggered at 2018-06-17 08:48:44
Executed 'Timer.TimerFunction' (Succeeded, Id=a965d027-f64c-41fc-b0db-5b1dd6915faa)
Executing 'Timer.TimerFunction' (Reason='Timer fired at 2018-06-17T08:48:45.0008161+02:00', Id=cd6eb912-05c0-40be-8d9f-e
90d69e93f29)
Message triggered at 2018-06-17 08:48:45
Executed 'Timer.TimerFunction' (Succeeded, Id=cd6eb912-05c0-40be-8d9f-e90d69e93f29)

```

Home > Resource groups > handsonazure-rg > handsonazure02 - WebJobs

handsonazure02 - WebJobs

App Service

Search (Ctrl+/) << + Add Refresh Logs Delete Stop Properties

Deployment Center (Preview)

SETTINGS

- Application settings
- Authentication / Authorization
- Application Insights
- Managed service identity (Pr...
- Backups

WebJobs

WebJobs provide an easy way to run scripts or programs as background processes in the context of your app.

| NAME | TYPE | STATUS | SCHEDULE |
|-------------------------------|------------|-----------------|---------------|
| MyFirstWebJob | Triggered | Running | 0 */1 * * * * |
| MyFirstWebJobFromVisualStudio | Continuous | Pending Restart | n/a |
| MyFirstWebJobWebJobsSDK | Continuous | Running | n/a |

Continuous WebJob Details MyFirstWebJobNodeJs

Pending restart
Run command: run.js

[Toggle Output](#)

Refreshed a moment ago, [refresh](#) or [download](#)

```
[06/17/2018 12:53:41 > ffc1d1: SYS INFO] Detected WebJob file/s were updated, refreshing WebJob
[06/17/2018 12:53:41 > ffc1d1: SYS INFO] Status changed to Starting
[06/17/2018 12:53:41 > ffc1d1: SYS INFO] WebJob singleton setting is False
[06/17/2018 12:53:41 > ffc1d1: SYS INFO] Run script 'run.js' with script host - 'NodeScriptHost'
[06/17/2018 12:53:41 > ffc1d1: SYS INFO] Status changed to Running
[06/17/2018 12:53:42 > ffc1d1: INFO] Hello, this is my first WebJob in Node.js!
[06/17/2018 12:53:42 > ffc1d1: SYS INFO] Status changed to Success
[06/17/2018 12:53:42 > ffc1d1: SYS INFO] Process went down, waiting for 60 seconds
[06/17/2018 12:53:42 > ffc1d1: SYS INFO] Status changed to PendingRestart
```

The screenshot shows the Visual Studio IDE with the Azure portal extension. The left sidebar displays the Azure resource tree under 'AZURE' > 'APP SERVICE'. The selected resource is 'NodeJS', and a context menu is open with options 'Open in Portal' and 'Refresh'. The main editor area shows a code editor with a file named 'JS run.js' containing the following JavaScript code:

```
1 var myFirstWebJob = function() {
2     console.log("Hello, this is my first WebJob in Node.js!");
3 };
4
5 myFirstWebJob();
```

Microsoft Azure

Home > handsonazure-euw-rg - WebJobs

handsonazure-euw-rg - WebJobs

App Service

Search (Ctrl+ /)

+ Add Refresh Properties Logs

Continuous and scheduled CRON webjobs require Add

WebJobs

WebJobs provide an easy way to run scripts or

| NAME | TYPE |
|--------|-----------|
| NodeJS | Triggered |

Chapter 03: Deploying Web Applications as Containers

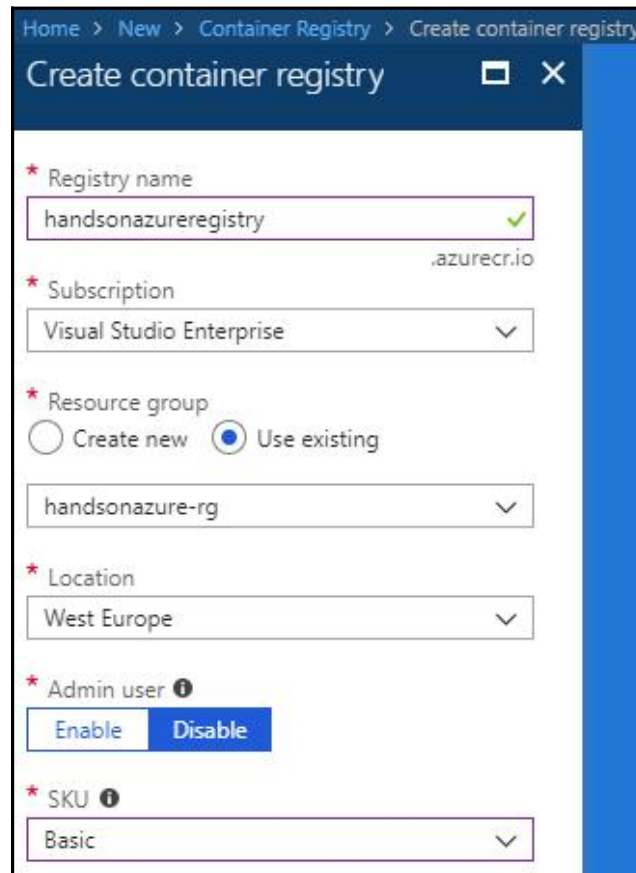

```
$ docker images
REPOSITORY          TAG                 IMAGE ID            CREATED             SIZE
handsonazurehello   latest             455a5d8b2549      About an hour ago  132MB
python              2.7-slim          d0d1b97dd328      2 weeks ago       120MB
hello-world         latest            e38bc07ac18e      2 months ago      1.85kB
```

Login server
handsonazureregistry.azurecr.io

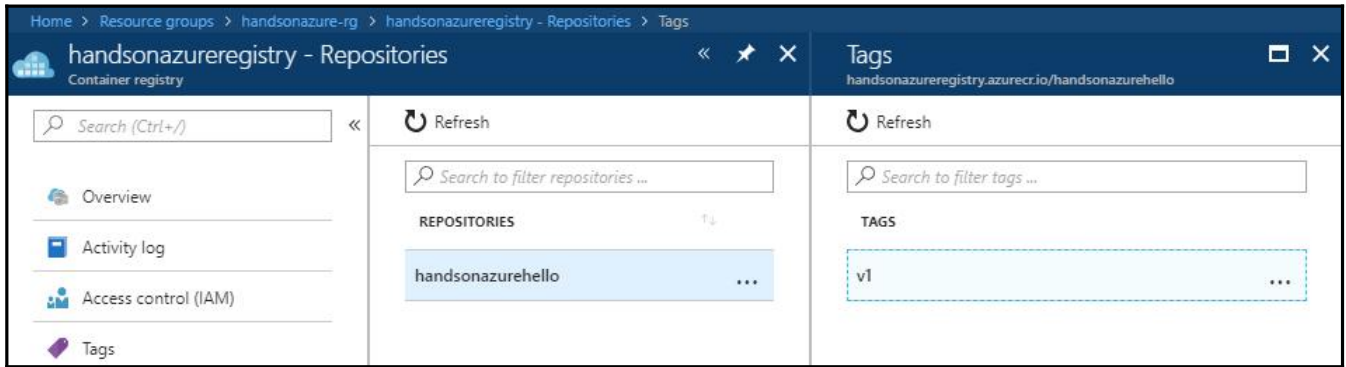

Create Kubernetes cluster

Basics

Networking

Monitoring

Tags

Review + create

Azure Kubernetes Service (AKS) manages your hosted Kubernetes environment, making it quick and easy to deploy and manage containerized applications without container orchestration expertise. It also eliminates the burden of ongoing operations and maintenance by provisioning, upgrading, and scaling resources on demand, without taking your applications offline. [Learn more about Azure Kubernetes Service](#)

PROJECT DETAILS

Select a subscription to manage deployed resources and costs. Use resource groups like folders to organize and manage all your resources.

* Subscription ⓘ

Visual Studio Enterprise



* Resource group ⓘ

Create new Use existing

CLUSTER DETAILS

* Kubernetes cluster name ⓘ

* Region ⓘ

West Europe



* Kubernetes version ⓘ

1.10.3



* DNS name prefix ⓘ

AUTHENTICATION

* Service principal ⓘ

(new) default service principal

[Configure service principal](#)

Create Kubernetes cluster

 Validation passed

Basics Networking Monitoring Tags Review + create

BASICS

| | |
|-------------------------|--------------------------|
| Subscription | Visual Studio Enterprise |
| Resource group | handsonazure-rg |
| Kubernetes cluster name | HandsOnCluster |
| Region | West Europe |
| Kubernetes version | 1.10.3 |
| DNS name prefix | HandsOnCluster |
| Node count | 1 |
| Node size | Standard_A1_v2 |

MONITORING

| | |
|-----------------------------|---|
| Enable container monitoring | Yes |
| Log Analytics workspace | (new) DefaultWorkspace-94f33c43-60b5-4042-ae74-51777f69f99a-WEU |

NETWORKING

| | |
|--------------------------|-------|
| HTTP application routing | Yes |
| Network configuration | Basic |

MONITORING

| | |
|-----------------------------|---|
| Enable container monitoring | Yes |
| Log Analytics workspace | (new) DefaultWorkspace-94f33c43-60b5-4042-ae74-51777f69f99a-WEU |



127.0.0.1:8001/#!/overview?namespace=default

kubernetes Search

Overview

Cluster

- Namespaces
- Nodes
- Persistent Volumes
- Roles
- Storage Classes

Namespace

default

Overview

Workloads

- Cron Jobs
- Daemon Sets
- Deployments
- Jobs
- Pods
- Replica Sets
- Replication Controllers

Deployments

| Name | Labels | Pods | Age |
|------------------------|-----------------------------|-------|------------|
| handsonazurehello-back | app: handsonazurehello-back | 1 / 1 | 53 minutes |
| handsonazurehello | app: handsonazurehello | 0 / 1 | 58 minutes |

Pods

| Name | Node | Status | Restarts | Age |
|---|--------------------------|----------------------------|----------|------------|
| handsonazurehello-786bbcb479-jlv8z | aks-agentpool-31829077-1 | Waiting: ContainerCreating | 0 | 16 seconds |
| handsonazurehello-back-54d8bc4d65-q2db4 | aks-agentpool-31829077-0 | Running | 0 | 53 minutes |

Replica Sets

| Name | Labels | Pods | Age |
|------------------------------|---|-------|------------|
| handsonazurehello-786bbcb479 | app: handsonazurehello pod-template-hash: 3426676035 | 0 / 1 | 16 seconds |
| handsonazurehello-6bd5b4b7cd | app: handsonazurehello pod-template-hash: 2681606378 | 0 / 0 | 53 minutes |

Home > Resource groups > handsonazure-rg > HandsOnCluster - Scale

HandsOnCluster - Scale
Kubernetes service

Search (Ctrl+/) Save Discard Refresh

Overview

Activity log

Access control (IAM)

Tags

SETTINGS

Upgrade

Scale

You can scale the number of nodes in your cluster to increase the total amount of cores and memory available for [Learn more about scaling your AKS cluster.](#)

Total cluster capacity

Cores 2 vCPUs

Memory 4 GB

2 x Standard A1 v2 (1 vcpu, 2 GB memory)

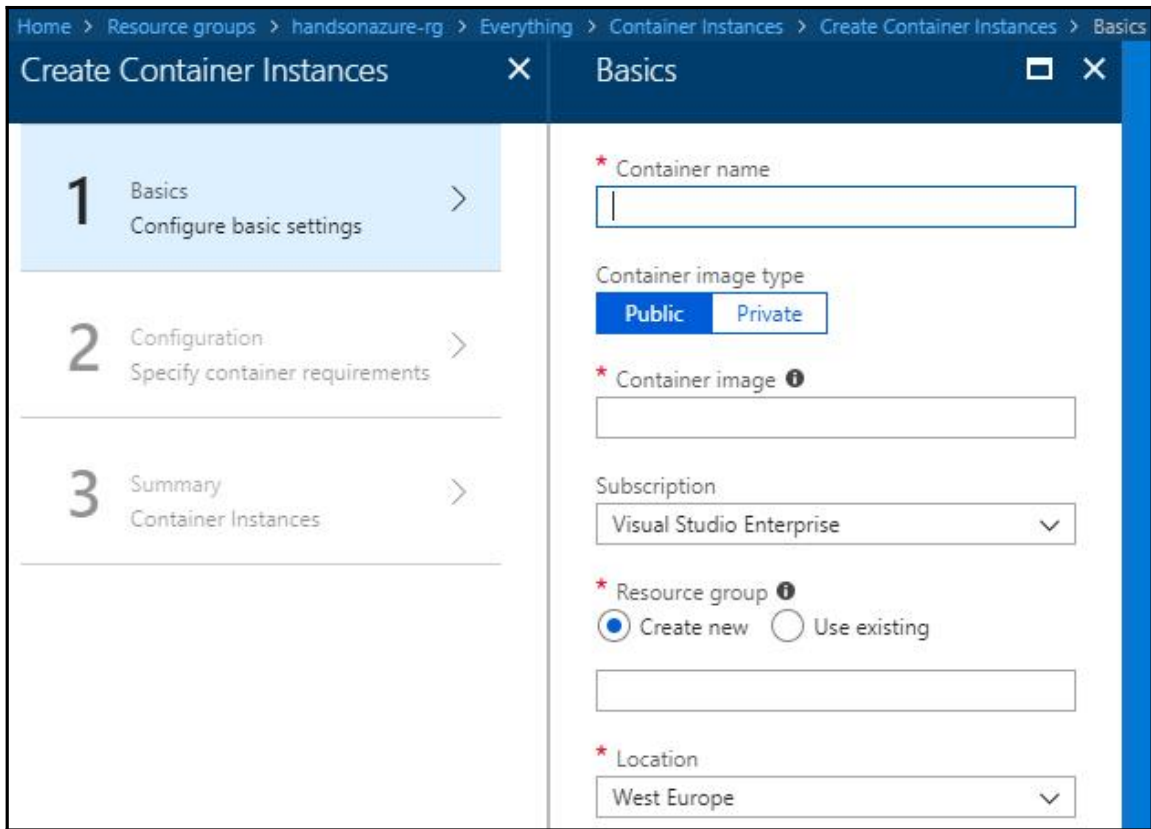

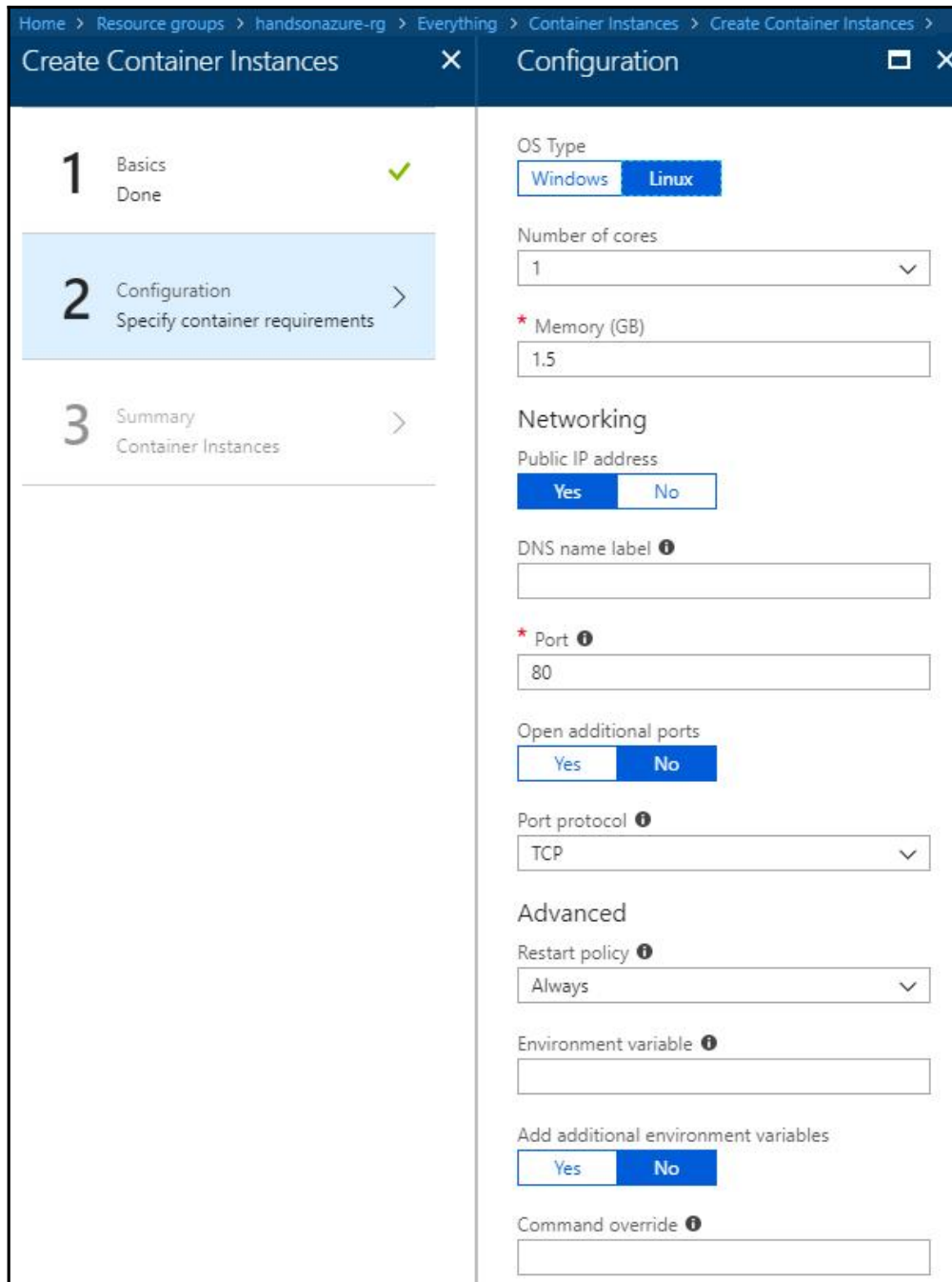

* OS **Windows** Linux Docker

Home > App Services > Web > Web App > Web App

Web App

Create

* App name
handsonazurecontainer ✓
azurewebsites.net

* Subscription
Visual Studio Enterprise

* Resource Group ⓘ
 Create new Use existing
handsonazure-rg

* OS **Windows** Linux **Docker**

* App Service plan/Location
handsonazure-containers-appser... >

* Configure container
appsvc/sample-hello-world:latest >

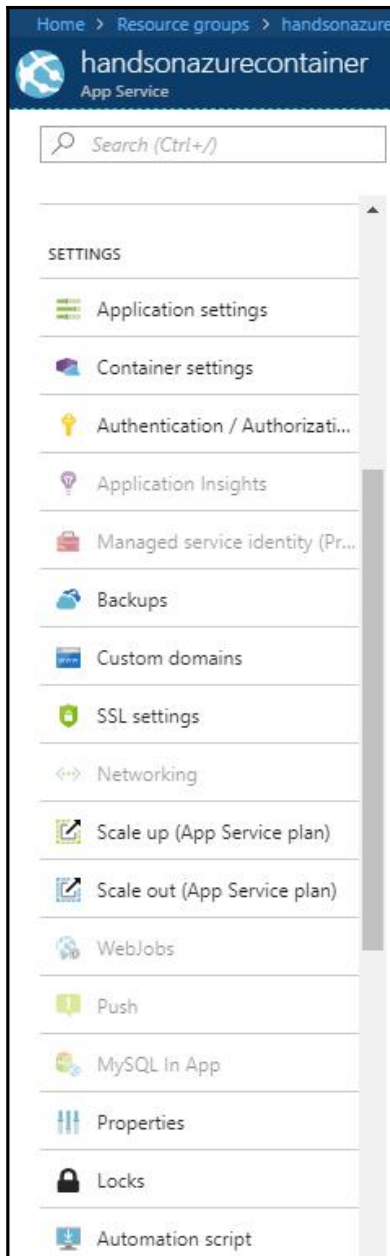

Home > Resource groups > handsonazure-rg > handsonazurecontainer - Container settings

handsonazurecontainer - Container settings

App Service

Search (Ctrl+/)

SETTINGS

- Application settings
- Container settings**
- Authentication / Authorizati...
- Application Insights
- Managed service identity (Pr...
- Backups
- Custom domains
- SSL settings
- Networking
- Scale up (App Service plan)
- Scale out (App Service plan)
- WebJobs
- Push
- MySQL In App

Single Container Docker Compose (Preview) Kubernetes (Preview)

Container Settings

Bring your own Docker formatted container images and easily deploy and run them at

Image source

Azure Container Registry Docker Hub Private registry

Repository Access

Public Private

* Image and optional tag (eg 'image:tag')

appsvc/sample-hello-world:latest

Startup File

LOGS

```

2018_06_20_RD0003FF4690D8_docker.log:
2018-06-20 08:13:56.315 INFO - Issuing docker pull: imagename =appsvc/sample-hello-world:latest
2018-06-20 08:13:56.958 INFO - docker pull returned STDOUT>> latest: Pulling from appsvc/sample
Digest: sha256:9920cd0736facf89bad9345ae37dced9e0b8c15952ec997d9074235186b0e736
Status: Image is up to date for 10.0.5.3:13209/appsvc/sample-hello-world:latest

2018-06-20 08:13:57.044 INFO - Starting container for site
2018-06-20 08:13:57.045 INFO - docker run -d -p 54923:8080 --name handsonazurecontainer_1 -e WEB
WEBSITE_INSTANCE_ID=85f4a148b31bb55d61aae974feb6e3b55d4ada2e89de2339308ffa358dd3d5d2

```

```

LOGS
2018_06_20_RD0003FF4690D8_default_docker.log:
2018-06-20T08:36:17.592665319Z Documentation: http://aka.ms/webapp-linux
2018-06-20T08:36:17.592676519Z Dotnet quickstart: https://aka.ms/dotnet-qs
2018-06-20T08:36:17.592687720Z
2018-06-20T08:36:17.946630732Z Starting OpenBSD Secure Shell server: sshd.
2018-06-20T08:36:17.969196460Z Could not find .csproj or .dll. Using default.
2018-06-20T08:36:19.847903386Z Hosting environment: Production
2018-06-20T08:36:19.848115790Z Content root path: /defaulthome/hostingstart/
2018-06-20T08:36:19.848351395Z Now listening on: http://[::]:8080
2018-06-20T08:36:19.848512098Z Application started. Press Ctrl+C to shut down.

```

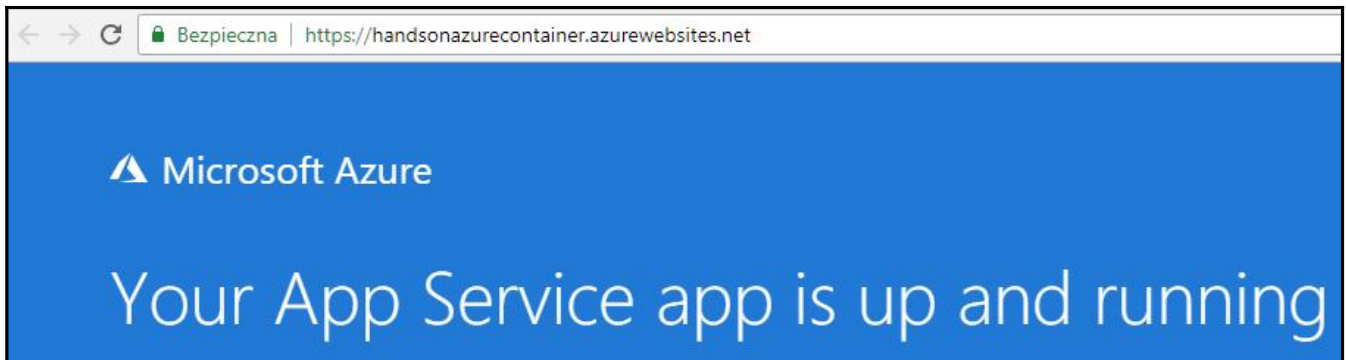

Image source

[Azure Container Registry](#) [Docker Hub](#) [Private registry](#)

* Registry
handsonazureregistry

* Image
handsonazure-aci

* Tag
v2

Startup File

LOGS

```
2018_06_25_RD0003FF4690D8_default_docker.log:
2018-06-25T06:39:58.871468713Z listening on port 80

2018_06_25_RD0003FF4690D8_docker.log:
2018-06-25 06:39:22.893 INFO - Recycling container because of AppFrameworkVersionChange and appFrameworkVersion = handsonazureregistry.azurecr.io/handsonazure-activ2
2018-06-25 06:39:52.922 INFO - Starting container for site
2018-06-25 06:39:52.927 INFO - docker run -d -p 48250:80 --name handsonazurecontainer_3 -e WEBSITE_SITE_NAME=handsonazurecontainer -e WEBSITE_AUTH_ENABLED=False
WEBSITE_INSTANCE_ID=85f4a148b31bb55d61aae974feb6e3b55d4ada2e89de2339308ffa358dd3d5d2 -e HTTP_LOGGING_ENABLED=1 handsonazureregistry.azurecr.io/handsonazure
2018-06-25 06:39:59.379 INFO - Container handsonazurecontainer_3 for site handsonazurecontainer initialized successfully.
```



Chapter 04: Distributed Applications and Microservices with Service Fabric

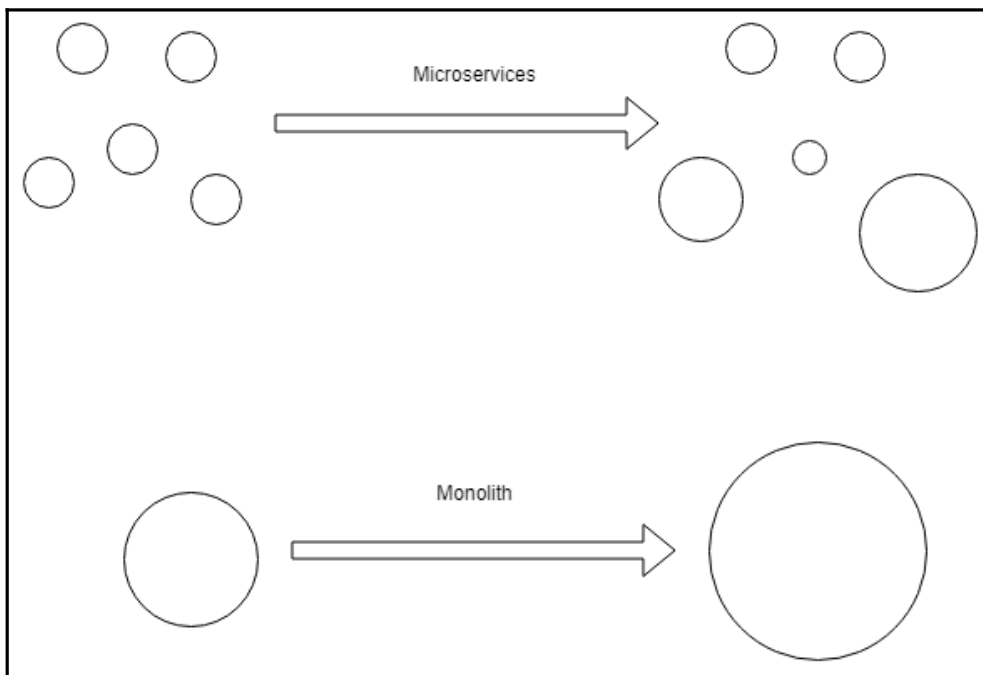
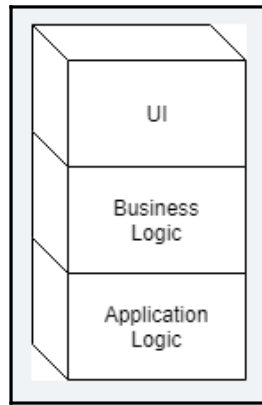

Home > New > Service Fabric Cluster > Create Service Fabric cluster > Basics

Create Service Fabric cluster

Basics

Basic cluster settings

- 1** Basics
Configure basic settings
- 2 Cluster configuration
Set up cluster configuration
- 3 Security
Configure security settings
- 4 Summary
Review, view template, create

* Cluster name ⓘ
handsonazure ✓
.westeurope.cloudapp.azure.com

* Operating system
UbuntuServer 16.04-LTS

Default VM credentials

* User name ⓘ
handsonazure ✓

* Password ⓘ
..... ⓘ ✓

* Confirm password
..... ⓘ ✓

* Subscription
Visual Studio Enterprise

* Resource group
 Create new Use existing
handsonazure-rg ✓

* Location
West Europe

Home > New > Service Fabric Cluster > Create Service Fabric cluster > Cluster configuration > Node type configuration

Create Service Fabric cluster ✕

- 1 Basics ✔
Done
- 2 Cluster configuration >
Set up cluster configuration
- 3 Security >
Configure security settings
- 4 Summary >
Review, view template, create

Cluster configuration ✕
Configure node types and diagnostics

Node types

Node types define the scale sets that will be used to manage your cluster. You specify between 1 and 3 in the portal. [Learn more about node types](#)

* Node type count ⓘ
 1 2 3

* Node type 1 (Primary)
Configure required settings >

+ Show optional settings

Node type configuration □ ✕
Node type 1 (Primary)

* Node type name ⓘ
 ✔

Durability tier ⓘ
 ▾

* Virtual machine size
Standard_D1_v2 >

Single node cluster ⓘ

Initial VM scale set capacity

○
|

Choosing less than 5 initial VM capacity for your primary node type will designate this cluster as a test cluster.

Custom endpoints ⓘ

Configure advanced settings ⓘ

Home > New > Service Fabric Cluster > Create Service Fabric cluster > Security > Key vault

Create Service Fabric cluster ✕

- 1 Basics ✔
Done
- 2 Cluster configuration ✔
Done
- 3 Security >
Configure security settings
- 4 Summary >
Review, view template, create

Security ✕
Configure cluster security settings

Configuration Type
 Basic Custom

In 'Basic' mode, a certificate will be created for you in the key vault of your choice. If you would like to use an existing certificate or would like additional certificate options, choose 'Custom' instead.

* Key vault
handsonazure-keyvault >

* Certificate name
 ✔

Key vault □ ✕
Pick a vault

+ Create a new vault

handsonazure-keyvault
West Europe

| NAME | TYPE | LOCATION |
|------------------------|---------------------------|-------------|
| front | Virtual machine scale set | West Europe |
| handsonazure | Service Fabric cluster | West Europe |
| handsonazure-keyvault | Key vault | West Europe |
| LB-handsonazure-front | Load balancer | West Europe |
| LBIP-handsonazure-0 | Public IP address | West Europe |
| sfdghandsonazure2006 | Storage account | West Europe |
| sflagshandsonazure8980 | Storage account | West Europe |
| VNet-handsonazure | Virtual network | West Europe |

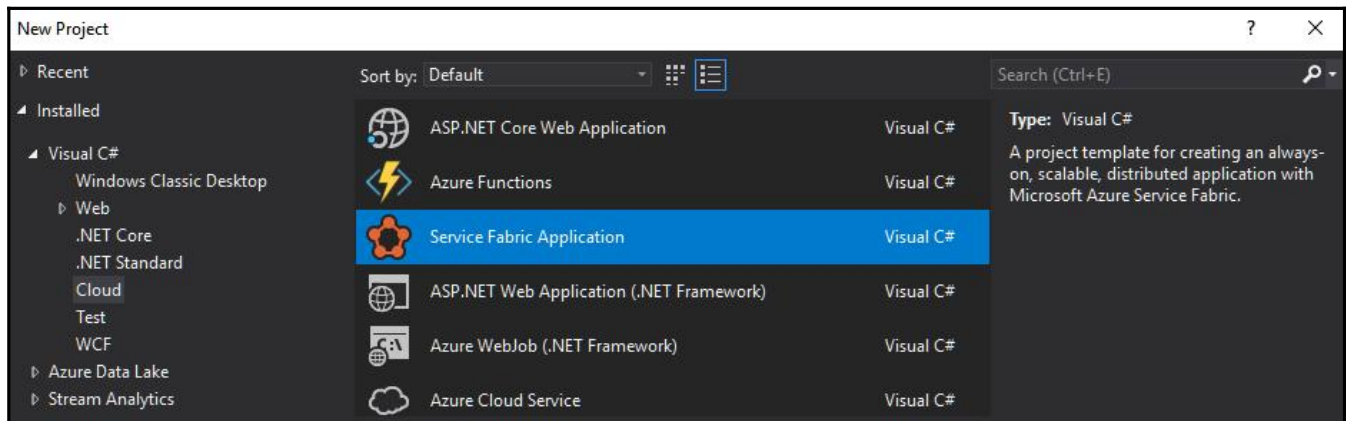
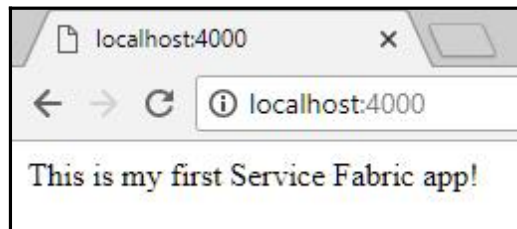

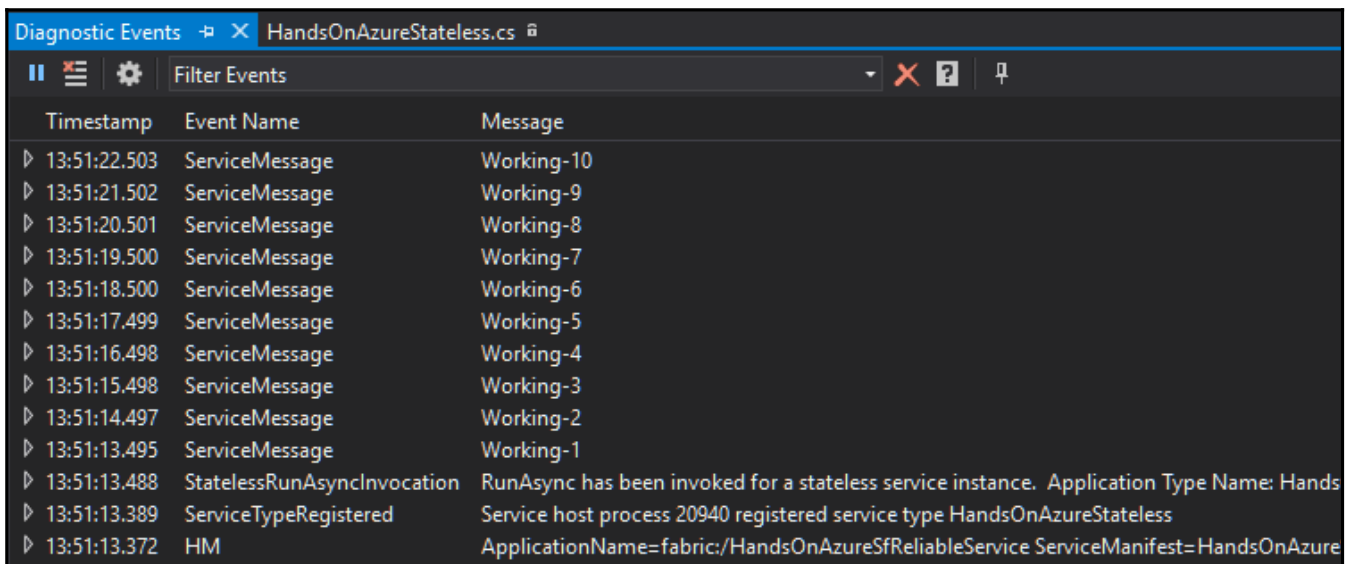
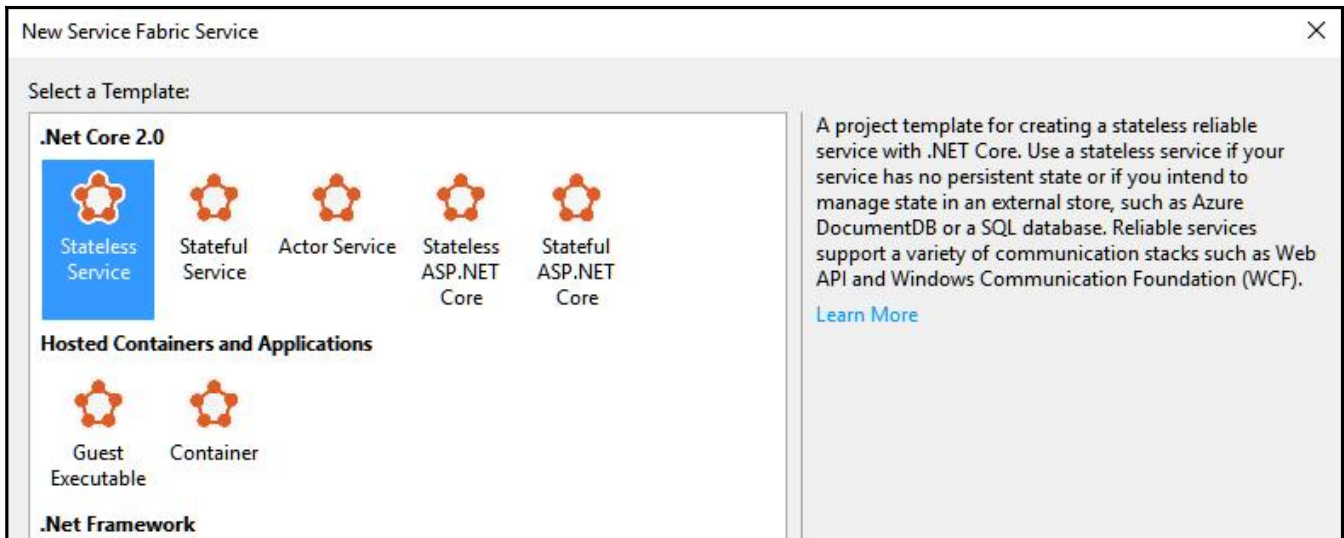

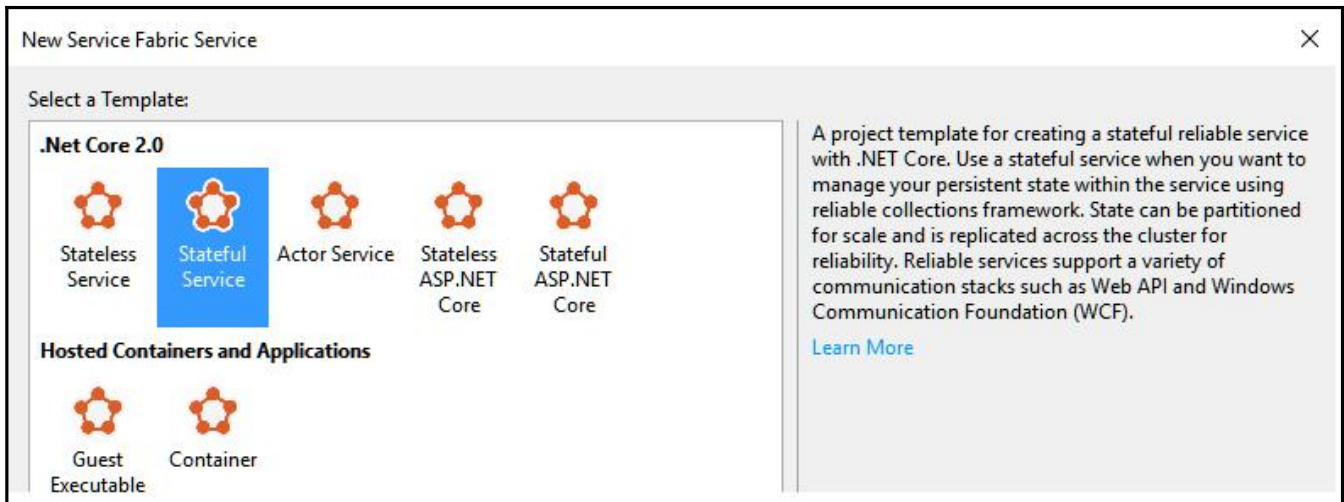

Diagnostic Events | HandsOnAzureStateful2.cs | ApplicationManifest.xml

Filter Events

| Timestamp | Event Name | Message |
|--------------|----------------|---------------------------|
| 14:41:13.718 | ServiceMessage | Current Counter Value: 16 |
| 14:41:12.921 | ServiceMessage | Working-24 |
| 14:41:12.713 | ServiceMessage | Current Counter Value: 15 |
| 14:41:11.921 | ServiceMessage | Working-23 |
| 14:41:11.709 | ServiceMessage | Current Counter Value: 14 |
| 14:41:10.918 | ServiceMessage | Working-22 |
| 14:41:10.703 | ServiceMessage | Current Counter Value: 13 |
| 14:41:09.917 | ServiceMessage | Working-21 |
| 14:41:09.684 | ServiceMessage | Current Counter Value: 12 |
| 14:41:08.916 | ServiceMessage | Working-20 |
| 14:41:08.678 | ServiceMessage | Current Counter Value: 11 |
| 14:41:07.915 | ServiceMessage | Working-19 |

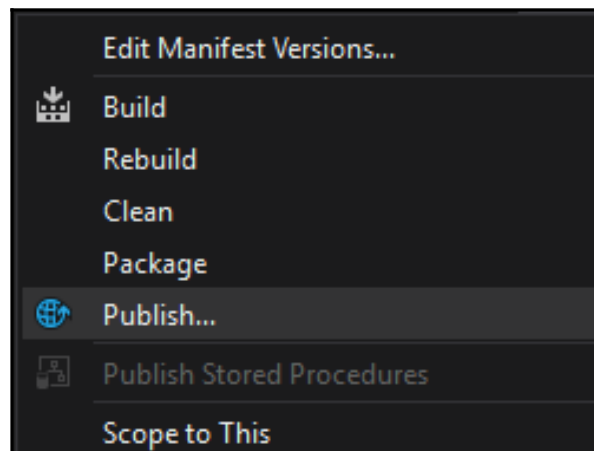

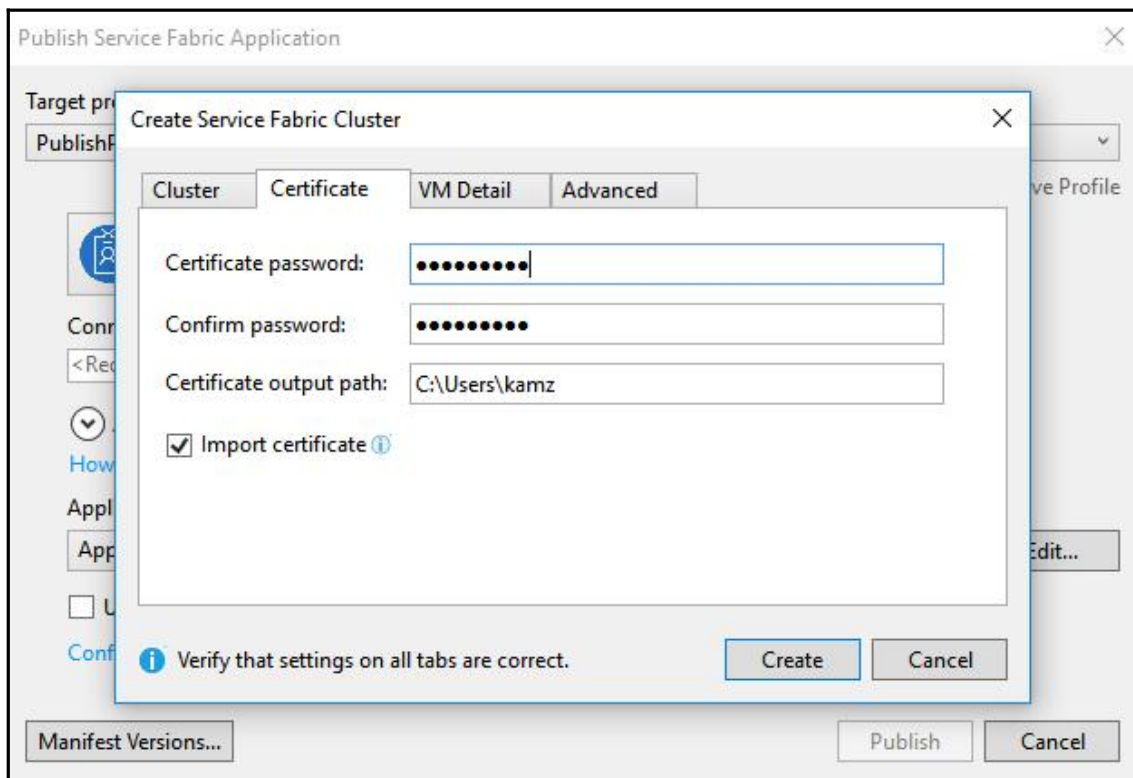
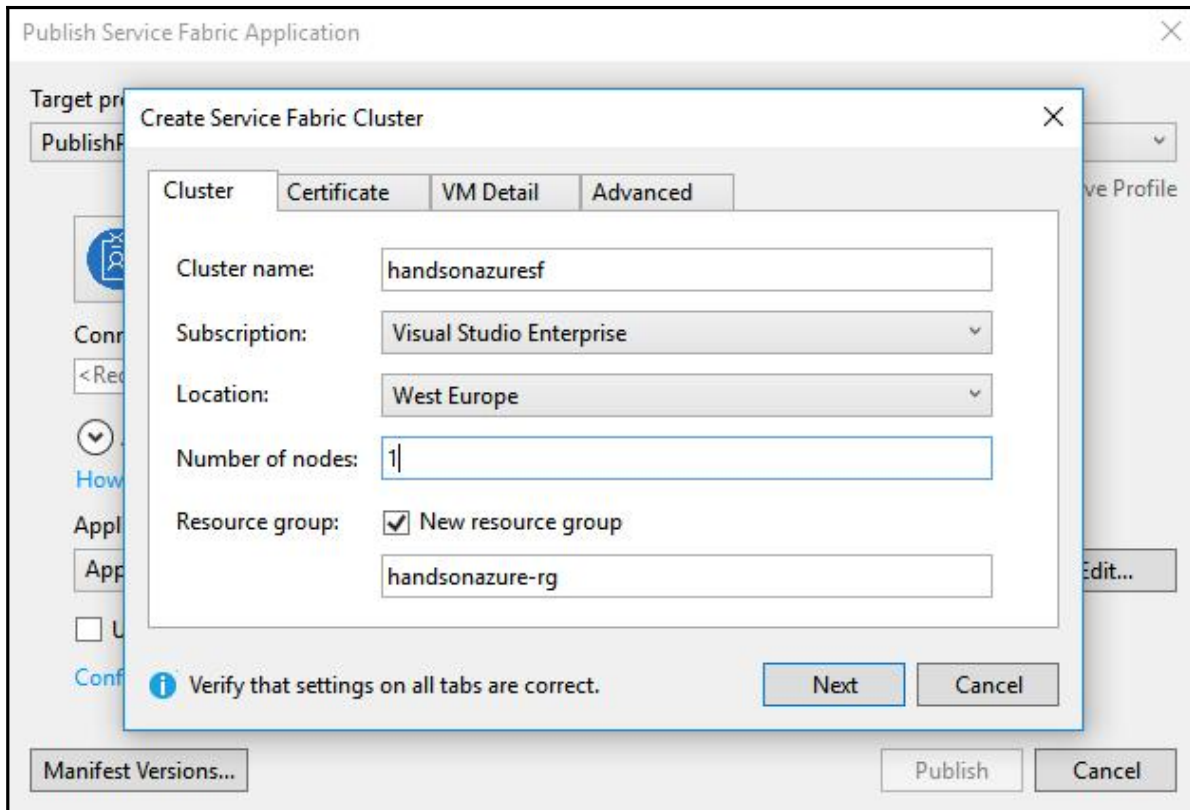

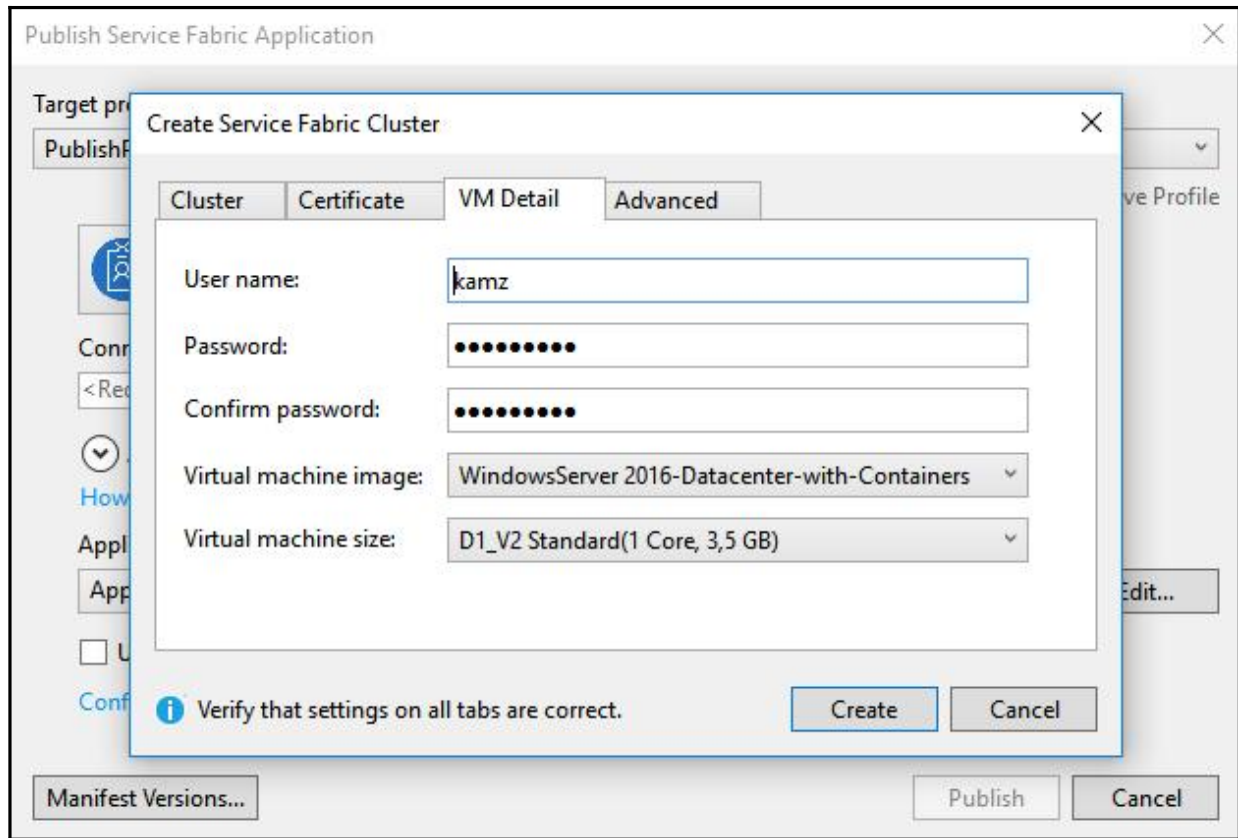

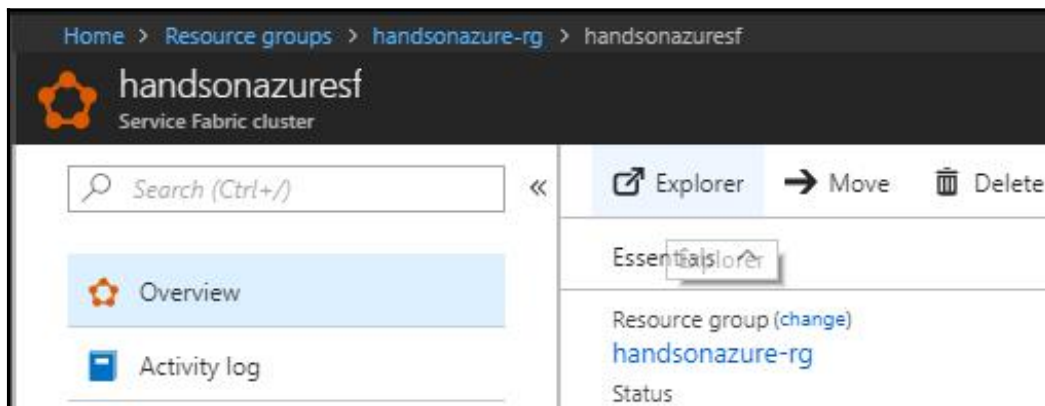
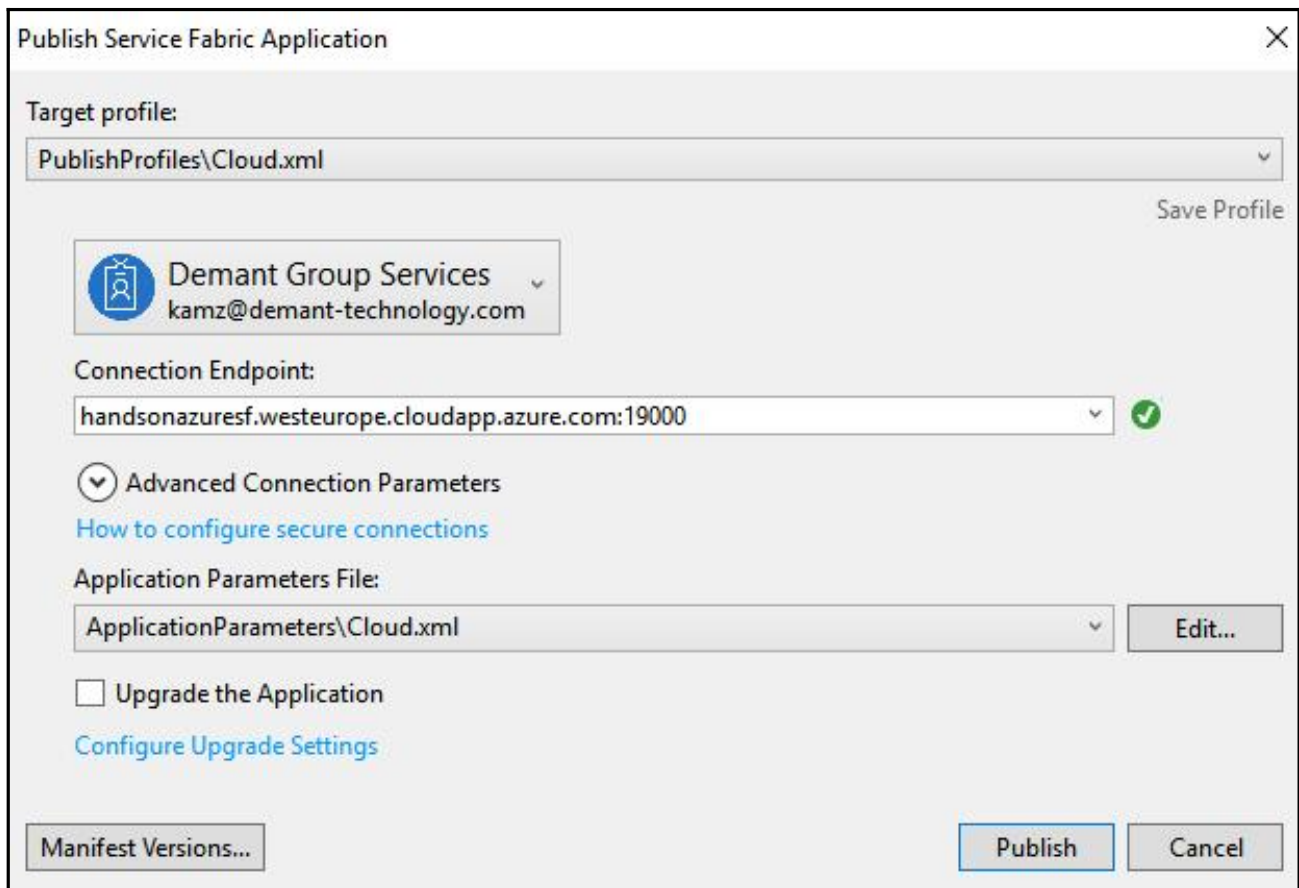

Microsoft Azure Service Fabric Explorer

Cluster <https://handsonazuresf.westeurope.cloudapp.azure.com>

ESSENTIALS DETAILS CLUSTER MAP METRICS MANIFEST

Cluster Health State: **Warning**

System Application Health State: **OK**

Healthy Seed Nodes: 1 (100%)

Upgrade Domains: 1

Fault Domains: 1

DASHBOARD

| | | | |
|---|--|---|---|
| <p>1 NODE</p> <p>ERROR: 0 WARNING: 0 HEALTHY: 1</p> | <p>1 APPLICATION</p> <p>ERROR: 0 WARNING: 1 HEALTHY: 0</p> | <p>2 SERVICES</p> <p>ERROR: 0 WARNING: 1 HEALTHY: 1</p> | <p>2 REPLICAS</p> <p>ERROR: 0 WARNING: 0 HEALTHY: 2</p> |
| | | <p>2 PARTITIONS</p> <p>ERROR: 0 WARNING: 1 HEALTHY: 1</p> | <p>UPGRADE IN PROGRESS</p> <p>0</p> |

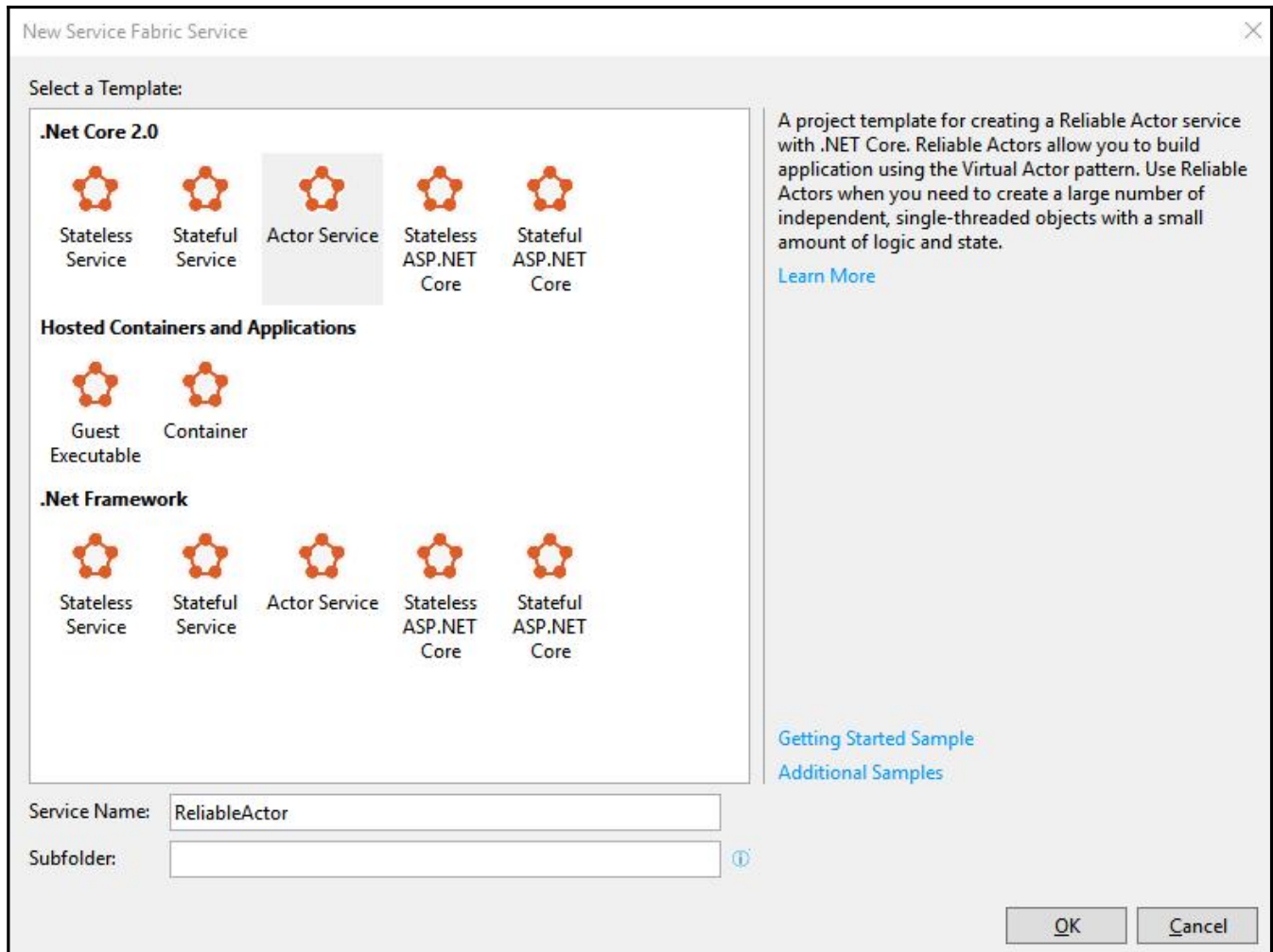

```
C:\Program Files\dotnet\dotnet.exe
Current count is: 0
Current count is: 1
Current count is: 2
Current count is: 3
Current count is: 4
Current count is: 5
Current count is: 6
Current count is: 7
Current count is: 8
```

localhost:19080/Explorer/index.html#/apptype/HandsOnAzureSfReliableServiceType/app/HandsOnAzureSfReliableService/service/HandsOnAzureSfRe

Microsoft Azure Service Fabric Explorer

OK Warning Error

Search Cluster

- Cluster
 - Applications
 - HandsOnAzureSfReliableServiceType
 - fabric/HandsOnAzureSfReliableService
 - fabric/HandsOnAzureSfReliableService/Ha...
 - fabric/HandsOnAzureSfReliableService/Ha...
 - ae308202-f6c6-48ab-9a61-2e089fa4e284
 - _Node_0**
 - ReliableActorsType
 - Nodes
 - System

Instance 131749445908447269

ESSENTIALS DETAILS

Id
131749445908447269

Health State
OK

ADDRESS

Endpoints
(empty) <http://PL-C-WAW-KAMZ-1.emea.demant.com:80>

UNHEALTHY EVALUATIONS

http://PL-C-WAW-KAMZ-1.emea.demant.com:80

GET http://PL-C-WAW-KAMZ-1.emea.demant.com:80

Authorization Headers Body Pre-request Script Tests

Type No Auth

Body Cookies Headers (3) Test Results

Pretty Raw Preview Text

1 Hello From Service Fabric!

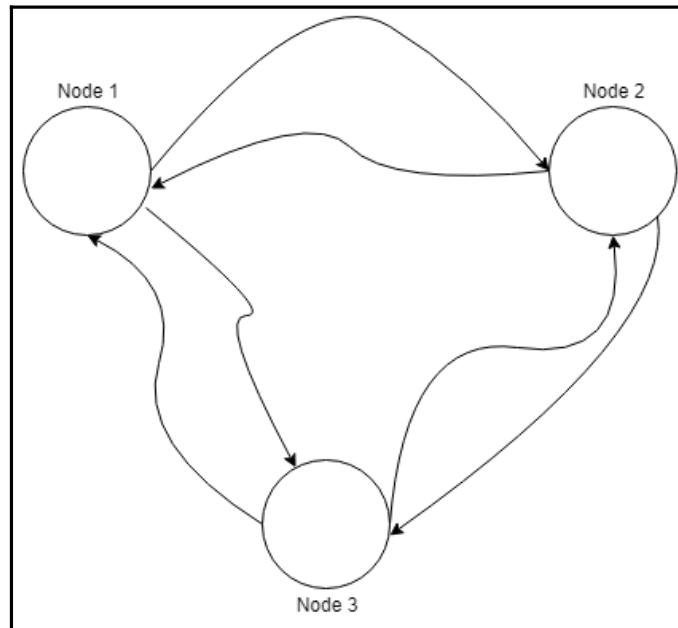
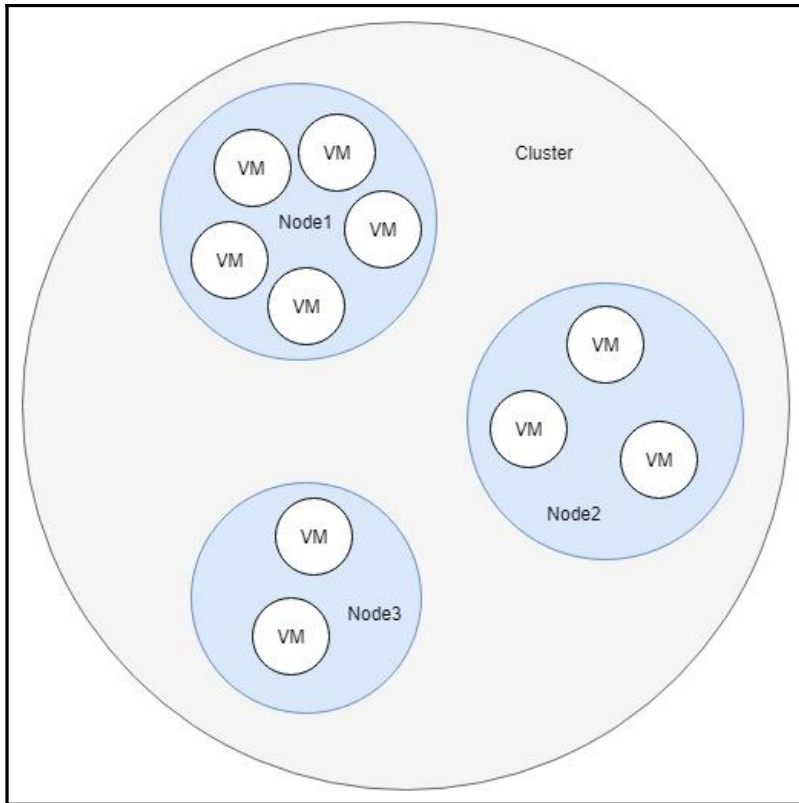

Cluster configuration ☐ ✕
Configure node types and diagnostics

Node types define the scale sets that will be used to manage your cluster. You specify between 1 and 3 in the portal. [Learn more about node types](#)

* Node type count ⓘ
 1 2 3

* Node type 1 (Primary) >
Configure required settings

* Node type 2 >
Configure required settings

[Hide optional settings](#)

Diagnostics

Create application log storage ⓘ
 On Off

Application Insights key (optional) ⓘ

Add on features

Include DNS service ⓘ

localhost:19080/Explorer/index.html#

Microsoft Azure Service Fabric Explorer

OK Warning Error

Search Cluster

Cluster http://localhost

ESSENTIALS DETAILS CLUSTER MAP METRICS MANIFEST

Cluster Health State
OK

System Application Health State
OK

Upgrade Domains
1

Healthy Seed Nodes
1 (100%)

Fault Domains
1

Cluster

- Applications
 - HandsOnAzuresReliableServiceType
 - ReliableActorsType
 - fabric/ReliableActors
 - fabric/ReliableActors/ReliableActorService
- Nodes
- System

DASHBOARD

| | | | |
|---|---|---|---|
| <p>1 NODE</p> <p>ERROR: 0 WARNING: 0 HEALTHY: 1</p> | <p>2 APPLICATIONS</p> <p>ERROR: 0 WARNING: 0 HEALTHY: 2</p> | <p>3 SERVICES</p> <p>ERROR: 0 WARNING: 0 HEALTHY: 3</p> | <p>3 REPLICAS</p> <p>ERROR: 0 WARNING: 0 HEALTHY: 3</p> |
| <p>3 PARTITIONS</p> <p>ERROR: 0 WARNING: 0 HEALTHY: 3</p> | | | <p>UPGRADE IN PROGRESS</p> <p>0</p> |

Chapter 05: Using Azure Search

The screenshot shows the 'New Search Service' configuration page in the Azure portal. The breadcrumb navigation at the top reads 'Home > New > Azure Search > New Search Service'. The page title is 'New Search Service'. The configuration fields are as follows:

- URL:** A text input field containing 'handsonazuresearch' with a green checkmark. Below it, the domain '.search.windows.net' is displayed.
- Subscription:** A dropdown menu showing 'Visual Studio Enterprise'.
- Resource group:** Radio buttons for 'Create new' (selected) and 'Use existing'. Below, a text input field contains 'handsonazure-rg' with a green checkmark.
- Location:** A dropdown menu showing 'West Europe'.
- Pricing tier:** A dropdown menu showing 'Standard' with a right-pointing arrow.

The screenshot shows the 'handsonazuresearch' Search service overview page in the Azure portal. The breadcrumb navigation at the top reads 'Home > Resource groups > handsonazure-rg > handsonazuresearch'. The page title is 'handsonazuresearch Search service'. The page layout includes:

- Search bar:** A search input field with the placeholder text 'Search (Ctrl+ /)'.
- Navigation menu:** A list of navigation items: 'Overview' (selected), and 'Access control (IAM)'. Above these are icons for '+ Add index', 'Import data', 'Search explorer', 'Delete', and 'Move'.
- Essentials section:** A section titled 'Essentials' with an upward arrow. It contains an 'Import data' button.
- Uri:** The text 'Uri https://handsonazuresearch.search.windows.net'.
- Pricing tier:** The text 'Pricing tier'.

Home > Resource groups > handsonazure-rg > handsonazuresearch > Import data > Data Source > Samples

Import data

- Data Source
Connect to your data >
- Cognitive Search
Add cognitive skills (Optional) 🔒
- Index
Customize target index 🔒
- Indexer
Import your data 🔒

Data Source

Existing data source 🔒

- Samples >
- Azure SQL Database >
- SQL Server on Azure VMs >

Samples

| TYPE | NAME |
|------|----------------------|
| | realestate-us-sample |

Search explorer

handsonazuresearch

Change index | Set API version

Query string ⓘ
 Examples: *, \$top=10, \$top=10&\$skip=10&search=* Index: realestate-us-sample
API version: 2016-09-01

Request URL
[https://handsonazuresearch.search.windows.net/indexes/realestate-us-sample/docs?api-version=2016-09-01&search=*](https://handsonazuresearch.search.windows.net/indexes/realestate-us-sample/docs?api-version=2016-09-01&search=)

Results

```

1 {
2   "@odata.context": "https://handsonazuresearch.search.windows.net/indexes
3   ('realestate-us-sample')/$metadata#docs",
4   "value": [
5     {
6       "@search.score": 1,
7       "listingId": "9382555",
8       "beds": 3,
9       "baths": 3,
10      "description": "This is a apartment residence and is freshly painted. Enjoy
11      gleaming hardwood floors located on a no outlet and features stainless steel appliances, a
      wall of windows and a guest house.",
12      "description_de": "Dies ist eine Wohnanlage und ist frisch gestrichen. Genießen
      Sie glänzenden Holzböden Das Hotel liegt auf einem keine Steckdose und
      Funktionen-Edelstahl-Geräte, eine Wand von windows and ein Gästehaus.",
13      "description_fr": "Il s'agit d'un appartement de la résidence et est fraîchement
      peint. Profitez de parquet brillant Situé sur une aucune prise et les appareils d'acier
      inoxydable caractéristiques, un mur de fenêtres and une maison d'hôtes.",
14    }
15  ]
16 }
  
```

Home > Resource groups > handsonazure-rg > handsonazuresearch - Keys

handsonazuresearch - Keys

Search service

Search (Ctrl+/) <<

Regenerate primary Regenerate secondary

PRIMARY ADMIN KEY

38B4F66ACD480406328C62273C056CA4

SECONDARY ADMIN KEY

E27007F49D6C509C9790AE5CF037C2DB

Manage query keys

Overview

Access control (IAM)

Tags

SETTINGS

Quick start

Keys

Scale

Home > Resource groups > handsonazure-rg > handsonazuresearch > realestate-us-sample > Fields

realestate-us-sample

Indexes

+ Add/Edit Fields + Add scoring profile Edit CORS options Delete

Usage

| Document count | |
|----------------|-------|
| Index | 4,959 |
| Service | 4,959 |

Storage size

23%
23

Search explorer

Fields

| FIELD NAME | TYPE | ATTRIBUTES |
|-------------|------------|---------------------------------|
| listingId | Edm.String | Key, Retrievable |
| beds | Edm.Int32 | Filterable, Facetable, Sorta... |
| baths | Edm.Int32 | Filterable, Facetable, Sorta... |
| description | Edm.String | Searchable, Retrievable |

Home > Resource groups > handsonazure-rg > handsonazuresearch > realestate-us-sample > Fields

realestate-us-sample

Indexes

+ Add/Edit Fields + Add scoring profile Edit CORS options Delete

Usage

| Document count | |
|----------------|-------|
| Index | 4,959 |
| Service | 4,959 |

Storage size

23%
23

Search explorer

Fields

| FIELD NAME | TYPE | ATTRIBUTES |
|----------------|------------|---------------------------------|
| listingId | Edm.String | Key, Retrievable |
| beds | Edm.Int32 | Filterable, Facetable, Sorta... |
| baths | Edm.Int32 | Filterable, Facetable, Sorta... |
| description | Edm.String | Searchable, Retrievable |
| description_de | Edm.String | Searchable, Retrievable |

Save Discard

| | | | | | | | |
|----------------|------------|-------------------------------------|-------------------------------------|-------------------------------------|-------------------------------------|-------------------------------------|---------------------|
| description_de | Edm.String | <input checked="" type="checkbox"/> | <input type="checkbox"/> | <input type="checkbox"/> | <input type="checkbox"/> | <input checked="" type="checkbox"/> | German - Microsoft |
| description_fr | Edm.String | <input checked="" type="checkbox"/> | <input type="checkbox"/> | <input type="checkbox"/> | <input type="checkbox"/> | <input checked="" type="checkbox"/> | French - Microsoft |
| description_it | Edm.String | <input checked="" type="checkbox"/> | <input type="checkbox"/> | <input type="checkbox"/> | <input type="checkbox"/> | <input checked="" type="checkbox"/> | Italian - Microsoft |
| description_es | Edm.String | <input checked="" type="checkbox"/> | <input type="checkbox"/> | <input type="checkbox"/> | <input type="checkbox"/> | <input checked="" type="checkbox"/> | Spanish - Microsoft |
| description_pl | Edm.String | <input checked="" type="checkbox"/> | <input type="checkbox"/> | <input type="checkbox"/> | <input type="checkbox"/> | <input checked="" type="checkbox"/> | Polish - Microsoft |
| description_nl | Edm.String | <input checked="" type="checkbox"/> | <input type="checkbox"/> | <input type="checkbox"/> | <input type="checkbox"/> | <input checked="" type="checkbox"/> | Dutch - Microsoft |
| sqft | Edm.Int32 | <input checked="" type="checkbox"/> | <input checked="" type="checkbox"/> | <input checked="" type="checkbox"/> | <input checked="" type="checkbox"/> | | |
| daysOnMarket | Edm.Int32 | <input checked="" type="checkbox"/> | <input checked="" type="checkbox"/> | <input checked="" type="checkbox"/> | <input checked="" type="checkbox"/> | | |
| status | Edm.String | <input checked="" type="checkbox"/> | <input checked="" type="checkbox"/> | <input type="checkbox"/> | <input checked="" type="checkbox"/> | <input type="checkbox"/> | |
| source | Edm.String | <input checked="" type="checkbox"/> | <input type="checkbox"/> | <input type="checkbox"/> | <input type="checkbox"/> | <input checked="" type="checkbox"/> | English - Microsoft |
| number | Edm.String | <input checked="" type="checkbox"/> | <input type="checkbox"/> | <input type="checkbox"/> | <input type="checkbox"/> | <input checked="" type="checkbox"/> | English - Microsoft |
| street | Edm.String | <input checked="" type="checkbox"/> | <input type="checkbox"/> | <input type="checkbox"/> | <input type="checkbox"/> | <input checked="" type="checkbox"/> | English - Microsoft |
| unit | Edm.String | <input checked="" type="checkbox"/> | <input type="checkbox"/> | <input type="checkbox"/> | <input type="checkbox"/> | <input checked="" type="checkbox"/> | English - Microsoft |
| type | Edm.String | <input checked="" type="checkbox"/> | <input checked="" type="checkbox"/> | <input type="checkbox"/> | <input checked="" type="checkbox"/> | <input type="checkbox"/> | |
| city | Edm.String | <input checked="" type="checkbox"/> | <input checked="" type="checkbox"/> | <input type="checkbox"/> | <input checked="" type="checkbox"/> | <input checked="" type="checkbox"/> | English - Microsoft |

| | | | | | | | | |
|------------|--------------|--------------------------|--------------------------|--------------------------|--------------------------|-------------------------------------|---------------------|-----|
| my_field ✓ | Edm.String ▾ | <input type="checkbox"/> | <input type="checkbox"/> | <input type="checkbox"/> | <input type="checkbox"/> | <input checked="" type="checkbox"/> | Standard - Lucene ▾ | ... |
| | Edm.String ▾ | <input type="checkbox"/> | <input type="checkbox"/> | <input type="checkbox"/> | <input type="checkbox"/> | <input type="checkbox"/> | | |

Home > Resource groups > handsonazure-rg > handsonazuresearch > Import data > Create an Indexer > Advanced options

Import data

- Data Source: **tablestorage**
- Cognitive Search: Add cognitive skills (Optional)
- Index: **azuretable-index**
- Indexer: **Import your data**

Create an Indexer

Name: ✓

Schedule: Once **Hourly** Daily Custom

Automatic change tracking for Azure Table data sources.

Track deletions:

Soft delete column: ▾

Delete marker value: ✓

Advanced options:

Advanced options

Base-64 Encode Keys:

Max failed items:

Max failed items per batch:

Batch size: ✓

Home > Resource groups > handsonazure-rg > handsonazuresearch > Indexers > sampleindexer

Indexers

| NAME | STATUS | LAST RUN | DOCS SUCCEEDED |
|-----------------|---------|----------|----------------|
| sampleindexer ✓ | Success | 5 d ago | 4959/4959 |

sampleindexer

Indexer

Run Reset Edit Delete

Indexer summary

Execution history

Execution details

| LAST RUN | STATUS | DOCS SUCCEEDED |
|-------------------|---------|----------------|
| 4.07, 10:51 UTC ✓ | Success | 4959/4959 |

Home > Resource groups > handsonazure-rg > handsonazuresearch > Import data > Cognitive Search

Import data

- Data Source
realestate-us-sample >
- Cognitive Search
Add cognitive skills (Optional) >
- Index
Customize target index >
- Indexer
Import your data

Cognitive Search

Enrich and extract structure from your documents through cognitive skills using the same AI algorithms that power Cognitive Services. Select the document cracking options and the cognitive skills you want to apply to your documents. [Learn more](#)

* Skillset name

Skillset and index fields

Run cognitive skills over a source data field to create additional searchable fields. [Learn about additional skills and extensibility here.](#)

Source data field

| <input type="checkbox"/> | COGNITIVE SKILLS | FIELD NAME |
|--------------------------|----------------------|------------|
| <input type="checkbox"/> | Extract people names | people |

| | | | | | | | |
|----------------------|------------------|-------------------------------------|-------------------------------------|-------------------------------------|-------------------------------------|-------------------------------------|-----|
| location | Edm.Geograp... | <input checked="" type="checkbox"/> | <input checked="" type="checkbox"/> | <input checked="" type="checkbox"/> | | | ... |
| price | Edm.Int64 | <input checked="" type="checkbox"/> | <input checked="" type="checkbox"/> | <input checked="" type="checkbox"/> | <input checked="" type="checkbox"/> | | ... |
| thumbnail | Edm.String | <input checked="" type="checkbox"/> | <input type="checkbox"/> | <input type="checkbox"/> | <input type="checkbox"/> | <input type="checkbox"/> | ... |
| tags | Collection(Ed... | <input checked="" type="checkbox"/> | <input checked="" type="checkbox"/> | | | <input checked="" type="checkbox"/> | ... |
| <input type="text"/> | Edm.String | <input type="checkbox"/> | <input type="checkbox"/> | <input type="checkbox"/> | <input type="checkbox"/> | <input type="checkbox"/> | |

| | | | | | | | |
|----------------------|------------------|-------------------------------------|-------------------------------------|-------------------------------------|-------------------------------------|-------------------------------------|-----|
| location | Edm.Geograp... | <input checked="" type="checkbox"/> | <input checked="" type="checkbox"/> | <input checked="" type="checkbox"/> | | | ... |
| price | Edm.Int64 | <input checked="" type="checkbox"/> | <input checked="" type="checkbox"/> | <input checked="" type="checkbox"/> | <input checked="" type="checkbox"/> | | ... |
| thumbnail | Edm.String | <input checked="" type="checkbox"/> | <input type="checkbox"/> | <input type="checkbox"/> | <input type="checkbox"/> | <input type="checkbox"/> | ... |
| tags | Collection(Ed... | <input checked="" type="checkbox"/> | <input checked="" type="checkbox"/> | | | <input checked="" type="checkbox"/> | ... |
| language | Edm.String | <input checked="" type="checkbox"/> | <input type="checkbox"/> | <input type="checkbox"/> | <input type="checkbox"/> | <input checked="" type="checkbox"/> | ... |
| <input type="text"/> | Edm.String | <input type="checkbox"/> | <input type="checkbox"/> | <input type="checkbox"/> | <input type="checkbox"/> | <input type="checkbox"/> | |

Chapter 06: Mobile Notifications with Notification Hub

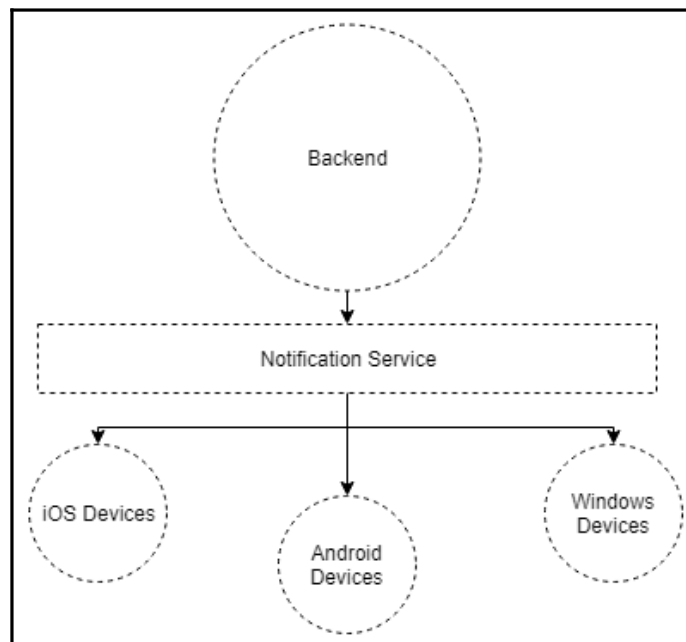
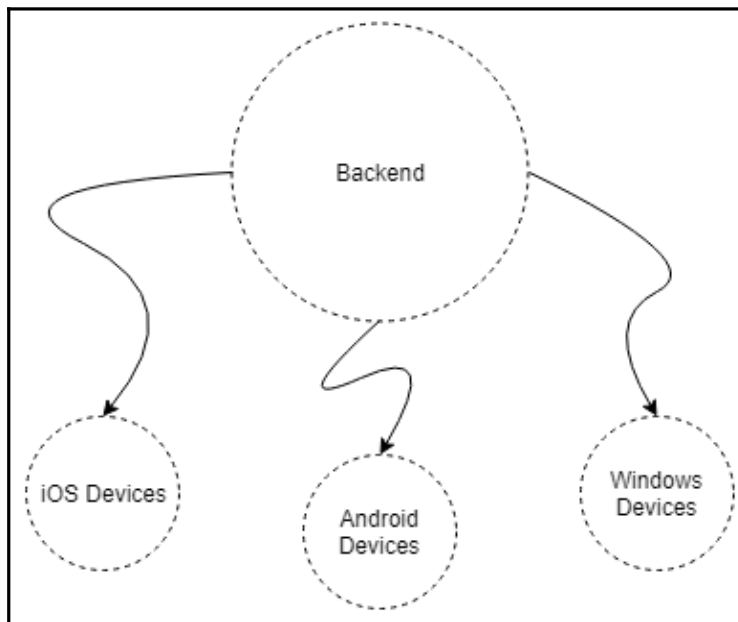

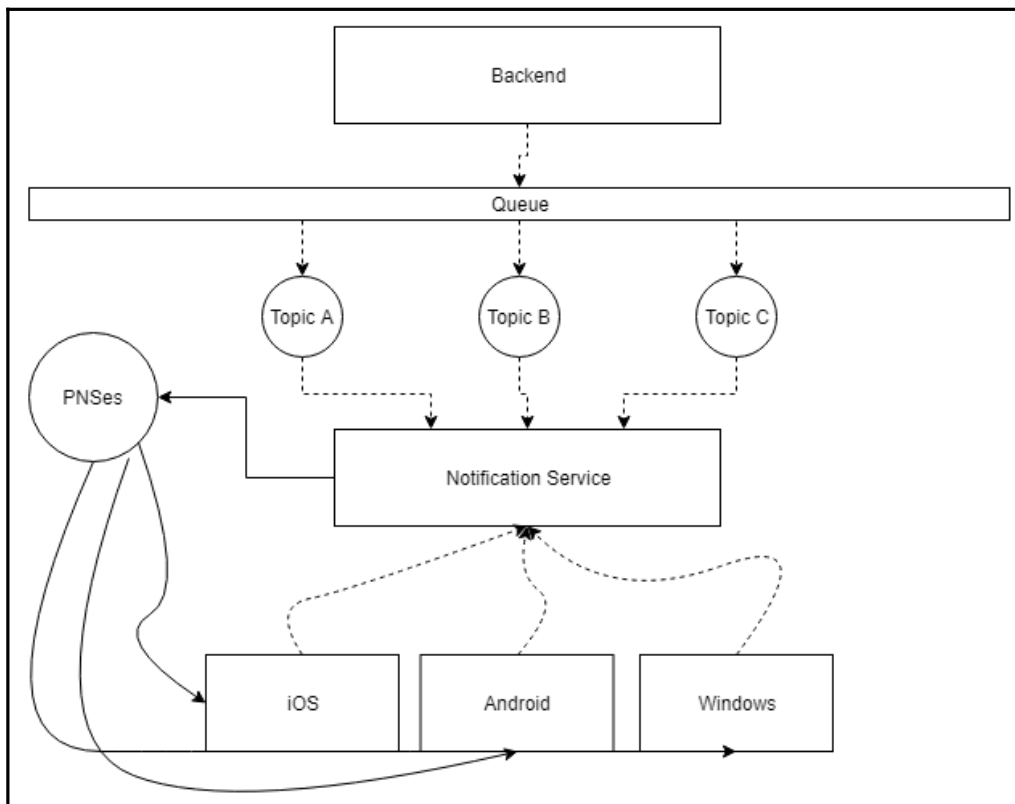
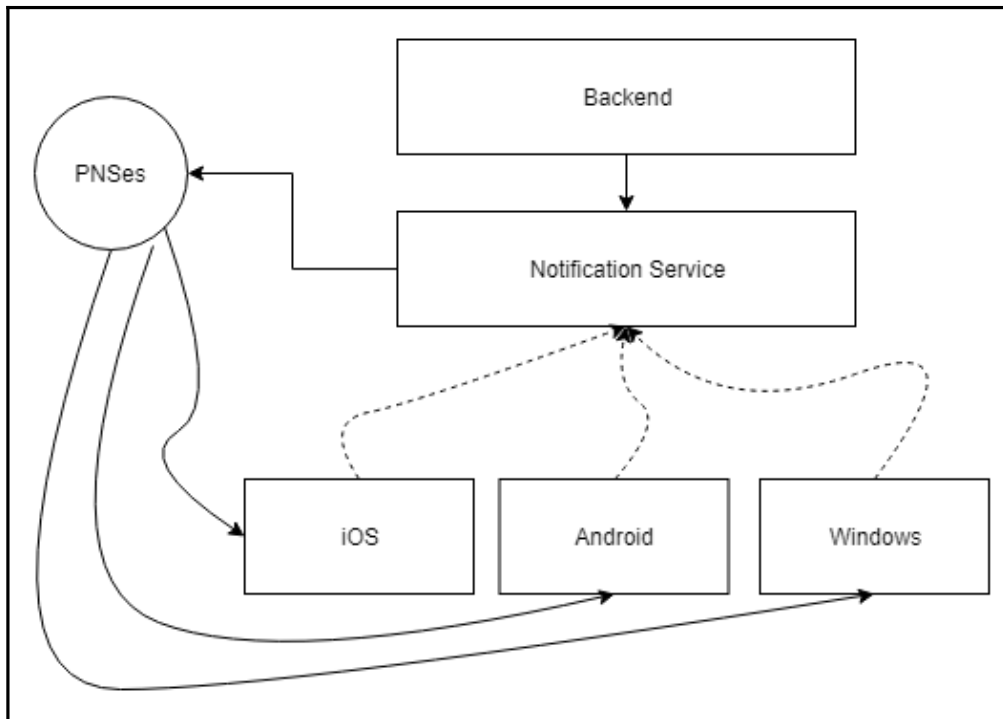

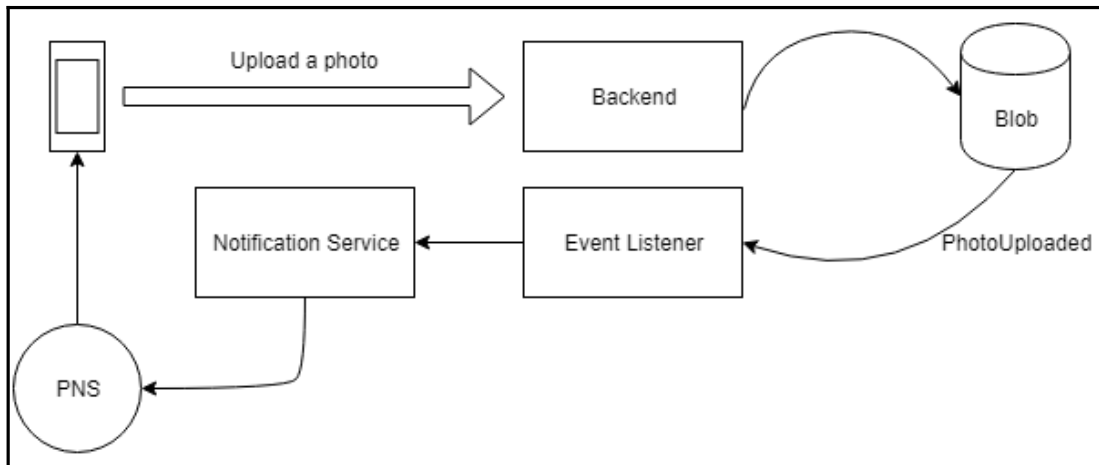

Home > New > Notification Hub >

* Notification Hub
 ✓

* Create a new namespace
 ✓
[Select existing](#)

* Location
 ▾

* Resource Group
 Create new Use existing
 ▾

* Subscription
 ▾

Pricing tier
 Free >

Home > Resource groups > handsonazure-rg > handsonazurehubnamespace

handsonazurehubnamespace

Notification Hub Namespace

Search (Ctrl+/) << + Add Hub Delete

- Overview
- Activity log
- Access control (IAM)
- Tags
- Properties

MANAGE

- Access Policies
- Pricing Tier

Essentials ^

| | | | |
|----------------------------|--------------------------------------|-------------------|--|
| Resource group (change) | handsonazure-rg | Name | handsonazurehubnamespace |
| Subscription ID | 94f33c43-60b5-4042-ae74-51777f69f99a | Status | Active |
| Subscription name (change) | Visual Studio Enterprise | Pricing Tier | Free |
| Location | West Europe | Service Endpoint | https://handsonazurehubnamespace.servicebus.windows.net:443/ |
| | | Last Updated Date | 2018-07-14T18:47:15.867Z |

| NOTIFICATION HUB | STATUS | ACTIVE DEVICE | REGION | SUBSCRIPTION |
|------------------|---------|---------------|-------------|--------------------------|
| handsonazurehub | Running | 0 | West Europe | Visual Studio Enterprise |

Registration successful: 4247747649211062654-6072041241190477240-2

OK

Server Explorer

- Azure (kamz@demant-technology.co)
 - App Service
 - Cloud Services
 - Data Lake Analytics
 - HDInsight
 - Notification Hubs
 - handsonazurehub

handsonazurehub Notification Hub - App.xaml.cs NuGet: HandsOnAzureApp HandsOnAzureApp

Diagnose issues with your notification hub by sending test messages and browsing device registrations.

Test Send Device Registrations

Filter by single tag:

Registrations (1 loaded):

| Platform | Type | Tags | PNS Identifier | Registration ID | Expiration Date |
|---------------|--------|------|--|--|---------------------|
| Windows (WNS) | Native | | https://bl2p.notify.windows.com/?token=... | 4247747649211062654-60720412411904772... | 31.12.9999 23:59:59 |

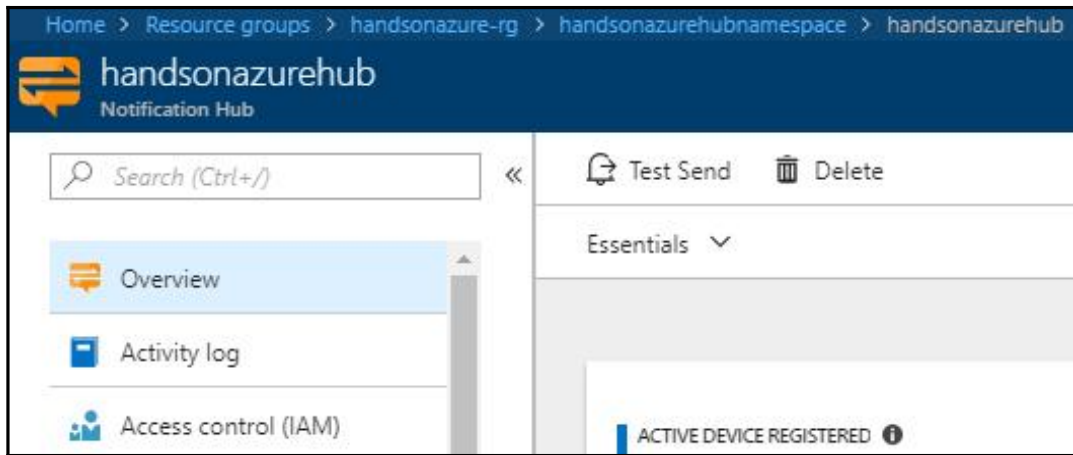

Home > Resource groups > handsonazure-rg > handsonazurehubnamespace > handsonazurehub > Test

Test Send

Send a test notification to 10 random registered devices

Settings

Platforms
Windows

Send to Tag Expression ⓘ

Notification Type
Toast

Payload

```
1 <?xml version="1.0" encoding="utf-8"?>
2 <toast>
3 <visual><binding template="ToastText01">
4 <text id="1">Test message</text>
5 </binding>
6 </visual>
7 </toast>
8
```

Send

Result

| PLATFORM | REGISTRATION | OUTCOME |
|----------|--------------|---------|
|----------|--------------|---------|

Chapter 07: Serverless and Azure Functions

| Model | IaaS | PaaS | Serverless |
|-------------------|------|------|------------|
| Data center | √ | √ | √ |
| Network security | √ | √ | √ |
| Operating systems | × | √ | √ |
| Dev tools | × | √ | √ |
| Application Host | × | × | √ |

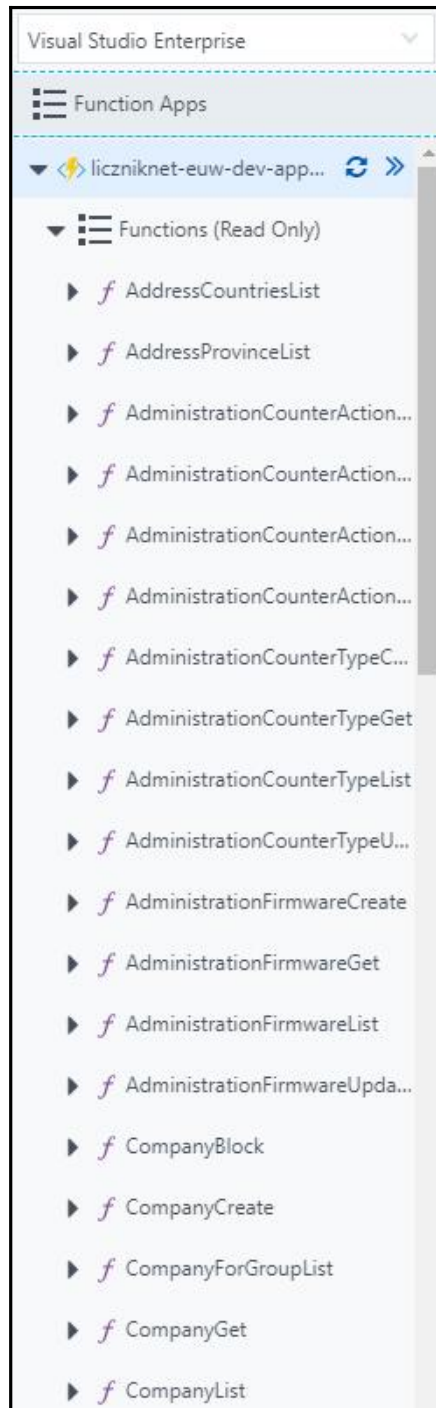

```
[FunctionName("UserState")]
0 references | Kamil Mrzyglód, 2 days ago | 1 author, 1 change
public static Task<HttpResponseMessage> UserState(
    [HttpTrigger(AuthorizationLevel.Anonymous, "get", Route = "state/user")] HttpRequestMessage req,
    [Table(Table Name, PartitionKey, Connection = Constants.TableStorageConnectionName)] IQueryable<User> users,
    [Table(UserXCompanyEntity.Table Name, Connection = Constants.TableStorageConnectionName)] IQueryable<UserXCompanyEntity> usersXCompanies,
    [Table(Company.Company.Table Name, Connection = Constants.TableStorageConnectionName)] IQueryable<Company> companies,
    [Identity] UserIdentity identity,
    TraceWriter log)
{
    if (identity.IsAuthenticated() == false) return Task.FromResult(identity.Response);

    var user = users.Take(1).ToList().First();
    var userCompanies = usersXCompanies.Where(_ => _.PartitionKey == user.RowKey).ToList();
    var userMainCompanyId = userCompanies.First(_ => _.IsMain).RowKey;
}
```

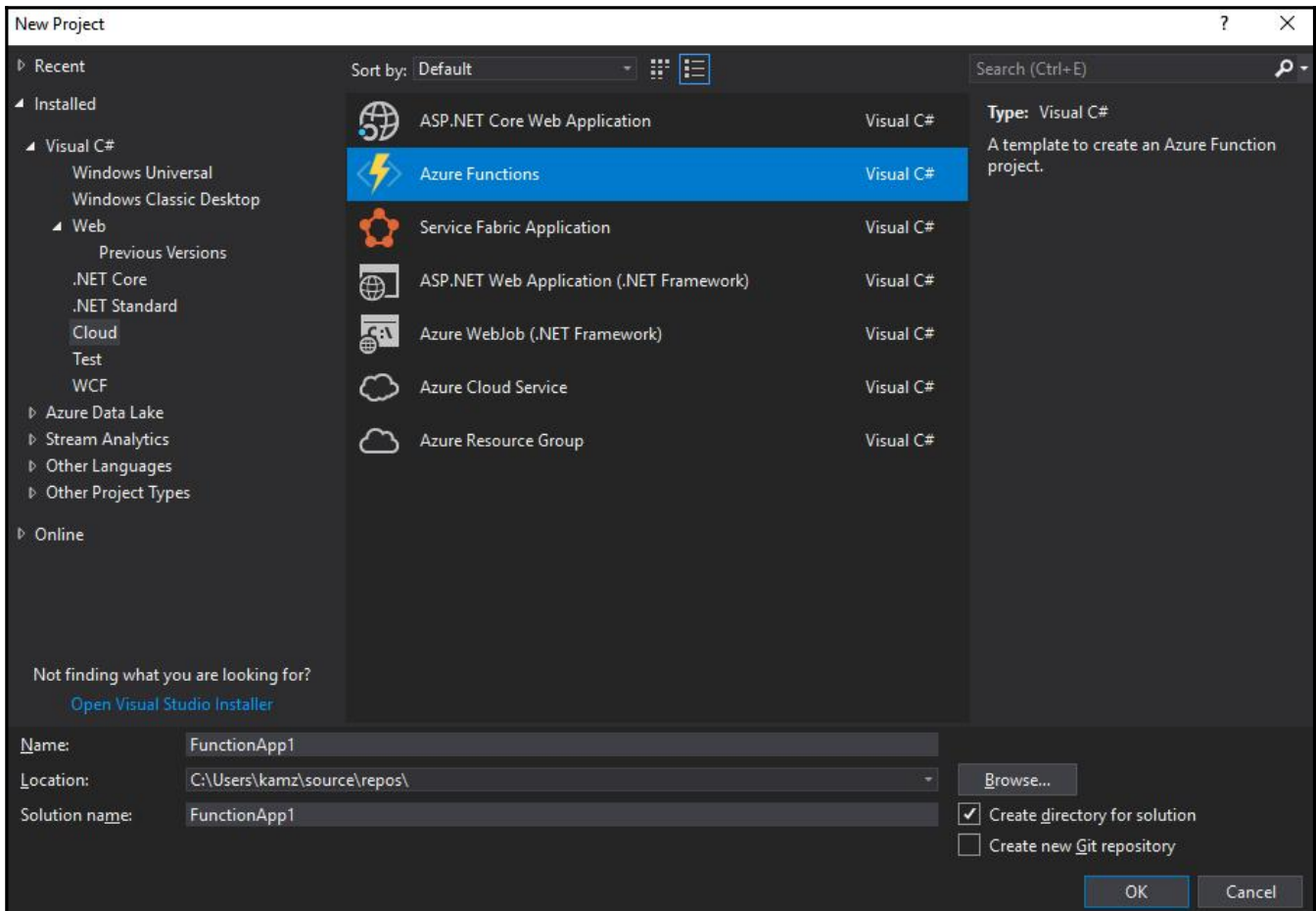

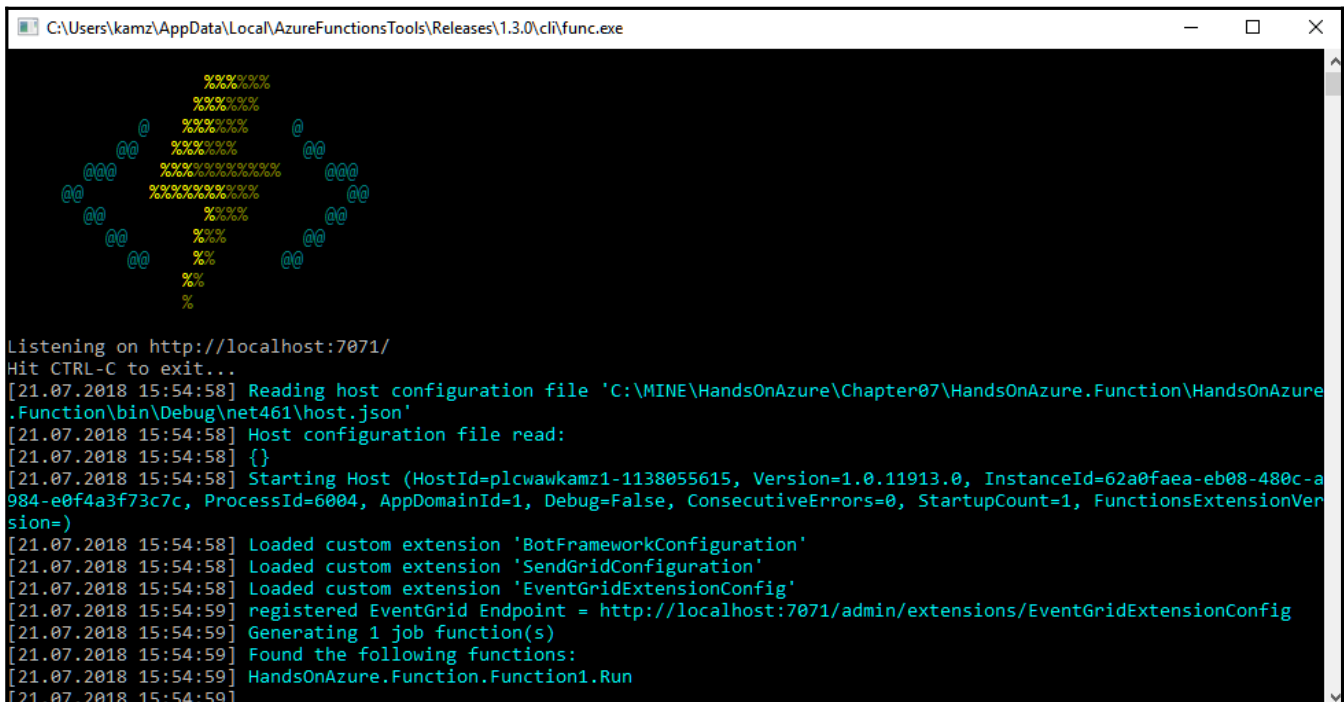
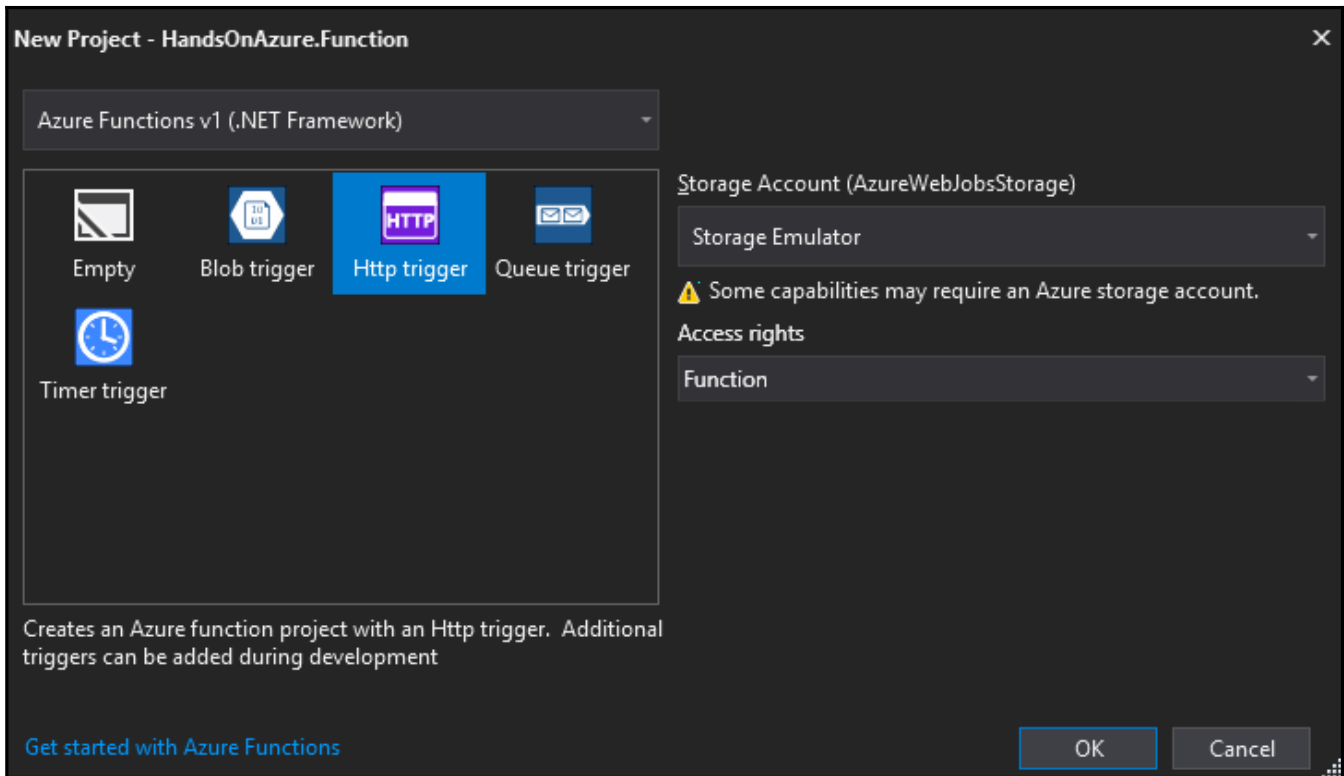

Http Functions:

Function1: <http://localhost:7071/api/Function1>

```
[21.07.2018 15:55:00] Host started (2389ms)
[21.07.2018 15:55:00] Job host started
[21.07.2018 15:55:01] Host lock lease acquired by instance ID '000000000000000000000000000016B02F0D'.
Debugger listening on [::]:5858
```

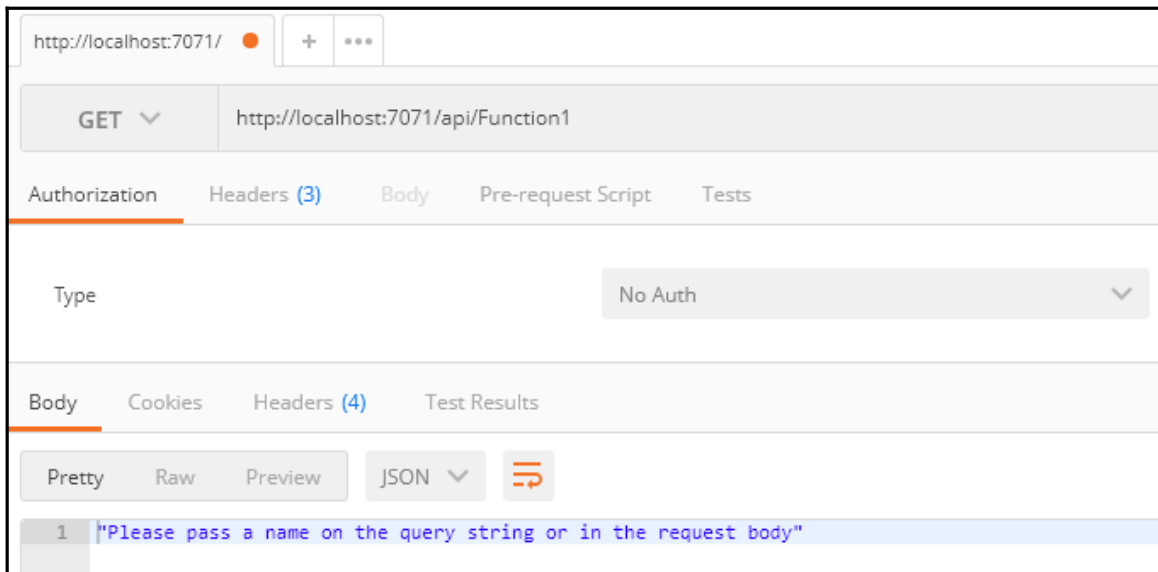

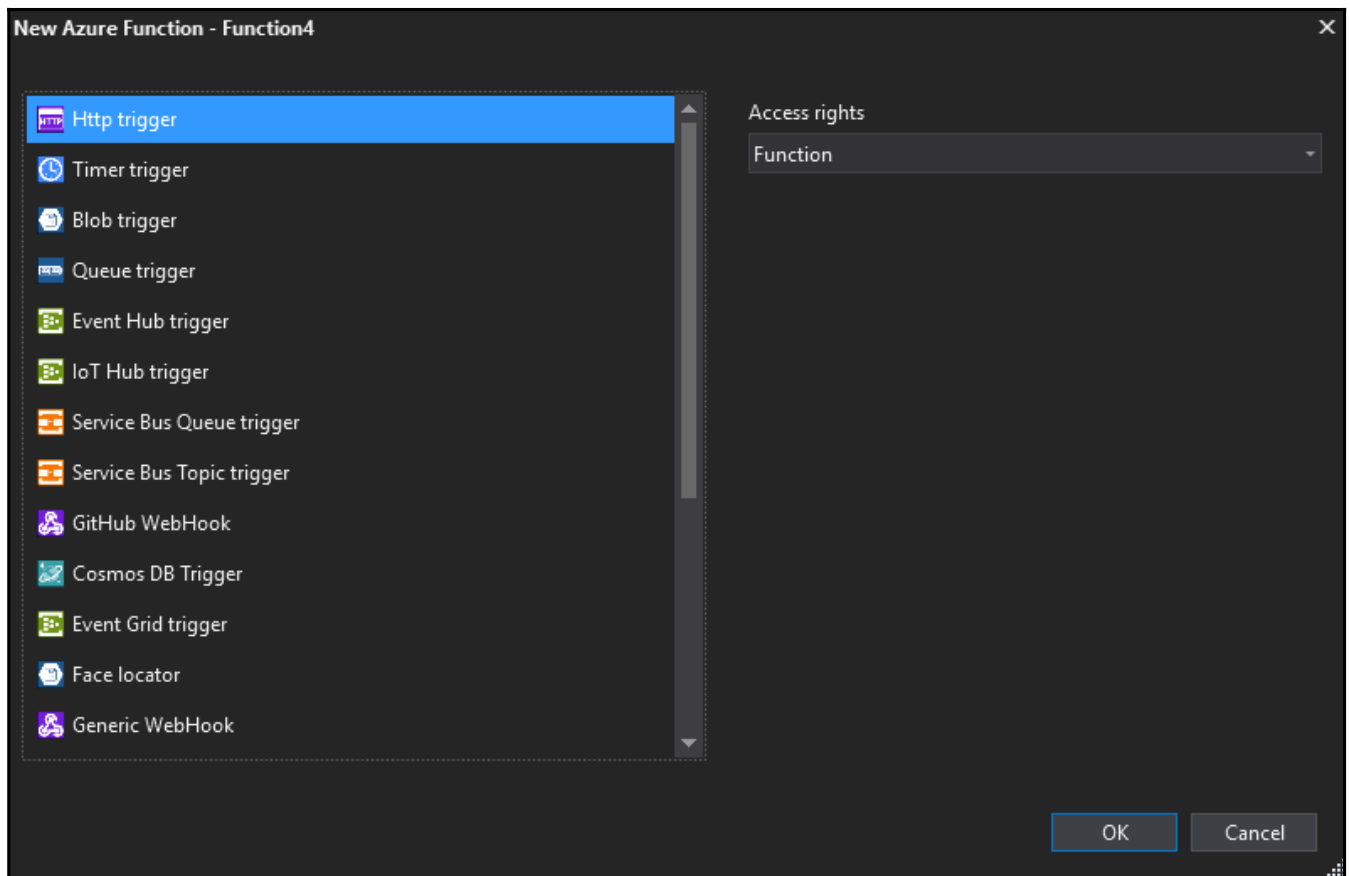

Home > New > Function App > Function App

Function App

Create

* App name
handsonazurefunctionapp ✓
.azurewebsites.net

* Subscription
Visual Studio Enterprise

* Resource Group ⓘ
 Create new Use existing
handsonazure-rg

* OS **Windows** Linux (Preview) Docker

* Hosting Plan ⓘ
Consumption Plan

* Location
Central US

* Storage ⓘ
 Create new Use existing
handsonazurefunction ✓

Application Insights ⓘ **On** Off

* Application Insights Location ⓘ
West Europe

Home > Resource groups > handsonazure-rg > handsonazurefunctionapp

handsonazurefunctionapp

Function Apps

Visual Studio Enterprise

Function Apps

handsonazurefunctionapp

Functions

Proxies

Slots (preview)

Overview Platform features

Stop Swap Restart Download publish profile Reset publish credentials Download app content Delete

Status: Running

Subscription: Visual Studio Enterprise

Resource group: handsonazure-rg

URL: https://handsonazurefunctionapp.azurewebsites.net

Subscription ID: [REDACTED]-51777f69f99a

Location: Central US

App Service plan / pricing tier: CentralUSPlan (Consumption)

Configured features

- Function app settings
- Application settings



Get started quickly with a premade function

1. Choose a scenario

Webhook + API Timer Data processing

2. Choose a language

CSharp JavaScript FSharp Java

For PowerShell, Python, and Batch, create your own custom function.

Create this function

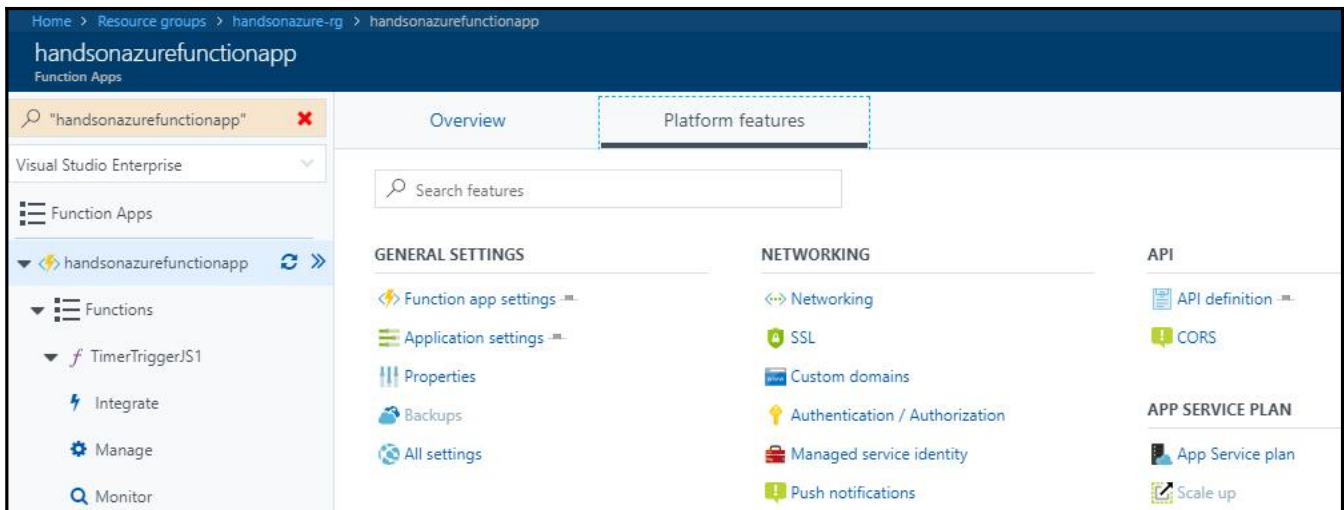

Home > Resource groups > handsonazure-rg > handsonazurefunctionapp

handsonazurefunctionapp

Function Apps

Visual Studio Enterprise

Function Apps

handsonazurefunctionapp

- Functions
- TimerTriggerJS1
 - Integrate
 - Manage
 - Monitor
- Proxies
- Slots (preview)

Overview Platform features Function app settings

Daily Usage Quota (GB-Sec)

Enter value in GB-sec

Application settings

[Manage application settings](#)

Runtime version

Runtime version: 1.0.11913.0 (~1)

Cannot Upgrade with Existing Functions
Major version upgrades can introduce breaking changes to languages and bindings. When upgrading migrate your functions to this new app.

Function app edit mode

Change the edit mode of your function app

Slots (preview)

Enable deployment slots (preview).

Known issues:
Logic apps integration with Functions does not work when Slots(preview) is enabled. Opting into this preview feature will reset any pre-existing secrets. Function secrets can be found

Home > Resource groups > handsonazure-rg > handsonazurefunctionapp - TimerTriggerJS1

handsonazurefunctionapp - TimerTriggerJS1

Function Apps

Search: "handsonazurefunctionapp" ✕

Visual Studio Enterprise ▾

- Function Apps
 - handsonazurefunctionapp
 - Functions
 - TimerTriggerJS1
 - Integrate
 - Manage**
 - Monitor
 - Proxies
 - Slots (preview)



Function State

Enabled Disabled 🗑️ Delete function

Host Keys (All functions)

| NAME | VALUE |
|---------|-------------------------------|
| _master | Click to show |
| default | Click to show |

[Add new host key](#)

- ▼  Functions (Read Only)
- ▼ *f* AddressCountriesList
-  Integrate
- ⚙️ Manage
-  Monitor
- ▶ *f* AddressProvinceList
- ▶ *f* AdministrationCounterAction...
- ▶ *f* AdministrationCounterAction...
- ▶ *f* AdministrationCounterAction...
- ▶ *f* AdministrationCounterAction...
- ▶ *f* AdministrationCounterTypeC...
- ▶ *f* AdministrationCounterTypeGet
- ▶ *f* AdministrationCounterTypeList

Function Keys

| NAME | VALUE |
|---------|-------------------------------|
| default | Click to show |

Add new function key

Host Keys (All functions)

| NAME | VALUE |
|---------|-------------------------------|
| _master | Click to show |
| default | Click to show |

Add new host key

Home > Resource groups > handsonazure-rg > handsonazurefunctionapp - TimerTriggerJS1

handsonazurefunctionapp - TimerTriggerJS1

Function Apps

Search: "handsonazurefunctionapp" ✖ Refresh

Visual Studio Enterprise

- Function Apps
- handsonazurefunctionapp
 - Functions
 - HttpTriggerJS1
 - Integrate
 - Manage
 - Monitor
 - TimerTriggerJS1
 - Integrate
 - Manage
 - Monitor
 - TimerTriggerJS2

For a richer monitoring experience, including live metrics and custom queries: [configure Application](#)

Success count since Jul 1st

289

Invocation log

| Function | Status |
|--|--------|
| TimerTriggerJS1 (2018-07-23T09:15:0 ...) | ✓ |
| TimerTriggerJS1 (2018-07-23T09:10:0 ...) | ✓ |
| TimerTriggerJS1 (2018-07-23T09:05:0 ...) | ✓ |
| TimerTriggerJS1 (2018-07-23T09:00:0 ...) | ✓ |
| TimerTriggerJS1 (2018-07-23T08:55:0 ...) | ✓ |
| TimerTriggerJS1 (2018-07-23T08:50:0 ...) | ✓ |

Pick a publish target

- Azure Function App
- Folder

Azure App Service

Fully managed, and highly scalable cloud environment

- Create New
- Select Existing





Subscription
 Visual Studio Enterprise

View
 Resource Group

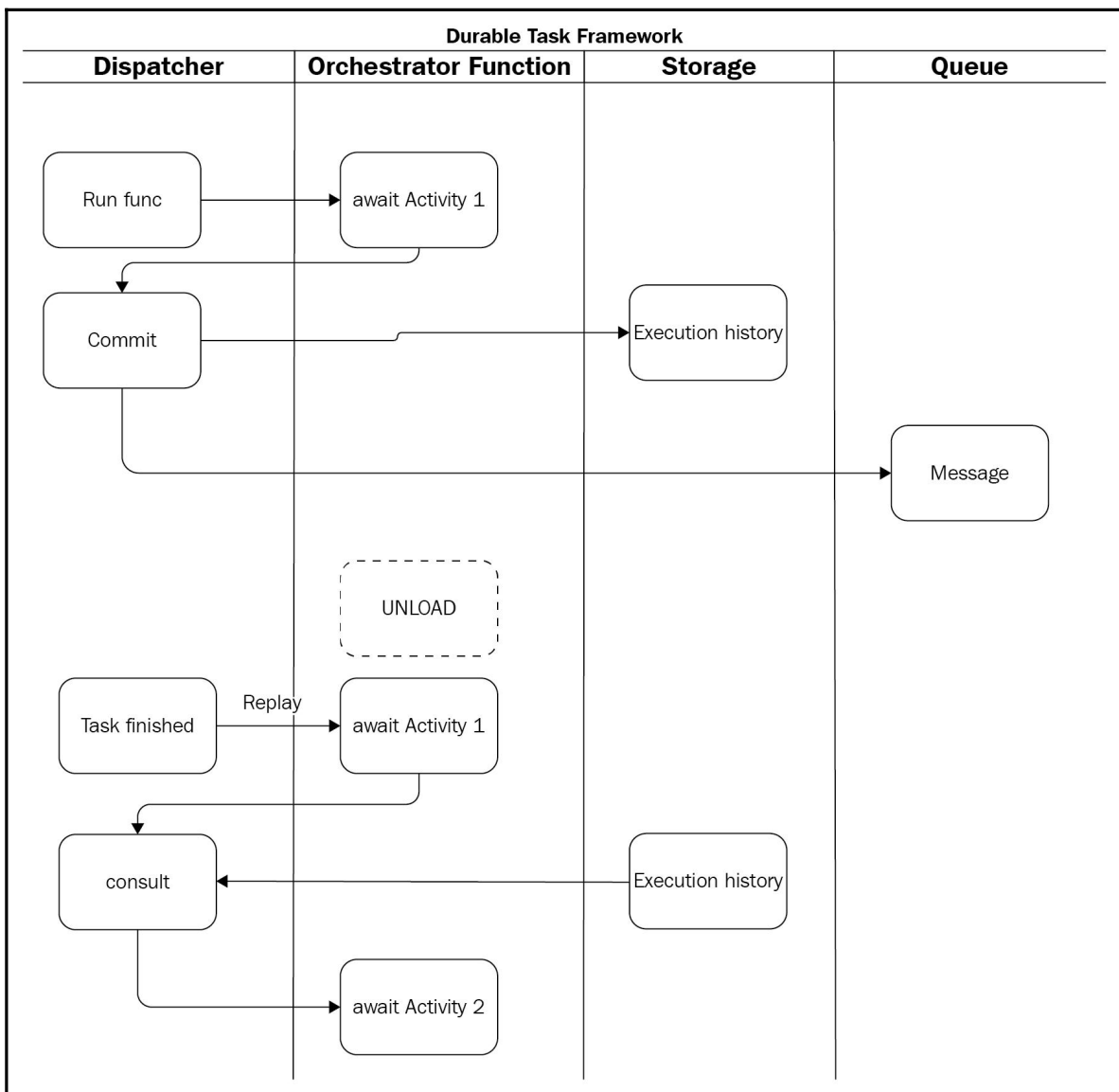
Search

handsonazure-rg
 handsonazurefunctionapp



| | | |
|--|------------------|-------------|
|  bin | 21.07.2018 17:54 | File folder |
|  Function1 | 21.07.2018 17:54 | File folder |
|  host | 21.07.2018 17:53 | JSON File |
|  local.settings | 21.07.2018 17:53 | JSON File |

```
[24.07.2018 08:31:08] Loaded custom extension 'BotFrameworkConfiguration'  
[24.07.2018 08:31:08] Loaded custom extension 'SendGridConfiguration'  
[24.07.2018 08:31:08] Loaded custom extension 'EventGridExtensionConfig'  
[24.07.2018 08:31:08] Loaded binding extension 'IdentityExtensionConfigProvider' from 'referenced by: Method='LicznikNET  
.API.Modules.User.User.UserState', Parameter='identity'.'  
[24.07.2018 08:31:08] Loaded binding extension 'DurableTaskExtension' from 'referenced by: Method='LicznikNET.API.Module  
s.Location.Location.LocationUpdate_Activity', Parameter='ctx'.'  
[24.07.2018 08:31:09] registered EventGrid Endpoint = http://localhost:7071/admin/extensions/EventGridExtensionConfig  
[24.07.2018 08:31:09] Generating 48 job function(s)  
[24.07.2018 08:31:09] Host lock lease acquired by instance ID '0000000000000000000000000000000016B02F0D'.
```

Chapter 08: Integrating Different Components with Logic Apps

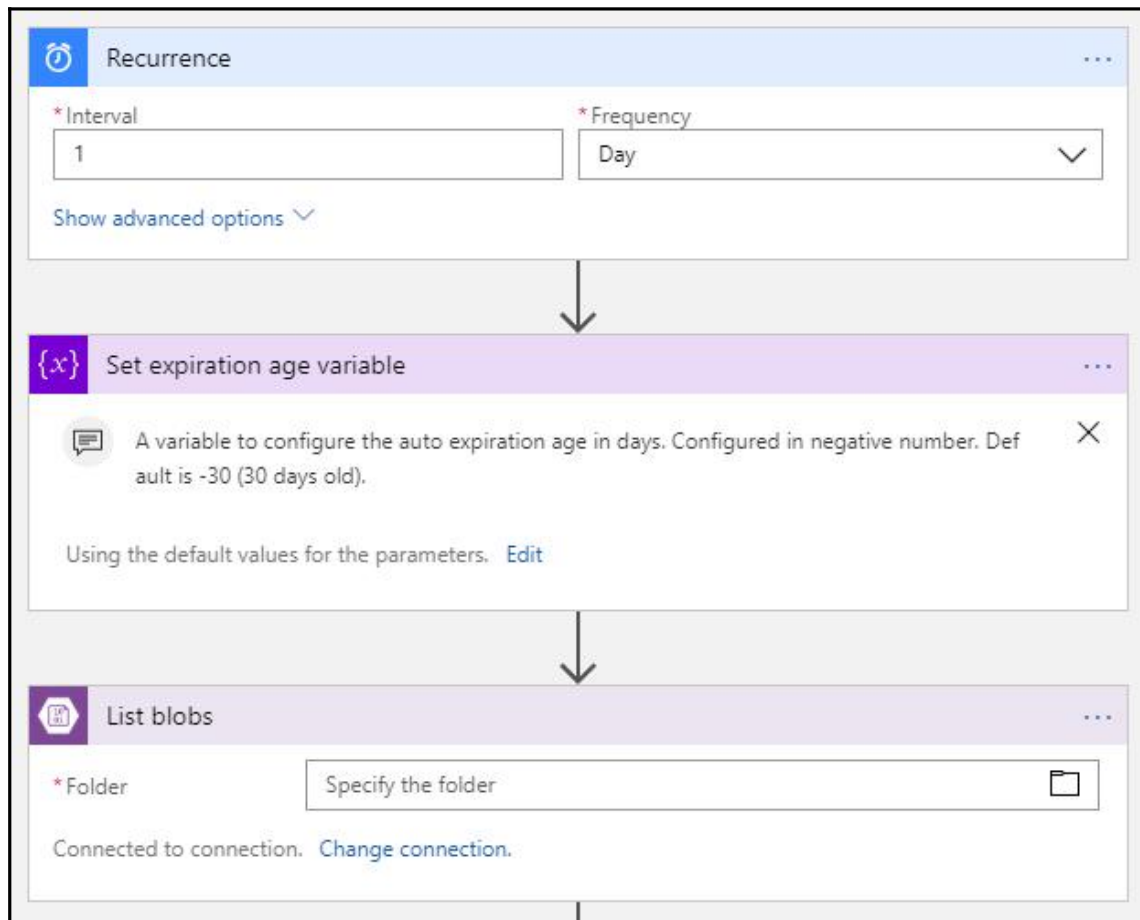

handsonazure-rg
Resource group

Search (Ctrl+/)

+ Add Edit columns Delete resource group Refresh Move Assign tags

Subscription (change) Visual Studio Enterprise Subscription ID: 94f33c43-60b5-4042-ae74-51777f... Deployments: 4 Succeeded

Tags (change) [Click here to add tags](#)

Filter by name... All types

1 of 4 items selected Show hidden types

| NAME | TYPE |
|---|------------------|
| <input checked="" type="checkbox"/> azureblob | API Connection |
| <input type="checkbox"/> CentralUSPlan | App Service plan |
| <input type="checkbox"/> handsonazurefunction | Storage account |
| <input type="checkbox"/> handsonazurelogicapp | Logic app |

Microsoft Azure

Home > New > Marketplace > Everything > Logic App > Create logic app

Create logic app

Logic App

* Name: ✓

* Subscription: ▼

* Resource group: Create new Use existing
 ▼

Location: ▼

Log Analytics: On Off

i You can add triggers and actions to your Logic App after creation.

handsonazure
Logic app

Run Trigger Refresh Edit Delete Disable Update Schema Clone Export

| | |
|---|--|
| Resource group (change) handsonazure-euw-rg | Definition 0 triggers, 0 actions |
| Location West Europe | Status Enabled |
| Subscription (change) Visual Studio Enterprise | Runs last 24 hours 0 successful, 0 failed |
| Subscription ID [REDACTED] | Integration Account --- |

Summary

| | |
|--|---|
| Trigger | Actions |
| RECURRENCE Recurrence | COUNT 0 action View in Logic Apps designer |
| FREQUENCY Runs every 3 minutes | |

Microsoft Azure

Home > Resource groups > handsonazure-rg > handsonazurelogicapp2 - Logic App Designer

handsonazurelogicapp2 - Logic App Designer
Logic app

Search (Ctrl+/)

- Overview
- Activity log
- Access control (IAM)
- Tags

DEVELOPMENT TOOLS

- Logic App Designer
- Logic App Code View

Scheduler - Add message to queue

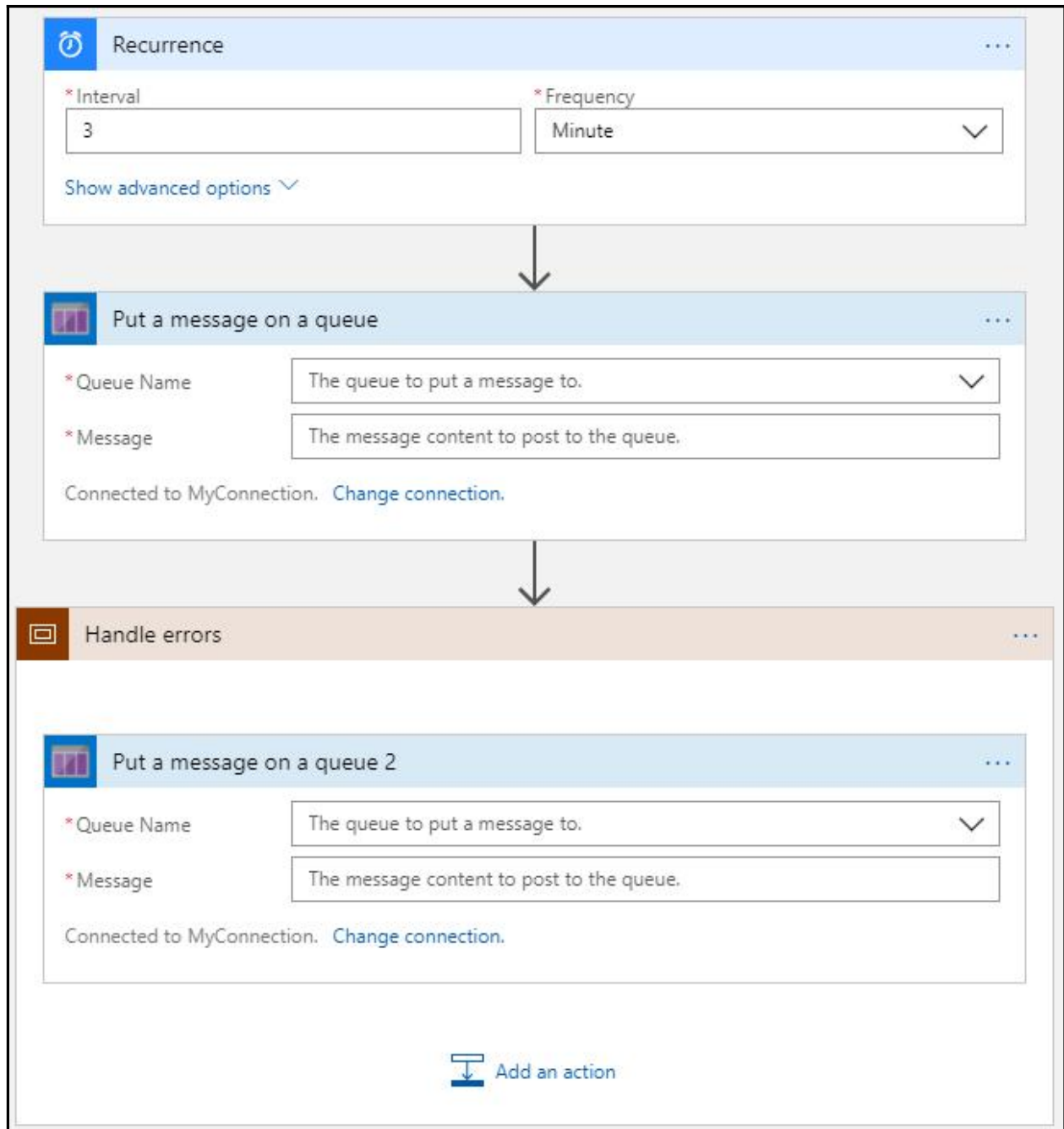

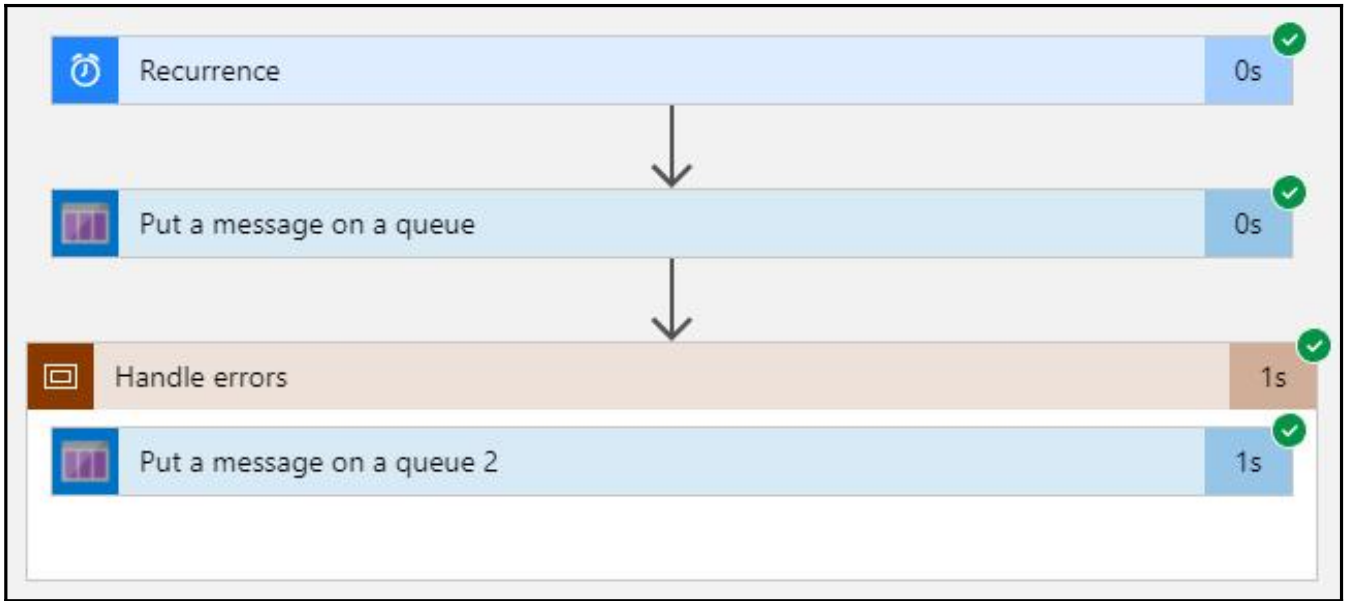

Put a message on a queue 2 0s

BadRequest.

INPUTS [Show raw inputs >](#)

Queue Name
handsonazure-error

Message

OUTPUTS [Show raw outputs >](#)

Status code
400

Headers

| Key | Value |
|-----------------------------|-------------------------------|
| Access-Control-Allow-Origin | * |
| Date | Mon, 30 Jul 2018 06:39:56 GMT |
| Content-Length | 70 |
| Content-Type | application/json |

Body

```
{  
  "message": "Please make sure you specify the message content."  
}
```

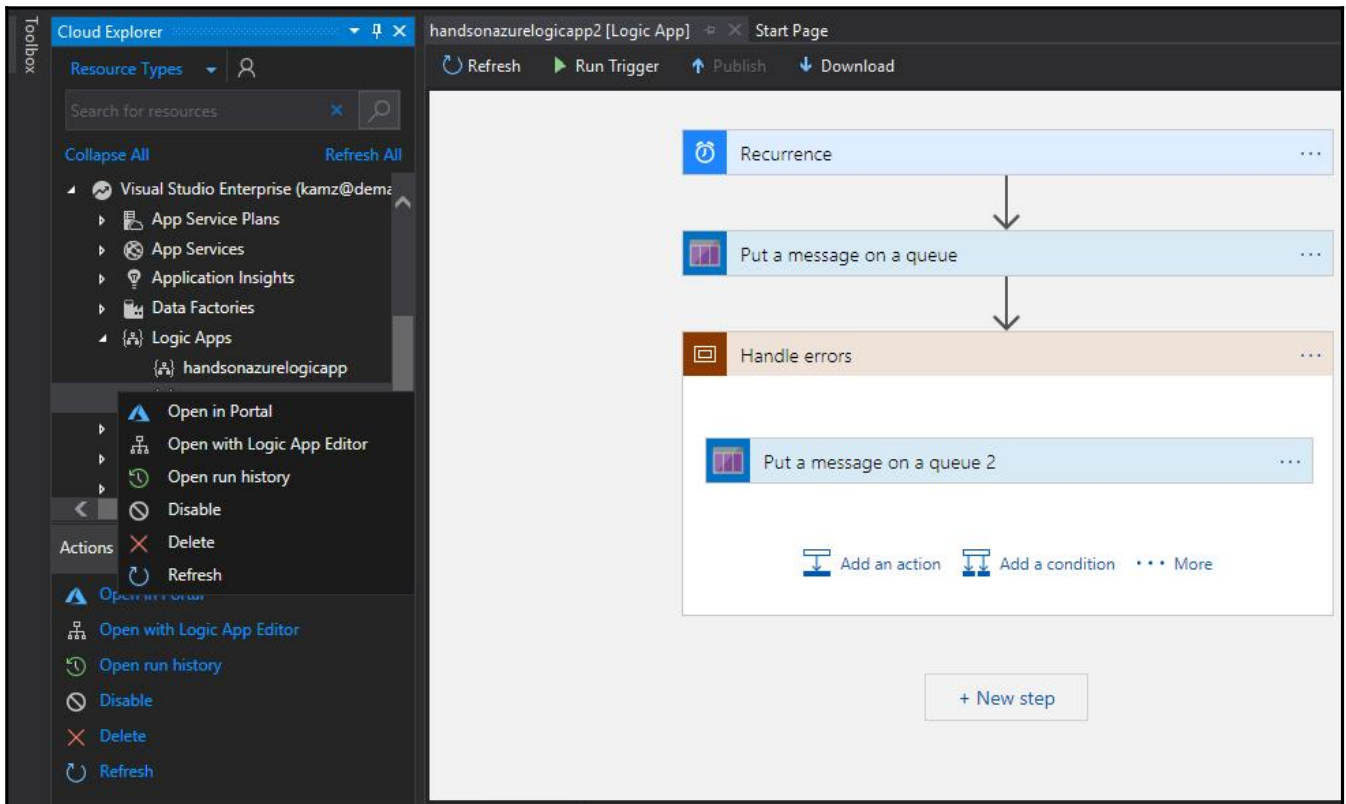
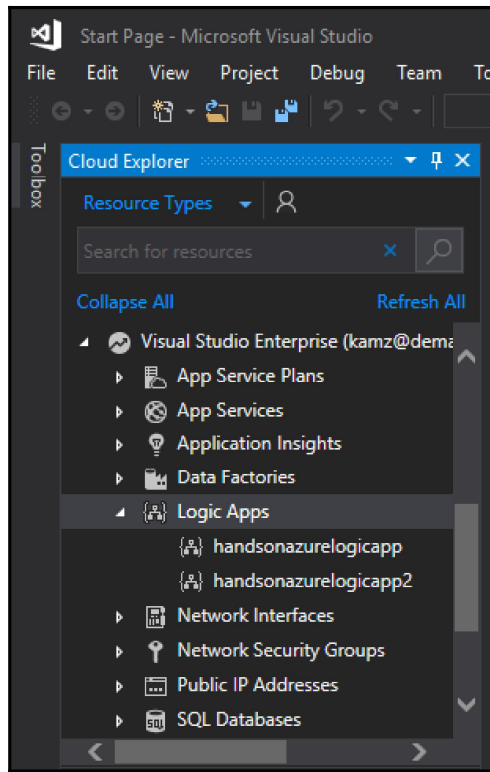

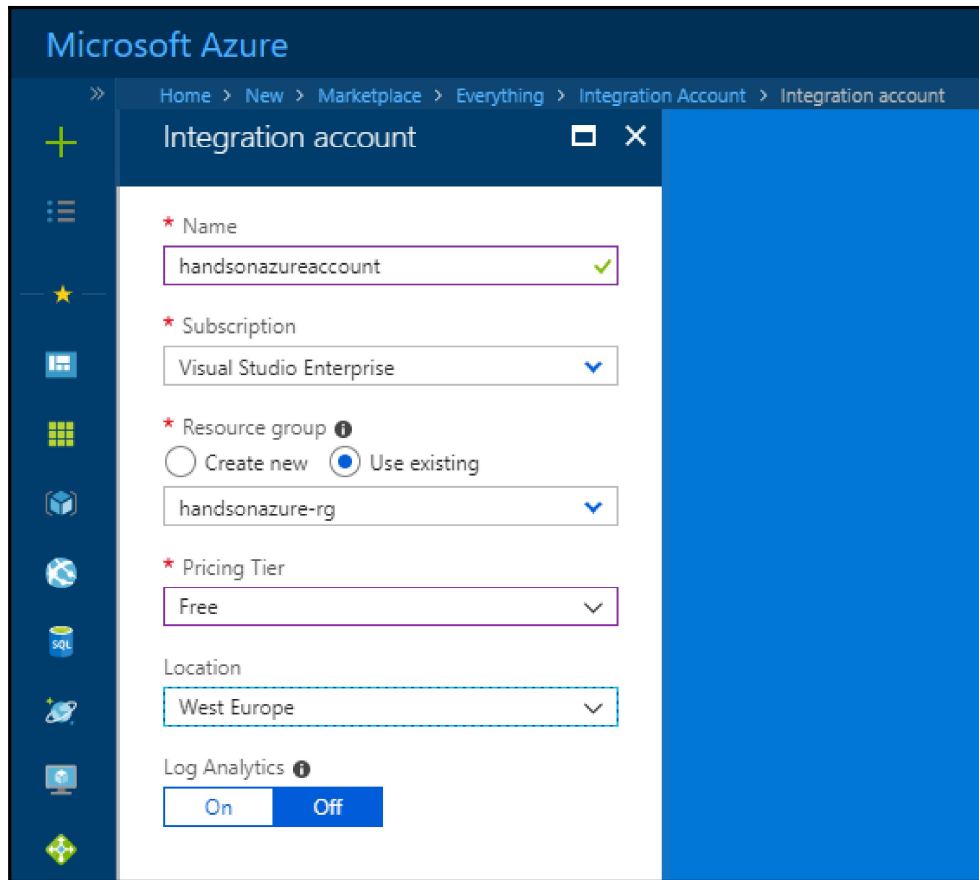

Chapter 09: Swiss Army Knife - Azure Cosmos DB

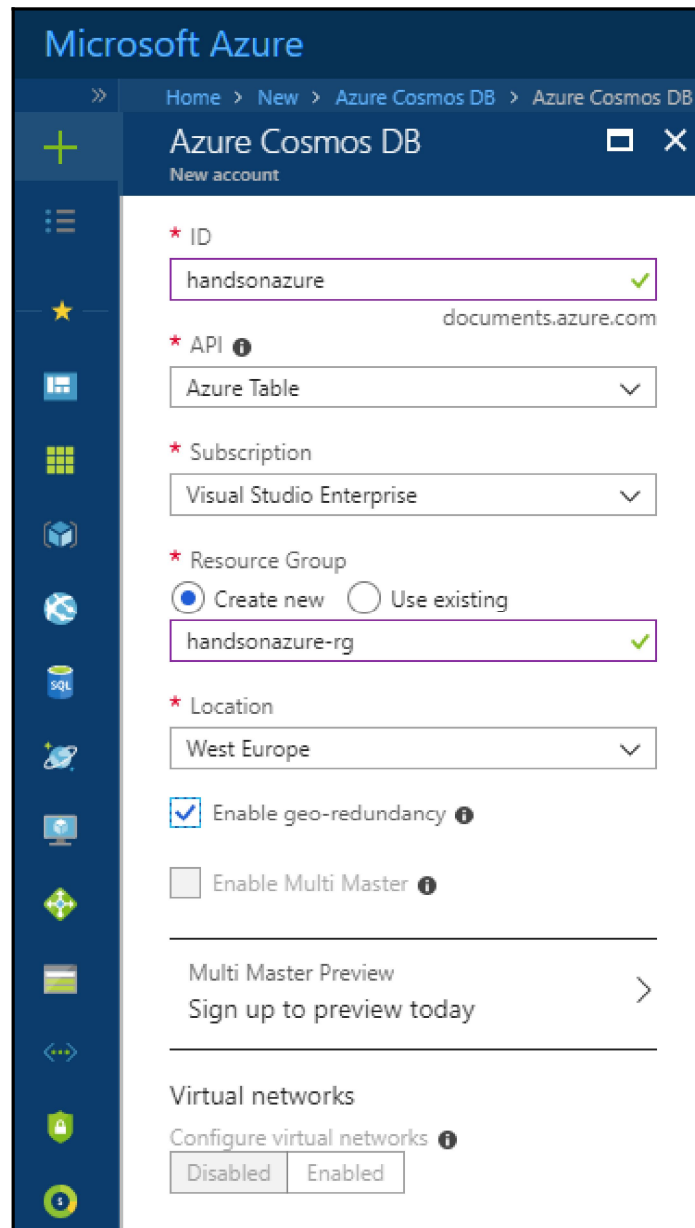

 **handonazure**
Azure Cosmos DB account

»

- [+](#) Add Collection
- [↻](#) Refresh
- [→](#) Move
- [🗑️](#) Delete Account
- [📄](#) Data Explorer
- [🌐](#) Enable geo-redundancy

Status
Online

Resource group [\(change\)](#)
handonazure-euw-rg

Subscription [\(change\)](#)
Visual Studio Enterprise

Subscription ID

Read Locations
West Europe

Write Locations
West Europe

URI
<https://handonazure.documents.azure.com:443/>



Microsoft Azure

Home > Resource groups > handsonazure-rg > handsonazure > Replicate data globally

Replicate data globally

handsonazure

Save Discard Manual Failover Automatic Failover

Click on a location to add or remove regions from your Azure Cosmos DB account.

* Each region is billable based on the throughput and storage for the account. [Learn more](#)







The map displays several regions marked with blue hexagons, indicating they are selected for replication. These include West Europe, France Central, South India, Canada Central, and Japan East.

WRITE REGION

West Europe

READ REGIONS

| | |
|----------------|---|
| France Central |  |
| South India |  |
| Canada Central |  |
| Japan East |  |

[Add new region](#)



handonazure - Quick start

Azure Cosmos DB account

»

Congratulations! Your Azure Cosmos DB account was created.

Now, let's connect to it using a sample app:

Choose a platform

 .NET

 .NET Core

 Xamarin

 Java

 Node.js

 Python

1 Add a collection

"Items" collection has been created with 10GB storage capacity and 400 [Request Units per second \(RU/s\)](#) throughput capacity, for up to 400 reads/sec. Estimated hourly bill: \$0.033 USD

2 Download and run your .NET app

We created a sample .NET app connected to your "Items" collection. Download, extract, build and run the app.

[Download](#)

3 Work with data

Query and edit your data, add stored procedures, and more using Data Explorer.

[Open Data Explorer](#)

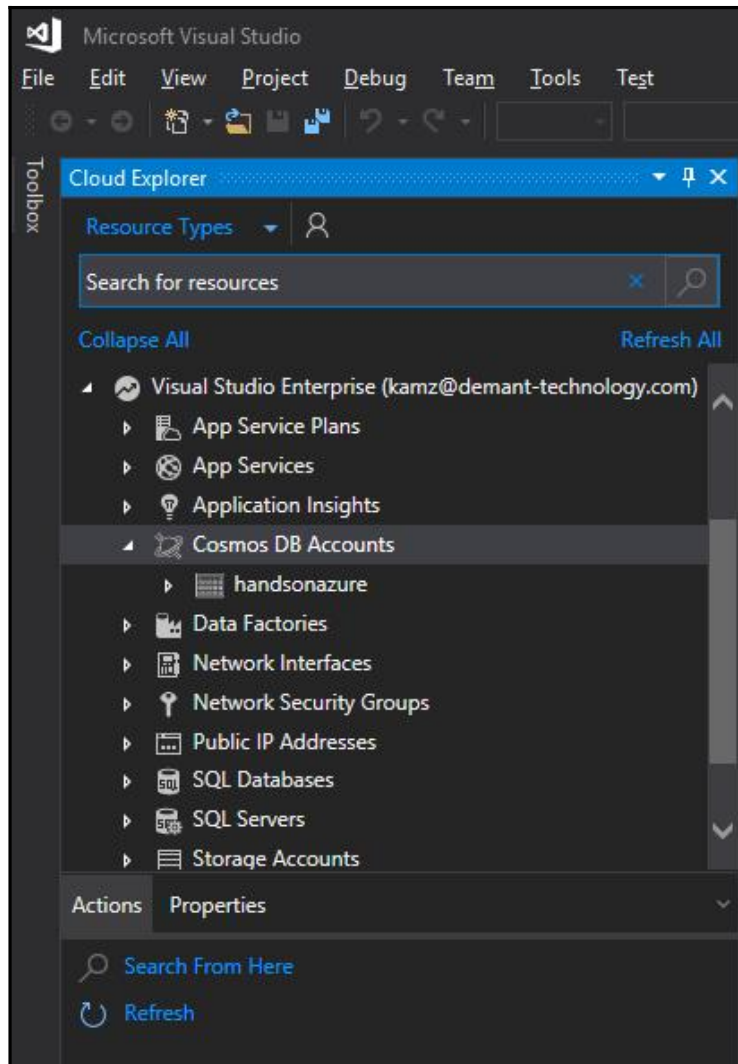

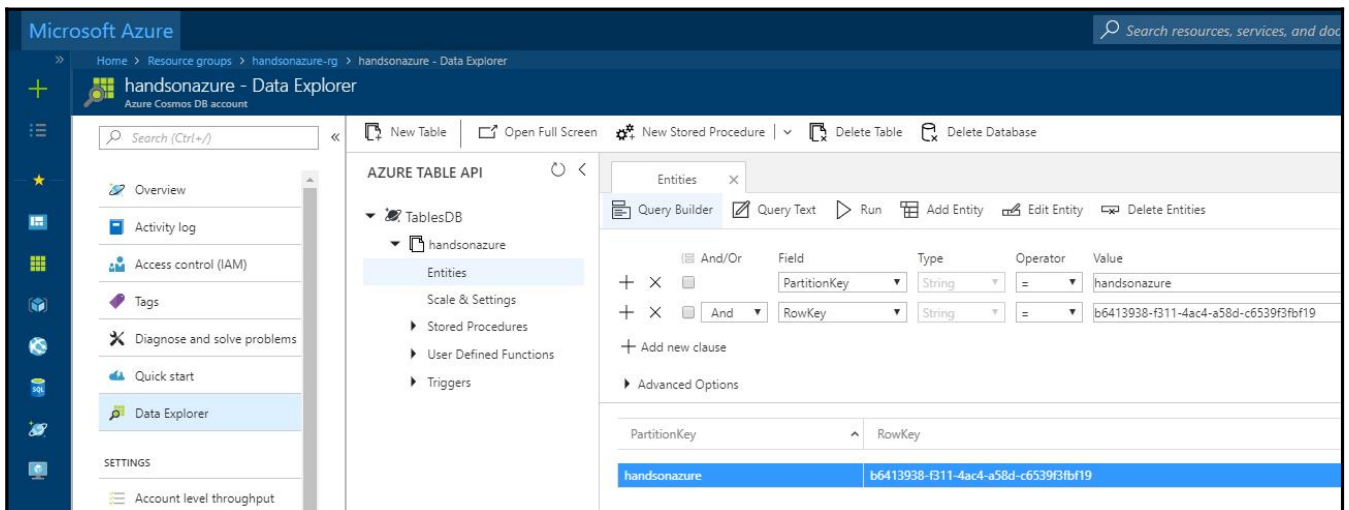
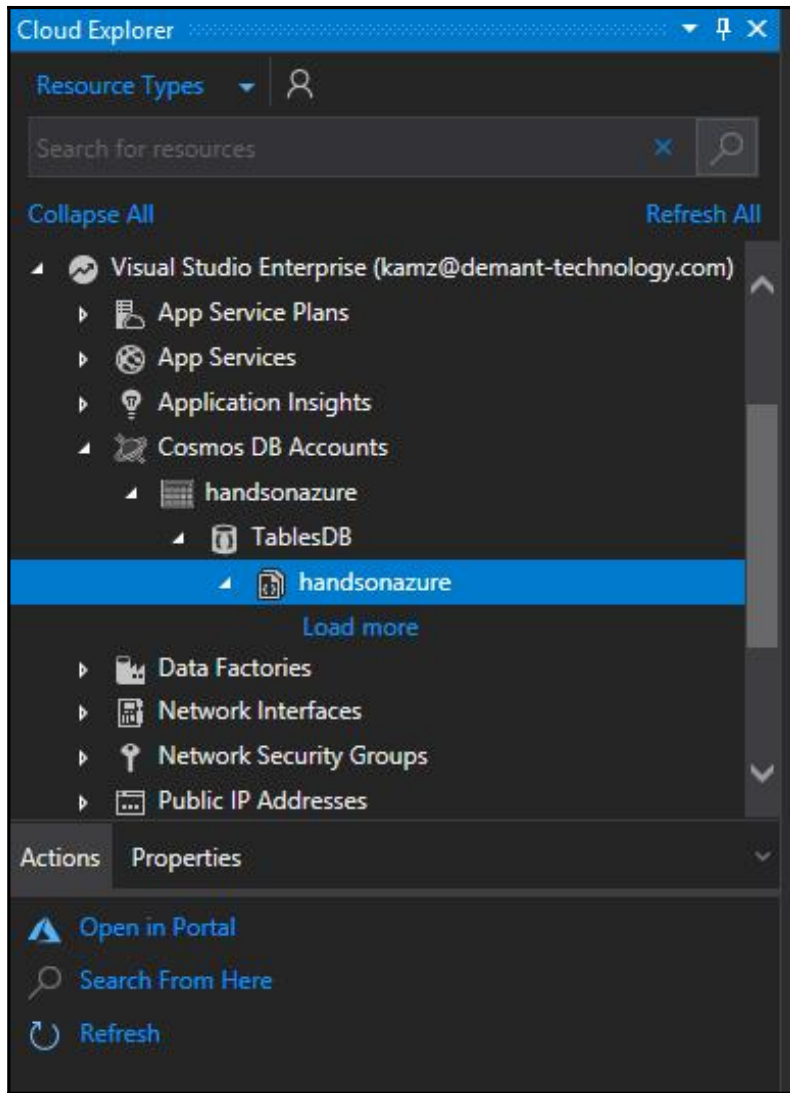

Microsoft Azure

Home > Resource groups > handsonazure-rg > handsonazure - Data Explorer

handsonazure - Data Explorer
Azure Cosmos DB account

Search (Ctrl+/)

New Table | Open Full Screen | New Stored Procedure | Delete Table | Delete Database

AZURE TABLE API

- TablesDB
 - handsonazure
 - Entities
 - Scale & Settings**
 - Stored Procedures
 - User Defined Functions
 - Triggers

Entities | Scale & Settings X

Save | Discard

Scale

Storage capacity
Fixed

Throughput (400 - 10 000 RU/s)
400

Estimated spend (USD): **\$0.032 hourly / \$0.77 daily.**
[Contact support for more than 10 000 RU/s](#)

Settings

Microsoft Azure

Home > handsonazure - Default consistency

handsonazure - Default consistency
Azure Cosmos DB account

Search resources

Search (Ctrl+/)

Save | Discard

STRONG | **BOUNDED STALENESS** | SESSION | CONSISTENT PREFIX | EVENTUAL

Maximum Lag (Time)

| Days | Hours | Minutes | Seconds | Maximum Lag (Operations) |
|------|-------|---------|---------|--------------------------|
| 1 | 0 | 0 | 0 | 1000000 ✓ |

Bounded staleness consistency is most frequently chosen by globally distributed applications expecting low write latencies but total global order

Understand Bounded Staleness consistency

Unlike strong consistency which is scoped to a single region, you can choose bounded staleness consistency with any number of read regions (along with a subscribe/queueing etc.

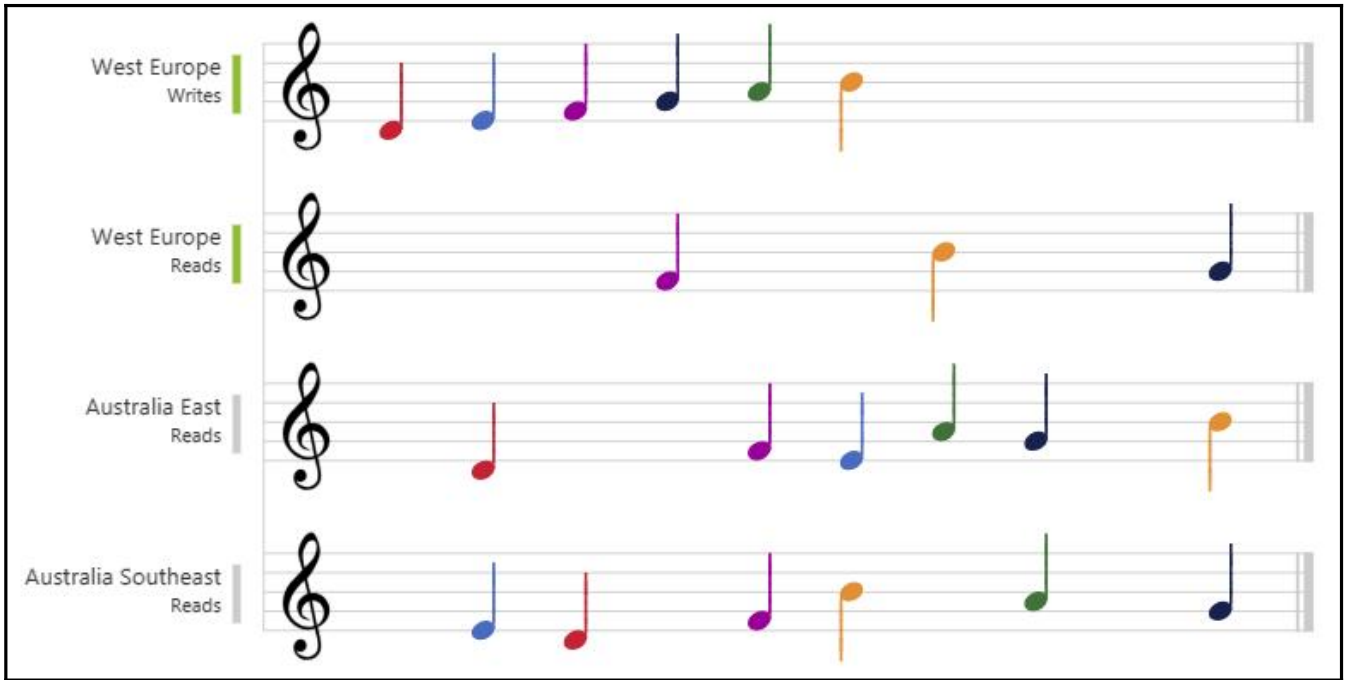

Microsoft Azure

Home > Resource groups > handsonazure-rg > handsonazure - Account level throughput

handsonazure - Account level throughput
Azure Cosmos DB account

Search (Ctrl+/)

Save Discard

Overview
Activity log
Access control (IAM)
Tags
Diagnose and solve problems
Quick start
Data Explorer

SETTINGS

Account level throughput
Replicate data globally

You can optionally provision throughput at the account level to be whether you have tables created or not. The estimate below is app

Provision Throughput

ON OFF

Throughput (50 000 - 1 000 000 RU/s)

50000 ✓ - +

Estimated spend (USD): 4 hourly / 96 daily.

New Database

* Database id ⓘ

Provision throughput ⓘ

* Throughput (400 - 1 000 000 RU/s) ⓘ

Estimated spend (USD): \$4.00 hourly / \$96.00 daily.

Microsoft Azure

Home > Resource groups > handsonazure-rg > handsonazure > Add Azure Function

Add Azure Function

i Create an Azure Function with an Azure Cosmos DB trigger that listens to the change feed of a collection. Click here to read more about Azure Functions and Azure Cosmos DB integration.

- 1** Select table
Select the table to monitor for changes. Your Azure Function will receive batches of changed items to be processed.
- 2** Create Azure Function
Select an Azure Function app

* Name your Azure Function
 ✓
Function language

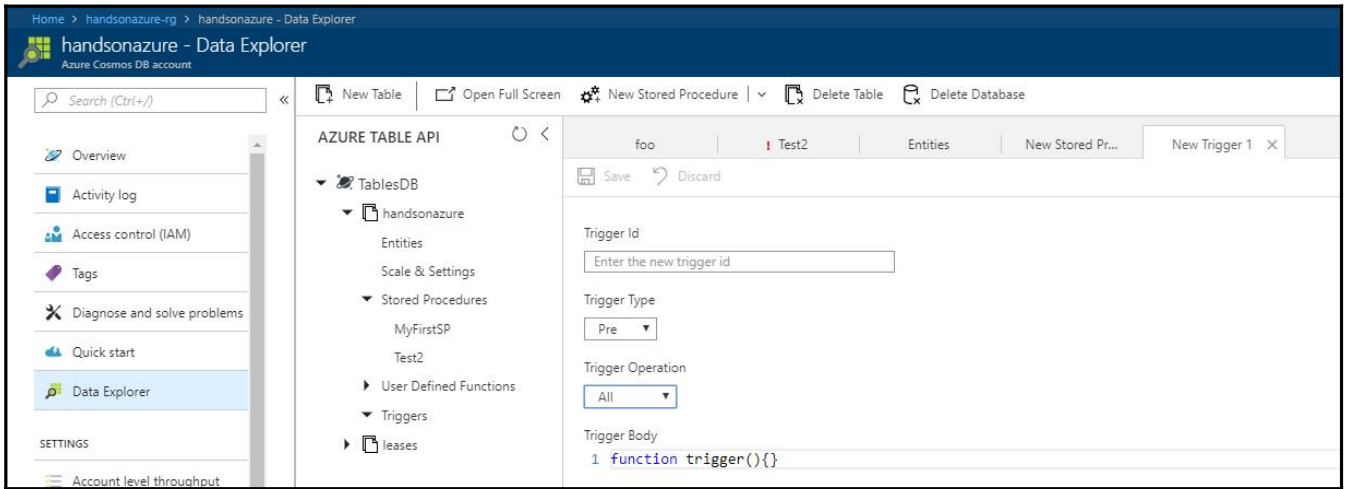
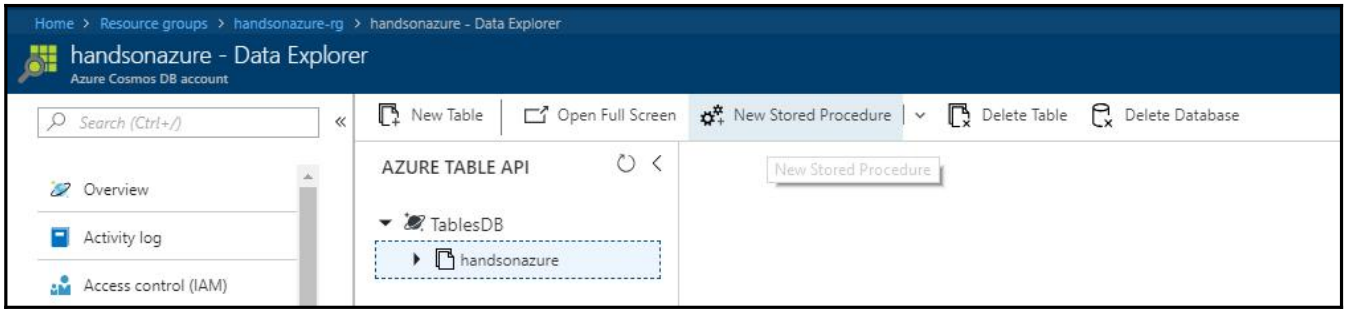

Chapter 10: Reactive Architecture with Event Grid

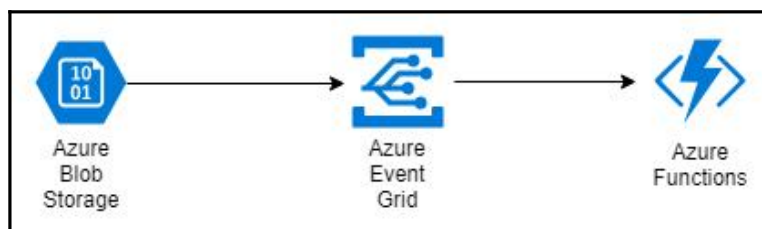
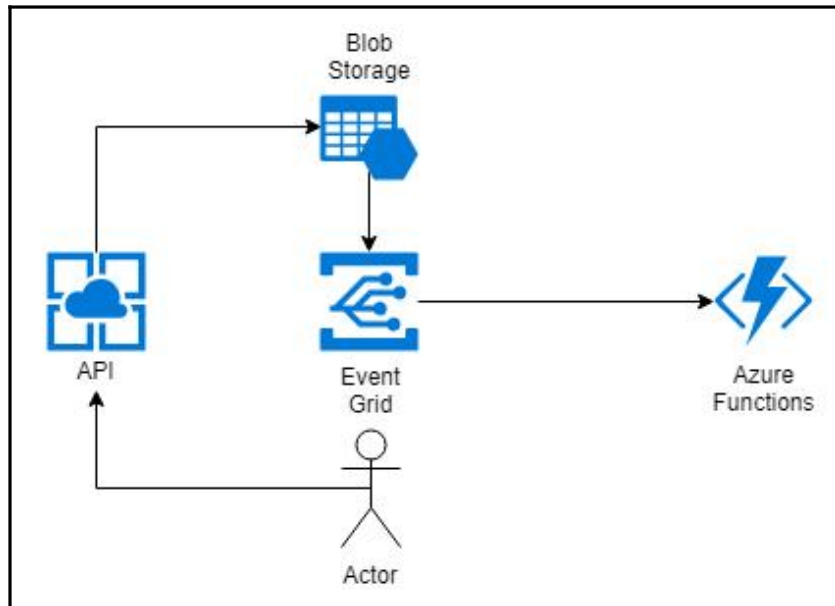
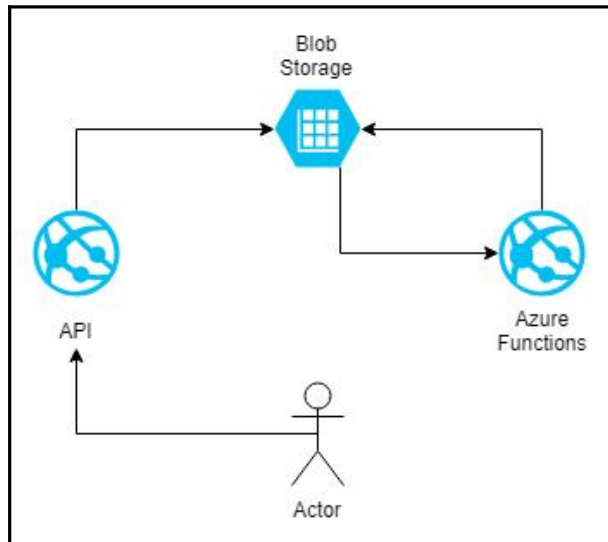

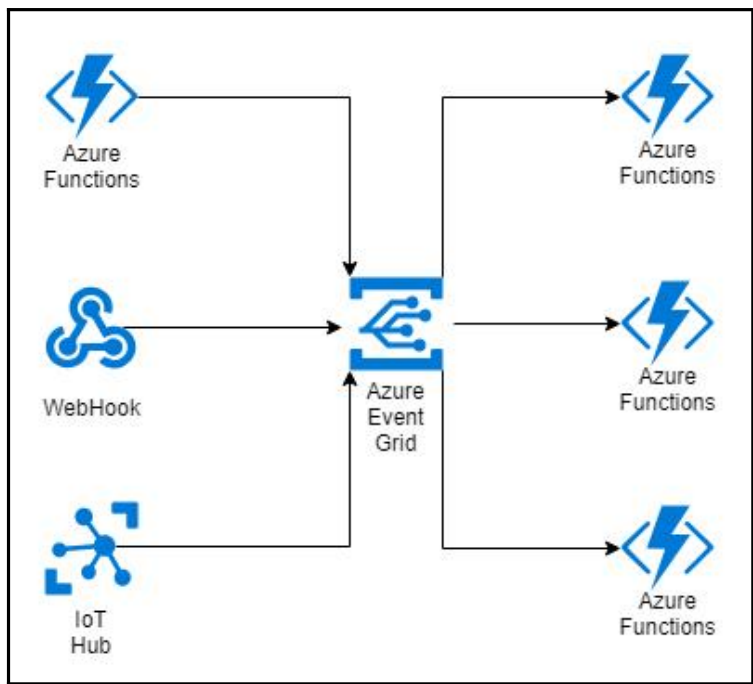
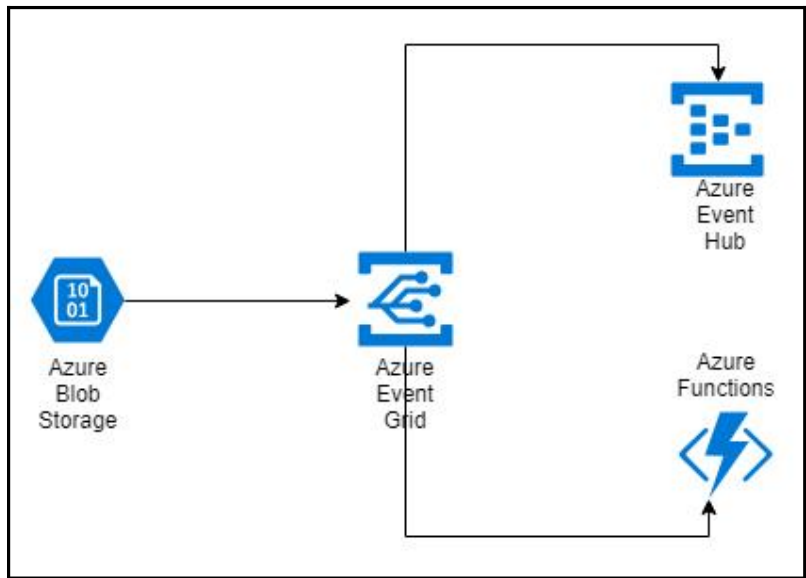

Microsoft Azure

Home > New > Marketplace > Everything > Event Grid Topic >

Create Topic

Event Grid

* Name
handsonazure-eventgrid

* Subscription
Visual Studio Enterprise

* Resource group
 Create new Use existing
handsonazure-rg

* Location
West Europe

Microsoft Azure Search resources, services, and docs kamz@demant-DEMANT GROUP

Home > Resource groups > handsonazure-rg > handsonazure-eventgrid

handsonazure-eventgrid

Event Grid Topic

Search (Ctrl+/)

- Overview
- Activity log
- Access control (IAM)
- Tags

SETTINGS

- Access keys
- Locks
- Automation script

SUPPORT + TROUBLESHOOTING

- New support request

[+ Event Subscription](#)
[Delete](#)
[Refresh](#)

Resource group (change) **handsonazure-rg**
 Topic Endpoint <https://handsonazure-eventgrid.westeurope-1.event...>

Status **Active**

Location **West Europe**

Subscription (change) **Visual Studio Enterprise**

Subscription ID **94f33c43-60b5-4042-ae74-51777f69f99a**



No Event Subscriptions Found!

Enable event based programming in Azure by using Event Subscriptions to connect your resources. Connect native event sources to event handlers, or bring your own. [Learn more about Azure Event Grid.](#)

[Create one](#)

handsonazure - Access keys

Event Grid Topic

Access keys are used to authenticate an application publishing events to this Azure Event Grid Topic. We recommend regenerating your keys regularly and storing them securely. You are

| NAME | KEY |
|-------|---------------------|
| Key 1 | [Redacted] /FedzLM= |
| Key 2 | [Redacted] MV0s7kU= |

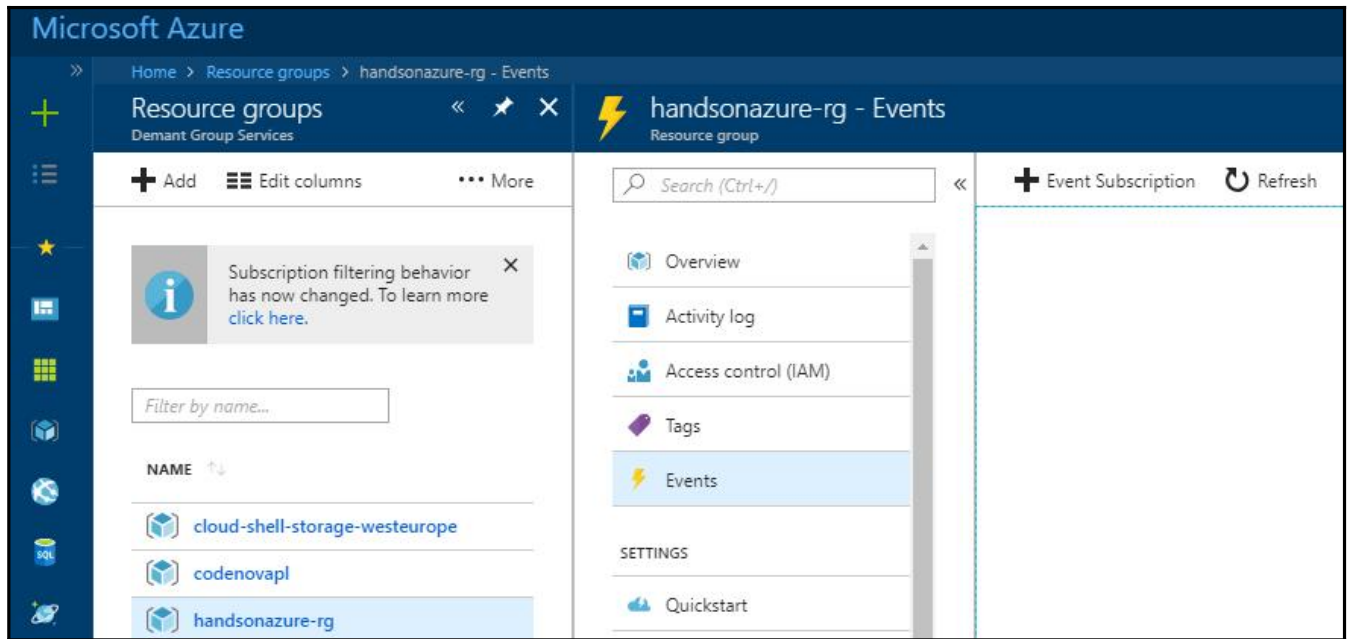

Microsoft Azure

Home > Resource groups > handsonazure-rg - Events > Create Event Subscription

Create Event Subscription

Event Grid

Create **Advanced Editor**

Event Subscriptions listen for events emitted by the topic resource and send them to the endpoint resource. [Learn more](#)

TOPIC DETAILS

Pick a topic resource for which events should be generated and pushed. [Learn more](#)

Topic Type Resource Group

Topic Resource handsonazure-rg

EVENT TYPES

Pick which event types get pushed to your destination. [Learn more](#)

Subscribe to all event types

ENDPOINT DETAILS

Pick an event handler to receive your events. [Learn more](#)

Endpoint Type Web Hook [\(change\)](#)

Endpoint Select an endpoint

EVENT SUBSCRIPTION DETAILS

Name

Event Schema Event Grid Schema

FILTERS

Subject Begins With

Subject Ends With

Labels + Add Label

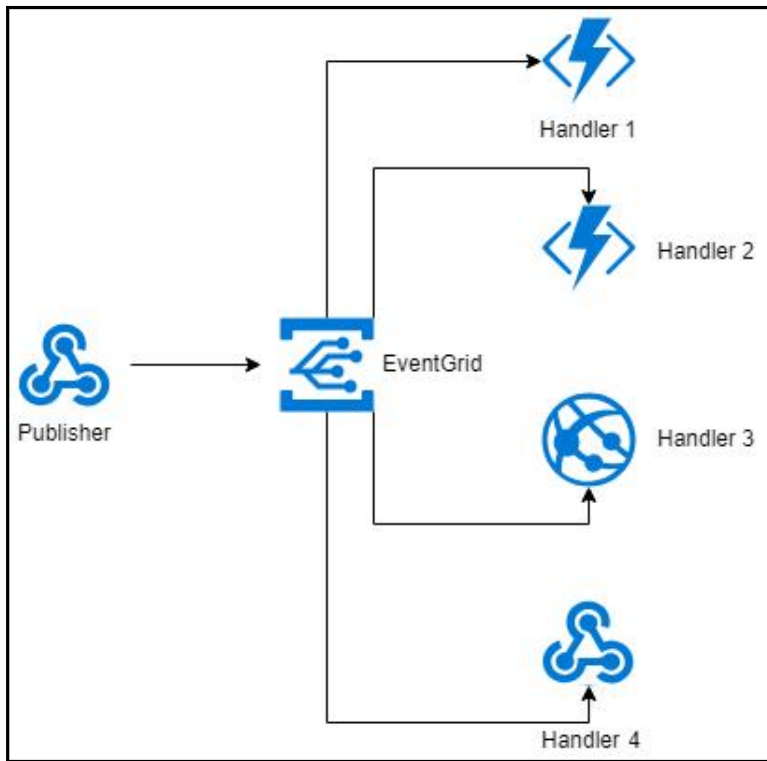

Microsoft Azure

Home > Resource groups > handsonazure-rg > handsonazure-eventgrid > Create Event Subscription

Create Event Subscription

Event Grid

Create **Advanced Editor**

Event Subscriptions listen for events emitted by the topic resource and send them to the endpoint resource. [Learn more](#)

TOPIC DETAILS

Pick a topic resource for which events should be generated and pushed. [Learn more](#)

Topic Type  Event Grid Topic

Topic Resource [handsonazure-eventgrid](#)

EVENT TYPES

Pick which event types get pushed to your destination. [Learn more](#)

Subscribe to all event types

ENDPOINT DETAILS

Pick an event handler to receive your events. [Learn more](#)

Endpoint Type  Web Hook [\(change\)](#)

Endpoint [Select an endpoint](#)

EVENT SUBSCRIPTION DETAILS

Name ✓

Event Schema ▼

FILTERS

Subject Begins With

Subject Ends With

Labels  Add Label

Create

Microsoft Azure

Home > Resource groups > handsonazure-rg > handsonazure-function

handsonazure-function

Function Apps

Search: "handsonazure-function" ✖

Visual Studio Enterprise

- Function Apps
- handsonazure-function
 - Functions +
 - HttpTriggerCSharp1
 - Integrate
 - Manage
 - Monitor
 - Proxies

Choose a template below or [go to the quickstart](#)

Search: eve... ✖ Language: All Scenario: All

Event Grid trigger

A function that will be run whenever an event grid receives a new event

C# JavaScript

Microsoft Azure

Home > Resource groups > handsonazure-rg > handsonazure-function - EventGridTriggerCSharp1

handsonazure-function - EventGridTriggerCSharp1

Function Apps

Search: "handsonazure-function" ✖

Visual Studio Enterprise

- Function Apps
- handsonazure-function
 - Functions
 - EventGridTriggerCSharp1
 - Integrate

run.csx Save Run Add Event Grid subscription

```

1 #r "Newtonsoft.Json"
2
3 using Newtonsoft.Json;
4 using Newtonsoft.Json.Linq;
5
6 public static void Run(JObject eventGridEvent, TraceWriter log)
7 {
8     log.Info(eventGridEvent.ToString(Formatting.Indented));
9 }
10

```

Create Event Subscription
Event Grid

* Name
handsonazure-function ✓

Topic Type
Event Grid Topics

Subscription
Visual Studio Enterprise

Resource group
Use existing
handsonazure-rg

* Instance
handsonazure-eventgrid

Subscribe to all event types

Subscriber Type
Web Hook

* Subscriber Endpoint
https://handsonazure-function.azurewebsites.net/admin/extensions/EventGridExtensionConfig?...

Prefix Filter
Sample-workitems/{name} Optional

Suffix Filter
.jpg Optional

Home > Resource groups > handsonazure-rg > handsonazure-eventgrid

handsonazure-eventgrid

Event Grid Topic

Search (Ctrl+)

- Overview
- Activity log
- Access control (IAM)
- Tags

SETTINGS

- Access keys
- Locks
- Automation script

SUPPORT + TROUBLESHOOTING

- New support request

+ Event Subscription
🗑️ Delete
🔄 Refresh

Resource group (change)
handsonazure-rg

Status
Active

Topic Metrics

PUBLISH SUCCEEDED

3

PUBLISH FAILED

3

UNMATCHED

1

12

Search to filter items...

| NAME | ENDPOINT TYPE |
|-----------------------|---------------|
| HandsOnSubscription | WebHook |
| handsonazure-function | WebHook |

Chapter 11: Using Azure Storage - Tables, Queues, Files, and Blobs

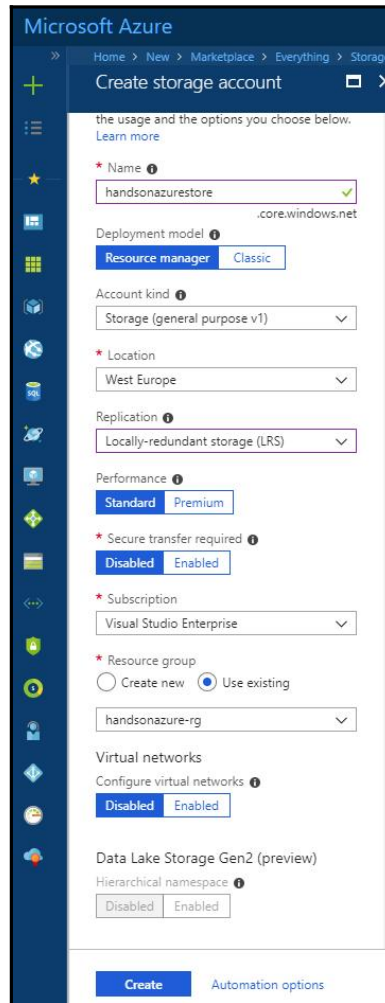

Microsoft Azure Search resources, services, and docs kamz@demant-techn... DEMANT GROUP SERVICES

Home > Resource groups > handsonazure-rg > handsonazurestore

handsonazurestore

Storage account

Search (Ctrl+/)

Open in Explorer Move Delete Refresh

| | |
|--|---------------------------------|
| Resource group (change) | Performance |
| handsonazure-rg | Standard |
| Status | Replication |
| Primary: Available | Locally-redundant storage (LRS) |
| Location | Account kind |
| West Europe | Storage (general purpose v1) |
| Subscription (change) | |
| Visual Studio Enterprise | |
| Subscription ID | |
| Tags (change) | |
| Click here to add tags | |

Overview
Activity log
Access control (IAM)
Tags
Diagnose and solve problems
Storage Explorer (preview)

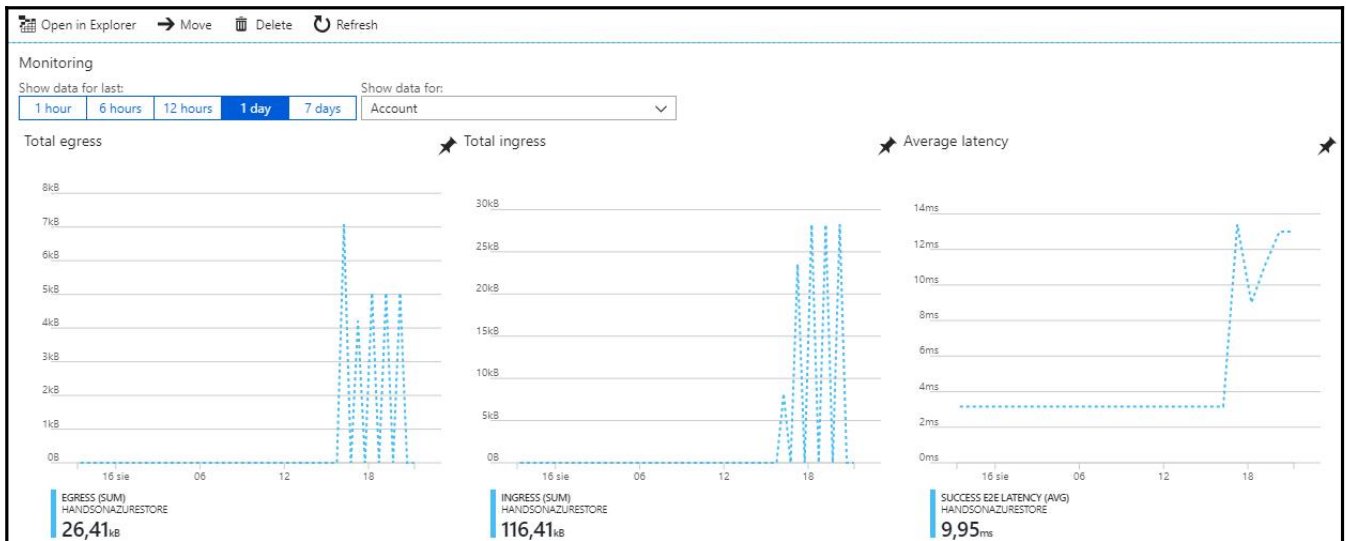

Home > Resource groups > handsonazure-rg > handsonazurestore - Tables

handsonazurestore - Tables

Storage account

Search (Ctrl+/)

- Soft delete
- Azure CDN
- Add Azure Search

FILE SERVICE

- Files

+ Table Refresh Delete tables

Check out premium Table experience with Azure Cosmos DB →

Storage account: handsonazurestore

Search tables by prefix

TABLE

You don't have any tables yet.

Home > Resource groups > handsonazure-rg > handsonazurestore - Tables

handsonazurestore - Tables

Storage account

Search (Ctrl+/)

- Soft delete
- Azure CDN
- Add Azure Search

FILE SERVICE

- Files

+ Table Refresh Delete tables

Check out premium Table experience with Azure Cosmos DB →

Storage account: handsonazurestore

Search tables by prefix

| TABLE | URL |
|--------|---|
| orders | https://handsonazurestore.table.core.windows.net/... .. |

Microsoft Azure Storage Explorer

File Edit View Help

EXPLORER

Search for resources

Collapse All Refresh All

- Blob Containers
- Queues
- Tables
 - AzureWebJobsHostLogs201
 - AzureWebJobsHostLogs201
 - AzureWebJobsHostLogscor
 - Company
 - CompanyCodeMap

orders x

Query Import Export Add Edit Select All Column Options Delete Table Statistics Refresh

| PartitionKey | RowKey | Timestamp | Created | CustomerId |
|--------------|--------------------------------------|--------------------------|--------------------------|--------------|
| orders | 3d28b28f-f5f5-439a-a18e-22d2c3c4b00f | 2018-08-18T10:04:29.613Z | 2018-08-18T10:04:29.594Z | Customer-001 |
| orders | 5d7074c9-ee42-4277-ae10-145b7de15fd5 | 2018-08-18T10:04:25.943Z | 2018-08-18T10:04:25.929Z | Customer-001 |
| orders | aacc6edf-6c69-414f-9076-e124097979c1 | 2018-08-18T10:04:19.447Z | 2018-08-18T10:04:19.429Z | Customer-001 |
| orders | adb64717-d244-4ee1-a2ae-74a863369ad0 | 2018-08-18T10:04:00.863Z | 2018-08-18T10:04:00.843Z | Customer-001 |
| orders | dab7e829-38c9-47a6-bda3-a8f0e9c4496a | 2018-08-18T09:57:34.057Z | 2018-08-18T09:57:34.040Z | Customer-001 |

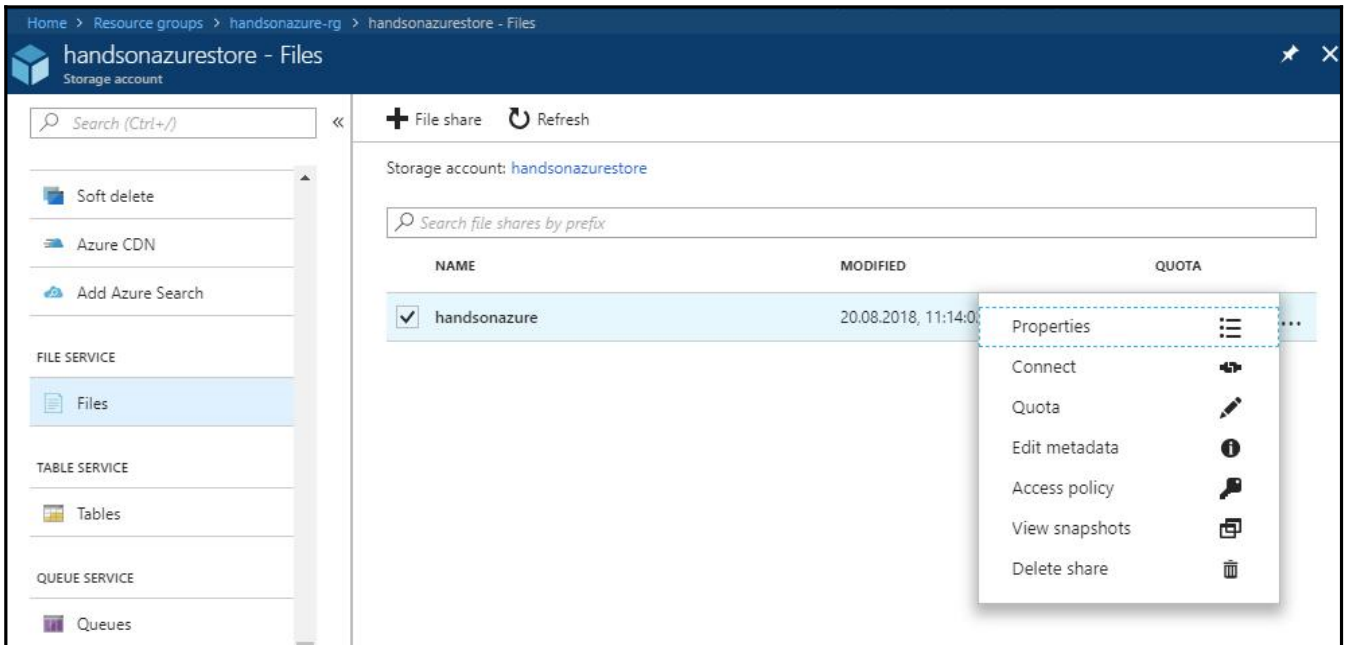
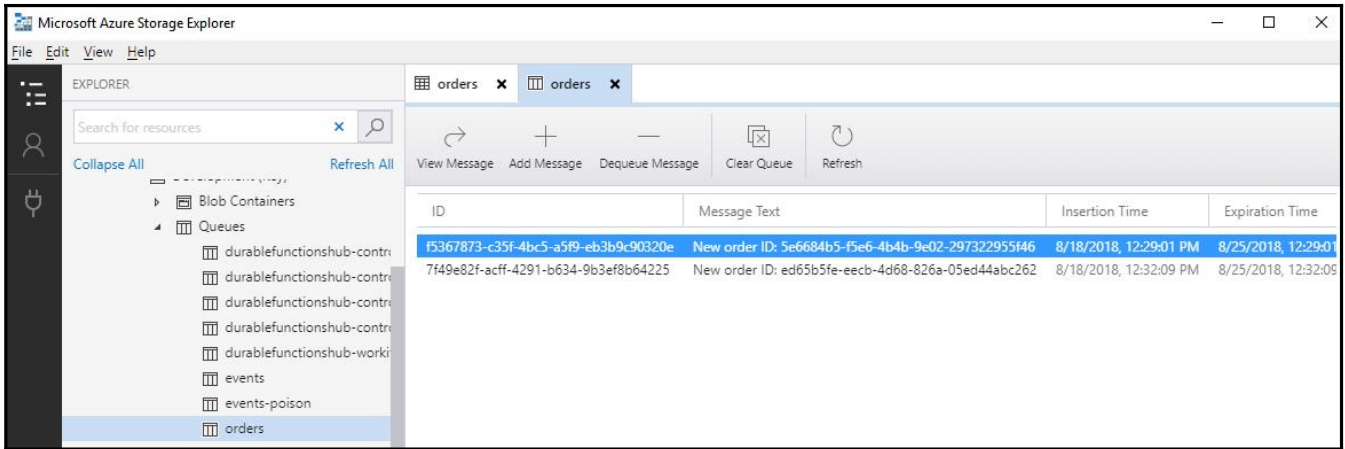

Home > Resource groups > handsonazure-rg > handsonazurestore - Files > handsonazure

handsonazure

File share

Search (Ctrl+*/*)

Connect Upload Add directory Refresh

Backup (Preview) is not enabled for this file share. [Click here](#)

Location: [handsonazure](#)

Search files by prefix

| NAME |
|-----------------|
| 11047_01_01.PNG |
| 11047_01_02.PNG |
| 11047_01_03.PNG |
| 11047_01_04.PNG |
| 11047_01_05.PNG |
| 11047_01_06.PNG |
| 11047_01_07.PNG |
| 11047_01_08.PNG |
| 11047_01_09.PNG |
| 11047_01_10.PNG |
| 11047_01_11.PNG |
| 11047_01_12.PNG |

Overview

SETTINGS

- Access policy
- Properties

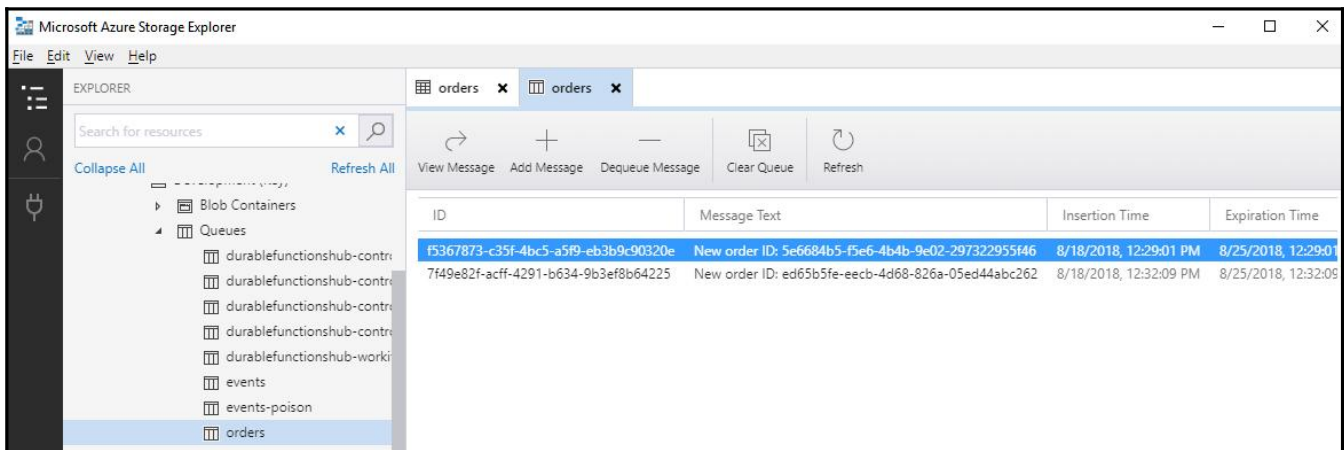
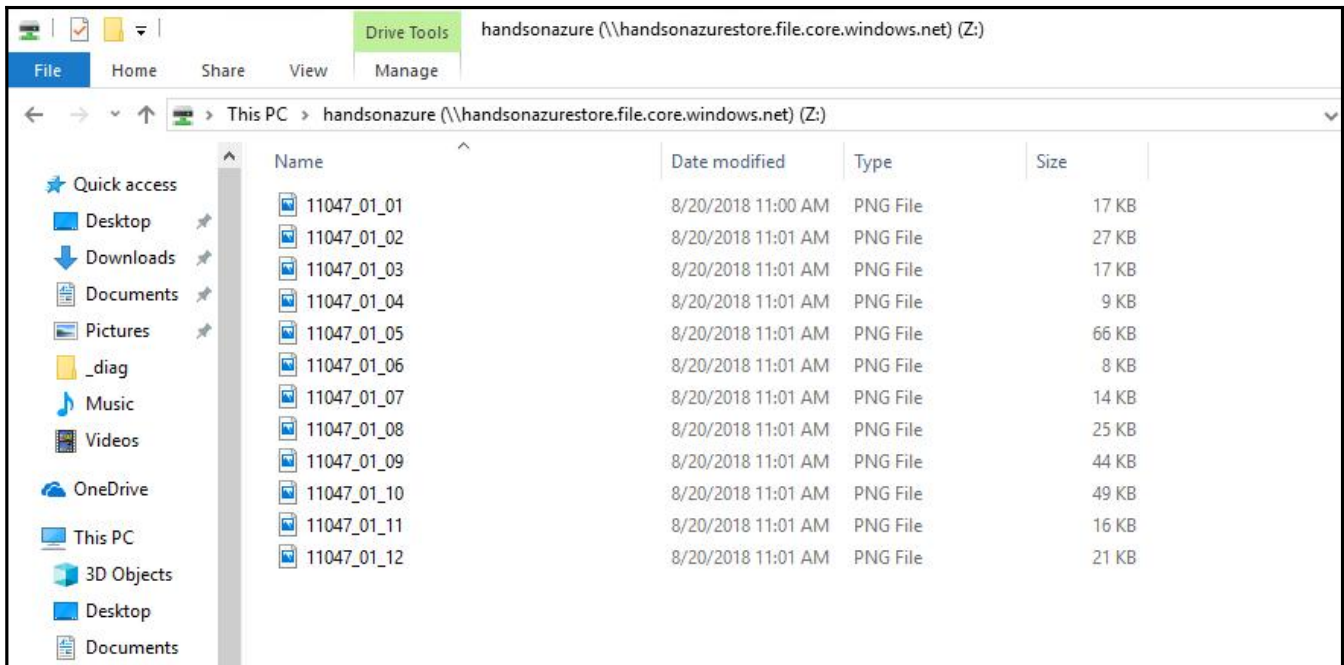

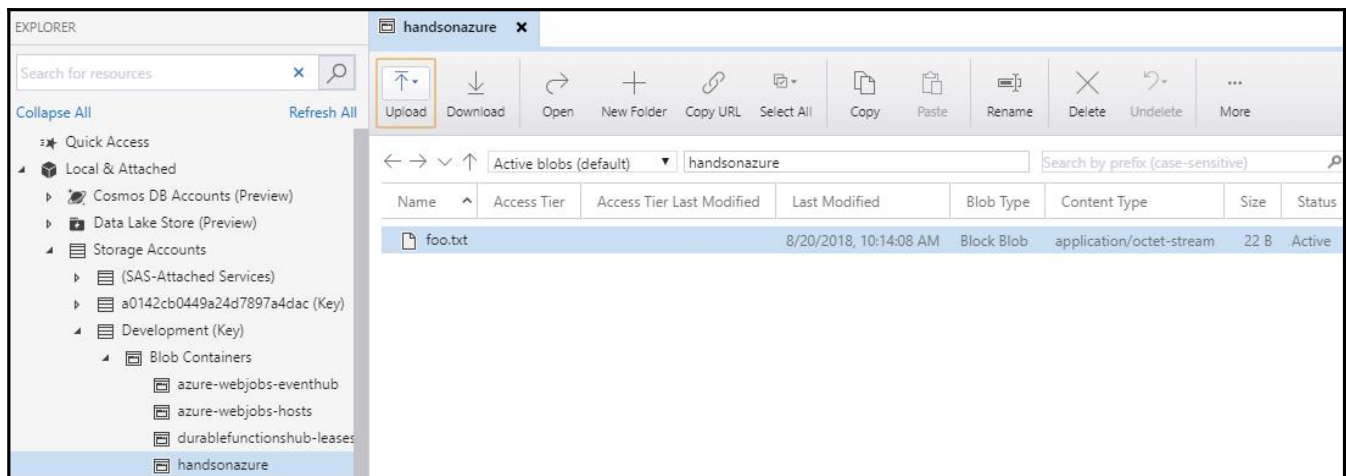
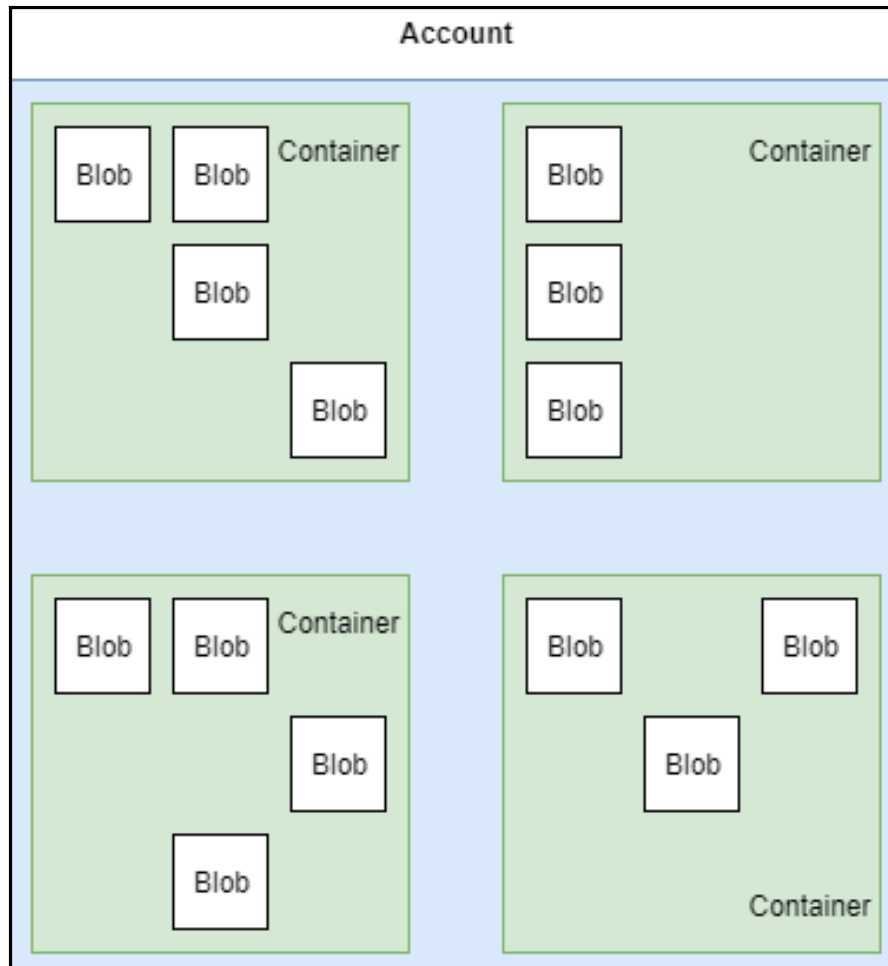

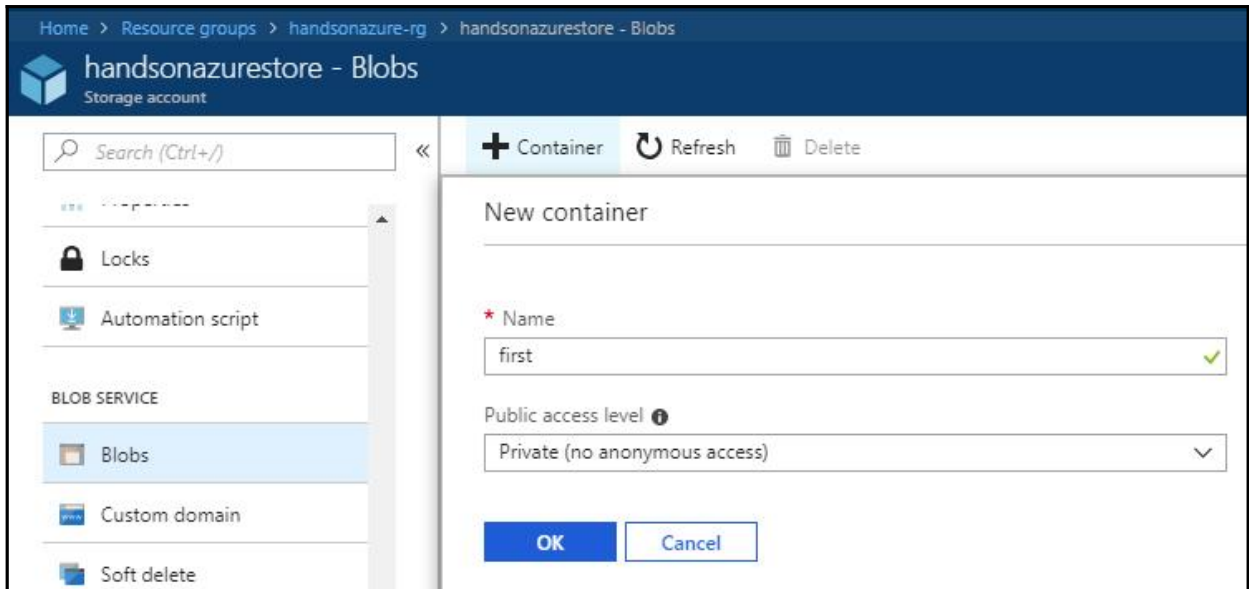
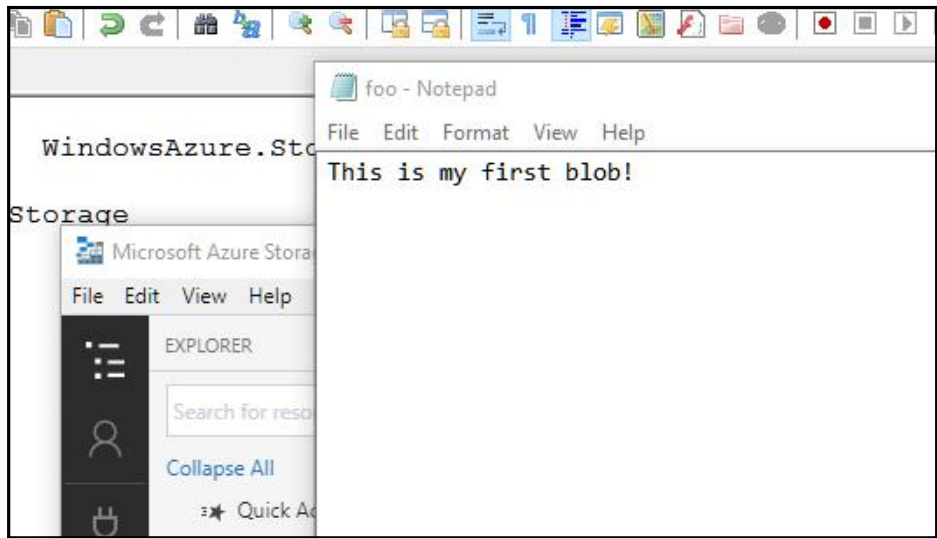

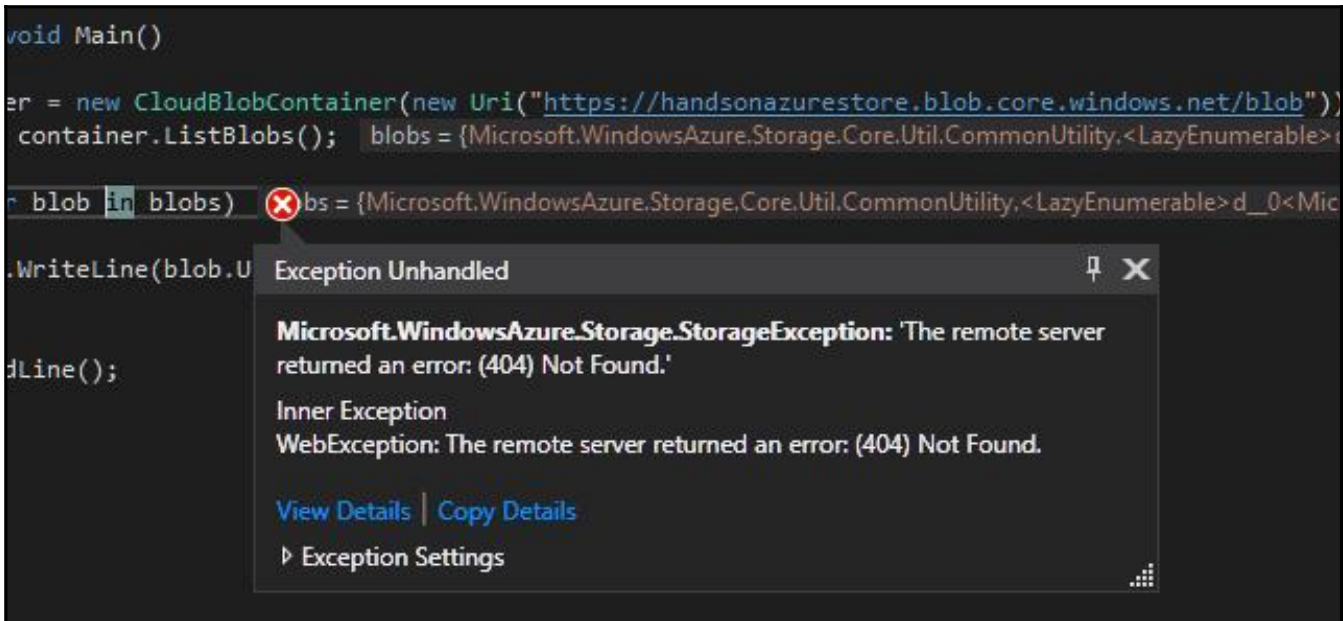
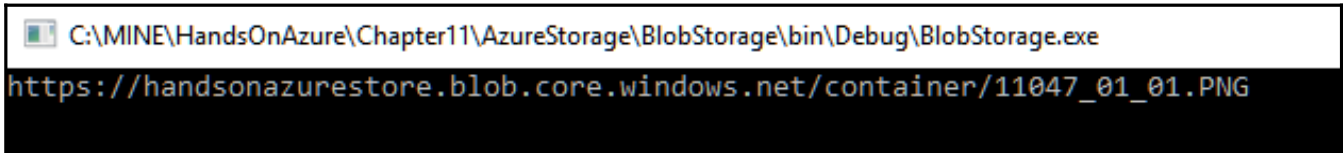
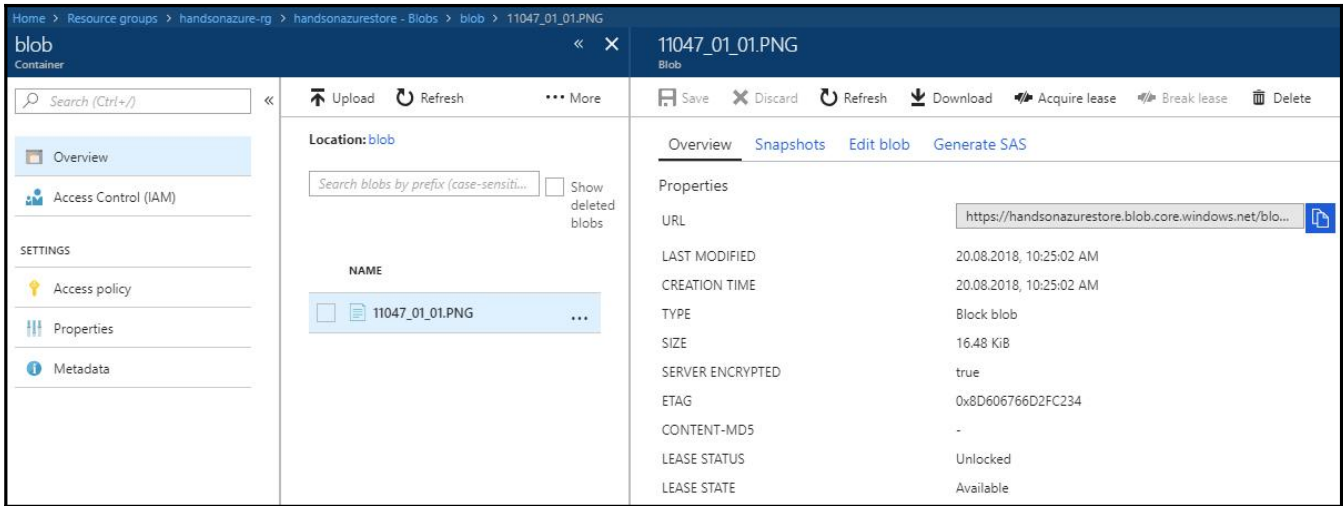

Microsoft Azure

Home > Resource groups > handsonazure-rg > handsonazurestore - Soft delete

handsonazurestore - Soft delete

Storage account

Search (Ctrl+/)

BLOB SERVICE

- Blobs
- Custom domain
- Soft delete**
- Azure CDN

Save Discard

When turned on, soft delete enables you to save and

Soft delete

Disabled Enabled

Retention policies

Retain for 7 days

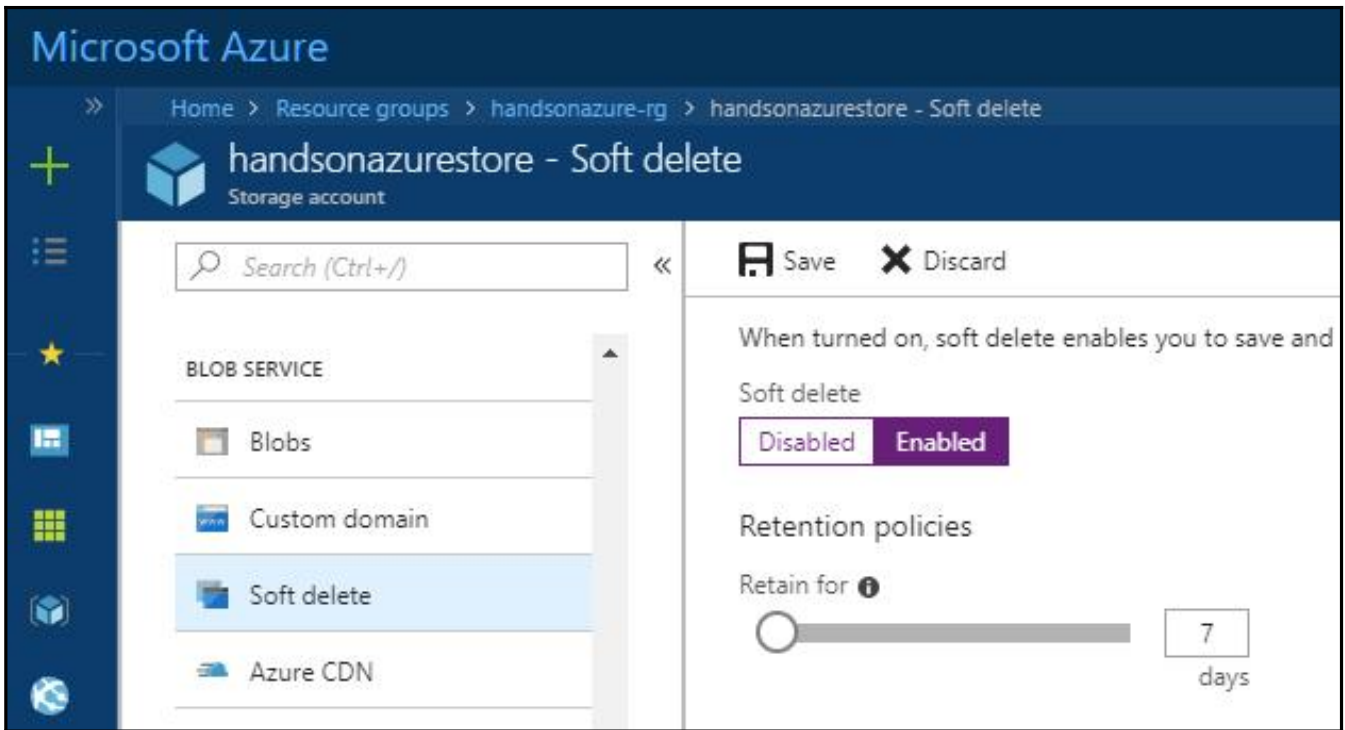

Chapter 12: Big Data Pipeline - Azure Event Hub

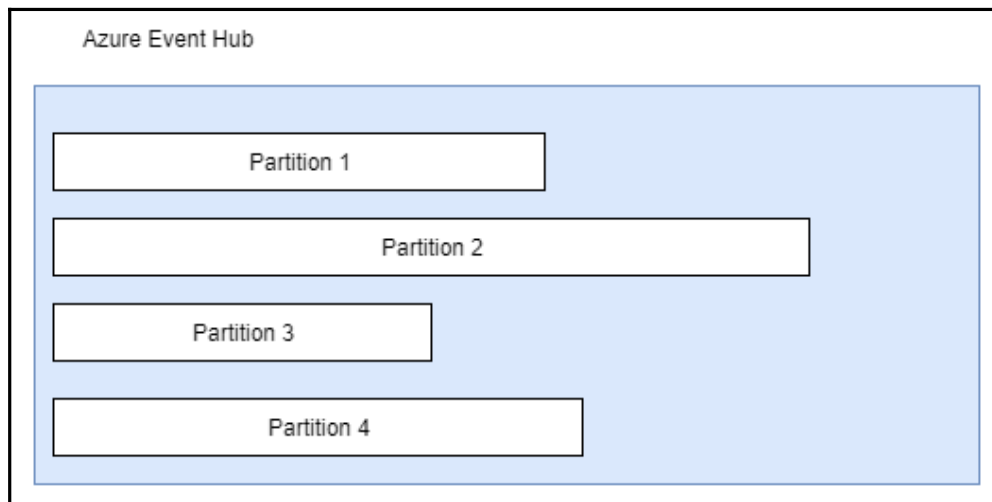
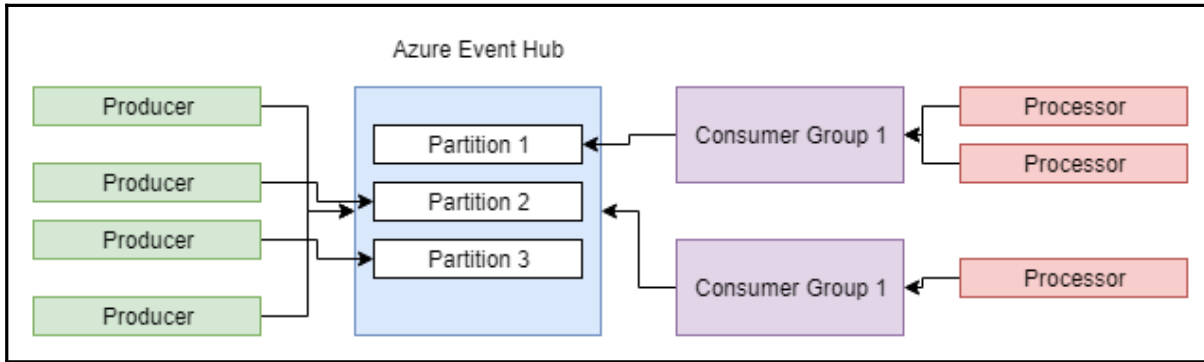

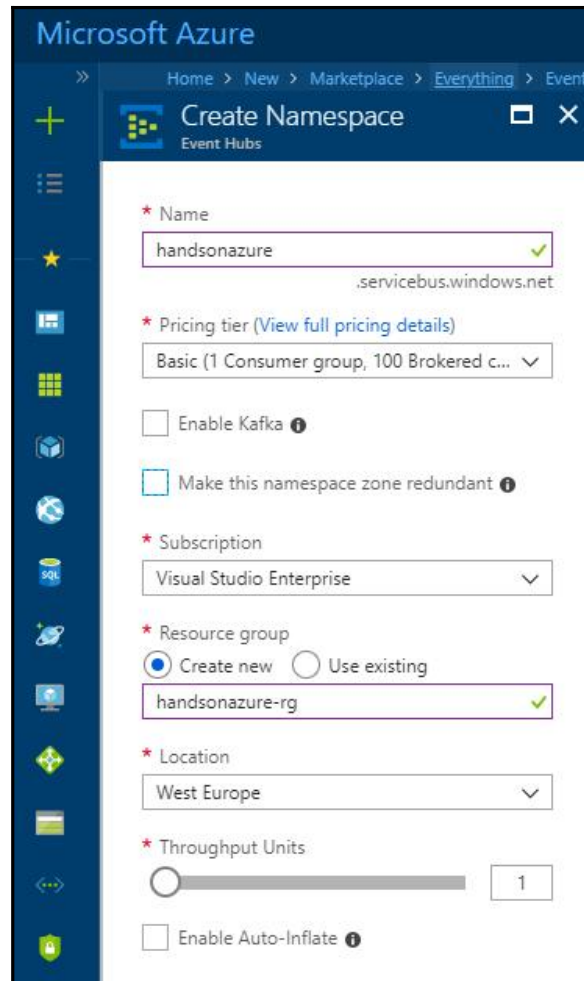

Microsoft Azure

Search resources, services, and docs

Home > Resource groups > handsonazure-rg > handsonazure

handsonazure
Event Hubs Namespace

Search (Ctrl+*/*)

Overview
Access control (IAM)
Tags
Diagnose and solve problems
Events

SETTINGS

Shared access policies
Scale
Geo-Recovery
Locks
Automation script

ENTITIES

Event Hubs

MONITORING

Diagnostics settings
Metrics (preview)

+ Event Hub Delete

| | | |
|--|--|--|
| Resource group (change) handsonazure-rg | Status Active | Location West Europe |
| Subscription (change) Visual Studio Enterprise | Subscription ID | Provisioning state Succeeded |
| Created czwartek, 23 sierpnia 2018, 10:27:02 CEST | Updated czwartek, 23 sierpnia 2018, 10:27:26 CEST | Connection Strings Connection Strings |

Tags (change)
[Click here to add tags](#)

NAMESPACE CONTENTS
0 EVENT HUBS

PRICING TIER
BASIC

Show metrics data for the last:

| | |
|--------|---------|
| 1 hour | 6 hours |
| 7 days | 30 days |

Requests Messages Throughput

100B
90B
80B
70B
60B
50B
40B
30B
20B
10B
0B

17 sie 19 sie 21 sie

INCOMING BYTES. (...)
HANDSONAZURE
0B

OUTGOING BYTES. (...)
HANDSONAZURE
0B

CAPTURED BYTES. (...)
HANDSONAZURE
0B

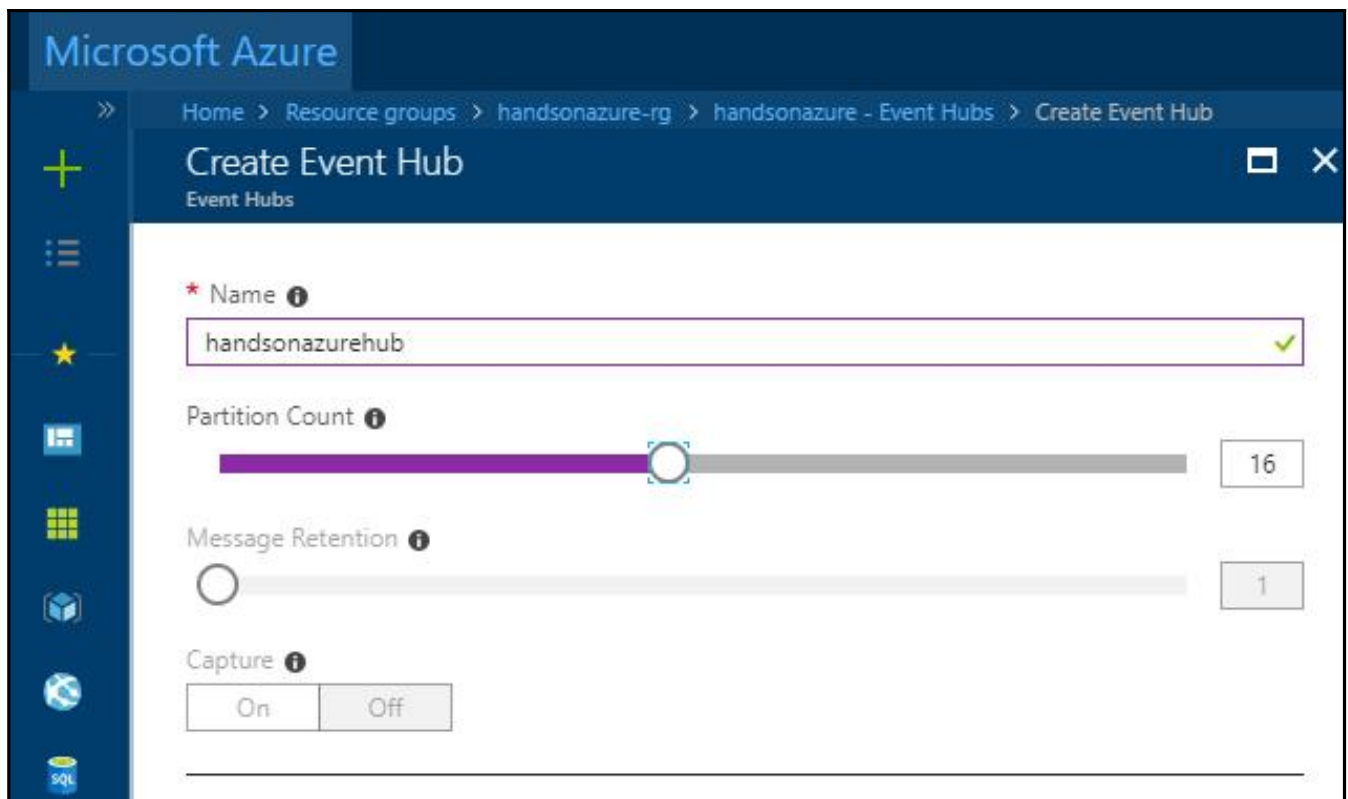
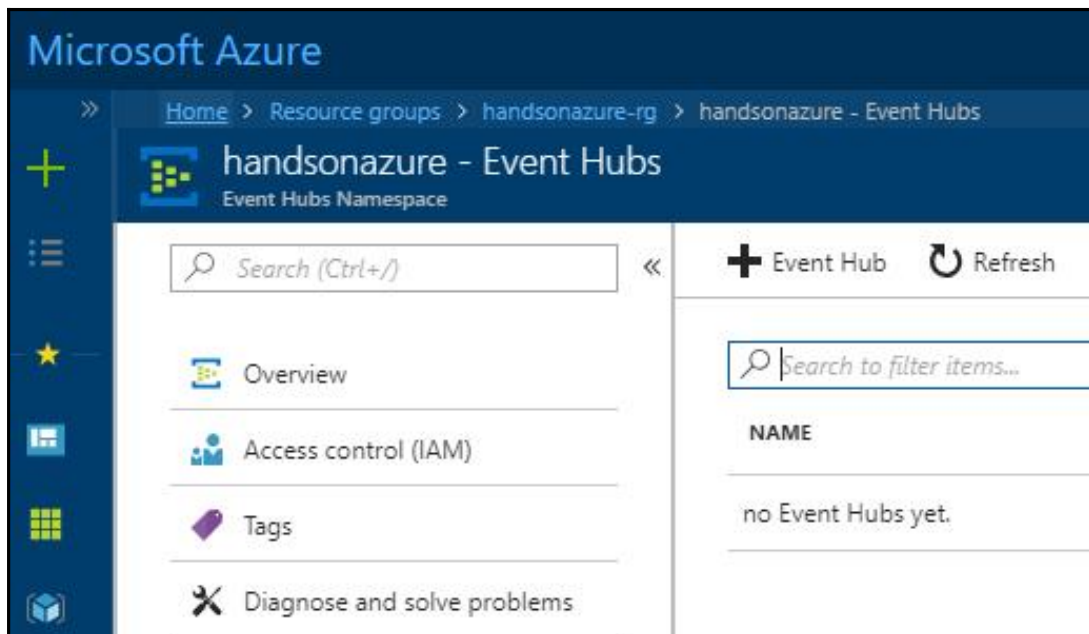

Microsoft Azure

Search resources, services, and docs

Home > Resource groups > handsonazure-rg > handsonazure - Event Hubs > handsonazurehub

handsonazurehub
Event Hubs Instance

Search (Ctrl+J)

Overview
Access control (IAM)
Diagnose and solve problems

SETTINGS
Shared access policies
Properties
Locks
Automation script

ENTITIES
Consumer groups

FEATURES
Capture

SUPPORT + TROUBLESHOOTING
New support request

+ Consumer group Delete

Resource group (change)
handsonazure-rg

Status
Active

Location
West Europe

Subscription (change)
Visual Studio Enterprise

Subscription ID

Namespace
handsonazure

Created
czwartek, 23 sierpnia 2018

Updated
czwartek, 23 sierpnia 2018

EVENT HUB CONTENTS
1 CONSUMER GROUP

EVENT HUB STATUS
ACTIVE

Show metrics data for the last:

1 hour 6 hours 12 hours 1 day
7 days 30 days

Requests

Messages

Throughput

INCOMING REQUESTS... HANDSONAZURE
SUCCESSFUL REQUES... HANDSONAZURE
0

INCOMING MESSAGES... HANDSONAZURE
OUTGOING MESSAGES... HANDSONAZURE

INCOMING BYTES (... HANDSONAZURE
OUTGOING BYTES (... HANDSONAZURE



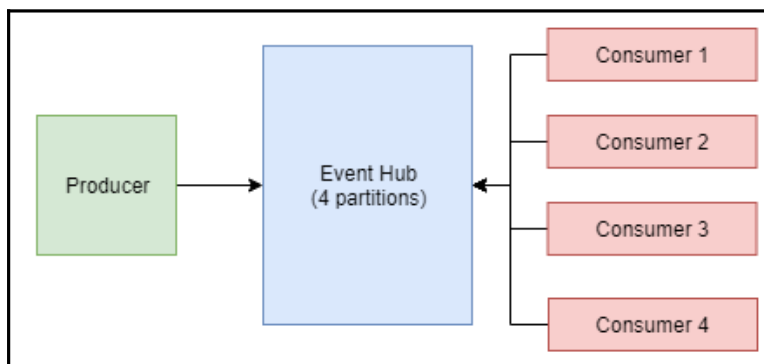

Search to filter items...

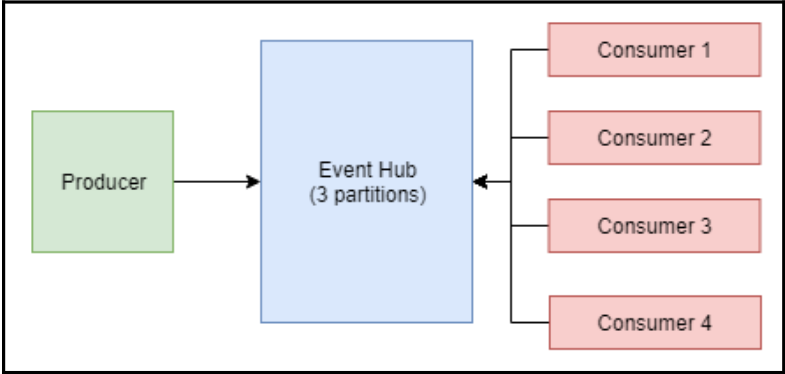
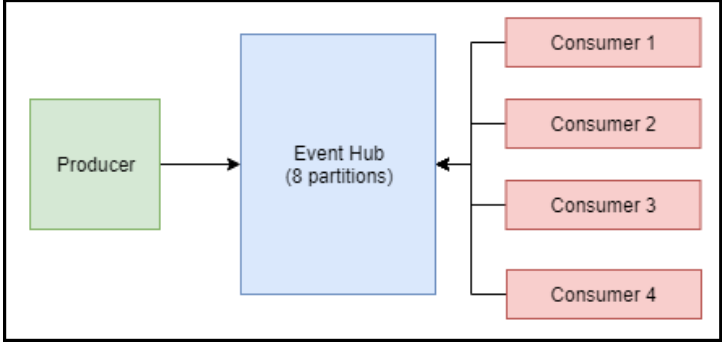
| NAME | LOCATION |
|-----------|-------------|
| \$Default | West Europe |





SAS Policy: handsonazure send ✕

 Save  Discard  Delete  More

Manage

Send

Listen

Primary key
 

Secondary key
 

Connection string—primary key
 

Connection string—secondary key
 

SAS Policy: handsonazurereceive

Save Discard Delete More

Manage

Send

Listen

Primary key

Secondary key

Connection string-primary key

Connection string-secondary key

Home > Resource groups > handsonazure-rg > handsonazure - Virtual networks and IP filters

handsonazure - Virtual networks and IP filters

Event Hubs Namespace

Search (Ctrl+/)

Refresh

Configure network security for your Event Hub using [Virtual Networks](#) and/or [IP Filters](#).

Virtual Networks (preview)
 Configure your Event Hub Namespace to only accept connections from specific Virtual Networks. [+ Add existing virtual](#)

| NAME | VIRTUAL NETWORK | SUBNET |
|--|-----------------|--------|
| No Virtual Network rules have been set yet | | |

IP Filters (preview)
 Configure your Event Hub Namespace to accept or reject connections from certain IP addresses. [+ Add IP Filter Rule](#)

| NAME | IP (SINGLE IPV4 OR CIDR RANGE) |
|--------------------------------------|--------------------------------|
| No IP Filter rules have been set yet | |

- Overview
- Access control (IAM)
- Tags
- Diagnose and solve problems
- Events
- Settings
 - Shared access policies
 - Scale
 - Geo-Recovery
 - Virtual networks and IP filters**
 - Locks

Add IP Filter Rule ✕

handsonazure

Rules are evaluated in the order that they are created. Ensure that you create any **Accept** rules before any **Reject** rules. If you wish to change the order of your rules, you will need to delete and re-create them accordingly.

* IP Filter Name ⓘ

Rule ✓

* IP Range ⓘ

83.28.251.26 ✓

* Action ⓘ

Reject ▼

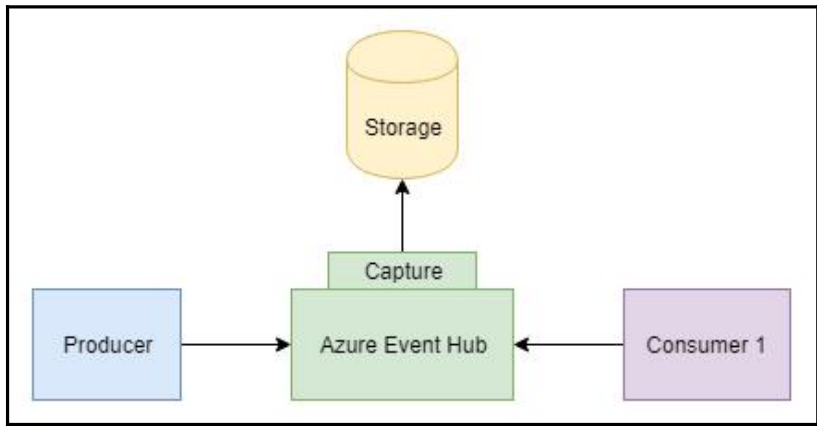
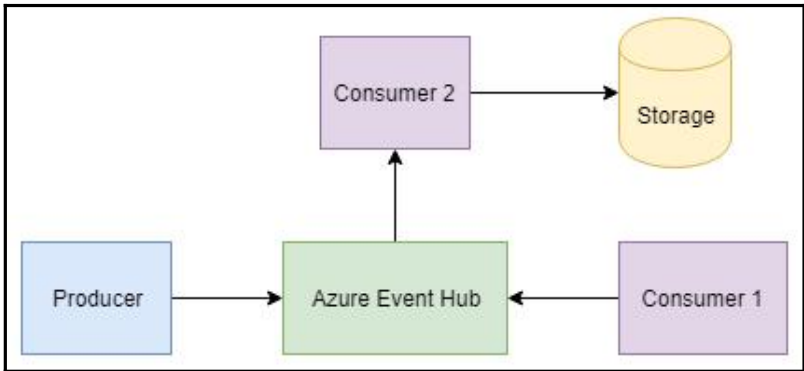

Save changes Discard



Azure Event Hubs Capture enables you to automatically deliver the streaming data in Event Hubs to an Azure Blob storage or Azure Data Lake Store account of your choice, with the added flexibility of specifying a time or size interval. Setting up Capture is fast, there are no administrative costs to run it, and it scales automatically with Event Hubs throughput units. Event Hubs Capture is the easiest way to load streaming data into Azure, and enables you to focus on data processing rather than on data capture. Learn more about capture [here](#).

Capture

On Off

Note: Enabling Capture will result in additional charges to this account. Learn more about our pricing [here](#).

Time window (minutes)

5

Size window (MB)

300

Capture Provider

Azure Storage

* Azure Storage Container

handsonazurehub

Select Container

Storage Account

/subscriptions/94f33c43-60b5-4042-ae74-51777f69f99a/resourceGroups/handsonazure-rg/providers/Microsoft.Storage/storageAccounts/handsonazurestorage

Sample Capture file name formats

{Namespace}/{EventHub}/{PartitionId}/{Year}/{Month}/{Day}/{Hour}/{Minute}/{Second}

Capture file name format ⓘ

{Namespace}/{EventHub}/{PartitionId}/{Year}/{Month}/{Day}/{Hour}/{Minute}/{Second}

e.g. handsonazure/handsonazurehub/0/2018/7/27/8/45/46

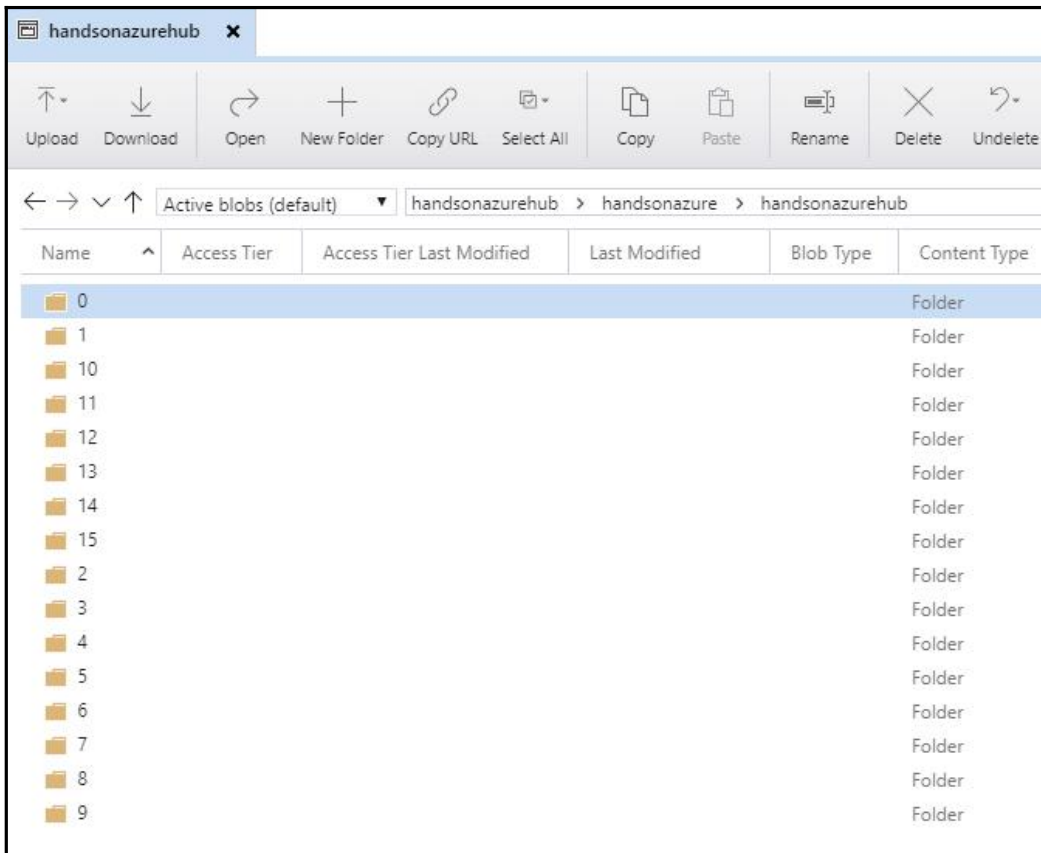

Chapter 13: Real-Time Data Analysis - Azure Stream Analytics

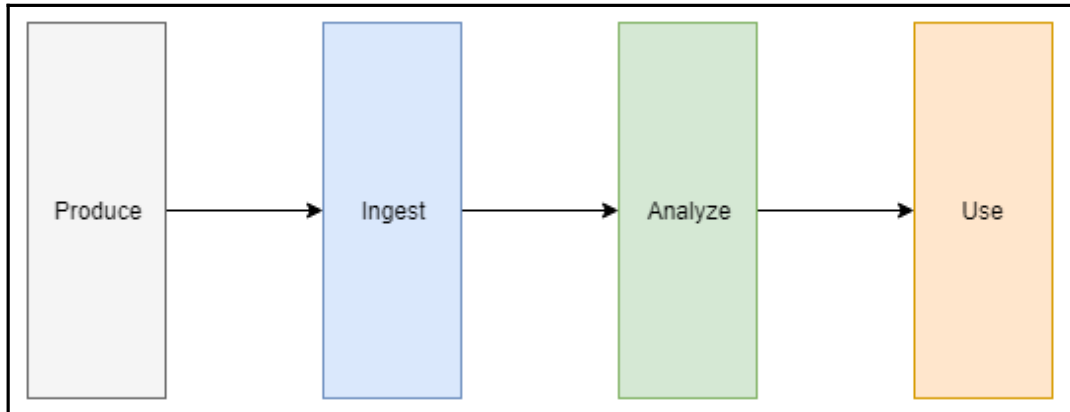

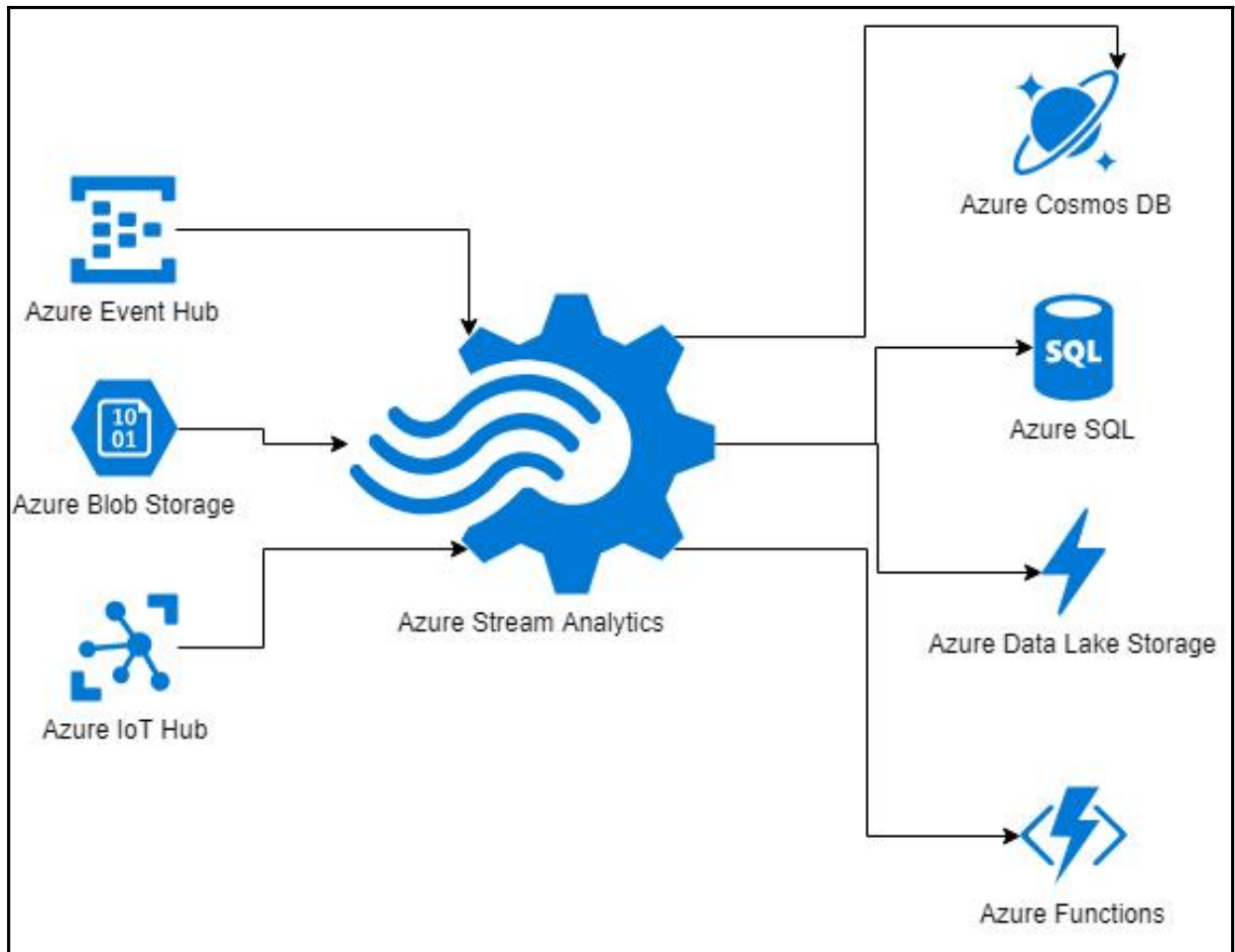

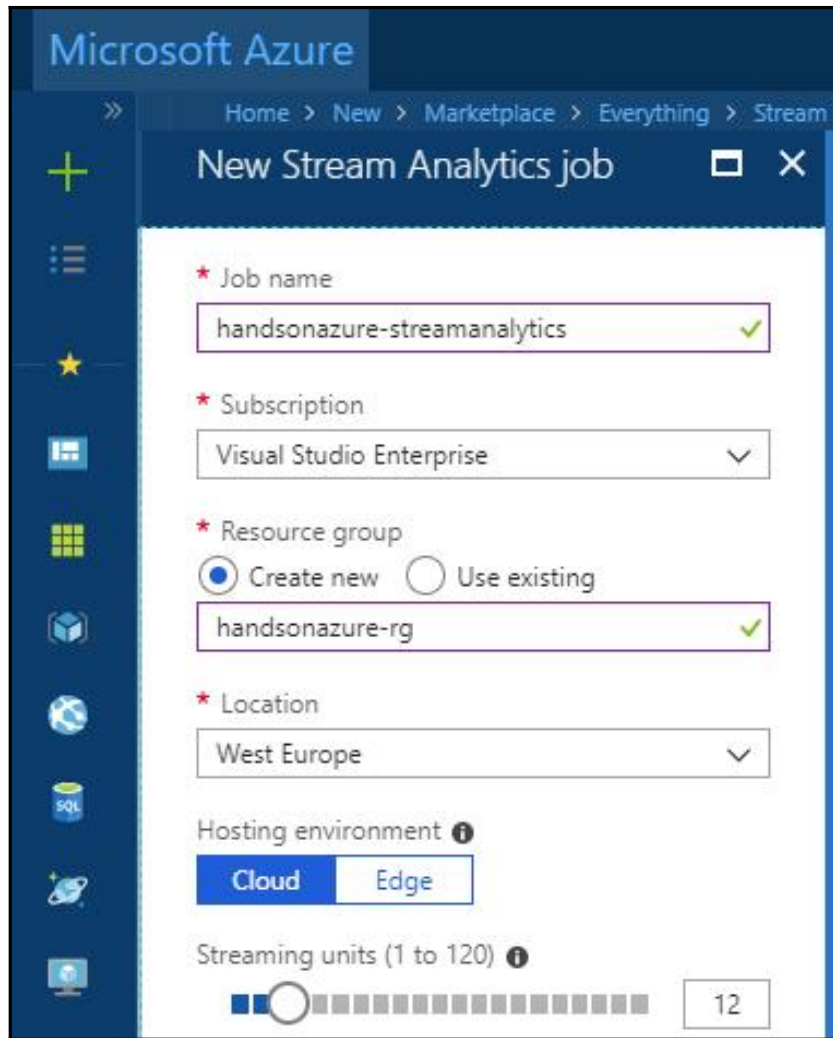

Microsoft Azure

Home > handsonazure-streamanalytics

handsonazure-streamanalytics

Stream Analytics job

Search (Ctrl+/)

- Overview
- Activity log
- Access control (IAM)
- Tags
- Diagnose and solve problems

SETTINGS

- Locks

JOB TOPOLOGY

- Inputs
- Functions
- Query
- Outputs

Start Stop Delete

Created

Resource group (change)
handsonazure-rg

Status
Created

Location
West Europe

Subscription (change)
Visual Studio Enterprise

Subscription ID
[REDACTED]

Send feedback
UserVoice

Created
czwartek, 30 sierpnia 2018,

Started
-

Last output
-

Hosting environment
Cloud

Inputs
0 [Add] Empty

Outputs
0 [Add] Empty

Query

```

1 SELECT
2   *
3 INTO
4   [YourOutputAlias]
5 FROM
6   [YourInputAlias]

```

JOB TOPOLOGY

- [Add] Inputs
- [Add] Functions
- <> Query
- [Add] Outputs

Event Hub ✕

New input

* Input alias ⋮ ✓

Provide Event Hub settings manually
 Select Event Hub from your subscriptions

Subscription ▼

* Event Hub namespace ⓘ ▼

* Event Hub name ⓘ
 Create new Use existing

✓

* Event Hub policy name ⓘ ▼

Event Hub policy key ⋮

Event Hub consumer group ⓘ

* Event serialization format ⓘ ▼

Encoding ⓘ ▼

Event compression type ⓘ ▼

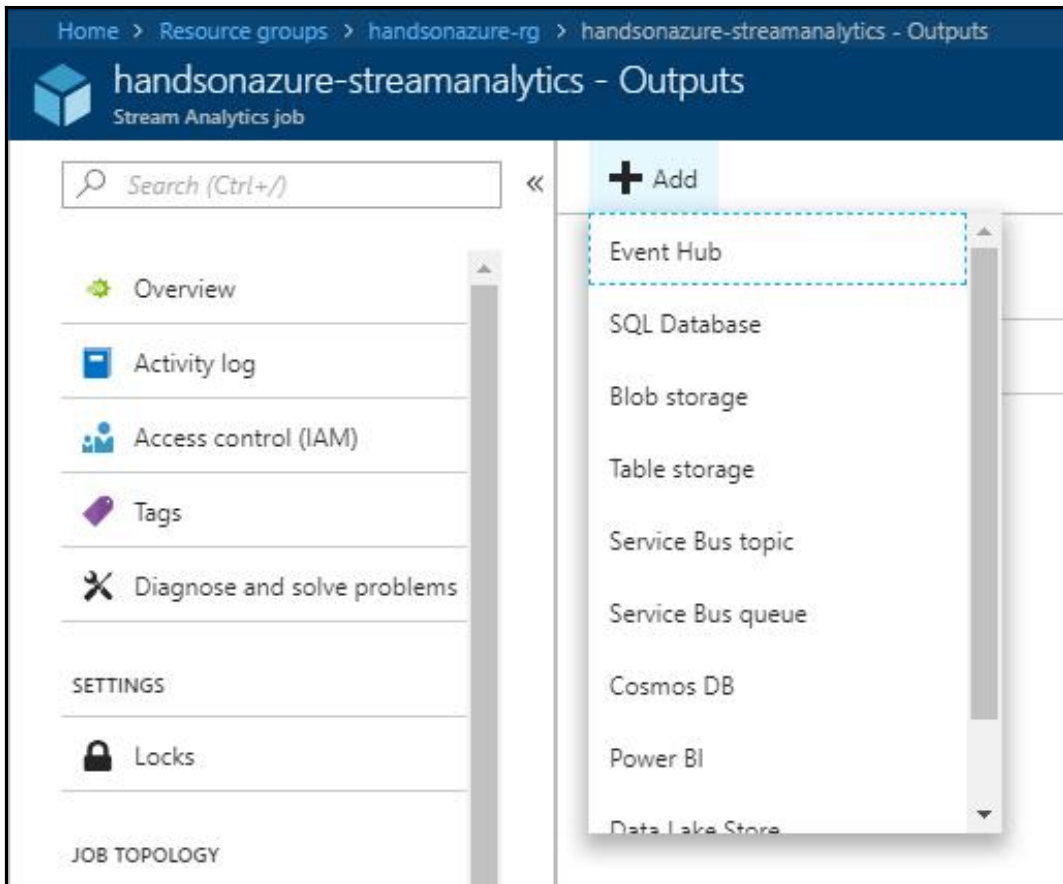

Table storage

New output

* Output alias

handsonazure-tablestorage ✓

Provide table storage settings manually

Select table storage from your subscriptions

Subscription

Visual Studio Enterprise

Storage account ⓘ

handsonazurestorage

* Storage account key

.....

* Table name ⓘ

Create new Use existing

streamanalytics ✓

* Partition key ⓘ

{Id} ✓

* Row key ⓘ

{Date} ✓

Batch size ⓘ

100

Inputs

1

handsonazure-alias

Outputs

1

handsonazure-tablestorage

Query

```

1 SELECT
2     EventProcessedUtcTime AS Date,
3     EventEnqueuedUtcTime,
4     PartitionId AS Id
5 INTO
6     [handsonazure-tablestorage]
7 FROM
8     [handsonazure-alias]
```

Home > Resource groups > handsonazure-rg > handsonazure-streamanalytics - Query

handsonazure-streamanalytics - Query

Stream Analytics job

Search (Ctrl+/)

- Inputs
- Functions
- Query**
- Outputs

CONFIGURE

Scale

Save Discard Test

- Inputs (1)
 - handsonazure-alias
- Outputs (1)
 - handsonazure-tablestorage

Need help with your query? Check out some of the most common

```

1 SELECT
2     EventProcessedUtcTime AS Date,
3     EventEnqueuedUtcTime,
4     PartitionId AS Id
5 INTO
6     [handsonazure-tablestorage]
7 FROM
8     [handsonazure-alias]
```

streamanalytics x

| PartitionKey | RowKey | Timestamp | date | eventenqueuedutctime | id | id |
|--------------|------------------------------|--------------------------|--------------------------|--------------------------|----|----|
| 0 | 2018-09-02T10:11:01.5833957Z | 2018-09-02T10:11:03.707Z | 2018-09-02T10:11:01.583Z | 2018-09-02T10:09:36.064Z | 0 | 0 |
| 0 | 2018-09-02T10:11:01.9123678Z | 2018-09-02T10:11:03.964Z | 2018-09-02T10:11:01.912Z | 2018-09-02T10:11:00.836Z | 0 | 0 |
| 0 | 2018-09-02T10:11:06.6146845Z | 2018-09-02T10:11:08.380Z | 2018-09-02T10:11:06.614Z | 2018-09-02T10:11:06.495Z | 0 | 0 |
| 0 | 2018-09-02T10:11:09.3648344Z | 2018-09-02T10:11:11.110Z | 2018-09-02T10:11:09.364Z | 2018-09-02T10:11:09.278Z | 0 | 0 |
| 0 | 2018-09-02T10:11:12.1930872Z | 2018-09-02T10:11:13.801Z | 2018-09-02T10:11:12.193Z | 2018-09-02T10:11:12.106Z | 0 | 0 |
| 0 | 2018-09-02T10:11:15.0110131Z | 2018-09-02T10:11:16.759Z | 2018-09-02T10:11:15.011Z | 2018-09-02T10:11:14.887Z | 0 | 0 |
| 0 | 2018-09-02T10:11:18.7952400Z | 2018-09-02T10:11:20.110Z | 2018-09-02T10:11:18.795Z | 2018-09-02T10:11:17.780Z | 0 | 0 |

| PartitionKey | RowKey | Timestamp | date | id |
|--------------|--------------------------------------|--------------------------|--------------------------|--------------------------------------|
| 0 | 06b9096c-deb1-4bf1-a485-6d05cb4ee347 | 2018-09-02T10:29:25.162Z | 2018-09-02T10:29:03.131Z | 06b9096c-deb1-4bf1-a485-6d05cb4ee347 |
| 0 | 19a5cac4-a08c-4c5b-997a-b1912df6c774 | 2018-09-02T10:29:25.154Z | 2018-09-02T10:28:01.163Z | 19a5cac4-a08c-4c5b-997a-b1912df6c774 |
| 0 | 1f555ecf-2965-4d7d-854b-8019e624c6f4 | 2018-09-02T10:29:25.150Z | 2018-09-02T10:27:24.631Z | 1f555ecf-2965-4d7d-854b-8019e624c6f4 |
| 0 | 25c43459-ced9-4600-89d4-945a7b4252d5 | 2018-09-02T10:29:31.638Z | 2018-09-02T10:29:34.098Z | 25c43459-ced9-4600-89d4-945a7b4252d5 |
| 0 | 2c9a7713-a035-4504-8c58-deb9edc25db1 | 2018-09-02T10:29:25.159Z | 2018-09-02T10:28:43.376Z | 2c9a7713-a035-4504-8c58-deb9edc25db1 |
| 0 | 2dc60433-7fa5-4aab-8c1b-b8757a8fed07 | 2018-09-02T10:29:25.164Z | 2018-09-02T10:29:20.004Z | 2dc60433-7fa5-4aab-8c1b-b8757a8fed07 |

Home > Resource groups > handsonazure-rg > handsonazure-streamanalytics - Event ordering

handsonazure-streamanalytics - Event ordering

Stream Analytics job

Search (Ctrl+ /) Save Discard

- Functions
- Query
- Outputs

CONFIGURE

- Scale
- Locale
- Event ordering**
- Error policy
- Compatibility level

Events that arrive late
Accept late events with a timestamp in the following range: ⓘ

Days: 00 Hours: 00 Minutes: 00 Seconds: 05

Out of order events
Accept out of order events with a timestamp in the following range: ⓘ

Minutes: 00 Seconds: 00

Handling other events
Action ⓘ

Adjust Drop

Chapter 14: Enterprise Integration - Azure Service Bus

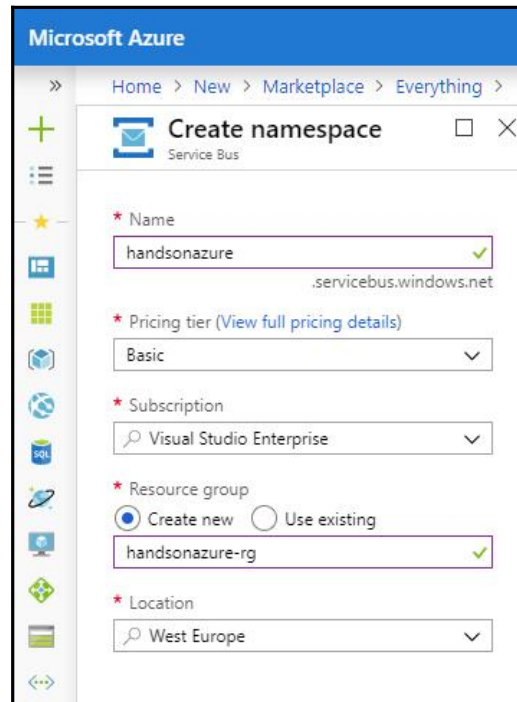

Microsoft Azure Search resources, services, and docs

Home > Resource groups > handsonazure-rg > handsonazure

handsonazure
Service Bus Namespace

Search (Ctrl+/)

- Overview
- Activity log
- Access control (IAM)
- Tags
- Diagnose and solve problems

Settings

- Shared access policies
- Scale
- Geo-Recovery
- Properties
- Locks

[+ Queue](#)
[+ Topic](#)
[X Convert](#)
[Refresh](#)
[Delete](#)

| | | |
|--|------------------|-------------------------|
| Resource group (change) handsonazure-rg | Status Active | Location West Europe |
|--|------------------|-------------------------|

Tags (change)
[Click here to add tags](#)

Show data for the last:
 1 hour
6 hours
12 hours
1 day
7 days
30 days
[Click for additional metrics](#)

Requests

Create queue ✕

Service Bus

*** Name** ⓘ

myfirstqueue ✓

Max queue size

1 GB ▾

Message time to live ⓘ

| Days | Hours | Minutes | Seconds |
|------|-------|---------|---------|
| 14 | 0 | 0 | 0 |

Lock duration ⓘ

| Days | Hours | Minutes | Seconds |
|------|-------|---------|---------|
| 0 | 0 | 0 | 30 |

Enable duplicate detection ⓘ

Duplicate detection window ⓘ

| Days | Hours | Minutes | Seconds |
|------|-------|---------|---------|
| 0 | 0 | 0 | 30 |

Enable dead lettering on message expiration ⓘ

Enable sessions ⓘ

Enable partitioning ⓘ

Home > Resource groups > handsonazure-rg > handsonazure > myfirstqueue

myfirstqueue
Service Bus Queue

Search (Ctrl+/)

Overview

Diagnose and solve problems

Settings

- Shared access policies
- Metrics (preview)
- Properties
- Locks
- Automation script

Support + troubleshooting

- New support request

Delete

Essentials ^

Namespace
handsonazure

| | | | |
|------------------------------------|------------|--|--------|
| Active message count | 0 MESSAGES | Max size | 16 GB |
| Scheduled message count | 0 MESSAGES | CURRENT | 0.0 KB |
| Dead-letter message count | 0 MESSAGES |  | |
| Transfer message count | 0 MESSAGES | | |
| Transfer dead-letter message count | 0 MESSAGES | | |

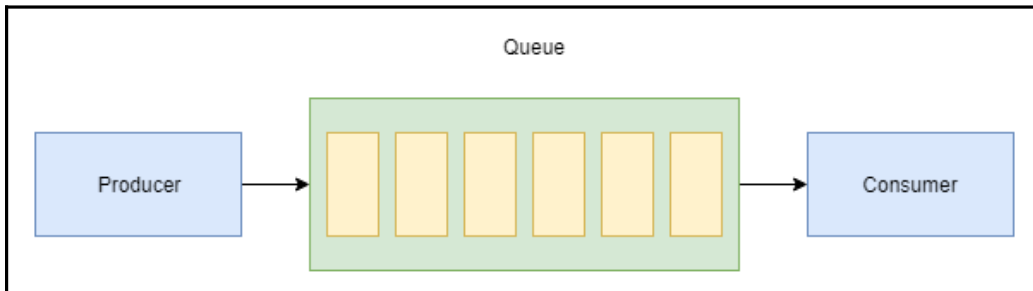

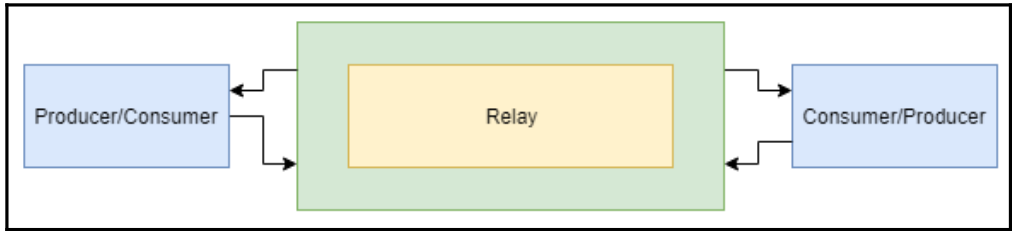
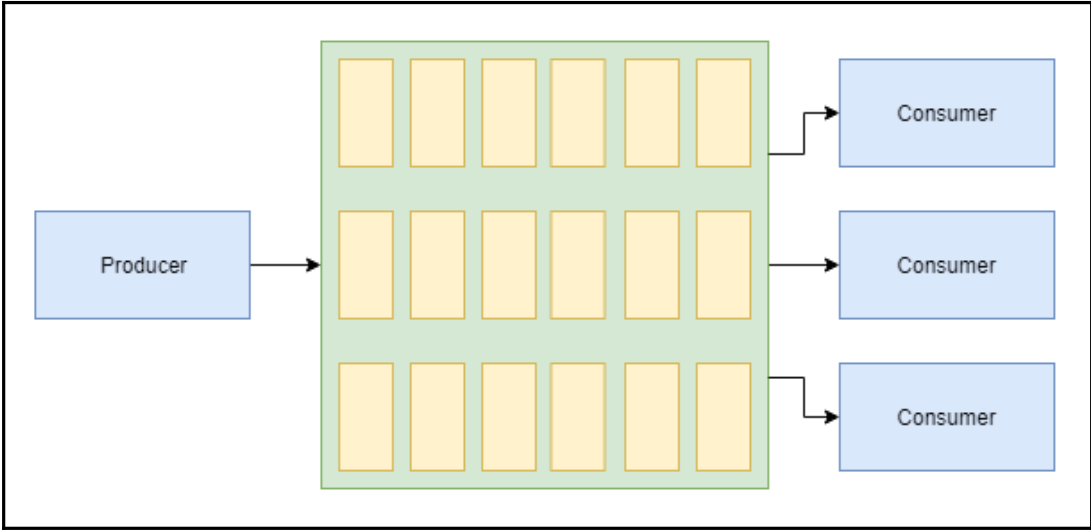

Home > Resource groups > handsonazure-rg > handsonazure > myfirstqueue

myfirstqueue

Service Bus Queue

Search (Ctrl+/)

- Overview
- Diagnose and solve problems
- Settings
 - Shared access policies
 - Metrics (preview)
 - Properties
 - Locks
 - Automation script
- Support + troubleshooting
 - New support request

Delete

Essentials

Namespace
handsonazure

| | | | |
|------------------------------------|------------|--|--------|
| Active message count | 3 MESSAGES | Max size | 16 GB |
| Scheduled message count | 0 MESSAGES | CURRENT | 0.5 KB |
| Dead-letter message count | 0 MESSAGES |  | |
| Transfer message count | 0 MESSAGES | | |
| Transfer dead-letter message count | 0 MESSAGES | | |

Add permissions

Role ?

Contributor

Assign access to ?

Azure AD user, group, or application

Select ?

some_serivce !

myfirstqueue

Service Bus Queue

- Overview
- Diagnose and solve problems

Settings

- Shared access policies
 - Metrics (preview)
 - Properties
 - Locks
 - Automation script
- Support + troubleshooting
- New support request

Delete

Essentials ^

Namespace
handsonazure

Active message count
0 MESSAGES

Scheduled message count
0 MESSAGES

Dead-letter message count
9 MESSAGES

Transfer message count
0 MESSAGES

Transfer dead-letter message count
0 MESSAGES

Max size
16 GB

CURRENT
1.6 KB



Chapter 15: Using Application Insights to Monitor Your Applications

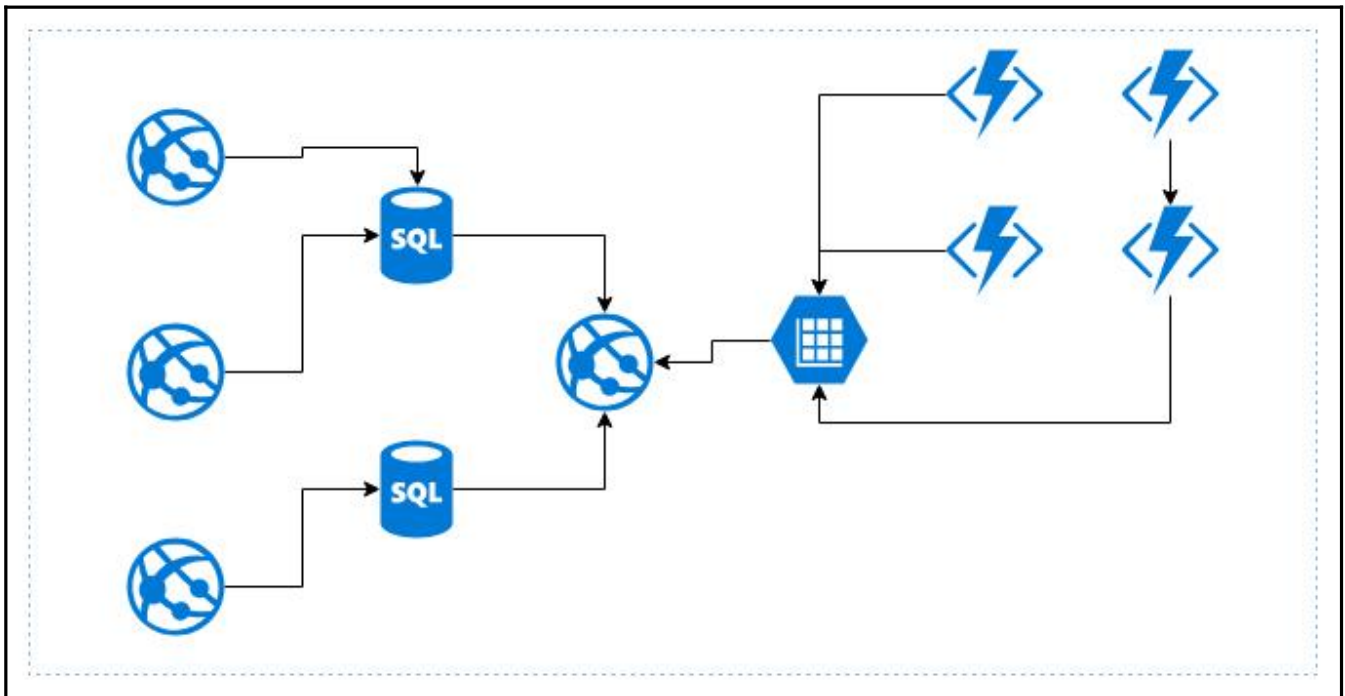

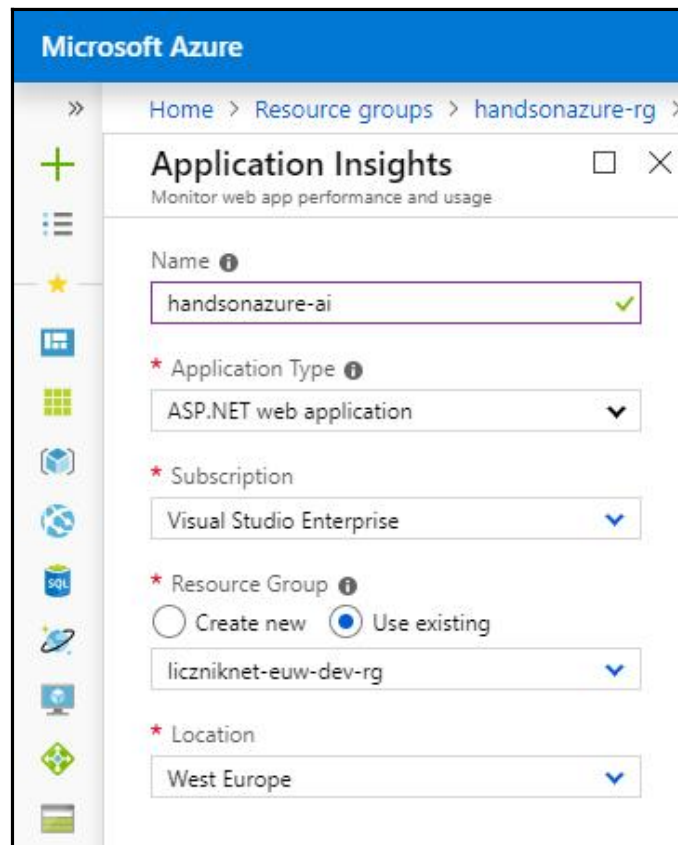
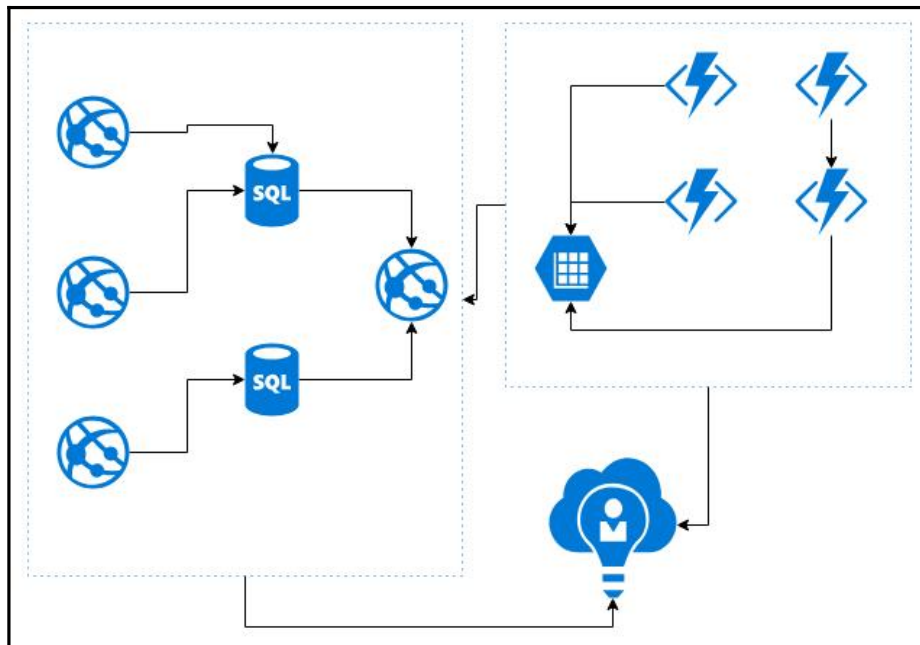

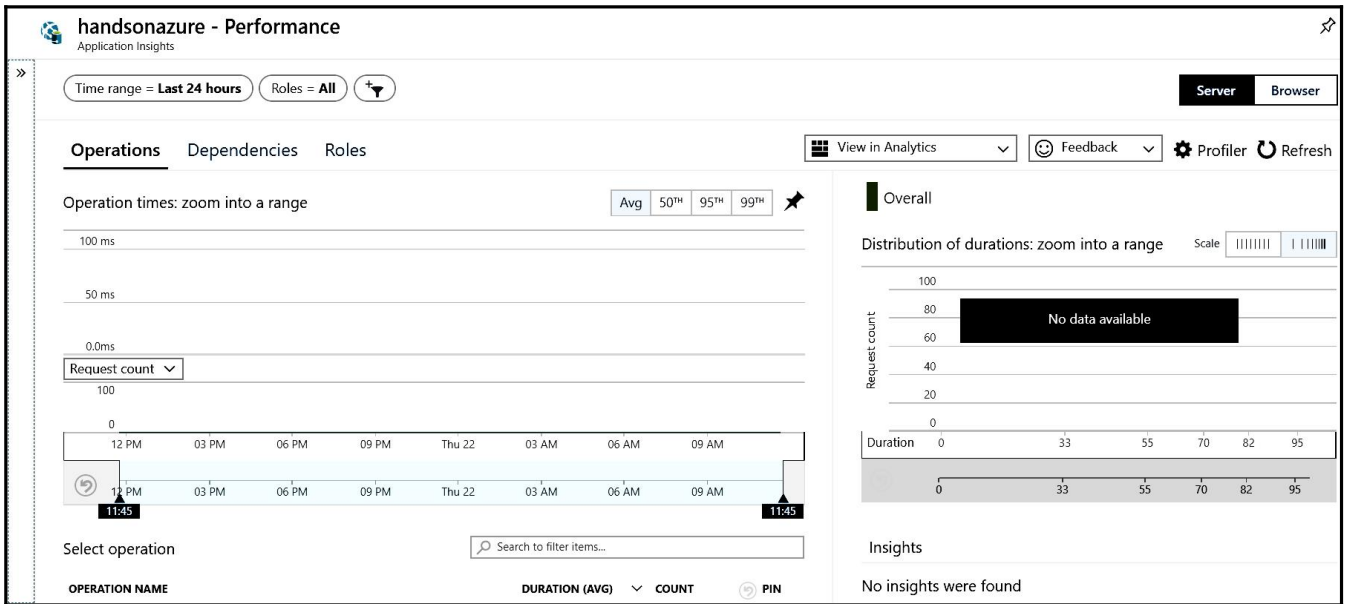
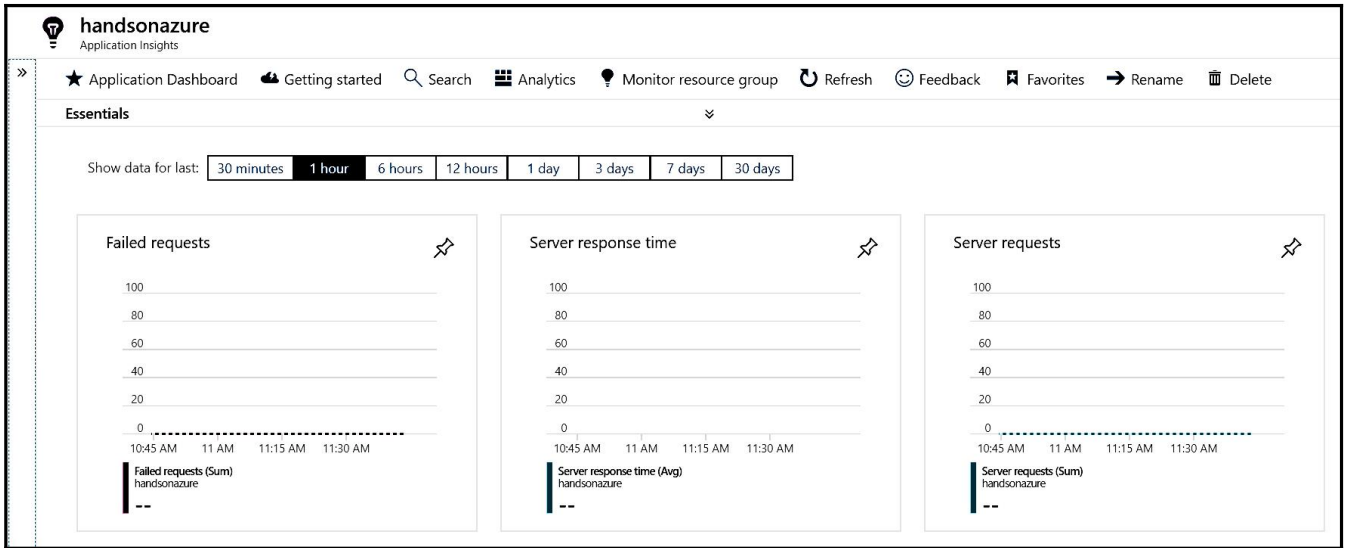

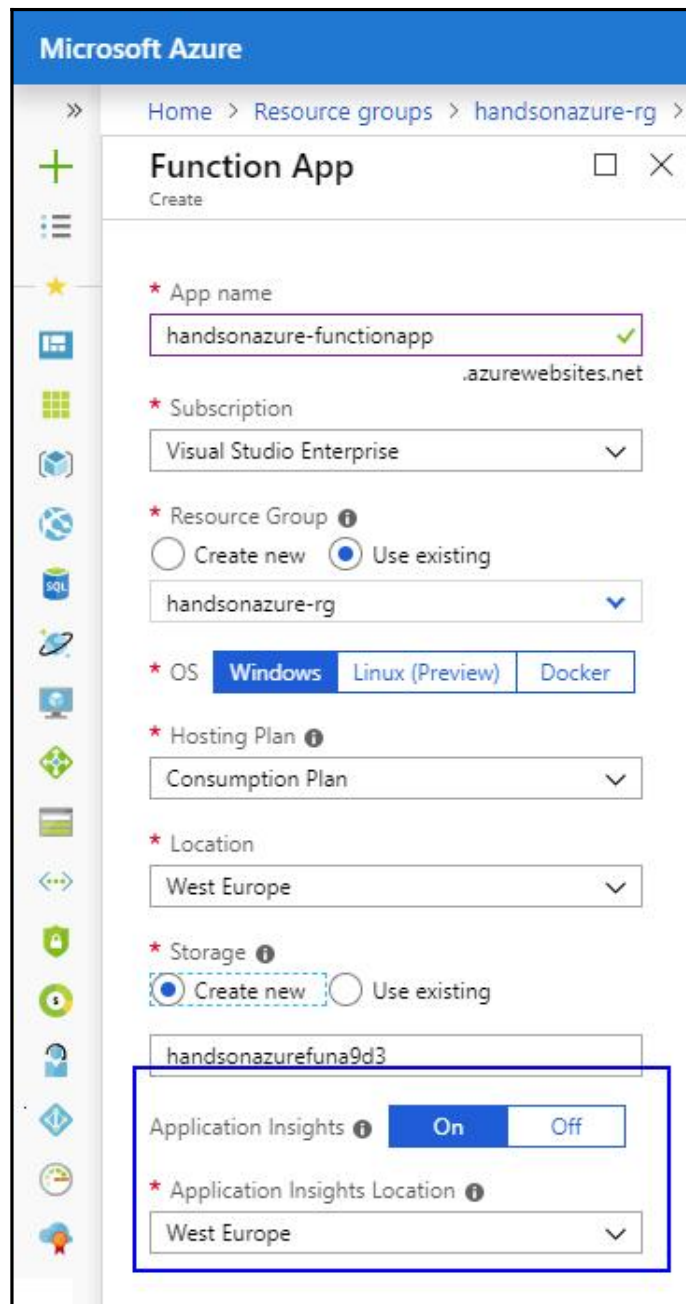

>> + Create work item

 **handsonazure-functionapp**
HttpTriggerJS1

Request Properties [Show all](#)

| | | |
|--------------------|---|-----|
| Event time | 14.09.2018, 12:31:35 | ... |
| Request name | HttpTriggerJS1 | ... |
| Response code | 200 | ... |
| Successful request | True | ... |
| Response time | 1.5 s | ... |
| Request URL | https://handsonazure-functionapp.azurewebsites.net/api/HttpTriggerJS1 | ... |

Custom Data

| | | |
|------------------|--|-----|
| {OriginalFormat} | Executed '{FullName}' (Succeeded, Id={InvocationId}) | ... |
| TriggerReason | This function was programmatically called via the host APIs. | ... |
| Succeeded | True | ... |
| HttpMethod | POST | ... |
| FullName | Functions.HttpTriggerJS1 | ... |
| LogLevel | Information | ... |
| Category | Host.Results | ... |
| EndTime | 2018-09-14T10:31:36.5270000Z | ... |

 Getting started
  Search
  Analytics
  Refresh
  Feedback
  Favorites

Logs

handsonazure-ai

New Query 1



handsonazure-ai



Run

Time range: Last 24 hours

Schema

Filter (preview)



Type your query here...

Filter by name or type...



Collapse all

ACTIVE

handsonazure-ai



APPLICATION INSIGHTS

- traces
- customEvents
- pageViews
- requests
- dependencies
- exceptions
- availabilityResults
- customMetrics

Select queries

Performance

Browser

Failures

Response time: average request duration over the last 12 hours

requests | where timestamp > ago(12h) | summarize avgRequestDuration=

Run

Time range: Last 7 days

requests

```
summarize RequestsCount=sum(itemCount), AverageDuration=avg(duration), percentiles(duration, 50, 95, 99) by operation_Name
order by RequestsCount desc
```

Completed. Showing results from the last 7 days.

TABLE CHART Columns

Drag a column header and drop it here to group by that column

| operation_Name | RequestsCount | AverageDuration | percentile_duration_50 | percentile_duration_95 | percentile_duration_99 |
|------------------|---------------|-----------------|------------------------|------------------------|------------------------|
| > | 2 | 309 | 309 | 309 | 309 |
| > HttpTriggerJS1 | 1 | 1,509.9869 | 1,509.9869 | 1,509.9869 | 1,509.9869 |

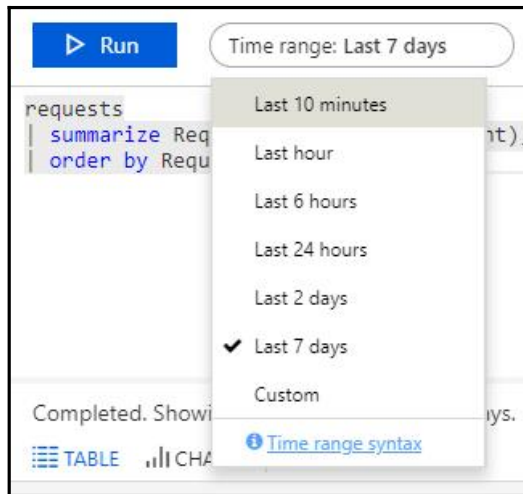

New Query 1* +

handsonazure-ai  ▶ Run

Schema **Filter (preview)** <<



Filter by name... 

i Showing top 10 values for each facet

- ▼ **name** (2)
 - GET /customers (2)
 - HttpTriggerJS1 (1)
- ▼ **operation_Name** (2)
 - (empty) (1)
 - HttpTriggerJS1 (1)
- ▼ **performanceBucket** (2)
 - 250ms-500ms (2)
 - 1sec-3sec (1)
- ▼ **resultCode** (1)
 - 200 (3)
- ▼ **success** (1)
 - True (3)
- ▼ **url** (2)
 - http://myserver/customers (2)
 - https://handsonazure-functionap... (1)

requests
| summarize
| order by

Completed. Sho

 TABLE 

Drag a column

| | |
|---|---------------|
| | operation_Na |
| > | |
| > | HttpTriggerJS |

- handsonazure-rg
 - providers
 - * Show all
 - + Microsoft.Resources
 - + Microsoft.Storage
 - + Microsoft.Web
 - microsoft.insights
 - * Show all
 - alertrules
 - Failure Anomalies
 - incidents
 - + components
 - resources



- Configure
- ||| Properties
 - !** Alerts
 - 🔍 Smart Detection settings
 - 🕒 Usage and estimated costs
 - 🔄 Continuous export
 - 📊 Performance Testing
 - 🔑 API Access
 - ☰ Work Items

1. Define alert condition

Alert condition configuration requires 1) Target selection and 2) Alert criteria definition where signal(s) and alert logic is configured. Start by selecting a Target.



*** Alert target** Target Hierarchy

handsonazurefun9d3

 Visual Studio Enterprise >
  handsonazure-rg

[+ Select target](#)

*** Alert criteria** Monthly cost in USD (Estimated) ⓘ

| | | | |
|---|--|----------------|---|
|  | Whenever the Ingress is Greater than 1024000 bytes | \$ 0.10 |  |
| Total | | \$ 0.10 | |



[+ Add criteria](#)

2. Define alert details

*** Alert rule name ⓘ**

Critical Ingress 

*** Description**

An alert run when ingress exceeds 1GB 

*** Severity ⓘ**

Sev 2 

Enable rule upon creation

Yes No

 It can take up to 10 minutes for a metric alert rule to become active.

[+ New alert rule](#)
[☰ Edit columns](#)
[👤 Manage action groups](#)
[🔔 View classic alerts](#)
[🔄 Refresh](#)

* Subscription ⓘ
 Resource group ⓘ
 Resource type

[Visual Studio Enterprise](#) > [handsonazure-rg](#)

i You are viewing newer alert rules. If you want to see classic alert rules, click on "View classic alerts"

Displaying 1 - 1 rules out of total 1 rules

🔍 Search alert rules based on rule name and condition...

| NAME | ↑↓ | CONDITION |
|------------------|----|-----------------------------|
| Critical Ingress | | Ingress GreaterThan 1024000 |

Chapter 16: SQL in Azure - Azure SQL

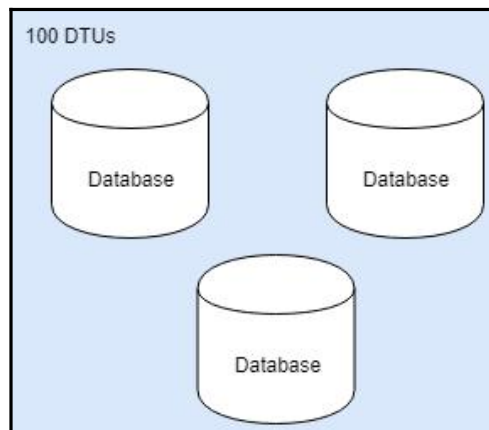
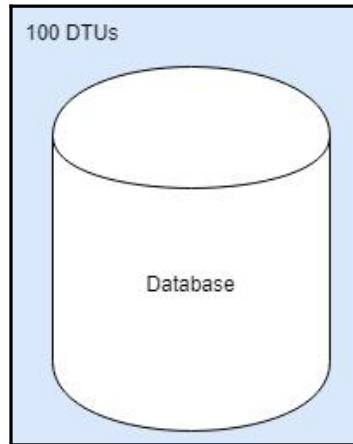

Microsoft Azure Search resources, services,...

Home > Resource groups > handsonazure-euw-rg > Everything

Everything

Free SQL Server License: (CTP2.0)SQL Server 2019 Developer on Ubuntu Server 16.04 LTS

Pricing: All | Operating System: All | Publisher: All

Results

| NAME | PUBLISHER | CATEGORY |
|---|-----------|----------|
|  Free SQL Server License: (CTP2.0)SQL Server 2019 Developer on Ubuntu Server 16.04 LTS | Microsoft | Compute |

Create a virtual machine

[Basics](#) [Disks](#) [Networking](#) [Management](#) [Guest config](#) [Tags](#) [Review + create](#)

Create a virtual machine that runs Linux or Windows. Select an image from Azure marketplace or use your own customized image. Complete the Basics tab then Review + create to provision a virtual machine with default parameters or review each tab for full customization.

Looking for classic VMs? [Create VM from Azure Marketplace](#)

PROJECT DETAILS

Select the subscription to manage deployed resources and costs. Use resource groups like folders to organize and manage all your resources.

| | |
|--------------------|--------------------------|
| * Subscription ⓘ | Visual Studio Enterprise |
| * Resource group ⓘ | handsonazure-euw-rg |

[Create new](#)

INSTANCE DETAILS

| | |
|--------------------------|---|
| * Virtual machine name ⓘ | handsonazure ✓ |
| * Region ⓘ | West Europe |
| Availability options ⓘ | No infrastructure redundancy required |
| * Image ⓘ | Free SQL Server License: (CTP2.0)SQL Server 2019 Developer on Ubuntu Server 16.04 LTS |
| * Size ⓘ | Standard DS13 v2 8 vcpus, 56 GB memory Change size |

[Browse all images and disks](#)

New server

* Server name
handsonazure-sql-server ✓
.database.windows.net

* Server admin login
kamil ✓

* Password
..... ✓

* Confirm password
..... ✓

* Location
West Europe ▾

Allow Azure services to access server ⓘ

Advanced Threat Protection ⓘ
[Start FREE Trial](#) [Not now](#)

FREE trial period of 60 days, and then 12.6495 EUR/server/month.

[Learn more](#) ↗

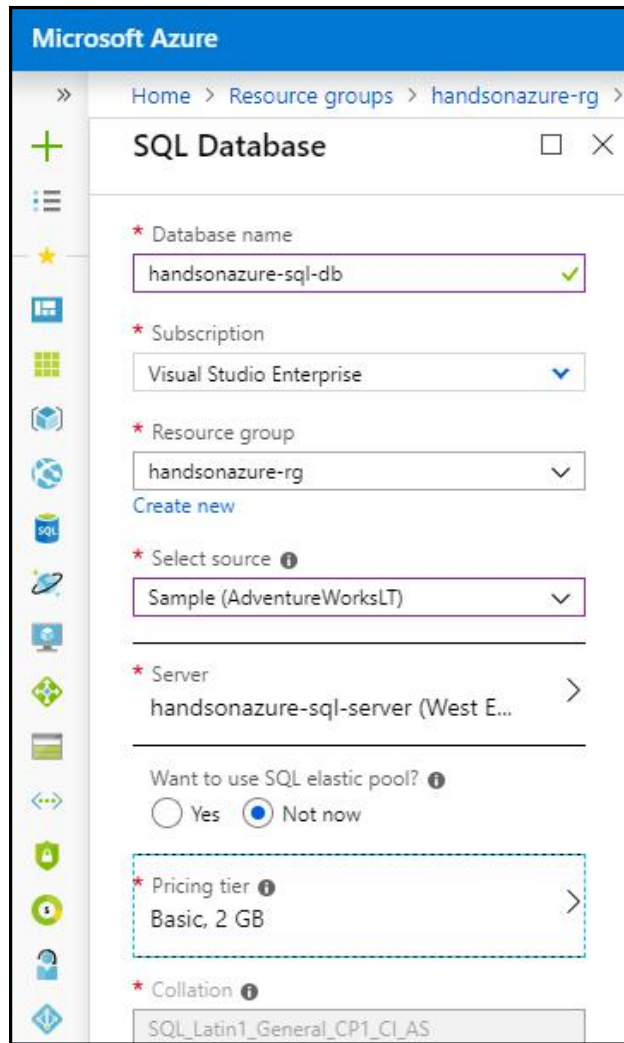

Configure □ ×

♥ Feedback

Basic
For less demanding workloads
Starting at 4.21 EUR / month

Standard
For workloads with typical performance requirements
Starting at 12.65 EUR / month

Premium
For IO-intensive workloads.
Starting at 392.13 EUR / month

vCore-based purchasing options
Click here to customize your performance using vCores >

DTUs [What is a DTU?](#)

5 (Basic)

Max data size

2 GB

Cost Summary

| | |
|----------------------------|-----------------|
| Cost per DTU (in EUR) | 0.84 |
| DTUs selected | x 5 |
| EST. COST PER MONTH | 4.21 EUR |

Configure

♥ Feedback

Basic
For less demanding workloads
Starting at 4.21 EUR / month

Standard
For workloads with typical performance requirements
Starting at 12.65 EUR / month

Premium
For IO-intensive workloads.
Starting at 392.13 EUR / month

DTUs [What is a DTU?](#)

200 (S4)

Max data size

2 GB

Configure

Feedback

Looking for basic, standard, premium?

General Purpose

Scalable compute and storage options

Up to 7,000 IOPS
5-10 ms latency
Starting at 105.80 EUR / month

Business Critical

High transaction rate and high resiliency

Up to 200,000 IOPS
1-2 ms latency
Starting at 211.74 EUR / month

Compute Generation

Gen4

up to 24 vCores
up to 168 GB memory

Gen5

up to 80 vCores
up to 408 GB memory

vCores [How do vCores compare with DTUs?](#)

4 vCores

Max data size

169 GB

ALLOCATED LOG STORAGE 50,7 GB

Cost Summary

| | |
|---|-------------------|
| Gen4 - General Purpose (GP_Gen4_4) | |
| Cost per vCore (in EUR) | 105.05 |
| vCores selected | x 4 |
| Cost per GB (in EUR) | 0.12 |
| Max storage selected (in GB) | x 219.7 |
| EST. COST PER MONTH | 445.57 EUR |

handsonazure-sql-database

SQL database

Search (Ctrl+/)

- Overview
- Activity log
- Tags
- Diagnose and solve problems
- Quick start
- Query editor (preview)
- Settings
 - Configure
 - Geo-Replication
 - Connection strings
 - Sync to other databases
 - Add Azure Search
 - Properties
 - Locks

Copy
Restore
Export
Set server firewall
Delete
Connect with...
Feedback

Resource group (change)
liczniknetvnext-develop-resourcegroup

Status
Online

Location
West Europe

Subscription (change)
Visual Studio Enterprise

Subscription ID
[REDACTED]

Tags (change)
[Click here to add tags](#)

Server name
handsonazure-sql-server.database.windows.net

Elastic pool
No elastic pool

Connection strings
[Show database connection strings](#)

Pricing tier
Basic

Oldest restore point
No restore point available

Resource utilization (handsonazure-sql-database)

1 hour
24 hours
7 days
View: Max

Home > Resource groups > liczniknetvnext-develop-resourcegroup > handsonazure-sql-database - Geo-Replication

handsonazure-sql-database - Geo-Replication

SQL database

Search (Ctrl+/) <<

Select a region on the map or from the Target Regions list to create a secondary database.

i You can now automatically manage replication, connectivity and failover of this database by adding it to failover group.

SERVER/DATABASE

PRIMARY

| | | |
|-------------------------------------|-------------|---|
| <input checked="" type="checkbox"/> | West Europe | handsonazure-sql-server/handsonazure-sql-database |
|-------------------------------------|-------------|---|

Settings

- Configure
- Geo-Replication**
- Connection strings
- Sync to other databases
- Add Azure Search
- Properties
- Locks
- Automation script

Security

- Advanced Threat Protection
- Auditing
- Dynamic Data Masking
- Transparent data encryption

Intelligent Performance

- Performance overview
- Performance recommendati...
- Query Performance Insight

Create secondary □ ×

Create geo-replicated secondaries to protect against prolonged datacenter outages. Secondaries have price implications. [Learn more](#) ↗

Region 🔒
West US

Database name
handsonazure-sql-database

* Secondary type 🔒
Readable

* Target server >
handsonazure-sql-server-second...

Elastic pool 🔒
None

* Pricing tier >
Basic, 2 GB

 You can now automatically manage replication, connectivity and failover of this database by adding it to failover group.

Failover group

Create a failover group to automatically failover databases in it.

Primary server
handsonazure-sql-server (westeu... 

* Secondary server
handsonazure-sql-server-second... 

* Failover group name
handsonazure-failover 
.database.windows.net

Read/Write failover policy
Automatic 

Read/Write grace period (hours)
1 hours 

Summary

| | |
|------------------------------------|---|
| Number of new standalone databases | 1 |
| Number of new elastic pools | 0 |

Monthly cost **EUR 0.00**

West US □ ×
Secondary database

Forced Failover Stop Replication

REGION
West US

DATABASE NAME
handsonazure-sql-database

SERVER
handsonazure-sql-server-secondary

PRICING TIER
Basic

STATUS
Readable

handsonazure-sql-database - Connection strings
SQL database

Search (Ctrl+/)

Settings

- Configure
- Geo-Replication
- Connection strings**
- Sync to other databases
- Add Azure Search
- Properties
- Locks

ADO.NET JDBC ODBC PHP

ADO.NET (SQL authentication)

```
Server=tcp:handsonazure-sql-server.database.windows.net,1433;Initial Catalog=handsonazure-sql-database;Persist Security Info=False;User ID=(your_...);Timeout=30;
```

[Download ADO.NET driver for SQL server](#)

Home > Resource groups > liczniknetvnext-develop-resourcegroup > handsonazure-sql-database > handsonazure-sql-server - SQL databases > handsonazure-sql-database > handsonazure-sql-server

handsonazure-sql-server

SQL server

Search (Ctrl+F)

+ New database + New pool Import database Reset password Move Delete Feedback

Resource group (change)
liczniknetvnext-develop-resourcegroup

Status
Available

Location
West Europe

Subscription (change)
Visual Studio Enterprise

Subscription ID
[REDACTED]

Tags (change)
Click here to add tags

Server admin
kamil

Firewalls and virtual net
[Show firewall settings](#)

Active Directory admin
Not configured

Notifications (0) Features (6)

All Security (4) Performance (1) Recovery (1)

| | | |
|---|---|---|
| <p>Active Directory admin</p> <p>Allows you to centrally manage identity and access to your Azure SQL databases.</p> <p>NOT CONFIGURED</p> | <p>Advanced Threat Protection</p> <p>Data Discovery & Classification, Vulnerability Assessment and Threat Detection.</p> <p>NOT CONFIGURED</p> | <p>Automatic tuning</p> <p>Monitors and tunes your database to optimize performance.</p> |
| <p>Failover groups</p> <p>Automatically manages replication, connectivity and failover for a set of databases.</p> <p>NOT CONFIGURED</p> | <p>Transparent data encryption</p> <p>Encryption at rest for your databases, backups, and logs.</p> <p>NOT CONFIGURED</p> | |

Copy Restore Export Set server firewall Delete Connect with... Feedback

Resource group (change)
liczniknetvnext-develop-resourcegroup

Set server firewall

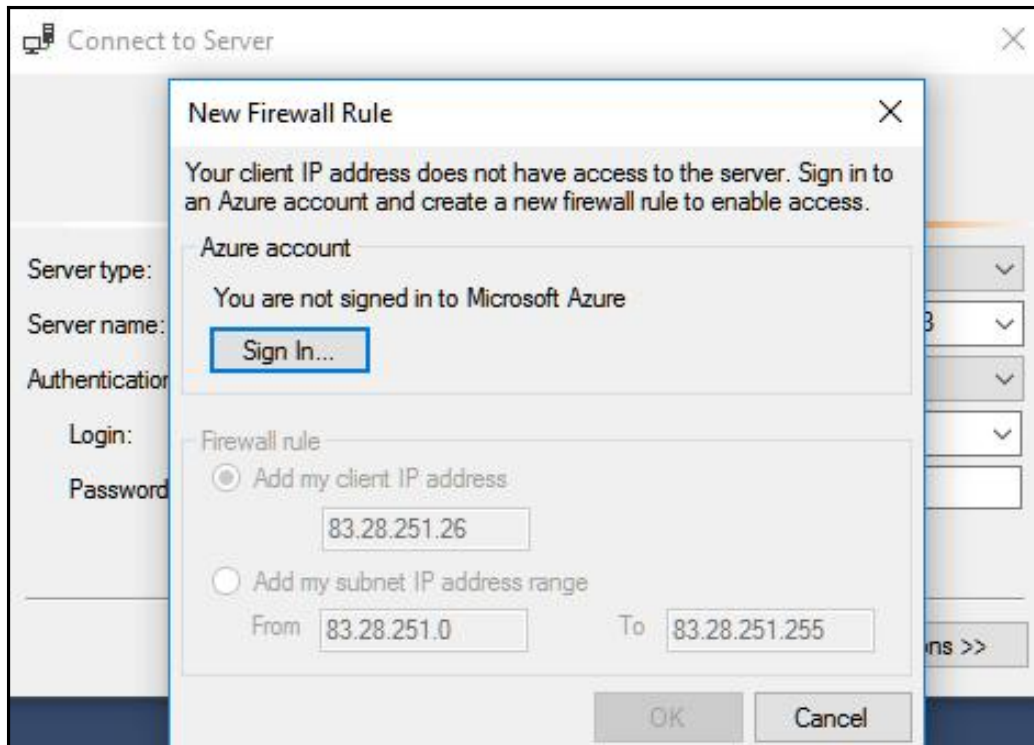

Firewall settings

□ ✕

handsonazure-sql-server (SQL server)

Save
✕ Discard
+ Add client IP

Connections from the IPs specified below provides access to all the databases in handsonazure-sql-server.

Allow access to Azure services

ON
OFF

Client IP address 83.28.251.26

| RULE NAME | START IP | END IP | |
|----------------------------|--------------|--------------|-----|
| | | | ... |
| ClientIPAddress_2018-9-24, | 83.28.251.26 | 83.28.251.26 | ... |

Connections from the VNET/Subnet specified below provides access to all databases in handsonazure-sql-server.

Virtual networks + Add existing virtual network + Create new virtual network

| RULE NA... | VIRTUAL ... | SUBNET | ADDRESS... | ENDPOI... | RESOURC... | SUBSCRIPT... | S... |
|--------------------------------|-------------|--------|------------|-----------|------------|--------------|------|
| No vnet rules for this server. | | | | | | | |

handsonazure-sql-database - Advanced Threat Protection
SQL database

Search (Ctrl+ /)

Settings Feedback

Connection strings

Sync to other databases

Add Azure Search

Properties

Locks

Automation script

Security

Advanced Threat Protection

Auditing

Dynamic Data Masking

Transparent data encryption

Intelligent Performance

Performance overview

Turn on Advanced Threat Protection for all databases on server. We invite you to a trial period for the first 60 days

Enable Advanced Threat Protection on the server



Data Discovery & Classification (preview)

0
TOTAL

Recommended columns to classify

| COLUMN | SENSITIVITY |
|--------|-------------|
|--------|-------------|

Data Discovery & Classification (preview)

 Save  Discard  Add classification  Feedback

Overview

Classification

[Learn more - Getting Started Guide](#) 

15 classified columns

Schema: 2 selected Table: 5 selected *Filter by column* Information type: 5 s... Sensitivity label: 2 sel...

| SCHEMA | TABLE | COLUMN | INFORMATION TYPE | SENSITIVITY LABEL | |
|---------|------------------|------------------------|---|---|---|
| SalesLT | SalesOrderHeader | TaxAmt | Financial <input type="button" value="v"/> | Confidential <input type="button" value="v"/> |  |
| SalesLT | SalesOrderHeader | CreditCardApprovalCode | Credit Card <input type="button" value="v"/> | Confidential <input type="button" value="v"/> |  |
| SalesLT | SalesOrderHeader | AccountNumber | Financial <input type="button" value="v"/> | Confidential <input type="button" value="v"/> |  |
| SalesLT | CustomerAddress | AddressType | Contact Info <input type="button" value="v"/> | Confidential <input type="button" value="v"/> |  |
| SalesLT | Customer | Phone | Contact Info <input type="button" value="v"/> | Confidential <input type="button" value="v"/> |  |
| SalesLT | Customer | PasswordSalt | Credentials <input type="button" value="v"/> | Confidential <input type="button" value="v"/> |  |
| SalesLT | Customer | PasswordHash | Credentials <input type="button" value="v"/> | Confidential <input type="button" value="v"/> |  |



Vulnerability Assessment



- HIGH RISK FAILURES
- MEDIUM RISK FAILURES
- LOW RISK FAILURES

Failed Checks

| SECURITY CHECK | RISK |
|--|--------|
| Server-level firewall rules should be tracked and maintained ... | High |
| 'dbo' user should not be used for normal service operation | Medium |
| Sensitive data columns should be classified | Medium |

...

handsonazure-sql-database - Auditing
SQL database

Search (Ctrl+/) Save Discard View audit logs Feedback

[Learn more - Getting Started](#)

i If Blob Auditing is enabled on the server, it will always apply to the database, regardless database settings.

! Potential cross-region reads/writes detected **i**

[View server settings](#)

i Server-level Auditing: **Disabled**

Auditing

ON OFF

Audit log destination (choose at least one):

Storage

Storage details
handsonazurefuna9d3

Log Analytics (Preview)

Event Hub (Preview)

Security

- Advanced Threat Protection
- Auditing**
- Dynamic Data Masking
- Transparent data encryption

Intelligent Performance

- Performance overview
- Performance recommendations
- Query Performance Insight

Audit records □ ×
 handsonazure-sql-database

Refresh Filter Open in OMS

 Click here to learn more about alternative methods for viewing & analyzing audit records. ↗

Audit source ⓘ
 Server audit Database audit

Show only audit records for SQL injections

Showing audit records up to Mon, 24 Sep 2018 07:31:53 UTC.

[Run in Query Editor](#) ⓘ

| EVENT TIME (UTC) | PRINCIPAL NAME | EVENT TYPE | ACTION STATUS |
|----------------------|----------------|-----------------|---------------|
| 9/24/2018 7:30:53 AM | kamil | BATCH COMPLETED | Succeeded |
| 9/24/2018 7:30:53 AM | kamil | BATCH COMPLETED | Succeeded |
| 9/24/2018 7:30:18 AM | kamil | RPC COMPLETED | Succeeded |
| 9/24/2018 7:30:18 AM | kamil | RPC COMPLETED | Succeeded |
| 9/24/2018 7:30:17 AM | kamil | RPC COMPLETED | Succeeded |

handsonazure-sql-database - Dynamic Data Masking
SQL database

Search (Ctrl+/)

Save Discard Add mask Feedback

Masking rules

| MASK NAME | MASK FUNCTION |
|-------------------------------|-------------------------------------|
| SalesLT_Customer_LastName | Default value (0, xxxx, 01-01-1900) |
| SalesLT_Customer_EmailAddress | Default value (0, xxxx, 01-01-1900) |

SQL users excluded from masking (administrators are always excluded) ⓘ

SQL users excluded from masking (administrators are always excluded) ✓

Recommended fields to mask

| SCHEMA | TABLE | COLUMN | |
|---------|----------|--------------|----------|
| SalesLT | Address | AddressID | Add mask |
| SalesLT | Address | AddressLine1 | Add mask |
| SalesLT | Address | AddressLine2 | Add mask |
| SalesLT | Customer | FirstName | Add mask |
| SalesLT | Customer | Phone | Add mask |

Load more

Navigation menu:

- Connection strings
- Sync to other databases
- Add Azure Search
- Properties
- Locks
- Automation script
- Security
 - Advanced Threat Protection
 - Auditing
 - Dynamic Data Masking
 - Transparent data encryption
- Intelligent Performance
 - Performance overview
 - Performance recommendations
 - Query Performance Insight
 - Automatic tuning

Add masking rule □ ×

Mask name

Select what to mask

Schema

Table

Column

Select how to mask

Masking field format

| Title | FirstName | MiddleName | LastName | Suffix | CompanyName | SalesPerson | EmailAddress |
|-------|-------------|------------|------------|--------|----------------------------|---------------------------|----------------------------------|
| Mr. | Orlando | N. | Gee | NULL | A Bike Store | adventure-works\pamela0 | orlando0@adventure-works.com |
| Mr. | Keith | NULL | Haris | NULL | Progressive Sports | adventure-works\david8 | keith0@adventure-works.com |
| Ms. | Donna | F. | Carreras | NULL | Advanced Bike Components | adventure-works\jillian0 | donna0@adventure-works.com |
| Ms. | Janet | M. | Gates | NULL | Modular Cycle Systems | adventure-works\jillian0 | janet1@adventure-works.com |
| Mr. | Lucy | NULL | Harrington | NULL | Metropolitan Sports Supply | adventure-works\shu0 | lucy0@adventure-works.com |
| Ms. | Rosmarie | J. | Carroll | NULL | Aerobic Exercise Company | adventure-works\linda3 | rosmarie0@adventure-works.com |
| Mr. | Dominic | P. | Gash | NULL | Associated Bikes | adventure-works\shu0 | dominic0@adventure-works.com |
| Ms. | Kathleen | M. | Garza | NULL | Rural Cycle Emporium | adventure-works\josé 1 | kathleen0@adventure-works.com |
| Ms. | Katherine | NULL | Harding | NULL | Sharp Bikes | adventure-works\josé 1 | katherine0@adventure-works.com |
| Mr. | Johnny | A. | Caprio | Jr. | Bikes and Motorbikes | adventure-works\garrett 1 | johnny0@adventure-works.com |
| Mr. | Christopher | R. | Beck | Jr. | Bulk Discount Store | adventure-works\jae0 | christopher1@adventure-works.com |
| Mr. | David | J. | Liu | NULL | Catalog Store | adventure-works\michael9 | david20@adventure-works.com |
| Mr. | John | A. | Beaver | NULL | Center Cycle Shop | adventure-works\pamela0 | john8@adventure-works.com |
| Ms. | Jean | P. | Handley | NULL | Central Discount Store | adventure-works\david8 | jean1@adventure-works.com |
| NULL | Jinghao | NULL | Liu | NULL | Chic Department Stores | adventure-works\jillian0 | jinghao1@adventure-works.com |
| Ms. | Linda | E. | Burnett | NULL | Travel Systems | adventure-works\jillian0 | linda4@adventure-works.com |

| Title | FirstName | MiddleName | LastName | Suffix | CompanyName | SalesPerson | EmailAddress | Phone |
|-------|-------------|------------|----------|--------|----------------------------|--------------------------|--------------|---------------------|
| Mr. | Orlando | N. | xxxx | NULL | A Bike Store | adventure-works\pamela0 | xxxx | 245-555-0173 |
| Mr. | Keith | NULL | xxxx | NULL | Progressive Sports | adventure-works\david8 | xxxx | 170-555-0127 |
| Ms. | Donna | F. | xxxx | NULL | Advanced Bike Components | adventure-works\jillian0 | xxxx | 279-555-0130 |
| Ms. | Janet | M. | xxxx | NULL | Modular Cycle Systems | adventure-works\jillian0 | xxxx | 710-555-0173 |
| Mr. | Lucy | NULL | xxxx | NULL | Metropolitan Sports Supply | adventure-works\shu0 | xxxx | 828-555-0186 |
| Ms. | Rosmarie | J. | xxxx | NULL | Aerobic Exercise Company | adventure-works\linda3 | xxxx | 244-555-0112 |
| Mr. | Dominic | P. | xxxx | NULL | Associated Bikes | adventure-works\shu0 | xxxx | 192-555-0173 |
| Ms. | Kathleen | M. | xxxx | NULL | Rural Cycle Emporium | adventure-works\josé1 | xxxx | 150-555-0127 |
| Ms. | Katherine | NULL | xxxx | NULL | Sharp Bikes | adventure-works\josé1 | xxxx | 926-555-0159 |
| Mr. | Johnny | A. | xxxx | Jr. | Bikes and Motorbikes | adventure-works\garrett1 | xxxx | 112-555-0191 |
| Mr. | Christopher | R. | xxxx | Jr. | Bulk Discount Store | adventure-works\jae0 | xxxx | 1 (11) 500 555-0132 |
| Mr. | David | J. | xxxx | NULL | Catalog Store | adventure-works\michael9 | xxxx | 440-555-0132 |
| Mr. | John | A. | xxxx | NULL | Center Cycle Shop | adventure-works\pamela0 | xxxx | 521-555-0195 |
| Ms. | Jean | P. | xxxx | NULL | Central Discount Store | adventure-works\david8 | xxxx | 582-555-0113 |
| NULL | Jinghao | NULL | xxxx | NULL | Chic Department Stores | adventure-works\jillian0 | xxxx | 928-555-0116 |
| Ms. | Linda | E. | xxxx | NULL | Travel Systems | adventure-works\jillian0 | xxxx | 121-555-0121 |

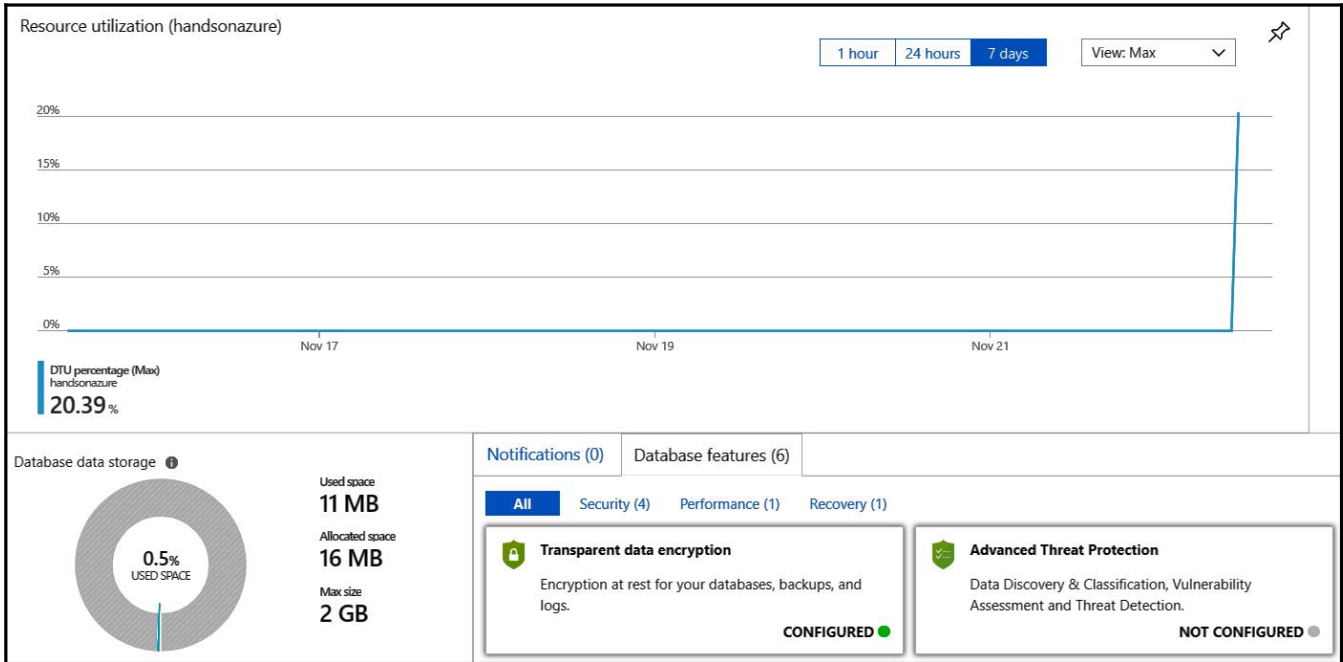

handsonazure-pool - Configure
SQL elastic pool

Search (Ctrl+/) Save Cancel Feedback

Basic
For less demanding workloads
Starting at 63.26 EUR / month

Standard
For workloads with typical performance requirements
Starting at 94.77 EUR / month

Pool settings Databases Per database settings

eDTUs 

Max data size **29,3 GB**

Overview
Activity log
Access control (IAM)
Tags
Diagnose and solve problems

Settings
Quick start
Configure
Locks
Automation script

Home > Resource groups > handsonazure-rg > handsonazure-sql-database - Alerts (Classic)

handsonazure-sql-database - Alerts (Classic)
SQL database

Search (Ctrl+/) Columns + Add metric alert (classic) + Add activity log alert

* Subscription Visual Studio Enterprise Source All sources

Visual Studio Enterprise > handsonazure-rg > handsonazure-sql-database

Search within displayed alerts...

| NAME | STATUS |
|-----------------------|--------|
| No results to display | |

Connection strings
Sync to other databases
Add Azure Search
Properties
Locks
Automation script

Security
Advanced Threat Protection

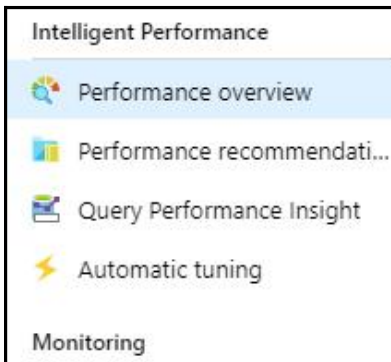

Home > Resource groups > handsonazure-rg > handsonazure-sql-database - Performance recommendations

handsonazure-sql-database - Performance recommendations

SQL database

Search (Ctrl+/) << Automate View discarded Getting started Feedback

Connection strings
Sync to other databases
Add Azure Search
Properties
Locks
Automation script

Security

- Advanced Threat Protection
- Auditing
- Dynamic Data Masking

Recommendations

| ACTION | RECOMMENDATION DESCRIPTION |
|---|----------------------------|
| We analyzed your database and found that your database was created recently. At this time, we don't have any recommendations. | |

Tuning history

| ACTION | RECOMMENDATION DESCRIPTION |
|---|----------------------------|
| There are currently no operations to display. Once you apply a recommendation, its status will be displayed here. | |



Automatic tuning

Apply

Revert to defaults



Azure SQL Database built-in intelligence automatically tunes your databases to optimize performance. [Click here to learn more about automatic tuning.](#)

Inherit from: ⓘ

Server

Azure defaults

Don't inherit



The database is inheriting automatic tuning configuration from the server. You can set the configuration to be inherited by going to: [Server tuning settings](#)



The database is inheriting settings from the server, but the server is in the unspecified state. Please specify the automatic tuning state on the server.

Configure the automatic tuning options ⓘ

| OPTION | DESIRED STATE |
|--------------|--|
| FORCE PLAN | <input type="checkbox"/> ON <input type="checkbox"/> OFF <input checked="" type="checkbox"/> INHERIT |
| CREATE INDEX | <input type="checkbox"/> ON <input type="checkbox"/> OFF <input checked="" type="checkbox"/> INHERIT |
| DROP INDEX | <input type="checkbox"/> ON <input type="checkbox"/> OFF <input checked="" type="checkbox"/> INHERIT |

Chapter 17: Big Data Storage - Azure Data Lake

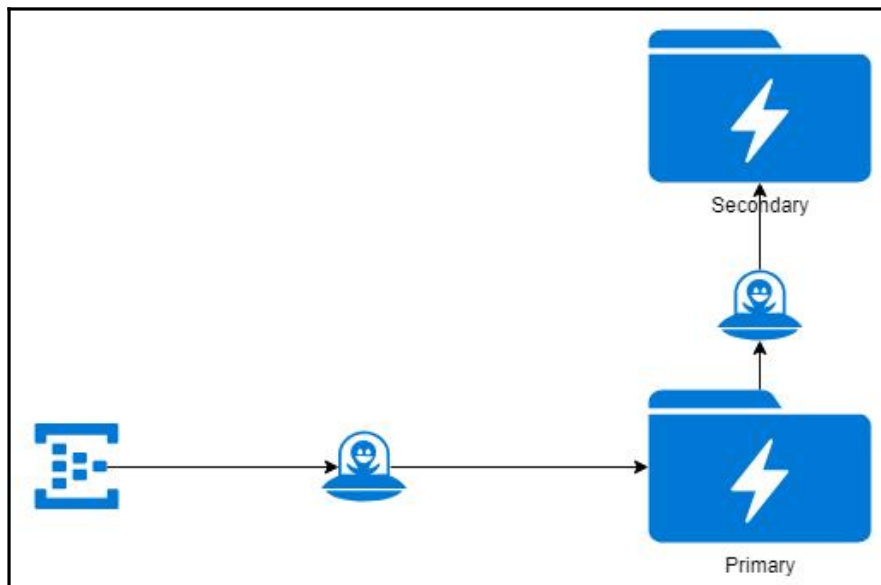
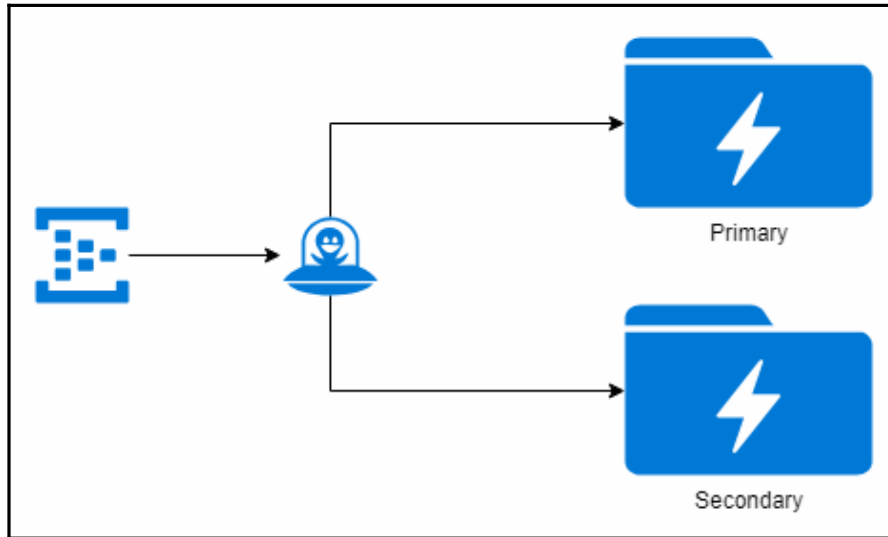

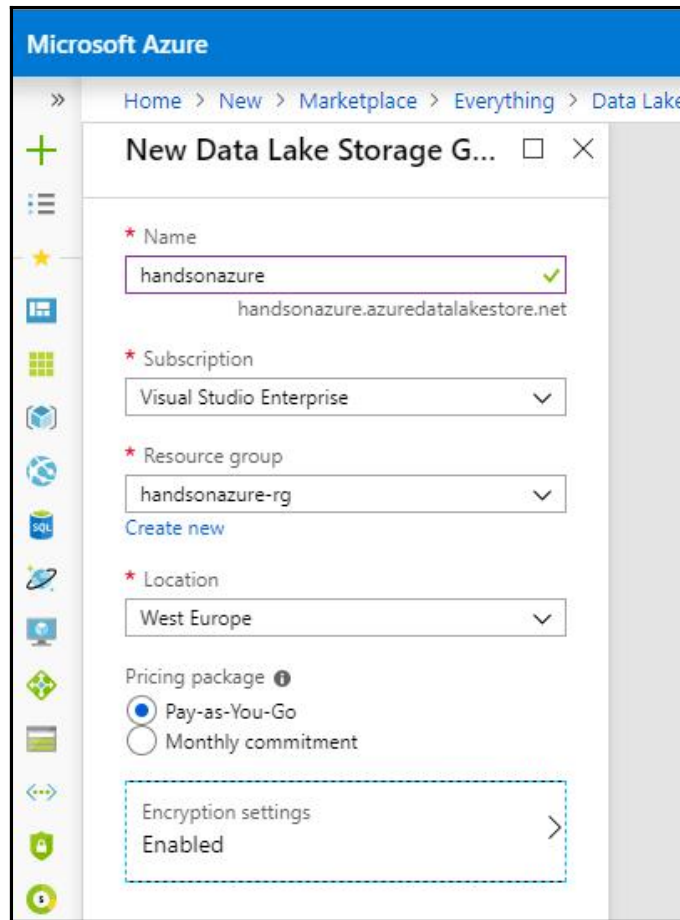

Home > Resource groups > handsonazure-rg > handsonazure

handsonazure

Data Lake Storage Gen1

Search (Ctrl+/)

Delete Data explorer

Essentials

handsonazure

Pay-as-You-Go ⓘ Estimated cost to date ⓘ

wrzesień 2018 **0,00 USD**

[Pricing tier info](#)

Total storage utilization

1.01.1970

Total storage utilization **0 bytes** Data at rest **0 bytes** Metadata ⓘ **0 bytes**

Settings

- Encryption
- Firewall
- Pricing tier
- Properties
- Locks
- Automation script

Data Lake Storage Gen1

- Quick start
- Data explorer

Microsoft Azure Storage Explorer

File Edit View Help

EXPLORER

Search for resources

Collapse All Refresh All

Quick Access

- Development (Key)
- Local & Attached
- Cosmos DB Accounts (Preview)
- Data Lake Store (Preview)
- Storage Accounts
- Visual Studio Enterprise (kamz@demant-techn...
- Data Lake Store (Preview)
 - handsonazure
- Storage Accounts

handsonazure

Upload Download Pin to Quick access Open New Folder Copy URL Select All Copy Paste Rename Move Delete

handsonazure

| Name | Last Modified | Content Type |
|-----------------------------------|---------------|--------------|
| No data available in this account | | |

Home > Resource groups > handsonazure-rg > handsonazure

handsonazure
Data Lake Storage Gen1

Search (Ctrl+*/*)

- Overview
- Activity log
- Access control (IAM)
- Tags
- Diagnose and solve problems

Delete Data explorer

Essentials

handsonazure

Pay-as-You-Go ⁱ

Estimated cost to date ⁱ

wrzesień 2018

Pricing tier info

0,00 USD

Home > Resource groups > handsonazure-rg > handsonazure > Data explorer > handsonazure

Data explorer
handsonazure

handsonazure
Data Lake Storage Gen1

Filter New folder Upload Access Rename folder Folder properties Delete folder More

handsonazure

| NAME | SIZE | LAST MODIFIED |
|-----------------|---------|------------------------|
| 11047_01_01.PNG | 16,5 KB | 29.09.2018, 3:31:31 PM |
| 11047_01_02.PNG | 26,3 KB | 29.09.2018, 3:31:36 PM |
| 11047_01_03.PNG | 16,6 KB | 29.09.2018, 3:31:36 PM |
| 11047_01_05.PNG | 65,8 KB | 29.09.2018, 3:33:01 PM |
| 11047_01_06.PNG | 7,55 KB | 29.09.2018, 3:33:01 PM |
| 11047_01_07.PNG | 13,4 KB | 29.09.2018, 3:33:01 PM |
| 11047_01_08.PNG | 24,8 KB | 29.09.2018, 3:33:01 PM |

Filter

Name

Type

2 selected

Last modified

After

2018-09-01 00:00:00

File size

Greater than

Size (MB)

100

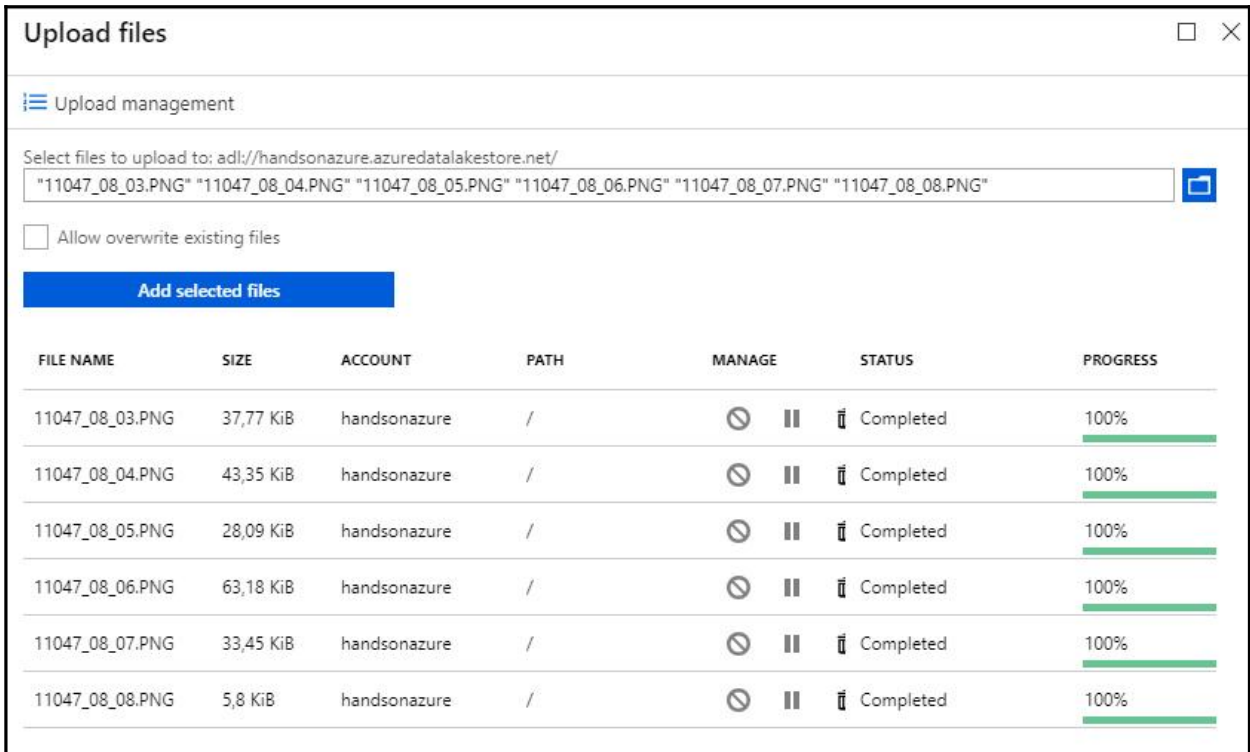
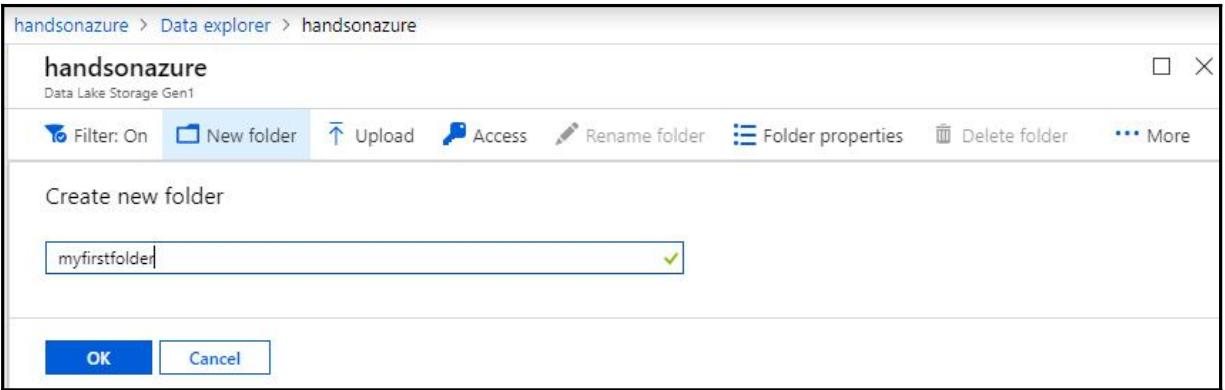

Upload files

Upload management

Select files to upload to: adl://handsonazure.azuredatalakestore.net/

"11047_01_01.PNG" 📁

Allow overwrite existing files

Add selected files

| FILE NAME | SIZE | ACCOUNT | PATH | MANAGE | STATUS | PROGRESS |
|-----------------|-----------|--------------|------|--------|------------------------------|----------|
| 11047_01_01.PNG | 16,48 KiB | handsonazure | / | 🛑 🛑 | Failed. Upload Error for ... | 0% |

Upload Error for 11047_01_01.PNG 15:46

FileAlreadyExistsException: [8788d883-e905-4397-91e6-650526c9ebae][Op=CREATE][[d_41::MoveNext:0x83090009]]
 Path /11047_01_01.PNG already exists

Access

/(Folder)

+ Add
 📁 Save
 ✕ Discard
 📄 Advanced

Your permissions

[redacted] effective permissions on this folder are: Read,Write,Execute.

i You have superuser privileges on this account.

| Owners | Read | Write | Execute |
|---|------|-------|---------|
| 👤 Kamil Mrzygłód (KAMZ) | ☑ | ☑ | ☑ |
| 👤 00000000-0000-0000-0000-000000000000 | ☑ | ☑ | ☑ |

Assigned permissions

No entries.

Everyone else

🌐
Users not covered above will be limited by these permissions
☐
☐
☐

Assign permissions

- * Select user or group
Configure required settings >
- * Select permissions
Configure required settings >

Select permissions

Permissions

Read
 Write
 Execute

Add to:

This folder
 This folder and all children

Add as:

An access permission entry
 A default permission entry
 An access permission entry and a default permission entry

| NAME | SIZE | LAST MODIFIED | Folder |
|-----------------|---------|------------------------|--|
| myfirstfolder | | 29.09.2018, 3:41:51 PM | <ul style="list-style-type: none"> Pin to dashboard Rename folder Access Share (Preview) Folder properties Delete folder |
| 11047_01_01.PNG | 16,5 KB | 29.09.2018, 3:31:31 PM | |
| 11047_01_02.PNG | 26,3 KB | 29.09.2018, 3:31:36 PM | |
| 11047_01_03.PNG | 16,6 KB | 29.09.2018, 3:31:36 PM | |
| 11047_01_05.PNG | 65,8 KB | 29.09.2018, 3:33:01 PM | |
| 11047_01_06.PNG | 7,55 KB | 29.09.2018, 3:33:01 PM | |

handsonazure

Upload Download Pin to Quick access Open New Folder Copy URL Select All Copy Paste Rename Move Delete Folder Statistics Refresh

handsonazure Search by prefix

| Name | Last Modified | Content Type | Size | Expired | Permission |
|-----------------|-------------------------------|--------------|---------|---------|------------|
| myfirstfolder | Sat, 29 Sep 2018 13:41:51 GMT | Folder | 0 B | | RWXRWX--- |
| 11047_01_01.PNG | Sat, 29 Sep 2018 13:31:31 GMT | File | 16.5 KB | N/A | RWXRWX--- |
| 11047_01_02.PNG | Sat, 29 Sep 2018 13:31:36 GMT | File | 26.3 KB | N/A | RWXRWX--- |
| 11047_01_03.PNG | Sat, 29 Sep 2018 13:31:36 GMT | File | 16.6 KB | N/A | RWXRWX--- |
| 11047_01_05.PNG | Sat, 29 Sep 2018 13:33:01 GMT | File | 65.8 KB | N/A | RWXRWX--- |
| 11047_01_06.PNG | Sat, 29 Sep 2018 13:33:01 GMT | File | 7.5 KB | N/A | RWXRWX--- |
| 11047_01_07.PNG | Sat, 29 Sep 2018 13:33:01 GMT | File | 13.4 KB | N/A | RWXRWX--- |
| 11047_01_08.PNG | Sat, 29 Sep 2018 13:33:01 GMT | File | 24.8 KB | N/A | RWXRWX--- |
| 11047_08_03.PNG | Sat, 29 Sep 2018 13:44:15 GMT | File | 37.8 KB | N/A | RWXRWX--- |
| 11047_08_04.PNG | Sat, 29 Sep 2018 13:44:15 GMT | File | 43.3 KB | N/A | RWXRWX--- |
| 11047_08_05.PNG | Sat, 29 Sep 2018 13:44:15 GMT | File | 28.1 KB | N/A | RWXRWX--- |
| 11047_08_06.PNG | Sat, 29 Sep 2018 13:44:15 GMT | File | 63.2 KB | N/A | RWXRWX--- |
| 11047_08_07.PNG | Sat, 29 Sep 2018 13:44:15 GMT | File | 33.4 KB | N/A | RWXRWX--- |
| 11047_08_08.PNG | Sat, 29 Sep 2018 13:44:15 GMT | File | 5.8 KB | N/A | RWXRWX--- |

Home > Resource groups > handsonazure-rg > handsonazure - Access control (IAM)

handsonazure - Access control (IAM)

Data Lake Storage Gen1

Search (Ctrl+J)

+ Add Remove Roles Refresh Help

Name: Search by name or email Type: All Role: 2 selected Scope: All scopes Group by: Role

4 items (1 Users, 3 Service Principals)











| NAME | TYPE | ROLE |
|---------------------------------|------|-------------|
| CONTRIBUTOR | | |
| [Redacted] | App | Contributor |
| [Redacted] | App | Contributor |
| [Redacted] | App | Contributor |
| OWNER | | |
| Unknown user kamz@oticon.com | User | Owner |

Navigation: Overview, Activity log, Access control (IAM), Tags, Diagnose and solve problems, Settings (Encryption, Firewall, Pricing tier, Properties, Locks, Automation script), Data Lake Storage Gen1, Quick start

Roles

handsonazure



| NAME | USERS | GROUPS |
|---|-------|--------|
|  Owner ⓘ | 0 | 1 |
|  Contributor ⓘ | 3 | 0 |
|  Reader ⓘ | 0 | 0 |
|  Log Analytics Contributor ⓘ | 0 | 0 |
|  Log Analytics Reader ⓘ | 0 | 0 |
|  Managed Applications Reader ⓘ | 0 | 0 |
|  Monitoring Contributor ⓘ | 0 | 0 |
|  Monitoring Metrics Publisher ⓘ | 0 | 0 |
|  Monitoring Reader ⓘ | 0 | 0 |
|  Resource Policy Contributor (Preview) ⓘ | 0 | 0 |
|  User Access Administrator ⓘ | 0 | 0 |

handsonazure - Firewall

Data Lake Storage Gen1

Search (Ctrl+/) <<

- Overview
- Activity log
- Access control (IAM)
- Tags
- Diagnose and solve problems

Settings

- Encryption
- Firewall**
- Pricing tier
- Properties
- Locks

Save Discard Add client IP

Enable firewall **ON** OFF



"Allow Azure services" must be turned on to allow Azure services and application issues. This option is also required for other services such as Data Factory, Data

Allow access to Azure services **ON** OFF

Client IP address 83.28.251.26

RULE NAME

No entries.

Chapter 18: Scaling Azure Applications

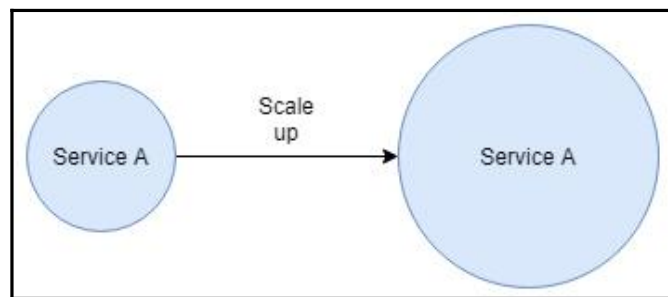
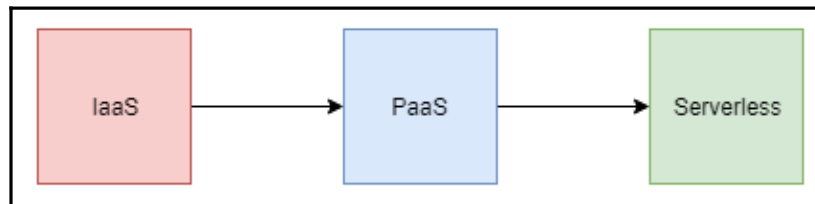
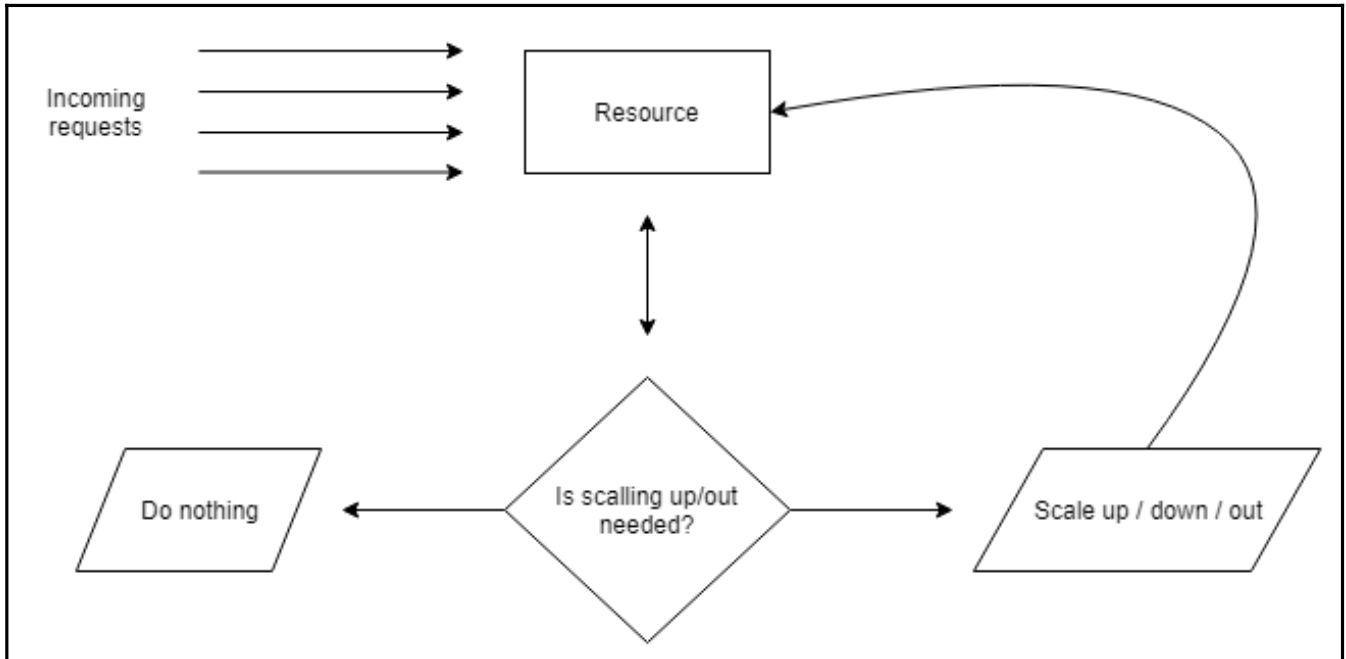

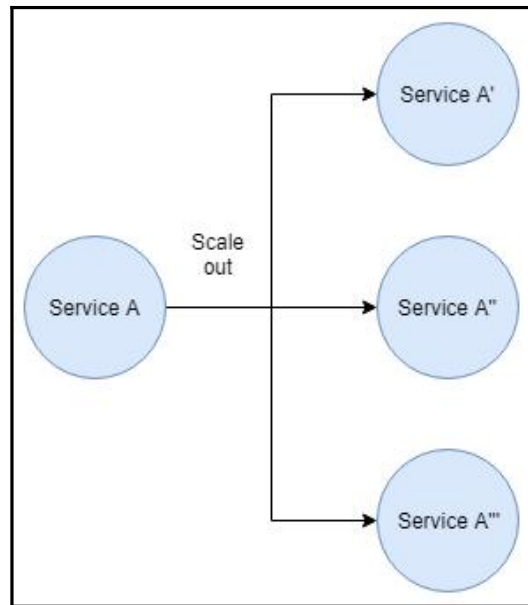

Home > Resource groups > handsonazure-euw-rg > handsonazure-euw-webapp - Scale out (App Service plan)

handsonazure-euw-webapp - Scale out (App Service plan)

App Service

Search (Ctrl+/)

Quickstart
Deployment credentials
Deployment slots
Deployment options
Deployment Center (Preview)

Settings

Save Discard Disable autoscale Refresh

Configure Run history JSON Notify

Override condition

Instance count

Autoscale is not supported for this Tier

Home > Resource groups > handsonazure-euw-rg > handsonazure-euw-webapp - Scale out (App Service plan)

handsonazure-euw-webapp - Scale out (App Service plan)

App Service

Search (Ctrl+/) << Save Discard Disable autoscale Refresh

Configure Run history JSON Notify

Override condition

Instance count  9

Your autoscale configuration is disabled. To reinstate your configuration, enable autoscale.

Enable autoscale

Quickstart

Deployment credentials

Deployment slots

Deployment options

Deployment Center (Preview)

Settings

Application settings

Authentication / Authorizati...

Save Discard Disable autoscale Refresh

Configure Run history JSON Notify

* Autoscale setting name handsonazure-euw-webapp-autoscale ✓

Resource group handsonazure-euw-rg ✓

Default Auto created scale condition ✎

Delete warning ⓘ The very last or default recurrence rule cannot be deleted. Instead, you can disable autoscale to turn off autoscale.

Scale mode Scale based on a metric Scale to a specific instance count

Scale out and scale in your instances based on metric. For example: 'Add a rule that increases instance count by 1 when CPU percentage is above 70%'

Rules ⓘ It is recommended to have at least one scale in rule

+ Add a rule

Instance limits

| Minimum ⓘ | Maximum ⓘ | Default ⓘ |
|-----------|-----------|-----------|
| 1 | 2 | 1 |

Schedule **This scale condition is executed when none of the other scale condition(s) match**

Scale rule ✕

Metric source
Current resource (handsonazure01) ▼

Resource type
App Service plans ▼

Resource
handsonazure01 ▼

Criteria

* Time aggregation ⓘ
Average ▼

* Metric name
CPU Percentage ▼
1 minute time grain

* Time grain statistic ⓘ
Average ▼

* Operator
Greater than ▼

* Threshold
70

Application settings

| APP SETTING NAME | VALUE |
|---|---|
| APPINSIGHTS_INSTRUMENTATIONKEY | a366cef1-1189-4dc1-bba2-e681eff4f022 |
| AzureWebJobsStorage | DefaultEndpointsProtocol=https;AccountName= |
| FUNCTIONS_EXTENSION_VERSION | ~2 |
| FUNCTIONS_WORKER_RUNTIME | dotnet |
| WEBSITE_CONTENTAZUREFILECONNECTIONSTRING | DefaultEndpointsProtocol=https;AccountName= |
| WEBSITE_CONTENTSHARE | handsonazure-euw-functionappa83c |
| WEBSITE_NODE_DEFAULT_VERSION | 8.11.1 |
| WEBSITE_MAX_DYNAMIC_APPLICATION_SCALE_OUT | 3 |

[+ Add new setting](#)

Overall Health

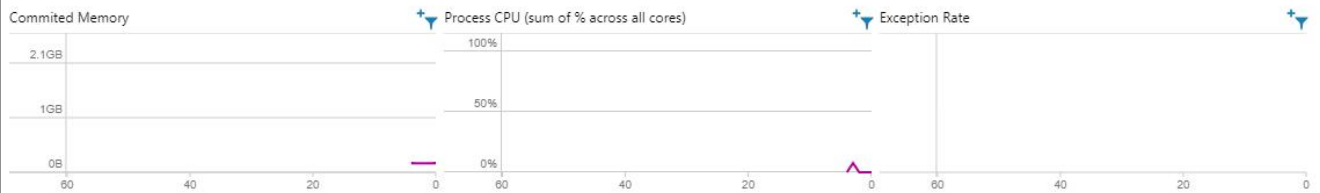

Servers

[Select columns](#)

| SERVER NAME | REQUESTS | REQUESTS FAILED | CPU TOTAL | COMMITTED MEMORY |
|--|----------|-----------------|-----------|------------------|
| 29d7836fa92471d531bd938b9669c935e5010efa23a18a34752... | 0/sec | 0/sec | 2% | 164 MB |

Cluster configuration

Configure node types and diagnostics

Node types

Node types define the scale sets that will be used to manage your cluster. You specify between 1 and 3 in the portal. [Learn more about node types](#)

* Node type count

1 2 3

* Node type 1 (Primary)

[Configure required settings](#)

+ Show optional settings

Node type configuration

Node type 1 (Primary)

* Node type name

tier1

Durability tier

Bronze

* Virtual machine size

Select VM size

Single node cluster

Initial VM scale set capacity

5

Custom endpoints

80, 83, 8087

Configure advanced settings

Choose a size

Browse the available sizes and their features

Prices presented are estimates in your local currency that include only Azure infrastructure costs and any discounts for the subscription and location. The prices don't include any applicable software costs. Recommended sizes are determined by the publisher of the selected image based on hardware and software requirements.

vCPUs: 1 to 128 | Minimum memory (GiB): 0

★ Recommended | View all

| D1_V2 Standard | D2_V2 Standard | D3_V2 Standard |
|-----------------------|-----------------------|-----------------------|
| 1 vCPU | 2 vCPUs | 4 vCPUs |
| 3.5 GB | 7 GB | 14 GB |
| 4 Data disks | 8 Data disks | 16 Data disks |
| 2x500 Max IOPS | 4x500 Max IOPS | 8x500 Max IOPS |
| 50 GB Local SSD | 100 GB Local SSD | 200 GB Local SSD |
| Load balancing | Load balancing | Load balancing |
| 1,2,3 Zones | 1,2,3 Zones | 1,2,3 Zones |
| 42.66 | 85.33 | 170.66 |
| EUR/MONTH (ESTIMATED) | EUR/MONTH (ESTIMATED) | EUR/MONTH (ESTIMATED) |

Home > [Resource groups](#) > handsonazure-euw-rg > tier1 - Scaling

tier1 - Scaling

Virtual machine scale set

Search (Ctrl+/)

- Overview
- Activity log
- Access control (IAM)
- Tags
- Diagnose and solve problems

Settings

- Instances
- Scaling
- Storage

Save Discard Disable autoscale Refresh

Configure Run history JSON Notify

Override condition

Instance count

Your autoscale configuration is disabled. To reinstate your configuration, enable autoscale.

[Enable autoscale](#)

Chapter 19: Serving Static Content Using Azure CDN

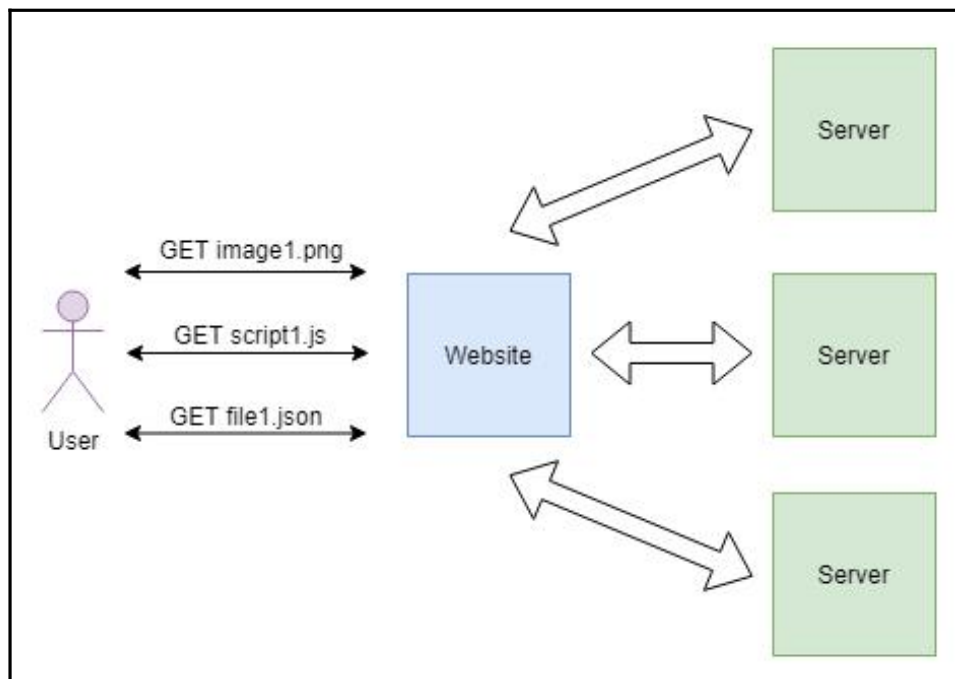
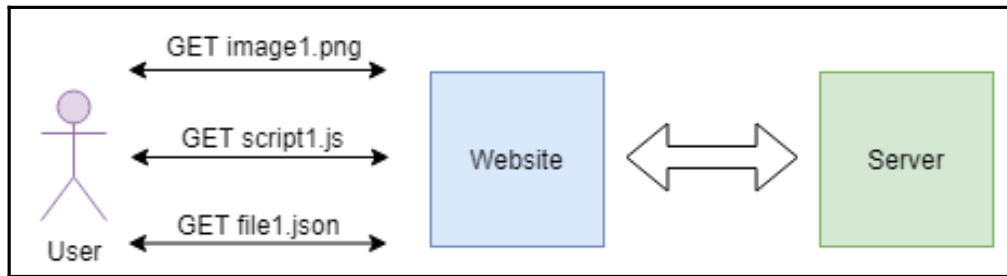

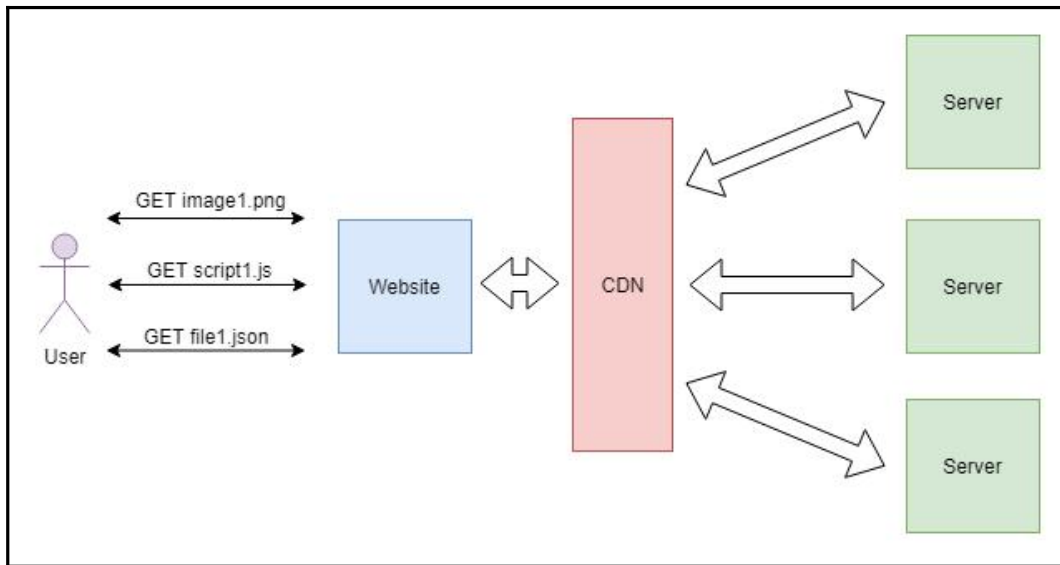

Microsoft Azure

Home > New > Marketplace > Everything > CDN > CDN profile

CDN profile

- * Name: ✓
- * Subscription: ▼
- * Resource group: ▼
- Create new
- * Resource group location ⓘ: ▼
- * Pricing tier [\(View full pricing details\)](#): ▼
- Create a new CDN endpoint now

CDN profile

* Name
handsonazure-cdn ✓

* Subscription
Visual Studio Enterprise

* Resource group
(New) handsonazure-euw-rg

Create new

* Resource group location ⓘ
West Europe

* Pricing tier (View full pricing details)
Standard Verizon

Create a new CDN endpoint now

Choose your pricing tier

Browse the available plans and their features

The premium pricing tier adds powerful features, advanced analytics, and more. Price varies based on region and data usage. [Learn more](#)

| P1 Premium Verizon | S1 Standard Verizon | S2 Standard Akamai |
|---|---|---|
| All standard features | Endpoint HTTPS | Endpoint HTTPS |
| Token authentication | Custom domain HTTPS | Content Purge |
| Performance analytics | Content Purge/Load | Compression |
| Realtime analytics | Compression | Geo-filtering |
| Mobile device rules | Geo-filtering | Media optimization |
| Custom rules engine | Core analytics | Core analytics |
| Cache/Header settings | Dynamic delivery | Dynamic delivery |
| URL redirect/rewrite | | |
| 0.143 MIN EUR PER GB UP TO 10TB | 0.073 MIN EUR PER GB UP TO 10TB | 0.073 MIN EUR PER GB UP TO 10TB |
| S3 Standard Microsoft | | |
| Endpoint HTTPS | | |
| Custom domain HTTPS | | |
| Content Purge | | |
| Compression | | |
| Geo-filtering | | |
| Core analytics | | |
| *Preview price 50% off | | |
| 0.036 MIN EUR PER GB UP TO 10TB | | |

Home > Resource groups > handsonazure-euw-rg > handsonazure-cdn

handsonazure-cdn

CDN profile

[+ Endpoint](#)
[Manage](#)
[Purge](#)
[Move](#)
[Delete](#)

- [Overview](#)
- [Activity log](#)
- [Access control \(IAM\)](#)
- [Tags](#)
- [Diagnose and solve problems](#)

Settings

- [Properties](#)
- [Quickstart](#)
- [Locks](#)
- [Automation script](#)

Support + troubleshooting

- [Resource health](#)
- [New support request](#)

Resource group (change)
handsonazure-euw-rg

Status
Active

Location
West Europe

Subscription (change)
Visual Studio Enterprise

Subscription ID
[REDACTED]

Pricing Tier
Standard Verizon

[Endpoints](#)

| HOSTNAME | STATUS | PROTOCOL | ORIGIN |
|---|--------|----------|--------|
| No endpoints are associated with this profile | | | |

Add an endpoint ✕

Allows configuring content delivery behavior and access.

* Name
 ✓
.azureedge.net

* Origin type
 ▼

* Origin hostname ⓘ
 ▼

Origin path ⓘ

Origin host header ⓘ
 ✓

Protocol ⓘ Origin port ⓘ

HTTP

HTTPS

Optimized for ⓘ
 ▼

 Endpoints

| HOSTNAME | STATUS | PROTOCOL | ORIGIN TYPE |
|----------------------------|-----------|-------------|-------------|
| handsonazure.azureedge.net | ✓ Running | HTTP, HTTPS | Storage |

Home > Resource groups > handsonazure-euw-rg > handsonazure-cdn > handsonazure

handsonazure
Endpoint

+ Custom domain
Purge
↑ Load
■ Stop
🗑 Delete

Overview

- Activity log
- Access control (IAM)
- Tags
- Diagnose and solve problems

Settings

- Origin
- Custom domains
- Compression
- Caching rules
- Geo-filtering
- Optimization
- Locks
- Automation script

Resource group (change)
handsonazure-euw-rg

Status
Running

Location
West Europe

Subscription (change)
Visual Studio Enterprise

Subscription ID
[REDACTED]

Endpoint hostname
<https://handsonazure.azureedge.net>

Origin hostname
[https://handsonazure.blob.core.](https://handsonazure.blob.core.windows.net)

Protocols
HTTP, HTTPS

Optimization type
General web delivery

Custom domains

| HOSTNAME | CUSTOM HTTPS | DETAILS |
|--|--------------|---------|
| There are no custom domains to display | | |

Home > Resource groups > handsonazure-euw-rg > handsonazure-cdn > handsonazure - Compression

handsonazure - Compression

Endpoint

Search (Ctrl+/) Save Discard

- Overview
- Activity log
- Access control (IAM)
- Tags
- Diagnose and solve problems

Settings

- Origin
- Custom domains
- Compression
- Caching rules
- Geo-filtering
- Optimization
- Locks
- Automation script

Monitoring

- Diagnostics logs

Support + troubleshooting

- New support request

About This Feature

Compress files on the fly via CDN to reduce size and improve performance types list to fine tune which content formats to compress. Already compress see much additional gain from compression. Note that files are only comp cache. Compressed by the origin can still be delivered compressed to the

[Learn more](#)

Configure

Compression Off On

Delete

FORMATS TO COMPRESS

- text/plain
- text/html
- text/css
- text/javascript
- application/x-javascript
- application/javascript
- application/json
- application/xml

Home > Resource groups > handsonazure-euw-rg > handsonazure-cdn > handsonazure - Caching rules

handsonazure - Caching rules

Endpoint

Search (Ctrl+/) Save Discard

- Overview
- Activity log
- Access control (IAM)
- Tags
- Diagnose and solve problems

Settings

- Origin
- Custom domains
- Compression
- Caching rules
- Geo-filtering
- Optimization
- Locks
- Automation script

Monitoring

- Diagnostics logs

Support + troubleshooting

- New support request

About This Feature

Control how CDN caches your content, including how unique query strings are handled and whether origin cache directive headers are used to decide caching duration. You can set global rules which affect all requests, as well as custom rules for more specific conditions such as a folder or file.

[Learn more](#)

Optimized for **General web delivery**

Default caching behavior **Set if missing**

Default cache expiration duration **7 days**

Global caching rules

These rules affect the CDN caching behavior for all requests, and can be overridden using Custom Cache Rules below for certain scenarios. Note that the Query string caching behavior setting does not affect files that are not cached by the CDN.

Caching behavior **Override**

Cache expiration duration

| Days | Hours | Minutes | Seconds |
|------|-------|---------|---------|
| 0 | 12 | 0 | 0 |

Query string caching behavior **Ignore query strings**

Custom caching rules

Create caching rules based on specific match conditions. These rules override the default settings above, and are evaluated from top to down. This means that rules lower default behavior. Therefore it makes more sense to have more specific rules towards the bottom of the list so they are not overwritten by a general rule under them. For

Move up Move down Move to top Move to bottom Insert Delete

| MATCH CONDITION | MATCH VALUE(S) | CACHING BEHAVIOR | DAYS |
|---|----------------|------------------|------|
| <input type="checkbox"/> UriFileExtension | png | SetIfMissing | 7 |
| <input type="checkbox"/> | | | 0 |

Home > Resource groups > handsonazure-euw-rg > handsonazure-cdn > handsonazure - Geo-filtering

handsonazure - Geo-filtering

Endpoint

Search (Ctrl+/) Save Discard

- Overview
- Activity log
- Access control (IAM)
- Tags
- Diagnose and solve problems

Settings

- Origin
- Custom domains
- Compression
- Caching rules
- Geo-filtering

About This Feature

Create geo-filtering rules on specific paths on your endpoint to block or allow content in the selected countries. The path can match a single file (e.g. '/pictures/city.png') or a folder (e.g. '/pictures/' or '/pictures/cities/'). When a folder is specified (i.e. with a trailing slash), the filter applies to all files and sub-folders under it.

[Learn more](#)

Configure

Move up Move down Move to top Move to bottom Insert Delete

| PATH | ACTION | COUNTRY CODES |
|---|--------|-----------------|
| <input type="checkbox"/> /forbidden_eu | Block | AT,AL,AD,BY,BG, |
| <input type="checkbox"/> /forbidden_us | Block | US |
| <input type="checkbox"/> /pictures/ or /pictures/city.png | | 0 selected |

The screenshot displays the Azure portal settings interface. On the left is a navigation sidebar with the following items: Deployment slots, Deployment Center, Settings (sub-section), Application settings, Authentication / Authorization, Application Insights, Managed service identity, Backups, Custom domains, SSL settings, Networking (highlighted in blue), and Scale up (App Service plan). The main content area shows two settings cards. The first card is for 'Azure CDN', featuring a cloud icon, the title 'Azure CDN', a description 'Secure, reliable content delivery with broad global reach and rich features', a 'Learn More' link, and a 'Configure Azure CDN for your app' link. The second card is for 'IP Restrictions', featuring a blue circle with a diagonal slash icon, the title 'IP Restrictions', a description 'Define and manage rules that control access to your app for range of IP addresses', a 'Learn More' link, and a 'Configure IP Restrictions' link.

Azure CDN



Azure Content Delivery Network

The Azure Content Delivery Network (CDN) is designed to send audio, video, images, and other files faster and more reliably to customers using servers that are closest to the users. This dramatically increases speed and availability, resulting in significant user experience improvements.

[Learn more](#)

Endpoints

Click on your endpoint below to manage CDN and configure different features.

| HOSTNAME | STATUS |
|----------------------------------|---------|
| handsonazurewebapp.azureedge.net | Running |

[Migrate custom domains to CDN](#)

New endpoint

CDN profile ⓘ

Create new Use existing

handsonazure-cdn

* CDN endpoint name

handsonazurewebapp2.azureedge.net

Origin hostname ⓘ

handsonazure-euw-appservice.azurewebsites.net

Create

Microsoft Azure

Your App Service app is up and running

Go to your app's [Quick Start](#) guide in the Azure portal to get started or read our [deployment documentation](#).

We would love to meet you! The App Service team will be present at the following upcoming events:

| Name | Location | Dates | Info |
|------|----------|-------|------|
|------|----------|-------|------|

```
<!doctype html>
<html>
  <head>
    <meta name="viewport" content="width=device-width, initial-scale=1">
    <meta http-equiv="Content-Type" content="text/html; charset=UTF-8;IE=edge">
    <title>Microsoft Azure App Service - Welcome</title>
    <link rel="shortcut icon" href="https://appservice.azureedge.net/images/favicon.ico" type="image/...
    <style type="text/css">...</style>
    <script type="text/javascript">...</script>
    <link rel="stylesheet" type="text/css" href="https://appservice.azureedge.net/css/main.min.css">
  </head>
  <body>...</body>
</html>
```

Chapter 20: Distributing Load with Azure Traffic Manager

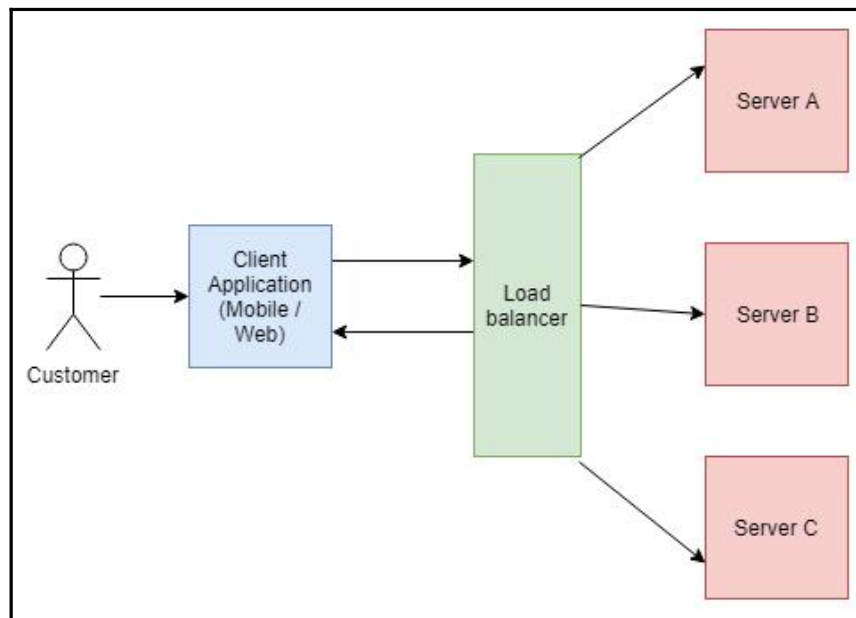
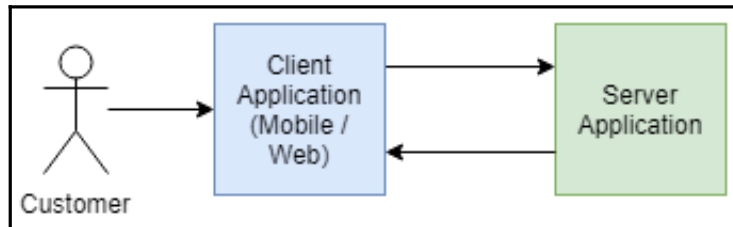

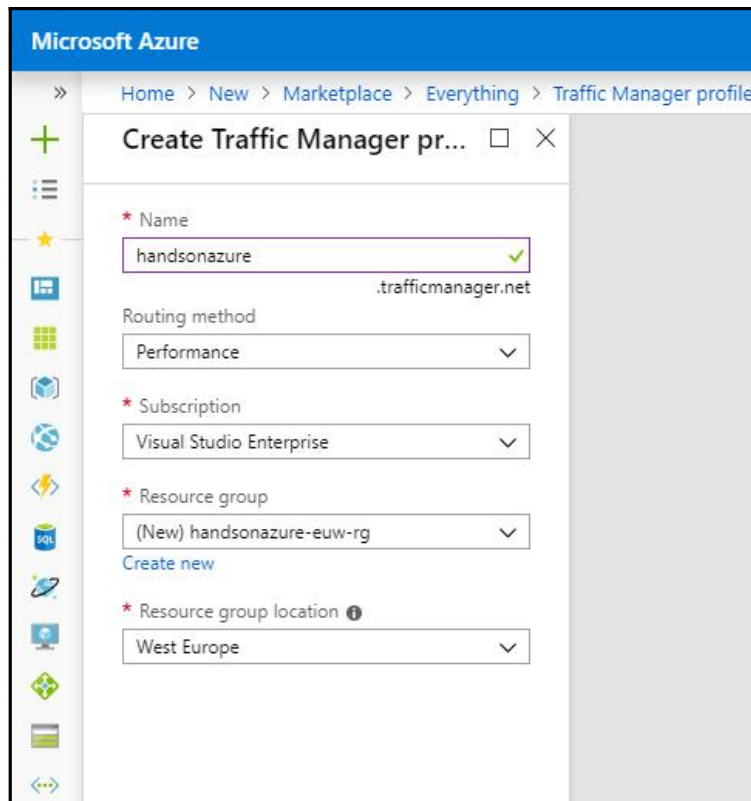
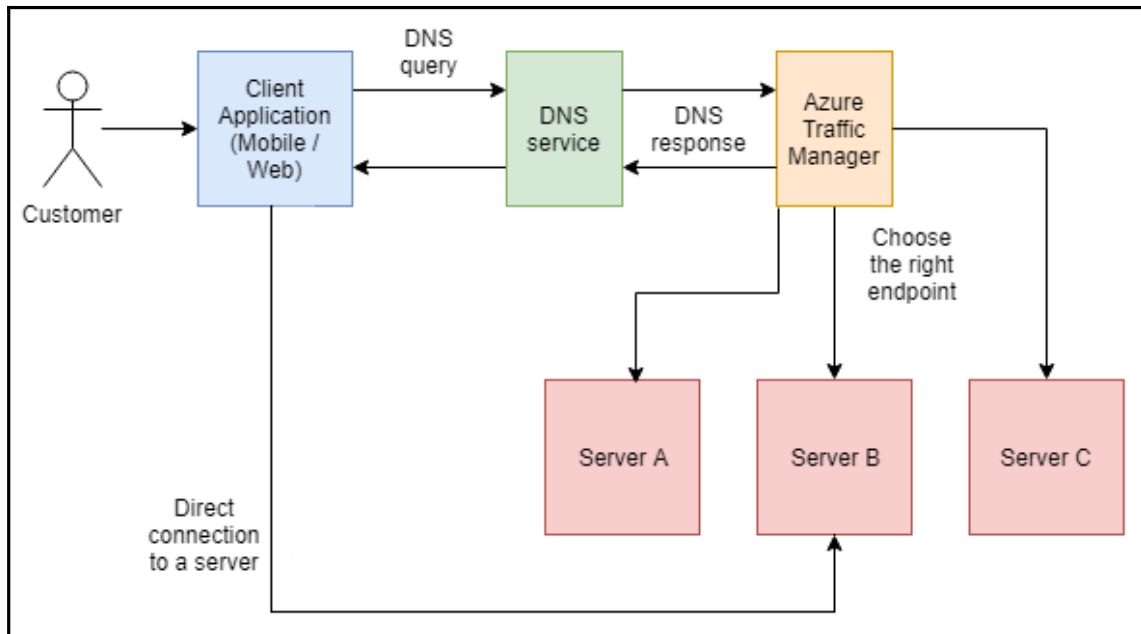

Home > Resource groups > handsonazure-euw-rg > handsonazure

handsonazure
Traffic Manager profile

Search (Ctrl+/) <<

[Enable profile](#)
[Disable profile](#)
[Refresh](#)
[Move](#)
[Delete profile](#)

Resource group [\(change\)](#)
 handsonazure-euw-rg

Status
Enabled

Subscription [\(change\)](#)
Visual Studio Enterprise

Subscription ID
[REDACTED]

Tags [\(change\)](#)
[Click here to add tags](#)

DNS name
http://handsonazure.trafficmanager.net

Monitor status
Inactive

Routing method
Priority

Search endpoints

| NAME | STATUS | MONITOR STATUS | TYPE |
|-------------|--------|----------------|------|
| No results. | | | |

Home > Resource groups > handsonazure-euw-rg > handsonazure - Configuration

handsonazure - Configuration

Traffic Manager profile

Search (Ctrl+/)

- Overview
- Activity log
- Access control (IAM)
- Tags
- Diagnose and solve problems

Settings

- Configuration**
- Real user measurements
- Traffic view
- Endpoints
- Properties
- Locks
- Automation script

Monitoring

- Alerts
- Metrics

Support + troubleshooting

- Resource health
- New support request

Save Discard

Routing method ⓘ

Priority

* DNS time to live (TTL) ⓘ

60

Endpoint monitor settings ⓘ

Protocol

HTTP

* Port

80

* Path

/

Custom Header settings ⓘ

Expected Status Code Ranges (default: 200) ⓘ

Fast endpoint failover settings

Probing interval ⓘ

30

* Tolerated number of failures ⓘ

3

* Probe timeout ⓘ

10

* Path

/status

Expected Status Code Ranges (default: 200) ⓘ

200-204

Home > Resource groups > handsonazure-euw-rg > handsonazure - Real user measurements

handsonazure - Real user measurements

Traffic Manager profile

Search (Ctrl+/) <<



- Overview
- Activity log
- Access control (IAM)
- Tags
- Diagnose and solve problems

Settings

- Configuration
- Real user measurements

Generate a key and embed the provided code in your web property to send network latency collection. The key and provided code apply to all Traffic Manager profiles in the current sub

Key

ce3c1f9a75065b78ba2bff261fba3250   

Measurement JavaScript

```
<script src="http://www.atmrum.net/rum.js"></script>  
<script>rum.start("ce3c1f9a75065b78ba2bff261fba3250");</script>
```



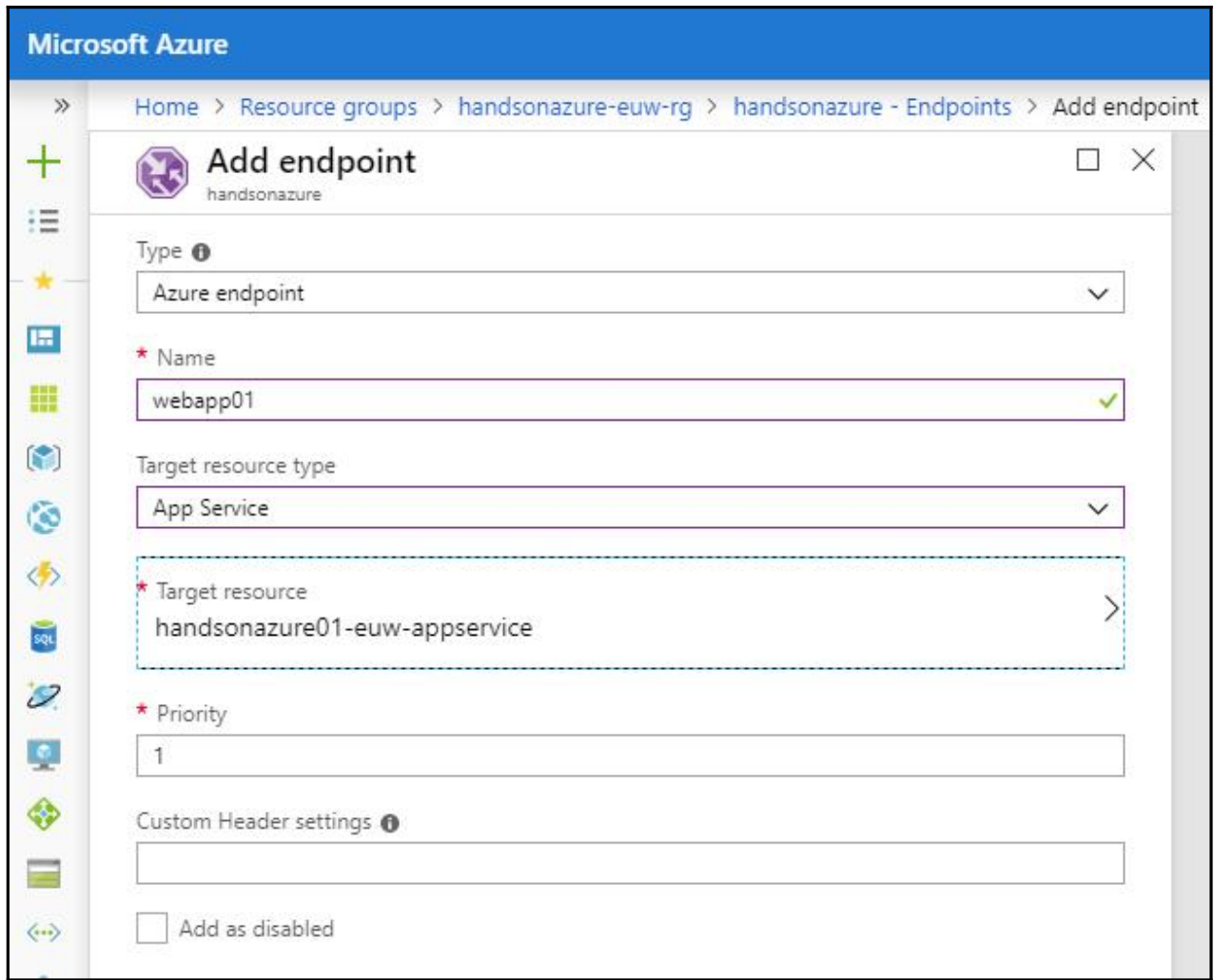

Home > Resource groups > handsonazure-euw-rg > handsonazure - Endpoints

handsonazure - Endpoints

Traffic Manager profile

Search (Ctrl+/) « + Add Refresh

Search endpoints

| NAME | STATUS | MONITOR STATUS | TYPE | PRIORITY |
|----------|---------|-------------------|----------------|----------|
| webapp01 | Enabled | Checking endpoint | Azure endpoint | 1 |
| webapp02 | Enabled | Checking endpoint | Azure endpoint | 2 |

- Overview
- Activity log
- Access control (IAM)
- Tags
- Diagnose and solve problems
- Settings
 - Configuration
 - Real user measurements
 - Traffic view
 - Endpoints

Home > Resource groups > handsonazure-euw-rg > handsonazure - Endpoints

handsonazure - Endpoints

Traffic Manager profile

Search (Ctrl+/) « + Add Refresh

Search endpoints

| NAME | STATUS | MONITOR STATUS | TYPE | PRIORITY |
|----------|---------|----------------|----------------|----------|
| webapp01 | Enabled | Degraded | Azure endpoint | 1 |
| webapp02 | Enabled | Degraded | Azure endpoint | 2 |

- Overview
- Activity log
- Access control (IAM)
- Tags
- Diagnose and solve problems
- Settings
 - Configuration
 - Real user measurements
 - Traffic view
 - Endpoints
 - Properties

Home > Resource groups > handsonazure-euw-rg > handsonazure - Endpoints

handsonazure - Endpoints

Traffic Manager profile

Search (Ctrl+/) << + Add Refresh

Search endpoints

| NAME | STATUS | MONITOR STATUS | TYPE | PRIORITY |
|----------|---------|----------------|----------------|----------|
| webapp01 | Enabled | Online | Azure endpoint | 1 |
| webapp02 | Enabled | Degraded | Azure endpoint | 2 |

Overview
Activity log
Access control (IAM)
Tags
Diagnose and solve problems

Settings

- Configuration
- Real user measurements
- Traffic view
- Endpoints

Home > Resource groups > handsonazure-euw-rg > handsonazure - Traffic view

handsonazure - Traffic view

Traffic Manager profile

Search (Ctrl+/) << Learn more Download Refresh Show heatmap Disable Traffic view

The requested heat map content does not exist. This could be because the given profile has not received any queries in the previous 7 days. If any query was

| DNS QUERY SOURCE IP | ENDPOINT | ENDPOINT LOCATION |
|---------------------|----------|-------------------|
| No results | | |

Overview
Activity log
Access control (IAM)
Tags
Diagnose and solve problems

Settings

- Configuration
- Real user measurements
- Traffic view

Chapter 21: Tips and Tricks for Azure

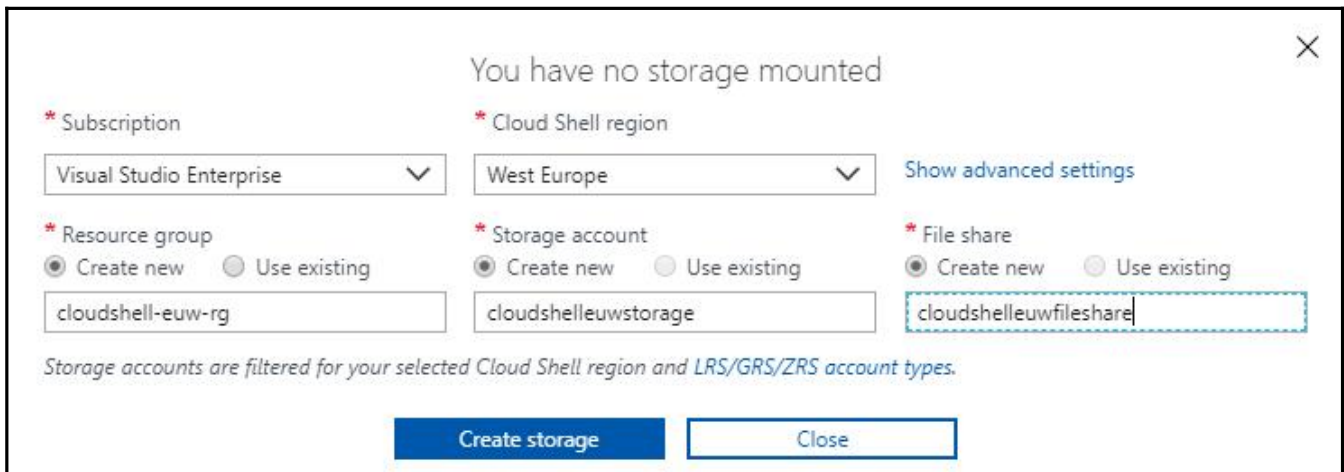
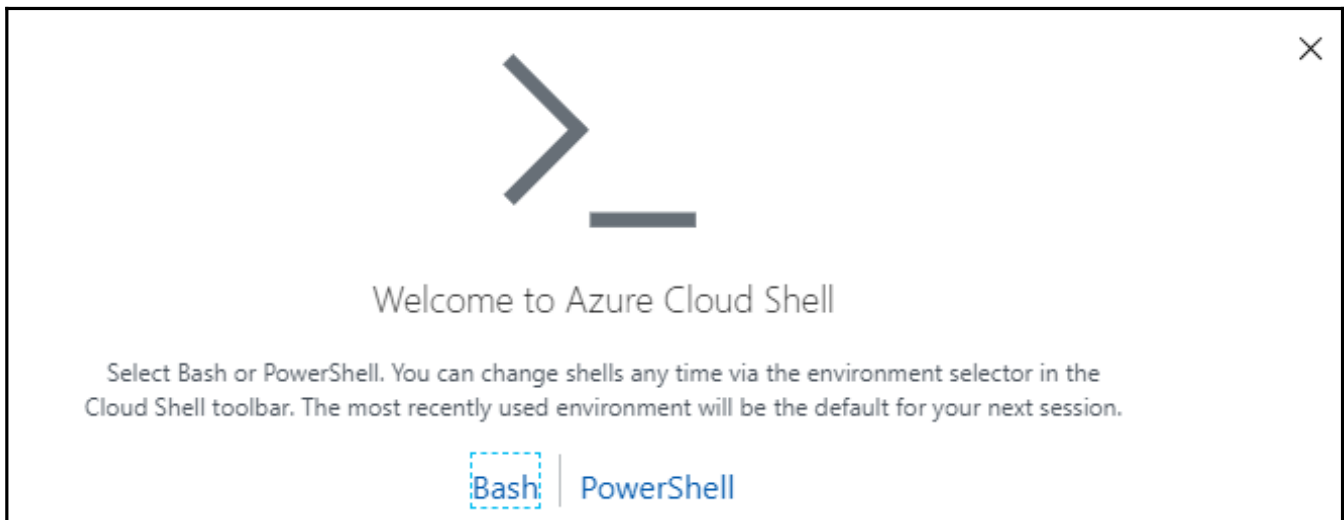
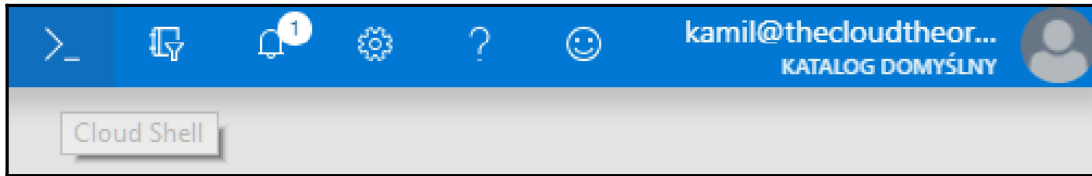

```
PowerShell | ? | ? | ? | ? | ? | ?
Azure:/Visual Studio Enterprise/StorageAccounts/cloudshelleuwstorage/files
PS Azure:\> az
Welcome to Azure CLI!
-----
Use `az -h` to see available commands or go to https://aka.ms/cli.

Telemetry
-----
The Azure CLI collects usage data in order to improve your experience.
The data is anonymous and does not include commandline argument values.
The data is collected by Microsoft.

You can change your telemetry settings with `az configure`.



Welcome to the cool new Azure CLI!

Use `az --version` to display the current version.
Here are the base commands:

account      : Manage Azure subscription information.
acr          : Manage private registries with Azure Container Registries.
acs          : Manage Azure Container Services.
ad           : Manage Azure Active Directory Graph entities needed for Role Based Access Control.
```

handsonazure-euw-rg - Locks
Resource group

Search (Ctrl+/) << + Add Subscription Refresh

- Overview
- Activity log
- Access control (IAM)
- Tags
- Events
- Settings
- Quickstart
- Resource costs
- Deployments
- Policies
- Properties
- Locks**
- Automation script

| LOCK NAME | LOCK TYPE |
|-----------------------------|-----------|
| This resource has no locks. | |

handsonazure-euw-rg - Locks
Resource group

Search (Ctrl+/) << + Add Subscription Refresh

Add lock

Lock name: Delete ✓ Lock type: Delete ▼

Notes: Prevent deleting the RG

OK Cancel

Notifications

More events in the activity log → Dismiss all ...

! Delete resource group handsonazure-euw-rg failed

The resource group handsonazure-euw-rg is locked and can't be deleted. Click here to manage locks for this resource group.

by me a few seconds ago

Home > Resource groups > handsonazure-euw-rg > Everything > Storage account - blob, data lake gen 2 (preview), file, table, queue >

Create storage account

Basics **Advanced** Tags Review + create

Azure Storage is a Microsoft-managed service providing cloud storage that is highly available, secure, durable, scalable, and redundant. Azure Storage includes Azure Blobs (objects), Azure Data Lake Storage Gen2, Azure Files, Azure Queues, and Azure Tables. The cost of your storage account depends on the usage and the options you choose below. [Learn more](#)

PROJECT DETAILS

Select the subscription to manage deployed resources and costs. Use resource groups like folders to organize and manage all your resources.

* Subscription

* Resource group

[Create new](#)
The selected resource group is read only

The notification window is titled "Notifications" and is located in the top right corner of the Azure portal. It contains a link "More events in the activity log" and a "Dismiss all" button. The main notification is a red error message: "Failed to update storage account". The error text reads: "Failed to update storage account 'handsonazureeuwstorage'. Error: The scope '/subscriptions/366cc83feb46/resourceGroups/handsonazure-euw-rg/providers/Microsoft.Storage/storageAccounts/handsonazureeuwstorage' cannot perform write operation because following scope(s) are locked: '/subscriptions/366cc83feb46/resourceGroups/handsonazure-euw-rg/providers/Microsoft.Storage/storageAccounts/handsonazureeuwstorage'...". The notification is attributed to "by me" and occurred "a minute ago".

The screenshot shows the Azure Resource Explorer interface in a browser window. The address bar shows "https://resources.azure.com". The page title is "Azure Resource Explorer (Preview)". The search bar contains "Katalog domy?lny (kamilthecloudtheory.onmicrosoft.com)". The interface is in "Read Only" mode. The left sidebar shows "providers" and "subscriptions" expanded. The main content area shows a REST API endpoint with a JSON response. The response is:

```
1 {  
2   "message": "Select a node to start"  
3 }
```

Azure Resource Explorer (Preview) Search Katalog domy?Iny (kamilthecloudtheory.onmicrosoft.com) Read Only

providers

- + Microsoft.Capacity
- Microsoft.DocumentDB
 - + databaseAccountNames
 - operations
- Microsoft.Storage
 - operations
- subscriptions
- + Pay-As-You-Go
- Visual Studio Enterprise
 - locations
 - providers
 - resourceGroups
 - + cloudshell-euw-rg
 - handsonazure-euw-rg
 - providers
 - * Show all
 - + Microsoft.Resources
 - Microsoft.Storage
 - storageAccounts
 - handsonazureeuw
 - resources
 - + sf-euw-rg
 - resources
 - + tagNames

Data (GET, PUT) Actions (POST, DELETE) Create Documentation PowerShell Ansible

GET Edit <https://management.azure.com/subscriptions/...>

```
1 {
2   "sku": {
3     "name": "Standard_LRS",
4     "tier": "Standard"
5   },
6   "kind": "Storage",
7   "id": "/subscriptions/.../resourceGroups/handsonazure
8   "name": "handsonazureeuwstorage",
9   "type": "Microsoft.Storage/storageAccounts",
10  "location": "westeurope",
11  "tags": {},
12  "properties": {
13    "networkAcls": {
14      "bypass": "AzureServices",
15      "virtualNetworkRules": [],
16      "ipRules": [],
17      "defaultAction": "Allow"
18    },
19    "supportsHttpsTrafficOnly": true,
20    "encryption": {
21      "services": {
22        "file": {
23          "enabled": true,
24          "lastEnabledTime": "2018-10-27T15:48:19.7529567Z"
25        },
26        "blob": {
27          "enabled": true,
28          "lastEnabledTime": "2018-10-27T15:48:19.7529567Z"
29        }
30      },
31      "keySource": "Microsoft.Storage"
32    },
33    "provisioningState": "Succeeded",
34    "creationTime": "2018-10-27T15:48:19.6123426Z",
35    "primaryEndpoints": {
36      "blob": "https://handsonazureeuwstorage.blob.core.windows.net/",
37      "queue": "https://handsonazureeuwstorage.queue.core.windows.net/",
38      "table": "https://handsonazureeuwstorage.table.core.windows.net/",
```