

Chapter 2: Introduction to Blockchain Programming

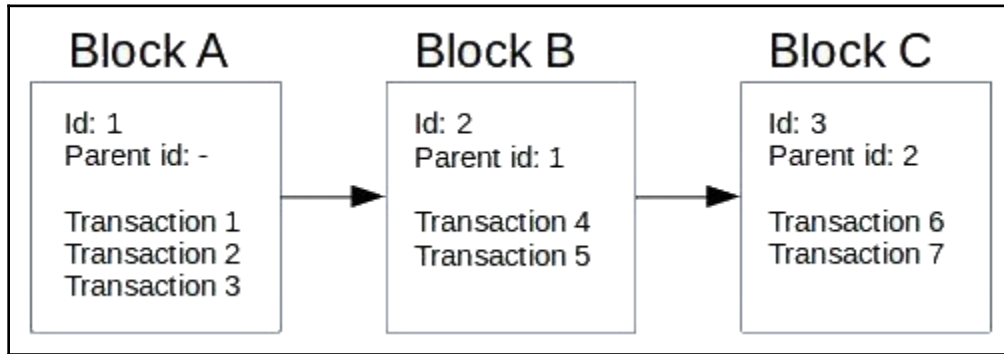

```

Traceback (most recent call last):
  File "falsify_message.py", line 20, in <module>
    hashes.SHA256())
  File "/opt/code/blockchain/blockchain_venv/lib/python3.6/site-packages/cryptography/hazmat/backends/openssl/rsa.py", line 474, in verify
    self._backend.padding, algorithm, self, signature, data
  File "/opt/code/blockchain/blockchain_venv/lib/python3.6/site-packages/cryptography/hazmat/backends/openssl/rsa.py", line 268, in _rsa_sig_verify
    raise InvalidSignature
cryptography.exceptions.InvalidSignature
  
```

```

b' /zD\x07A[1\x86K\xd0\xba\x1d\xba\xbc3\xd0\xf5"q\xedJ\xda\xf3\x1b\xc8\xcf\xb4\xbc\xa04\xa7_k\xa9\xc5\x90\x98\xaf\xc000\x06J<\xe1\xdc5p8a\x83\xfc1\xae2\x80\xcd\xb3\x8d\x0b\xfe5\x12\xf0%\xcev,\x85\xe3>\xf8\xbd\xbe\xce\x12\xabr\x99\xfa\x14t\xd7\xfej\x0c\xb0\x9e)B\x1cEj\x01\x92 \x99\xbb\xfa4'K\x96r\\ \x91@zN\x04\xdf\x00}\x1fa\xa3?X\xd8\x11pX\xdd\xcd'
  
```

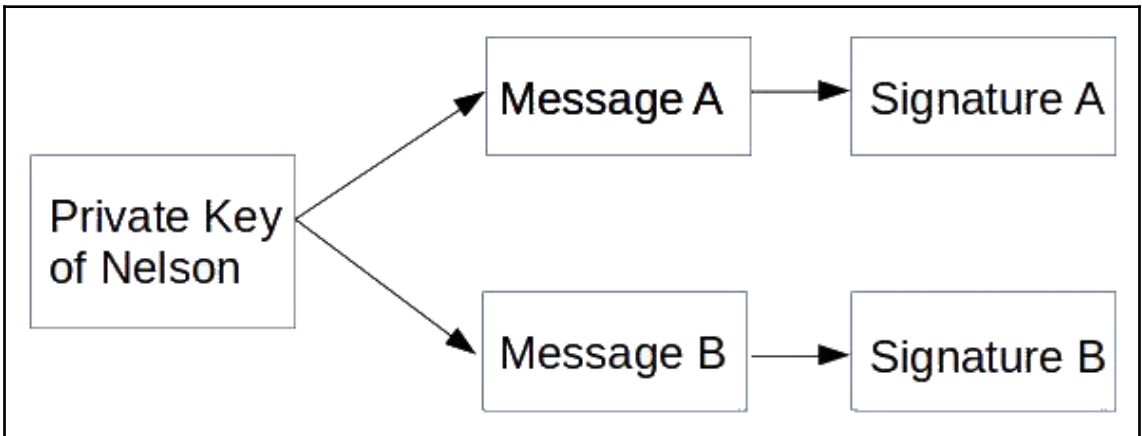

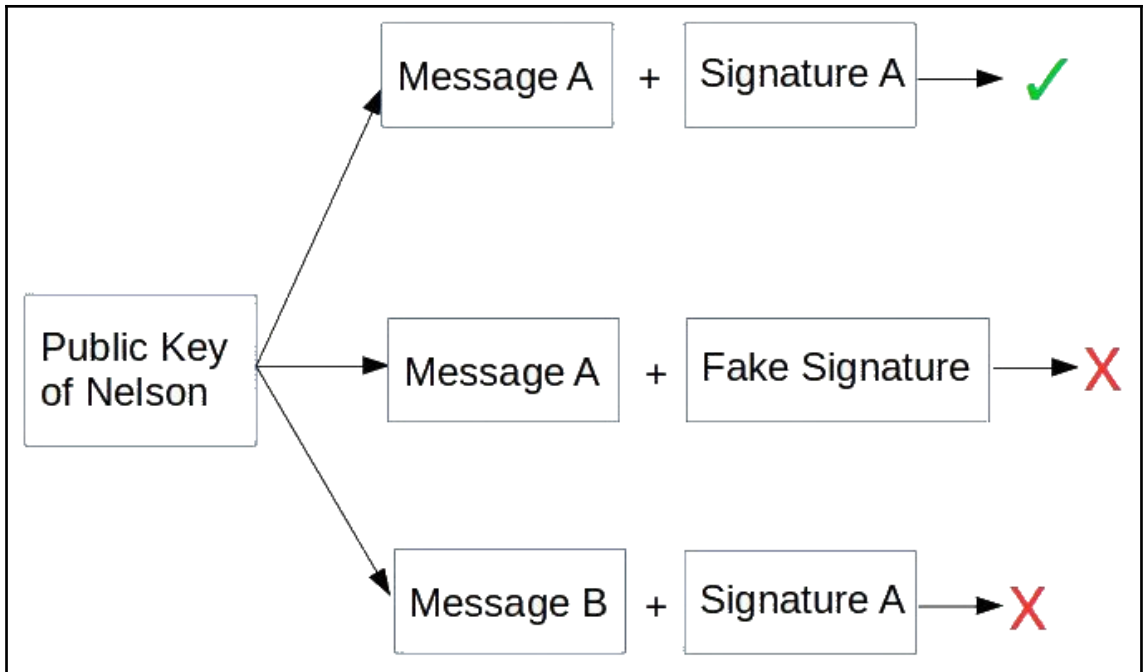

West side

Id: 5

History: "Sherly likes fish"

Id: 5

History: "Johnny likes shrimp"

East side

West side

Id: 5
History: "Sherly likes fish"

Id: 7
History: "Sarah loves dog"

Id: 6
History: "Marie hates shark"

Id: 5
History: "Johny likes shrimp"

East side

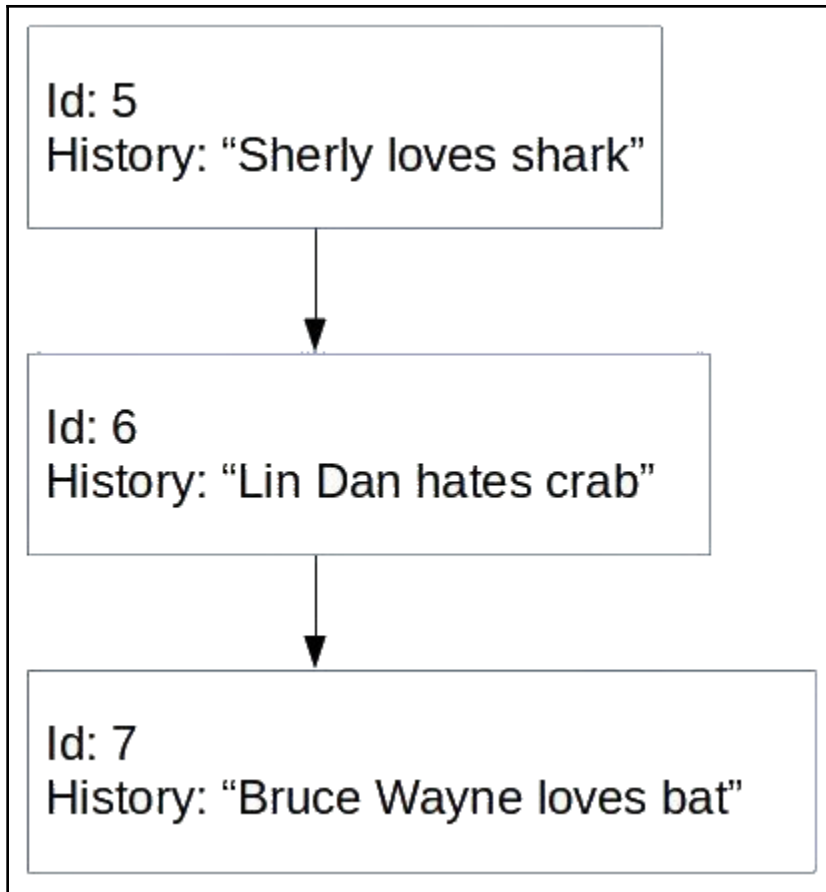

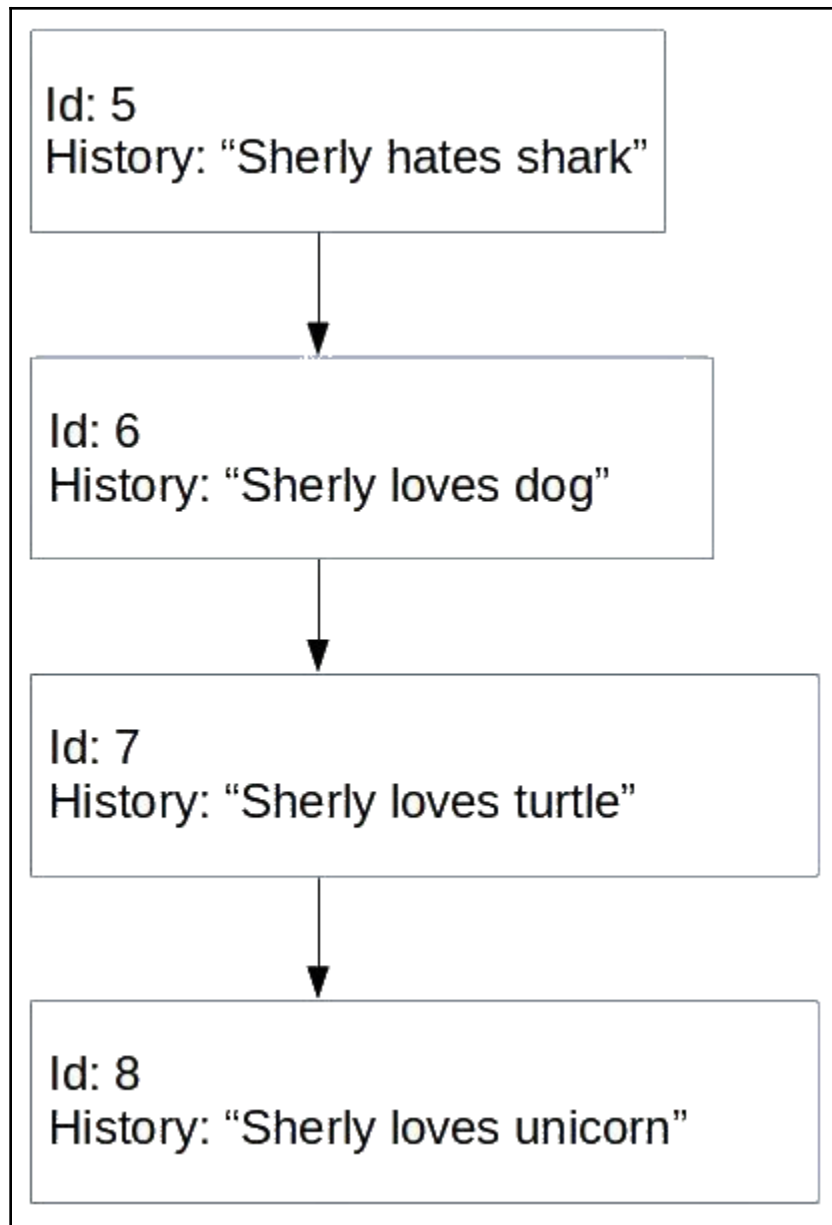

Chapter 3: Smart Contract Fundamentals

- ✓ Preparing to download
- ✓ Downloading
- ✓ Cleaning up temporary files
- ✓ Setting up box

Unbox successful. Sweet!

Commands:

```
Compile:      truffle compile
Migrate:      truffle migrate
Test contracts: truffle test
```

```
Compiling ./contracts/Migrations.sol...
Compiling ./contracts/donation.sol...
Writing artifacts to ./build/contracts
```

Ganache

ACCOUNTS BLOCKS TRANSACTIONS LOGS SEARCH FOR BLOCK NUMBERS OR TX HASHES

CURRENT BLOCK: 0 GAS PRICE: 2000000000 GAS LIMIT: 6721975 NETWORK ID: 5777 RPC SERVER: HTTP://127.0.0.1:7545 MINING STATUS: AUTOMINING

MNEMONIC ? family ozone copper nice leg try tail stumble mention confirm liar critic **HD PATH** m/44'/60'/0'/0'/account_index

ADDRESS	BALANCE	TX COUNT	INDEX	
0xb105F01Ce341Ef9282dc2201BDfdA2c26903da77	100.00 ETH	0	0	
0x6d3eBC3000d112B70aaCA8F770B06f961C852014	100.00 ETH	0	1	
0x9049386D4d5808e0Cd9e294F2aA3d70F01Fbf0C5	100.00 ETH	0	2	
0x393fc3aD526e48418f1A0b6491894FA23392cd36	100.00 ETH	0	3	
0x3d3f47Af52F8ff37bDECCFdC2B6402d52FFea314	100.00 ETH	0	4	
0x6D578BDeAE84A710f4E7a85608848e9fE9eC7B3F	100.00 ETH	0	5	
0x3702ff226DA6918428F9E016b5CB5760f43eD3F5	100.00 ETH	0	6	
0xD9E1fB0D45427F20E37e9EF25CF2C6de685dE359	100.00 ETH	0	7	
0x19C0a3FAEeB52A1EcfADa65Ef882364BB4c443b5	100.00 ETH	0	8	

⚠ Important ⚠
If you're using an HDWalletProvider, it must be Web3 1.0 enabled or your migration will hang.

Starting migrations...

```
=====
> Network name:   'development'
> Network id:    5777
> Block gas limit: 6721975
```

1_initial_migration.js

```
=====
Deploying 'Migrations'
-----
> transaction hash: 0xc265c6afb14e3a5d409d7bf66ed3d3f8fe4654d04ef55d854190daacdc943e03
> Blocks: 0        Seconds: 0
> contract address: 0x9Dc44aa8d05c86388E647F954D00CaA858837804
> account:          0xb105F01Ce341Ef9282dc2201BDfdA2c26903da77
> balance:          99.99430184
> gas used:         284908
> gas price:        20 gwei
> value sent:       0 ETH
> total cost:       0.00569816 ETH

> Saving migration to chain.
> Saving artifacts
-----
> Total cost:       0.00569816 ETH
```

2_deploy_donation.js

```
=====
Deploying 'Donation'
-----
> transaction hash: 0xfdc69335e7cf2974529d298202fd2ecbce8f4756f444de2cc20fff898f3fef18
> Blocks: 0        Seconds: 0
> contract address: 0x3E9417399786347B6Ab38f59d3f00829d6bba7b8
> account:          0xb105F01Ce341Ef9282dc2201BDfdA2c26903da77
> balance:          99.98444338
> gas used:         450889
> gas price:        20 gwei
> value sent:       0 ETH
> total cost:       0.00901778 ETH

> Saving migration to chain.
> Saving artifacts
-----
> Total cost:       0.00901778 ETH
```

Summary

```
=====
> Total deployments: 2
> Final cost:       0.01471594 ETH
```

Ganache

ACCOUNTS BLOCKS TRANSACTIONS LOGS

SEARCH FOR BLOCK NUMBERS OR TX HASHES

CURRENT BLOCK: 4 | GAS PRICE: 200000000 | GAS LIMIT: 6721975 | NETWORK ID: 5777 | RPC SERVER: HTTP://127.0.0.1:7545 | MINING STATUS: AUTOMINING

MNEMONIC family ozone copper nice leg try tail stumble mention confirm liar critic | **HD PATH** m/44'/60'/0'/0/account_index

ADDRESS	BALANCE	TX COUNT	INDEX
0xb105F01Ce341Ef9282dc2201BDfdA2c26903da77	99.92 ETH	4	0
0x6d3eBC3000d112B70aaCA8F770B06f961C852014	100.00 ETH	0	1
0x9049386D4d5808e0Cd9e294F2aA3d70F01Fbf0C5	100.00 ETH	0	2
0x393fc3aD526e48418f1A0b6491894FA23392cd36	100.00 ETH	0	3
0x3d3f47Af52F8ff37bDECCFdC2B6402d52FFea314	100.00 ETH	0	4
0x6D578BDeAE84A710f4E7a85608848e9fE9eC7B3F	100.00 ETH	0	5
0x3702ff226DA6918428F9E016b5CB5760f43eD3F5	100.00 ETH	0	6

Ganache

ACCOUNTS BLOCKS TRANSACTIONS LOGS

SEARCH FOR BLOCK NUMBERS OR TX HASHES

CURRENT BLOCK: 4 | GAS PRICE: 200000000 | GAS LIMIT: 6721975 | NETWORK ID: 5777 | RPC SERVER: HTTP://127.0.0.1:7545 | MINING STATUS: AUTOMINING

TX HASH 0x6e60da3f898f824a81c91b687662c8a379b375d5601f492f6fa53de208bee3f5	CONTRACT CALL		
FROM ADDRESS 0xb105F01Ce341Ef9282dc2201BDfdA2c26903da77	TO CONTRACT ADDRESS 0x9Dc44aa8d05c86388E647F954D00CaA858837804	GAS USED 27008	VALUE 0
TX HASH 0xdbefe42a05c993a4c13310a7a14672213547950663ea4d26322dcff3f3b5e883	CONTRACT CREATION		
FROM ADDRESS 0xb105F01Ce341Ef9282dc2201BDfdA2c26903da77	CREATED CONTRACT ADDRESS 0x3E941739978634786Ab38F59d3f00829d6bba7b8	GAS USED 462459	VALUE 0
TX HASH 0x16285e95cb7a3dd5c17a3e9c518482ca90df44690b1694aae5a723cfd62bdfc	CONTRACT CALL		
FROM ADDRESS 0xb105F01Ce341Ef9282dc2201BDfdA2c26903da77	TO CONTRACT ADDRESS 0x9Dc44aa8d05c86388E647F954D00CaA858837804	GAS USED 42008	VALUE 0
TX HASH 0x7512934e34b9e6dbb5384b82e90720222d9a46b4ff5ac5a5c91ff64a21ae6fd	CONTRACT CREATION		
FROM ADDRESS 0xb105F01Ce341Ef9282dc2201BDfdA2c26903da77	CREATED CONTRACT ADDRESS 0x9Dc44aa8d05c86388E647F954D00CaA858837804	GAS USED 277462	VALUE 0

```
truffle(development)> Donation.deployed().then(function(instance) { return instance.change_useless_variab
e("sky is blue", {from: "0xb105F01ce341Ef9282dc2201BDfda2c26903da77" }); });
{ tx:
  '0xbbbbfc848999907c55c5ae5f5e7e0f4c8f73316bfc66170f018a5bf52a6d1b6',
  receipt:
    { transactionHash:
      '0xbbbbfc848999907c55c5ae5f5e7e0f4c8f73316bfc66170f018a5bf52a6d1b6',
      transactionIndex: 0,
      blockHash:
        '0x31875d328acfa552bfe8705cf930037c0061bba5770ce38d3ae5eecad2b33118',
      blockNumber: 5,
      from: '0xb105f01ce341ef9282dc2201bdfda2c26903da77',
      to: '0x3e9417399786347b6ab38f59d3f00829d6bba7b8',
      gasUsed: 33684,
      cumulativeGasUsed: 33684,
      contractAddress: null,
      logs: [],
      status: true,
      logsBloom:
        '0x000000000000000000000000000000000000000000000000000000000000000000000000000000000000000
000000000000000000000000000000000000000000000000000000000000000000000000000000000000000000000
000000000000000000000000000000000000000000000000000000000000000000000000000000000000000000000
000000000000000000000000000000000000000000000000000000000000000000000000000000000000000000000
000000000000000000000000000000000000000000000000000000000000000000000000000000000000000000000',
      v: '0x1c',
      r:
        '0xe8a28af0553506b18c860a46e970fec181a3d1d6a784362cd28c814a72f04f45',
      s:
        '0x7b3406452158e26078a066ee859281127536984620d7d080076857b904d853f3',
      rawLogs: [] },
  logs: [] }
```

Ganache

ACCOUNTS BLOCKS TRANSACTIONS LOGS

SEARCH FOR BLOCK NUMBERS OR TX HASHES

CURRENT BLOCK: 5 GAS PRICE: 200000000 GAS LIMIT: 6721975 NETWORK ID: 5777 RPC SERVER: HTTP://127.0.0.1:7545 MINING STATUS: AUTOMINING

MNEMONIC family ozone copper nice leg try tail stumble mention confirm liar critic **HD PATH** m/44'/60'/0'/0/account_index

ADDRESS	BALANCE	TX COUNT	INDEX	
0xb105F01Ce341Ef9282dc2201BDfdA2c26903da77	99.92 ETH	5	0	
0x6d3eBC3000d112B70aaCA8F770B06f961C852014	100.00 ETH	0	1	
0x9049386D4d5808e0Cd9e294F2aA3d70F01Fbf0C5	100.00 ETH	0	2	
0x393fc3aD526e48418f1A0b6491894FA23392cd36	100.00 ETH	0	3	
0x3d3f47Af52F8ff37bDECCFdC2B6402d52FFea314	100.00 ETH	0	4	
0x6D578BDeAE84A710f4E7a85608848e9fE9eC7B3F	100.00 ETH	0	5	
0x3702ff226DA6918428F9E016b5CB5760f43eD3F5	100.00 ETH	0	6	

Ganache

ACCOUNTS BLOCKS TRANSACTIONS LOGS SEARCH FOR BLOCK NUMBERS OR TX HASHES

CURRENT BLOCK: 6 GAS PRICE: 2000000000 GAS LIMIT: 6721975 NETWORK ID: 5777 RPC SERVER: HTTP://127.0.0.1:7545 MINING STATUS: AUTOMINING

MNEMONIC family ozone copper nice leg try tail stumble mention confirm liar critic **HD PATH** m/44'/60'/0'/0/account_index

ADDRESS	BALANCE	TX COUNT	INDEX	
0xb105F01Ce341Ef9282dc2201BDfdA2c26903da77	99.98 ETH	5	0	
0x6d3eBC3000d112B70aaCA8F770B06f961C852014	95.00 ETH	1	1	
0x9049386D4d5808e0Cd9e294F2aA3d70F01Fbf0C5	100.00 ETH	0	2	
0x393fc3aD526e48418f1A0b6491894FA23392cd36	100.00 ETH	0	3	
0x3d3f47Af52F8ff37bDECCFdC2B6402d52FFea314	100.00 ETH	0	4	
0x6D578BDeAE84A710f4E7a85608848e9fE9eC7B3F	100.00 ETH	0	5	
0x3702ff226DA6918428F9E016b5CB5760f43eD3F5	100.00 ETH	0	6	

Ganache

ACCOUNTS BLOCKS TRANSACTIONS LOGS SEARCH FOR BLOCK NUMBERS OR TX HASHES

CURRENT BLOCK: 7 GAS PRICE: 20000000000 GAS LIMIT: 6721975 NETWORK ID: 5777 RPC SERVER: HTTP://127.0.0.1:7545 MINING STATUS: AUTOMINING

MNEMONIC family ozone copper nice leg try tail stumble mention confirm liar critic **HD PATH** m/44'/60'/0'/0/account_index

ADDRESS	BALANCE	TX COUNT	INDEX
0xb105F01Ce341Ef9282dc2201BDfdA2c26903da77	104.98 ETH	6	0
0x6d3eBC3000d112B70aaCA8F770B06f961C852014	95.00 ETH	1	1
0x9049386D4d5808e0Cd9e294F2aA3d70F01Fbf0C5	100.00 ETH	0	2
0x393fc3aD526e48418f1A0b6491894FA23392cd36	100.00 ETH	0	3
0x3d3f47Af52F8ff37bDECCFdC2B6402d52FFea314	100.00 ETH	0	4
0x6D578BDeAE84A710f4E7a85608848e9fE9eC7B3F	100.00 ETH	0	5
0x3702ff226DA6918428F9E016b5CB5760f43eD3F5	100.00 ETH	0	6

```

Compiling ./contracts/Migrations.sol...
Writing artifacts to ./build/contracts

⚠ Important ⚠
If you're using an HDWalletProvider, it must be Web3 1.0 enabled or your migration will hang.

Starting migrations...
=====
> Network name:      'development'
> Network id:       5777
> Block gas limit:  6721975

1_initial_migration.js
=====

  Deploying 'Migrations'
  -----
  > transaction hash: 0x707a30979acaa7a3900f14b9dc611e20c2faf8a64d1abd82e0898a51d99e302e
  > Blocks: 0        Seconds: 0
  > contract address: 0x9Dc44aa8d05c86388E647F954D00CaA858837804
  > account:         0xb105F01Ce341Ef9282dc2201BDfdA2c26903da77
  > balance:         99.99430184
  > gas used:        284908
  > gas price:       20 gwei
  > value sent:      0 ETH
  > total cost:      0.00569816 ETH

  > Saving migration to chain.
  > Saving artifacts
  -----
  > Total cost:      0.00569816 ETH

2_deploy_hello.js
=====

  Deploying 'Contract'
  -----
  > transaction hash: 0xf410b462cf3786dbbef3e37397d697263663558300a43e824cc8fcac144294c1
  > Blocks: 0        Seconds: 0
  > contract address: 0x3E9417399786347B6Ab38f59d3f00829d6bba7b8
  > account:         0xb105F01Ce341Ef9282dc2201BDfdA2c26903da77
  > balance:         99.9866772
  > gas used:        339198
  > gas price:       20 gwei
  > value sent:      0 ETH
  > total cost:      0.00678396 ETH

  > Saving migration to chain.
  > Saving artifacts
  -----
  > Total cost:      0.00678396 ETH

Summary
=====
> Total deployments: 2
> Final cost:       0.01248212 ETH

```

```

truffle(development)> Contract.at("0x3E9417399786347B6Ab38f59d3f00829d6bba7b8")
TruffleContract {
  constructor:
    { [Function: TruffleContract]
      _constructorMethods:
        { setProvider: [Function: setProvider],
          new: [Function: new],
          at: [Function: at],
          deployed: [Function: deployed],
          defaults: [Function: defaults],
          hasNetwork: [Function: hasNetwork],
          isDeployed: [Function: isDeployed],
          detectNetwork: [Function: detectNetwork],
          setNetwork: [Function: setNetwork],
          setWallet: [Function: setWallet],
          resetAddress: [Function: resetAddress],
          link: [Function: link],
          clone: [Function: clone],
          addProp: [Function: addProp],
          toJSON: [Function: toJSON],
          decodeLogs: [Function: decodeLogs] },
      _properties:
        { contract_name: [Object],
          contractName: [Object],
          gasMultiplier: [Object],
          timeoutBlocks: [Object],
          autoGas: [Object],
          numberFormat: [Object],
          abi: [Object],
          network: [Function: network],
          networks: [Function: networks],
          address: [Object],
          transactionHash: [Object],
          links: [Function: links],
          events: [Function: events],
          binary: [Function: binary],
          deployedBinary: [Function: deployedBinary],
          unlinked_binary: [Object],
          bytecode: [Object],
          deployedBytecode: [Object],
          sourceMap: [Object],
          deployedSourceMap: [Object],
          source: [Object],
          sourcePath: [Object],
          legacyAST: [Object],
          ast: [Object],
          compiler: [Object],
          schema_version: [Function: schema_version],
          schemaVersion: [Function: schemaVersion],
          updated_at: [Function: updated_at],
          updatedAt: [Function: updatedAt],
          userdoc: [Function: userdoc],
          devdoc: [Function: devdoc] },
      _property_values: {},
      _json:
        { contractName: undefined,
          abi: [Array],
          bytecode:

```

Ganache

ACCOUNTS BLOCKS TRANSACTIONS LOGS

SEARCH FOR BLOCK NUMBERS OR TX HASHES

CURRENT BLOCK: 0 | GAS PRICE: 2000000000 | GAS LIMIT: 6721975 | NETWORK ID: 5777 | RPC SERVER: HTTP://127.0.0.1:7545 | MINING STATUS: AUTOMINING

MNEMONIC family ozone copper nice leg try tail stumble mention confirm liar critic | **HD PATH** m/44'/60'/0'/0/account_index

ADDRESS	BALANCE	TX COUNT	INDEX
0xb105F01Ce341Ef9282dc2201BDfdA2c26903da77	100.00 ETH	0	0
0x6d3eBC3000d112B70aaCA8F770B06f961C852014	100.00 ETH	0	1
0x9049386D4d5808e0Cd9e294F2aA3d70F01Fbf0C5	100.00 ETH	0	2
0x393fc3aD526e48418f1A0b6491894FA23392cd36	100.00 ETH	0	3
0x3d3f47Af52F8ff37bDECCFdC2B6402d52FFea314	100.00 ETH	0	4

Ganache

ACCOUNTS BLOCKS TRANSACTIONS LOGS

SEARCH FOR BLOCK NUMBERS OR TX HASHES

CURRENT BLOCK: 7 | GAS PRICE: 2000000000 | GAS LIMIT: 6721975 | NETWORK ID: 5777 | RPC SERVER: HTTP://127.0.0.1:7545 | MINING STATUS: AUTOMINING

MNEMONIC family ozone copper nice leg try tail stumble mention confirm liar critic | **HD PATH** m/44'/60'/0'/0/account_index

ADDRESS	BALANCE	TX COUNT	INDEX
0xb105F01Ce341Ef9282dc2201BDfdA2c26903da77	99.99 ETH	5	0
0x6d3eBC3000d112B70aaCA8F770B06f961C852014	98.00 ETH	1	1
0x9049386D4d5808e0Cd9e294F2aA3d70F01Fbf0C5	96.50 ETH	1	2
0x393fc3aD526e48418f1A0b6491894FA23392cd36	100.00 ETH	0	3
0x3d3f47Af52F8ff37bDECCFdC2B6402d52FFea314	100.00 ETH	0	4

Ganache

ACCOUNTS BLOCKS TRANSACTIONS LOGS

SEARCH FOR BLOCK NUMBERS OR TX HASHES

CURRENT BLOCK 8	GAS PRICE 2000000000	GAS LIMIT 6721975	NETWORK ID 5777	RPC SERVER HTTP://127.0.0.1:7545	MINING STATUS AUTOMINING
--------------------	-------------------------	----------------------	--------------------	-------------------------------------	-----------------------------

MNEMONIC family ozone copper nice leg try tail stumble mention confirm liar critic

HD PATH m/44'/60'/0'/0/account_index

ADDRESS	BALANCE	TX COUNT	INDEX	
0xb105F01Ce341Ef9282dc2201BDfdA2c26903da77	105.48 ETH	6	0	
0x6d3eBC3000d112B70aaCA8F770B06f961C852014	98.00 ETH	1	1	
0x9049386D4d5808e0Cd9e294F2aA3d70F01Fbf0C5	96.50 ETH	1	2	
0x393fc3aD526e48418f1A0b6491894FA23392cd36	100.00 ETH	0	3	
0x3d3f47Af52F8ff37bDECCFdC2B6402d52FFea314	100.00 ETH	0	4	

```
2_deploy_hello.js
```

```
=====
```

```
Replacing 'Hello'
```

```
-----
```

```
> transaction hash: 0x35f141e349184d28bdc2b226a7ed0d5917761224b7c7d1148980501213d43998
> Blocks: 0        Seconds: 0
> contract address: 0xBc932d934cfE859F9Dc903fdd5DE135F32EbC20E
> account:         0xb105F01Ce341Ef9282dc2201BDfdA2c26903da77
> balance:         99.97281372
> gas used:        339198
> gas price:       20 gwei
> value sent:      0 ETH
> total cost:      0.00678396 ETH
```

```
> Saving migration to chain.
```

```
> Saving artifacts
```

```
-----
```

```
> Total cost:      0.00678396 ETH
```

```
3_deploy_donation.js
```

```
=====
```

```
Deploying 'Donation'
```

```
-----
```

```
> transaction hash: 0xb691f88223487b40ffe7fa6588c037e98e4f47669e2d917521092ada4aa63d5d
> Blocks: 0        Seconds: 0
> contract address: 0x98Db4235158831BF9133faC1c4e1829021ecEB67
> account:         0xb105F01Ce341Ef9282dc2201BDfdA2c26903da77
> balance:         99.96359732
> gas used:        433786
> gas price:       20 gwei
> value sent:      0 ETH
> total cost:      0.00867572 ETH
```

```
> Saving migration to chain.
```

```
> Saving artifacts
```

```
-----
```

```
> Total cost:      0.00867572 ETH
```

Chapter 6: Interacting with Smart Contracts Using Web3

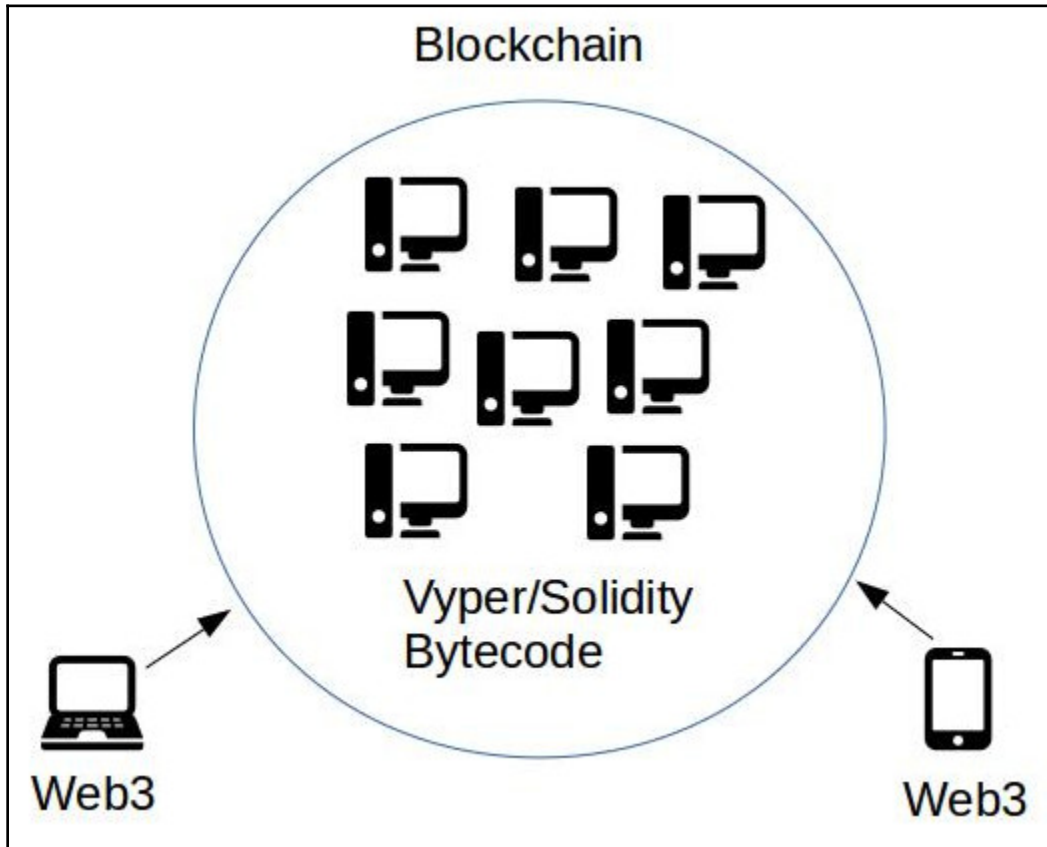

Ganache

ACCOUNTS BLOCKS TRANSACTIONS LOGS

CURRENT BLOCK: 0 GAS PRICE: 20000000000 GAS LIMIT: 4721975 NETWORK ID: 5777 RPC SERVER: HTTP://127.0.0.1:7545 MINING STATUS: AUTOMINING

MNEMONIC: family ozone copper nice leg try tail stumble mention confirm liar critic HD PATH: m/44'/60'/0'/0/account_index

ADDRESS	BALANCE	TX COUNT	INDEX
0xb105F01Ce341Ef9282dc2201BDfdA2c26903da77	100.00 ETH	0	0
0x6d3eBC3000d112B70aaCA8F770B06f961C852014		0	1
0x9049386D4d5808e0Cd9...		0	2
0x393fc3aD526e48418f1...		0	3
0x3d3f47Af52F8ff37bDECCFdC2B6402d52FFea314	100.00 ETH	0	4
0x6D578BDaE84A710f4E7a85608848e9fE9eC7B3F	100.00 ETH	0	5
0x3702ff226DA6918428F9E016b5CB5760f43eD3F5	100.00 ETH	0	6

PRIVATE KEY

59e31694256f71b8d181f47fc67914798c4b96990e835fc1407bf4673ead30e2

DONE

Ganache

ACCOUNTS BLOCKS TRANSACTIONS LOGS SEARCH FOR BLOCK NUMBERS OR TX HASHES

CURRENT BLOCK: 1 GAS PRICE: 2000000000 GAS LIMIT: 6721975 NETWORK ID: 5777 RPC SERVER: HTTP://127.0.0.1:7545 MINING STATUS: AUTOMINING

MNEMONIC family ozone copper nice leg try tail stumble mention confirm liar critic **HD PATH** m/44'/60'/0'/0/account_index

ADDRESS	BALANCE	TX COUNT	INDEX	
0xb105F01Ce341Ef9282dc2201BDfdA2c26903da77	100.00 ETH	0	0	
0x6d3eBC3000d112B70aaCA8F770B06f961C852014	99.00 ETH	1	1	
0x9049386D4d5808e0Cd9e294F2aA3d70F01Fbf0C5	101.00 ETH	0	2	
0x393fc3aD526e48418f1A0b6491894FA23392cd36	100.00 ETH	0	3	
0x3d3f47Af52F8ff37bDECCFdC2B6402d52FFea314	100.00 ETH	0	4	
0x6D578BDeAE84A710f4E7a85608848e9fE9eC7B3F	100.00 ETH	0	5	
0x3702ff226DA6918428F9E016b5CB5760f43eD3F5	100.00 ETH	0	6	

Ganache

ACCOUNTS BLOCKS TRANSACTIONS LOGS

CURRENT BLOCK: 9 GAS PRICE: 20000000000 GAS LIMIT: 8721975 NETWORK ID: 5777 RPC URL: HTTP://127.0.0.1:7545 MINING STATUS: AUTOMINING

MNEMONIC: family ozone copper nice leg try tail stumble mention confirm liar critic HD PATH: m/44'/60'/0'/0/account_index

ADDRESS	BALANCE	TX COUNT	INDEX
0xb105F01Ce341Ef9282dc22018DfdA2c26903da77	100.00 ETH	0	0
0x6d3eBC3000d112B70aa	0x6d3eBC3000d112B70aaCA8F70B06f961C852014	0	1
0x9049386D4d5808e0Cd9	PRIVATE KEY 59e31694256f71b8d181f47fc67914798c4b96990e835fc1407bf4673ead30e2	0	2
0x393fc3aD526e48418f1	DONE	0	3
0x3d3f47Af52F8ff37bDECCFdC2B6402d52FFea314	100.00 ETH	0	4
0x6D578BDeAE84A710f4E7a85608848e9fE9eC7B3F	100.00 ETH	0	5
0x3702ff226DA6918428F9E016b5CB5760f43eD3F5	100.00 ETH	0	6

Rinkeby: Authenticated Faucet x +

https://faucet.rinkeby.io



Rinkeby Authenticated Faucet

Social network URL containing your Ethereum address... Give me Ether ▾

8 peers 3746471 blocks 9.046256971665328e+56 Ethers 247585 funded

How does this work?

This Ether faucet is running on the Rinkeby network. To prevent malicious actors from exhausting all available funds or accumulating enough Ether to mount long running spam attacks, requests are tied to common 3rd party social network accounts. Anyone having a Twitter, Google+ or Facebook account may request funds within the permitted limits.

-  To request funds via Twitter, make a **tweet** with your Ethereum address pasted into the contents (surrounding text doesn't matter). Copy-paste the **tweets URL** into the above input box and fire away!
-  To request funds via Google Plus, publish a new **public** post with your Ethereum address embedded into the content (surrounding text doesn't matter). Copy-paste the posts URL into the above input box and fire away!
-  To request funds via Facebook, publish a new **public** post with your Ethereum address embedded into the content (surrounding text doesn't matter). Copy-paste the **posts URL** into the above input box and fire away!

You can track the current pending requests below the input field to see how much you have to wait until your turn comes.

The faucet is running invisible reCaptcha protection against bots.

[Privacy - Terms](#)

Chapter 7: Populus Development Framework

```
===== test session starts =====
platform linux -- Python 3.6.7, pytest-4.1.1, py-1.7.0, pluggy-0.8.1
rootdir: /home/arjuna/Documents/WritingBook/hands-on-blockchain-for-python-developers/chapter_05/populus_tutorial, infile:
plugins: populus-2.2.0
collected 5 items

tests/test_donation.py ..... [100%]

===== 5 passed in 2.41 seconds =====
```

```
===== test session starts =====
platform linux -- Python 3.6.7, pytest-4.1.1, py-1.7.0, pluggy-0.8.1
rootdir: /home/arjuna/Documents/WritingBook/hands-on-blockchain-for-python-developers/chapter_05/populus_tutorial, infile:
plugins: populus-2.2.0
collected 1 item

tests/test_greeter2.py . [100%]

===== 1 passed in 0.66 seconds =====
```

Chapter 10: Frontend Decentralized Application

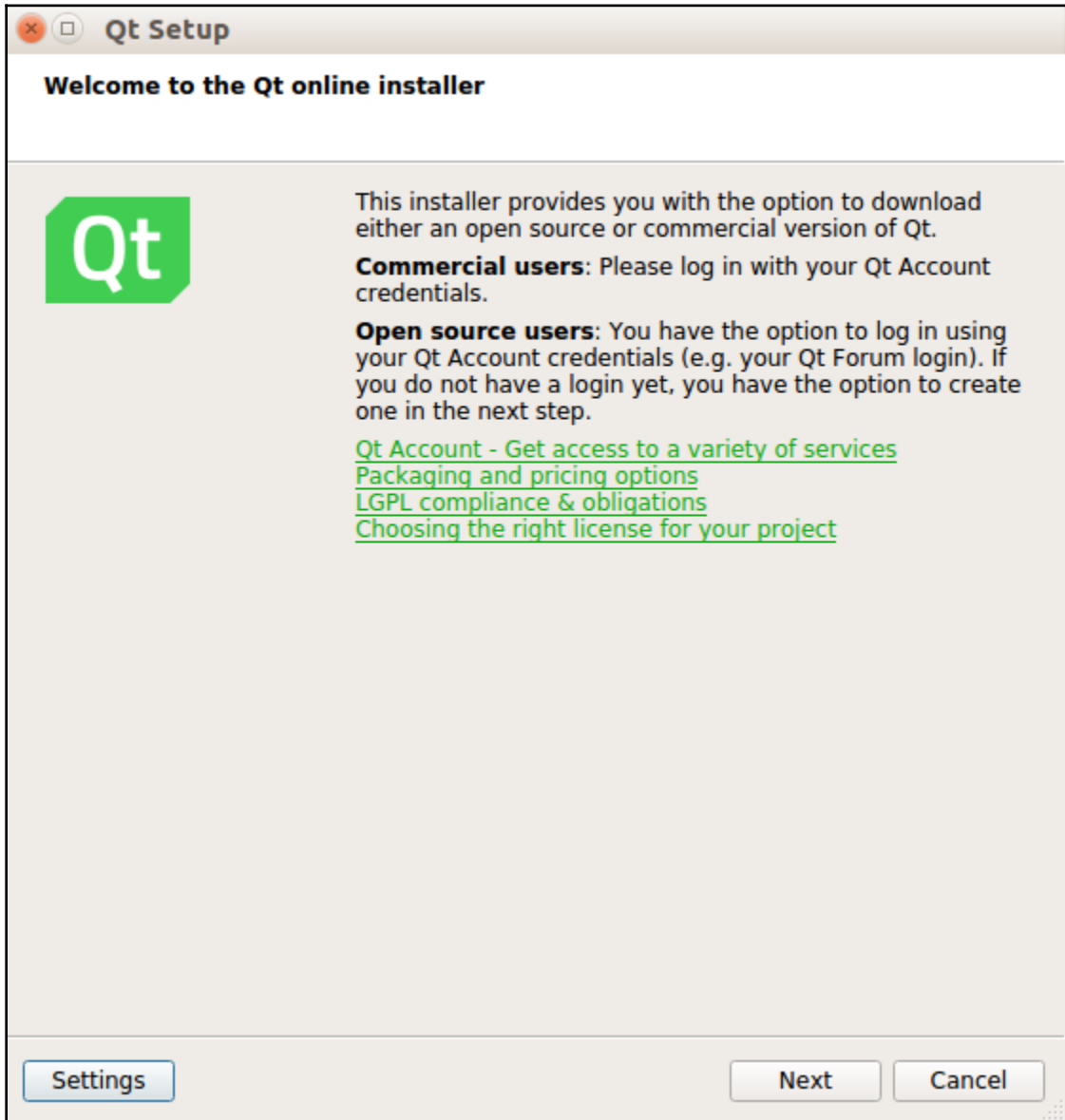

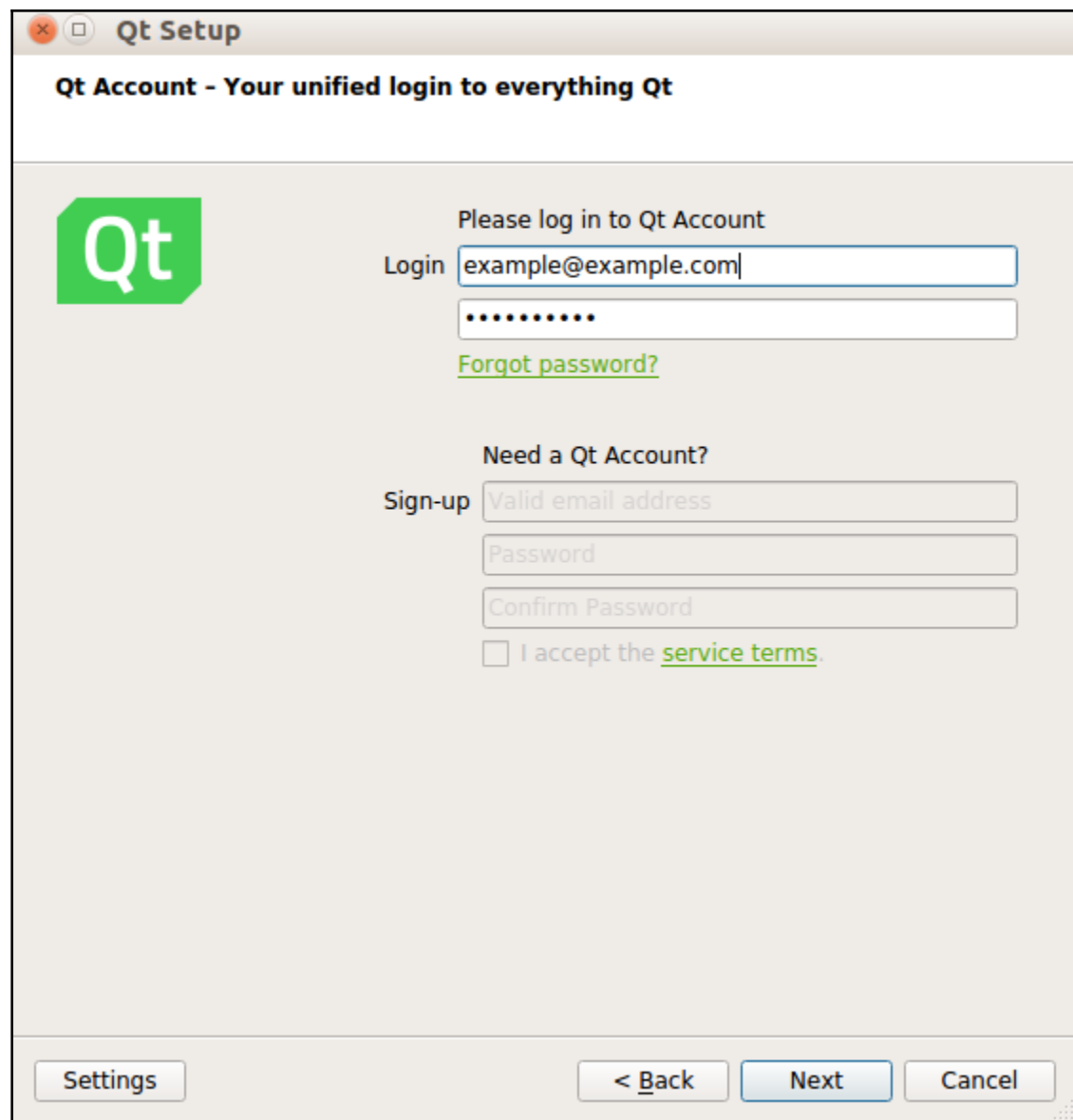

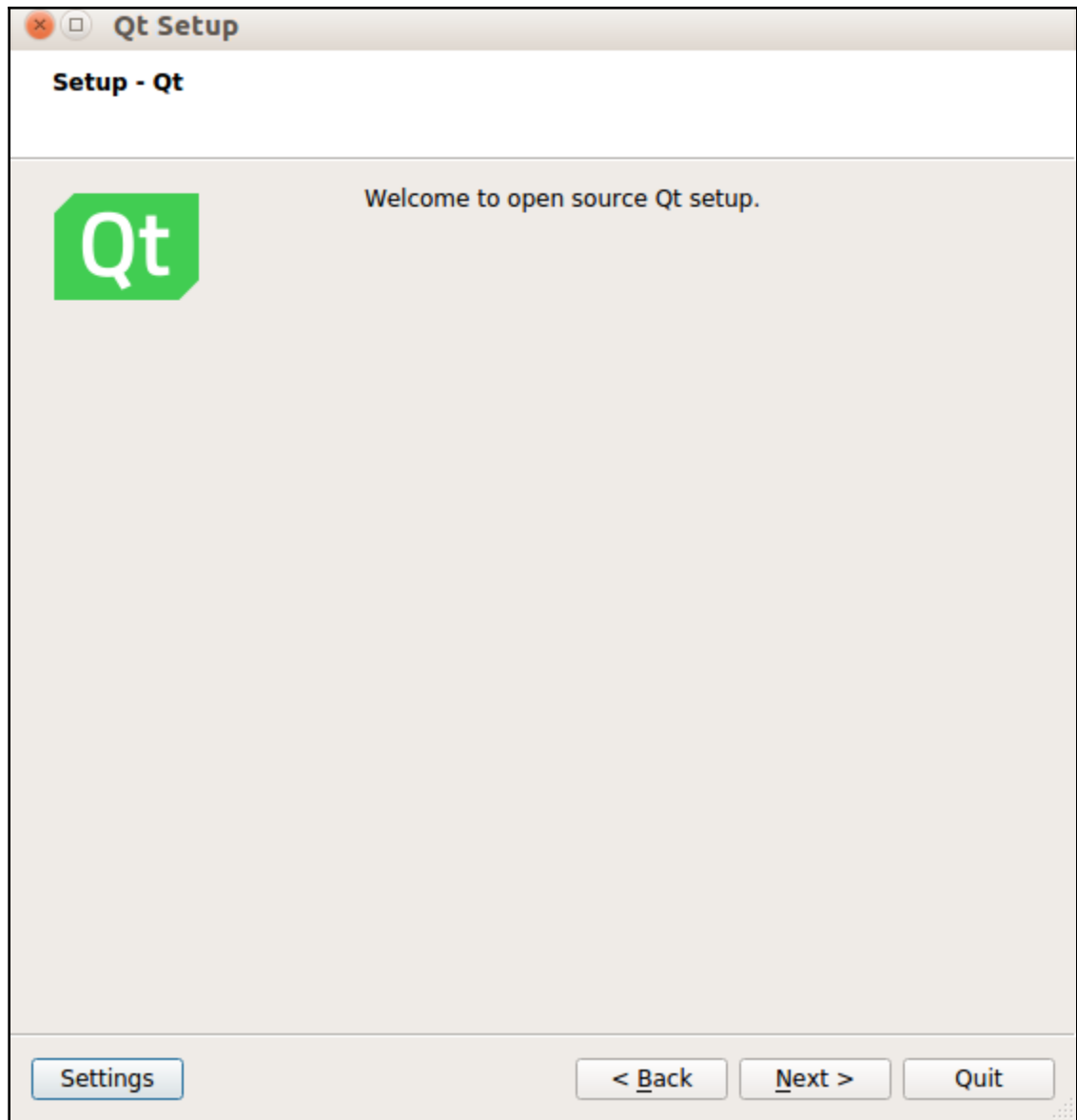

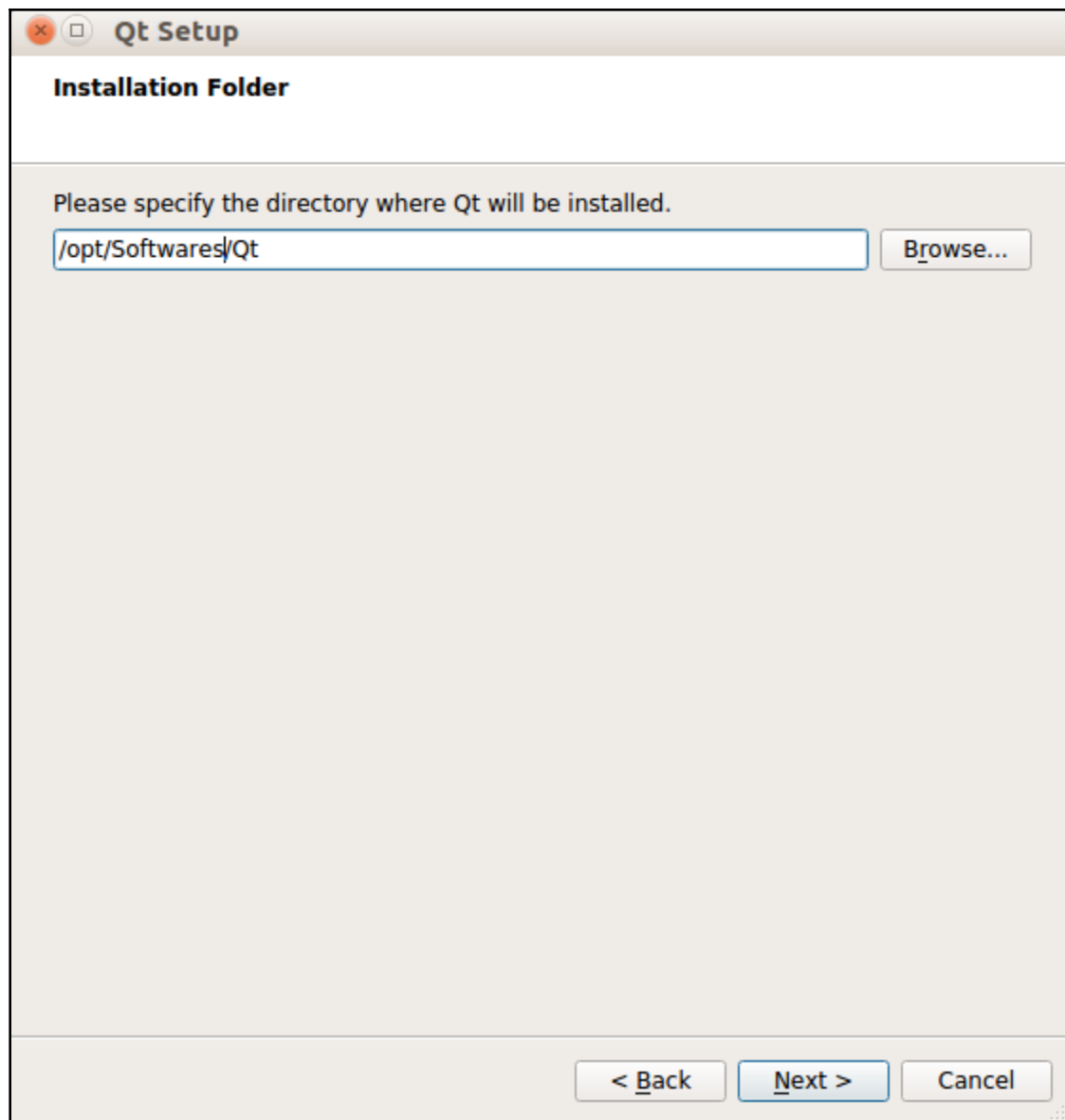

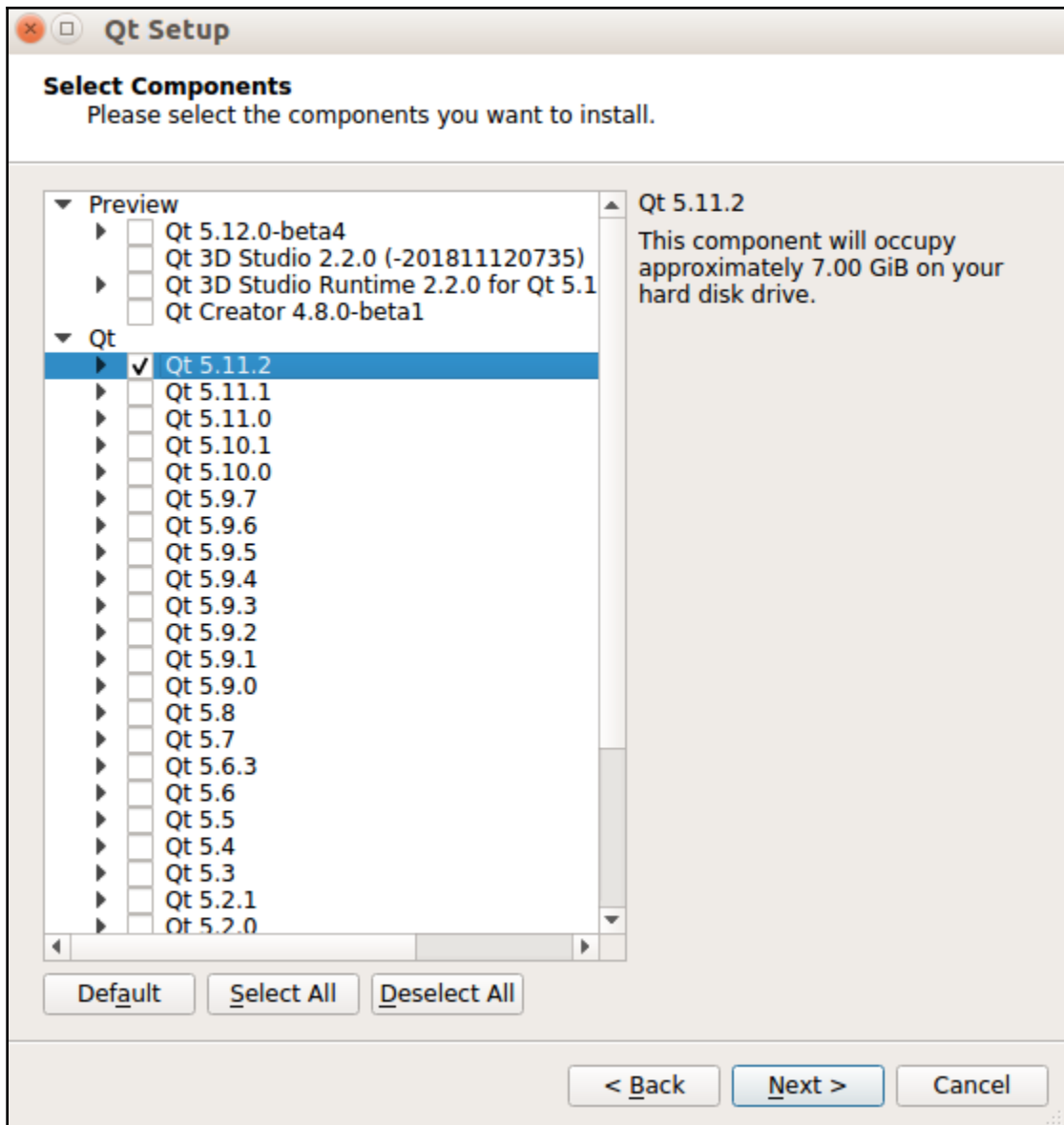

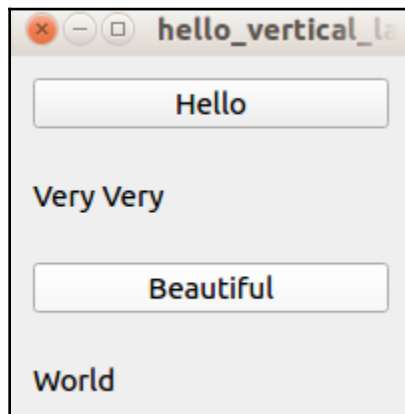
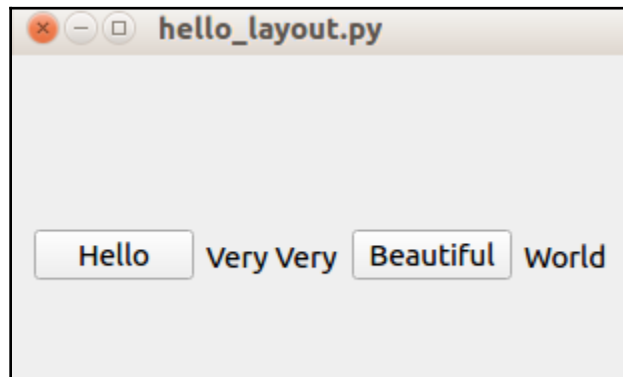
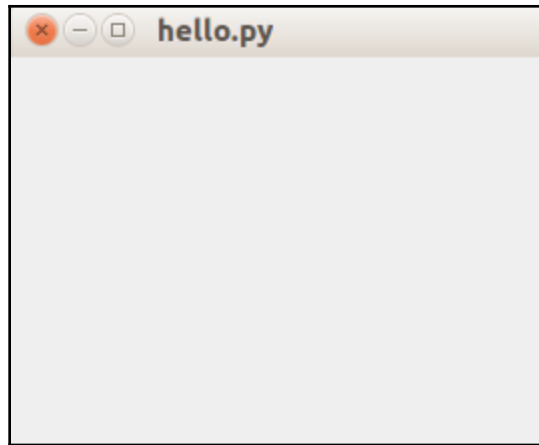

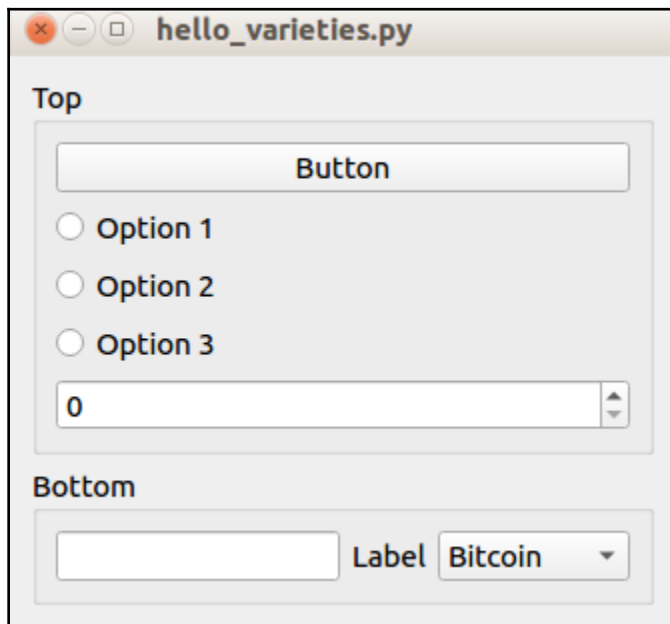
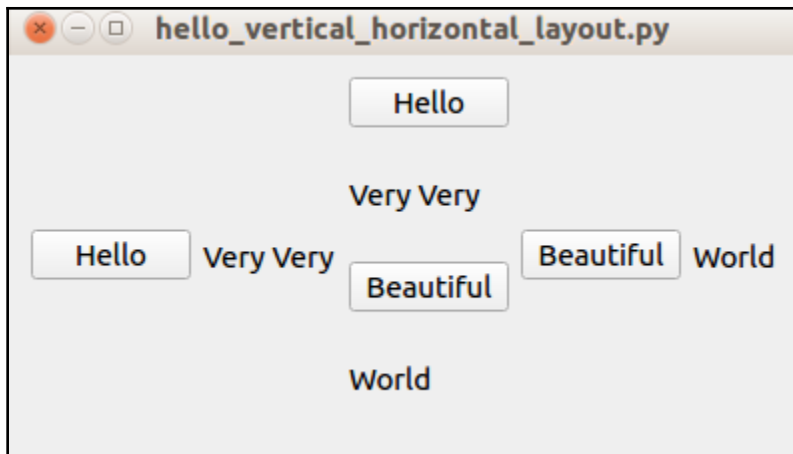

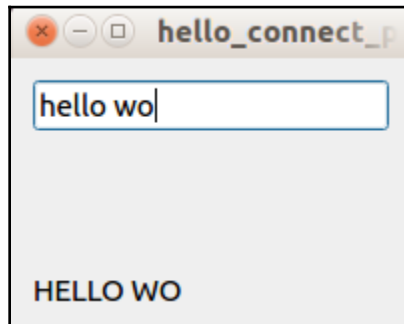
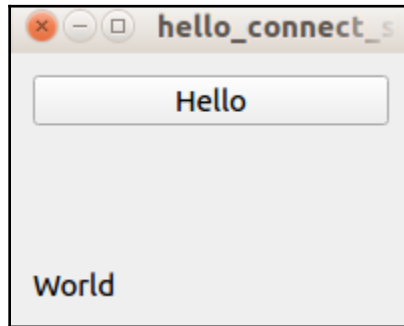
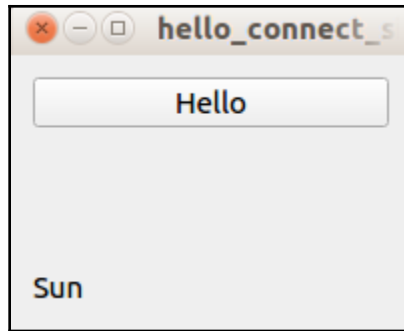

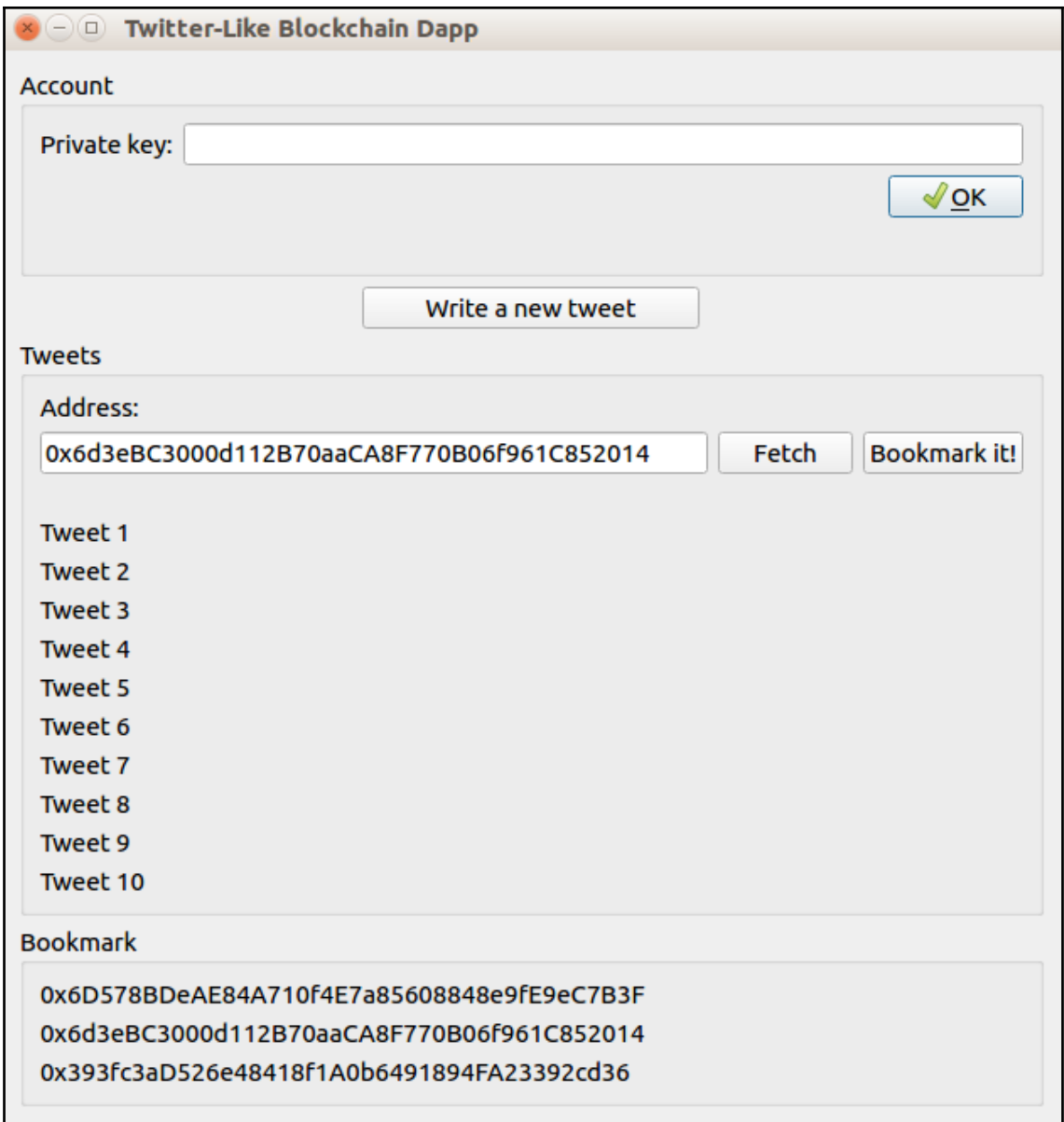

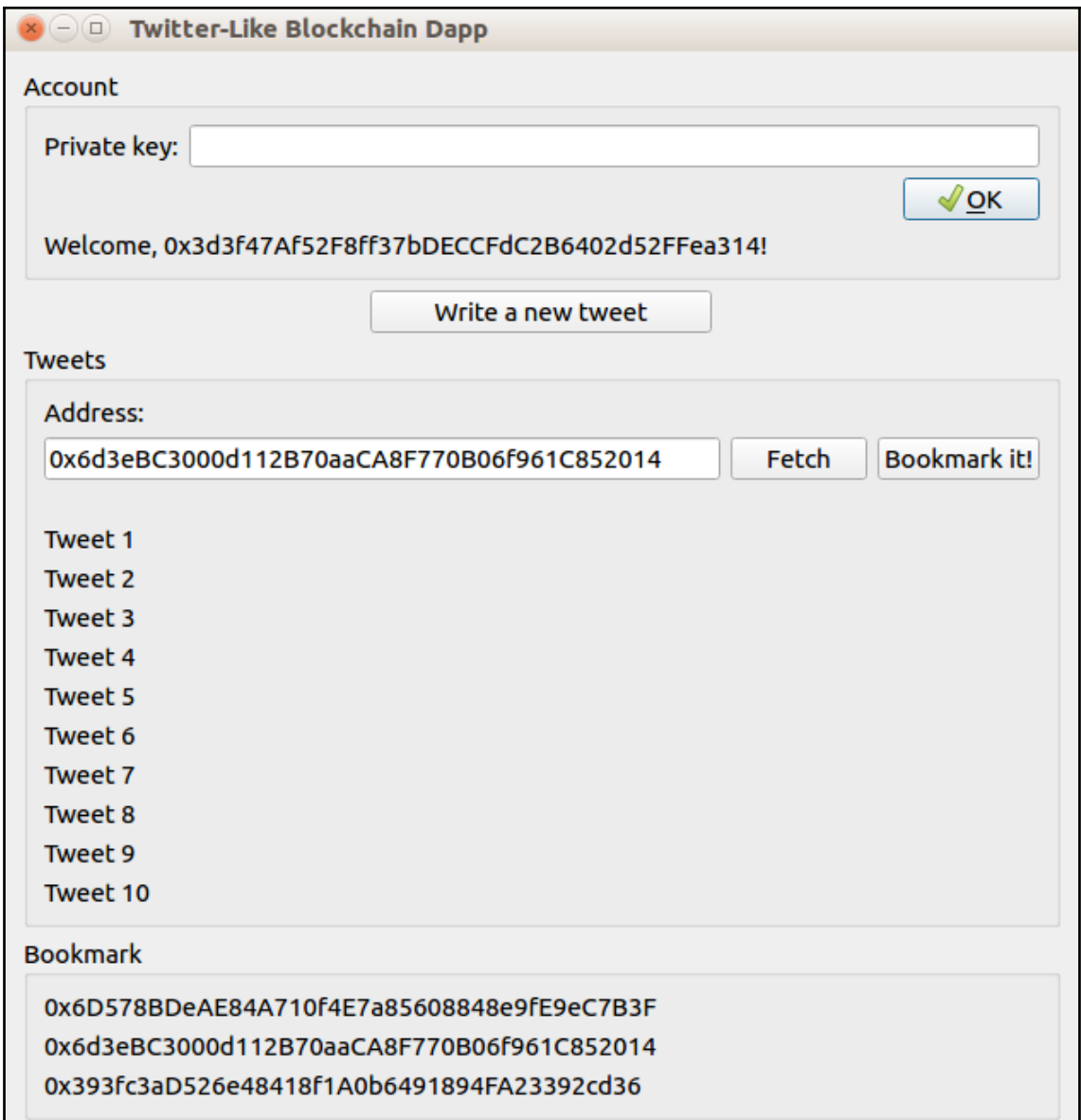

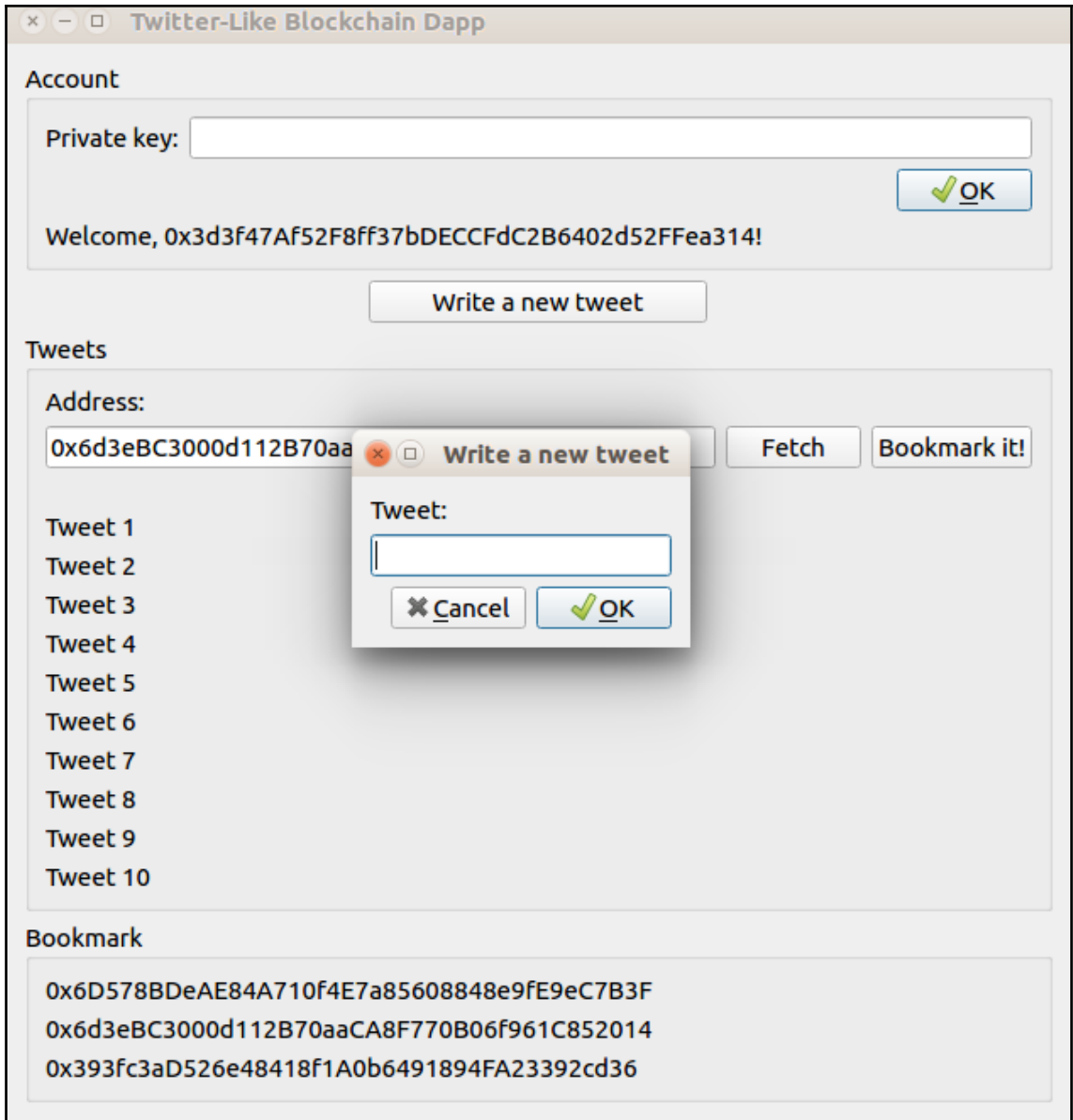

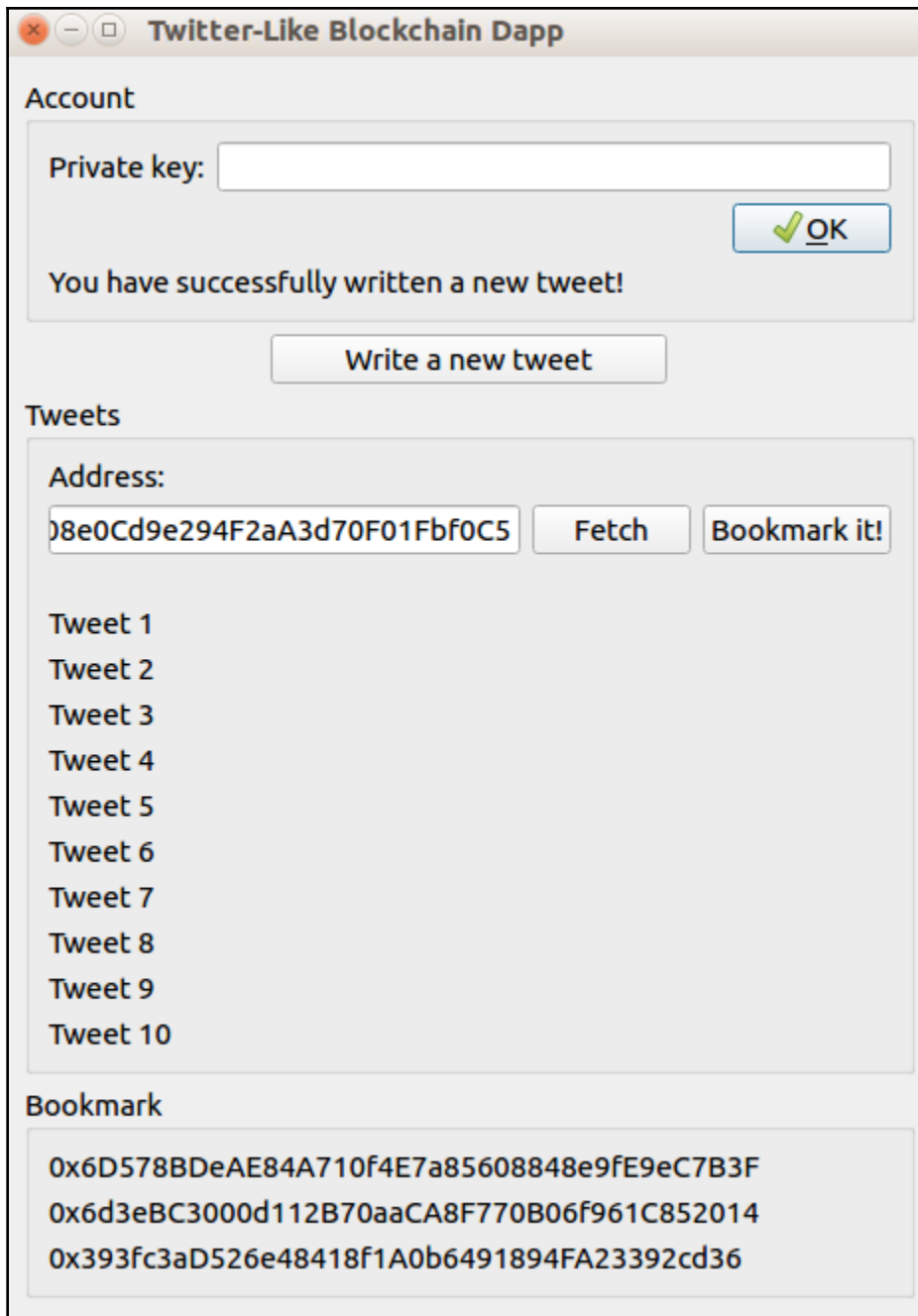

Chapter 12: Creating Token in Ethereum

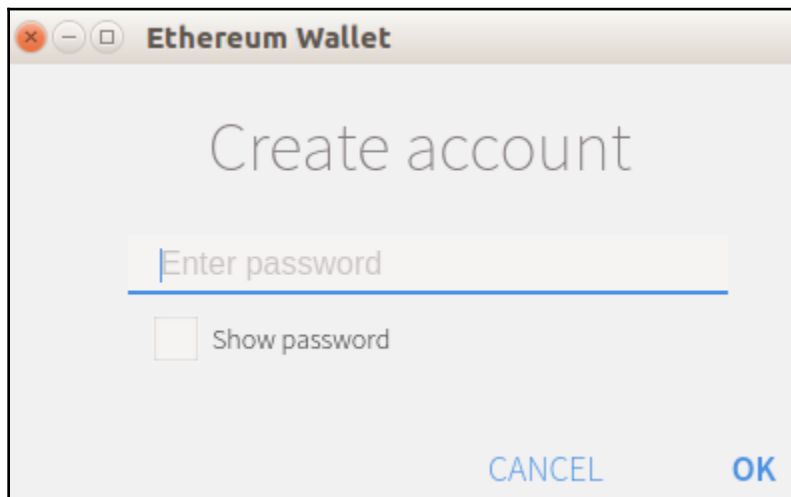
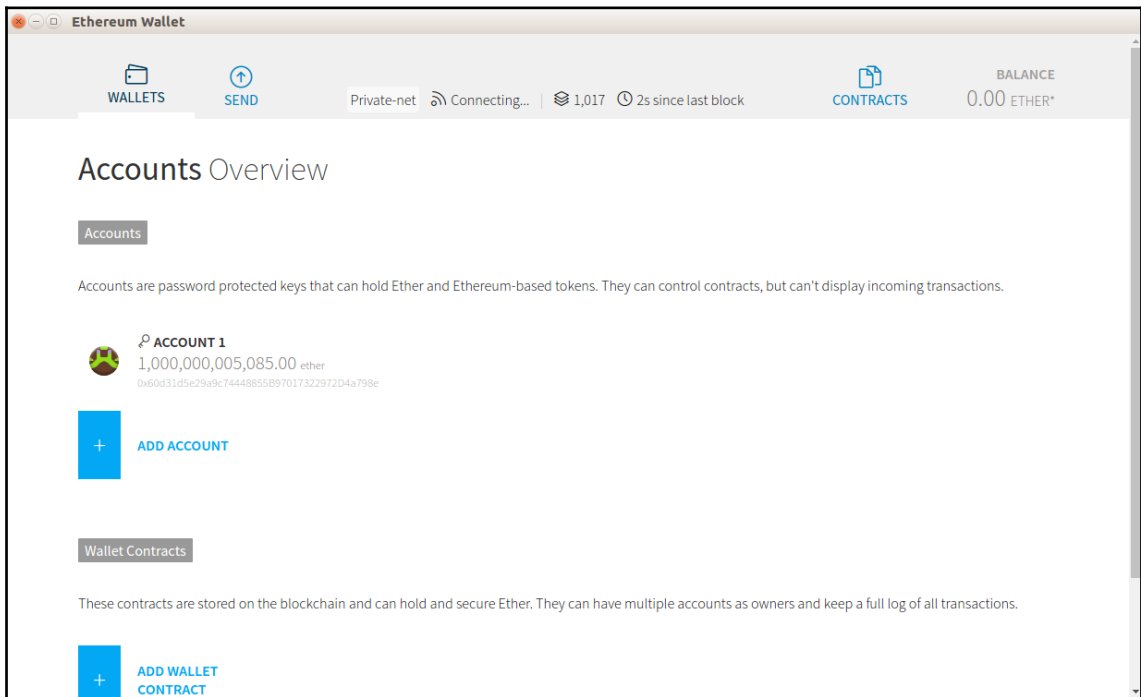

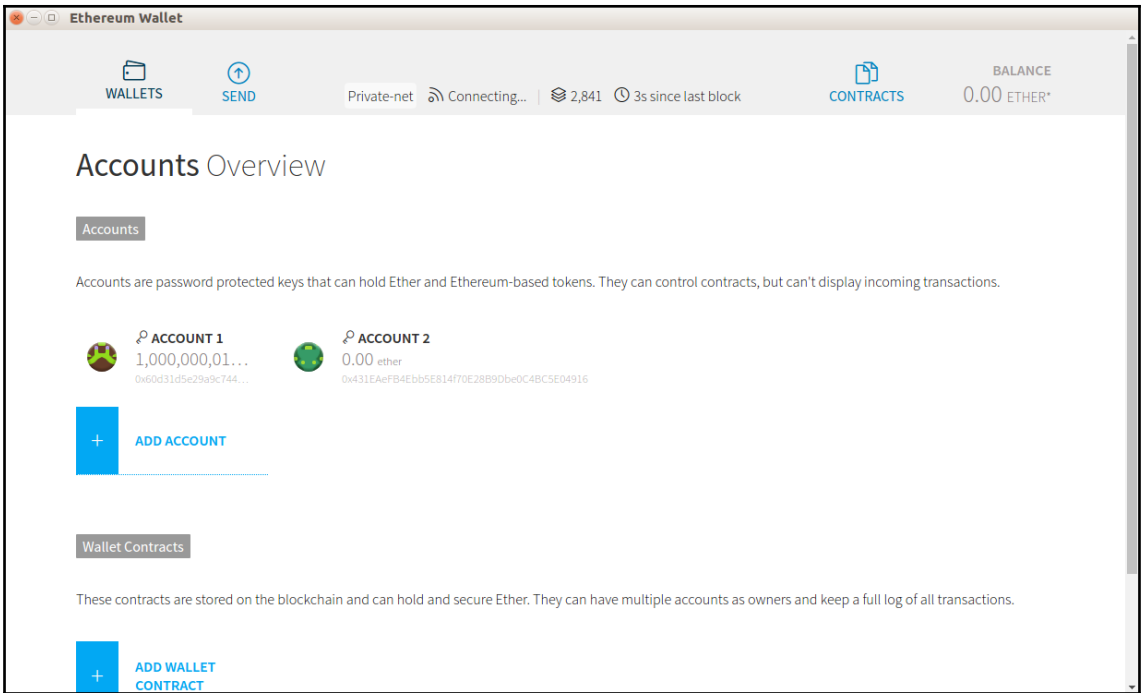



Ethereum Wallet

WALLETS SEND Private-net Connecting... 2,876 11s since last block CONTRACTS 0.00 ETH*

Send funds

FROM  Account 1 - 1,000,000,014,380.00 ETH

TO  0x431EaEfb4Ebb5E814f70E28B9Dbe0C4BC5E04916

AMOUNT ETH 1,000,000,014,380.00 ETH

Send everything

You want to send **10 ETH**.

[SHOW MORE OPTIONS](#)

SELECT FEE

0.000021 ETH

CHEAPER FASTER

TOTAL

10.000021 ETH

[SEND](#)

This is the most amount of money that might be used to process this transaction. Your transaction will be mined **probably within 30 seconds**.

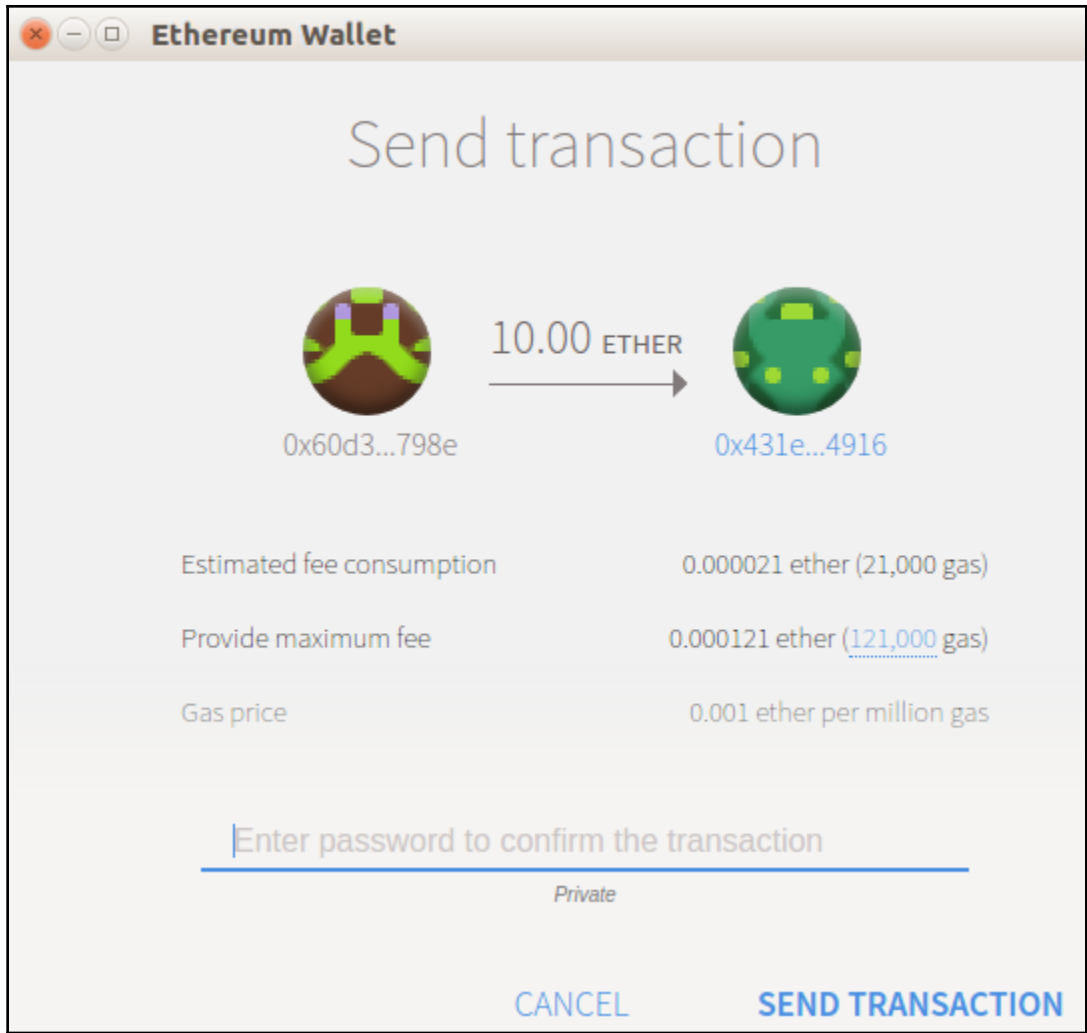

Ethereum Wallet

WALLETS
SEND

Private-net
Connecting...
2,896
7s since last block

CONTRACTS
BALANCE
0.00 ETHER*

Accounts Overview

Accounts

Accounts are password protected keys that can hold Ether and Ethereum-based tokens. They can control contracts, but can't display incoming transactions.

ACCOUNT 1
1,000,000,01...
0x60d31d5e29a9c744...

ACCOUNT 2
10.00 ether
0x431EAeFB4Ebb5E814f70E28B9Dbe0C4BC5E04916

+

ADD ACCOUNT

Wallet Contracts

These contracts are stored on the blockchain and can hold and secure Ether. They can have multiple accounts as owners and keep a full log of all transactions.

+

ADD WALLET CONTRACT

Latest Transactions

Filter transactions

Nov
27

Transfer between accounts

Account 1 → Account 2

3 of 12 Confirmations

10.00 ETHER

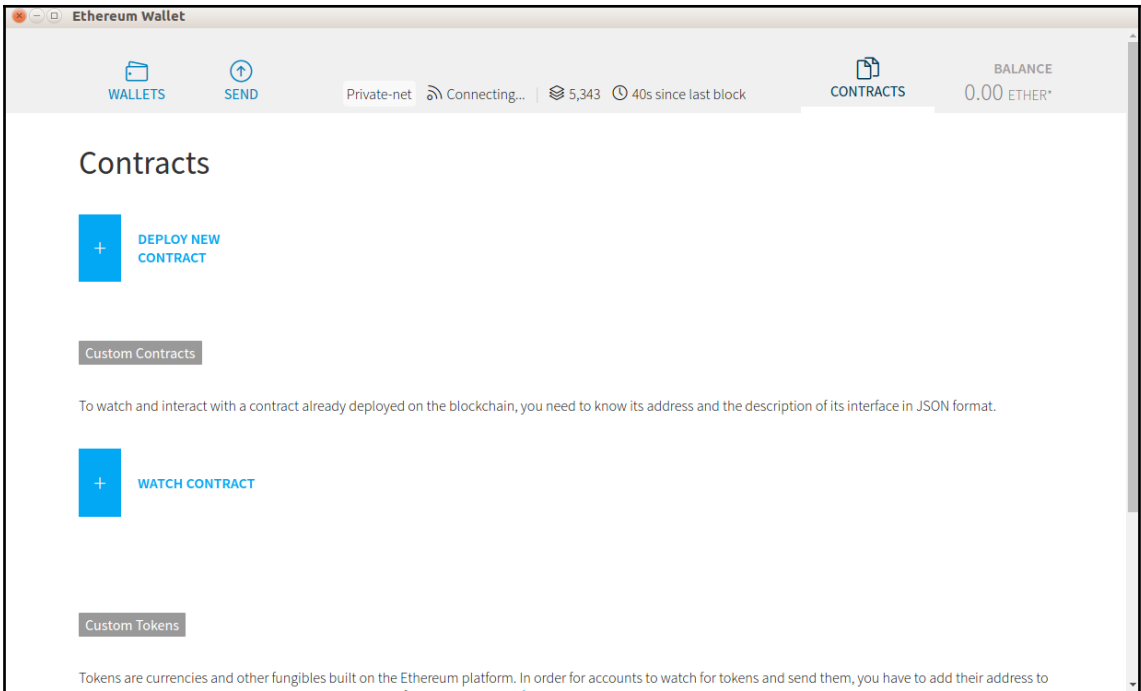

Ethereum Wallet
Private-net Connecting... 3,030 12s since last block

BALANCE
0.00 ETH*

WALLETS
SEND
CONTRACTS

Deploy contract

FROM

Account 1 - 1,000,000,015,140.00 ETH

AMOUNT

ETHER

1,000,000,015,140.00 ETH

Send everything

You want to send **0 ETH**.

SOLIDITY CONTRACT SOURCE CODE

CONTRACT BYTE CODE

```

0x600035601c5274010000000000000000000000000000000000000000000000000000006020526f7fffffffff
ffffffff6040527fffffffffdabf41c006080527fffffffff80000000000000000000000000000000000006060527401
2a05f1ffffffffffffffffdabf41c006080527fffffffffed5fa0e0000000000000000000000000000
0000000000060a05260206102256101403934156100a757600080fd5b610140516000336
0e05260c052604060c0205561020d56600035601c52740100000000000000000000000000
00000000000006020526f7ffffffffffffffff6040527ffffffffffffffff800000000000
00000000000000000060605274012a05f1ffffffffffffffffdabf41c006080527fffffffff
ed5fa0e00000000000000000000000000000000000000060a05263a9059cb6000511415610148

```

SELECT FEE

0.00015389

ETHER

This is the most amount of money that might be used to process this transaction. Your transaction will be mined **probably within 30 seconds**.

Watch contract

CONTRACT ADDRESS



0x3B5B2966cbCC271697F535d9dAC37356c27

CONTRACT NAME

Simple Token

JSON INTERFACE

```
[
  {
    "constant": false,
    "inputs": [
      {
        "name":
"initialSupply",
        "type": "uint256"
      }
    ]
  },
  ...
]
```

CANCEL

OK

Ethereum Wallet

WALLETS SEND Private-net Connecting... 3,949 34s since last block CONTRACTS BALANCE 0.00 ETH*

Simple Token

0x4823EDdB63aD6AbccD581EE75aA021dDF051dE69
0.00 ETH*

- Transfer Ether & Tokens
- Copy address
- Show QR-Code
- Show Interface

HIDE CONTRACT INFO

Read From Contract Write To Contract

Balances

Arg 0 - address

0x60d31d5e29a9c74448855B97017322972D4a798e

Out
10000

Latest Events

Watch contract events

Select function

Pick A Function

WALLETS SEND Private-net Connecting... 8,278 16s since last block CONTRACTS 0.00 ETH

Simple Token

0x6c746942a8f11c2b6027aefbdc0646c00ea3421
0.00 ETH

HIDE CONTRACT INFO

Read From Contract

Balances

Arg 0 - address

0x123456...

Write To Contract

Select function

Transfer

to - address

0x431EaEfb4Ebb5E81470E28B9Dbe0C4BC5E04916

amount - 256 bits unsigned integer

20

Execute from

Account 1 - 1,000,000,041,380.00 ETH

EXECUTE

WALLETS SEND Private-net Connecting... 8,307 22s since last block CONTRACTS BALANCE 0.00 ETH

Simple Token

0x6c746942a8f11c2b6027aefbdc0646c00ea3421
0.00 ETH

HIDE CONTRACT INFO

Read From Contract

Balances

Arg 0 - address

0x431EaEfb4Ebb5E81470E28B9Dbe0C4BC5E04916

Out

20

Write To Contract

Select function

Pick A Function

Latest Events

Watch contract events

Add token

TOKEN CONTRACT ADDRESS



0xF43876d27fE11F7cebE6C43f68c24d8549DA4

TOKEN NAME

Haha Coin

TOKEN SYMBOL

HAH

DECIMALS PLACES OF SMALLEST UNIT

3

PREVIEW

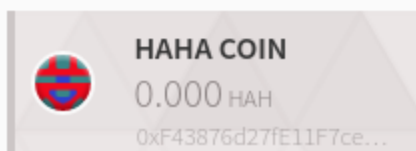

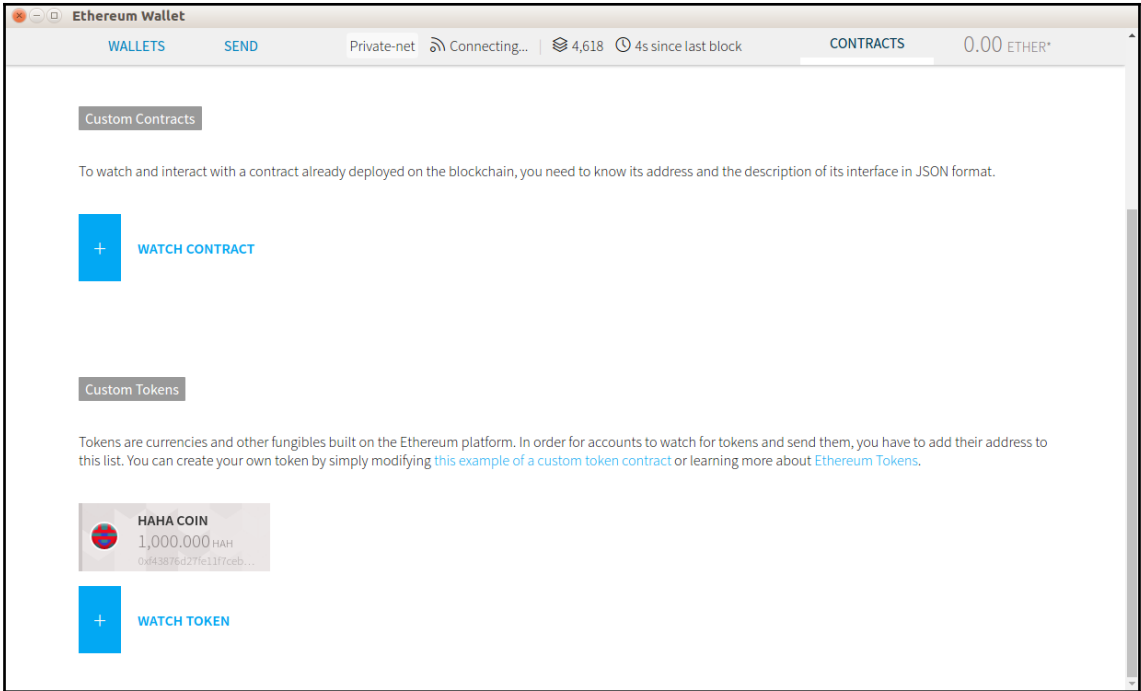

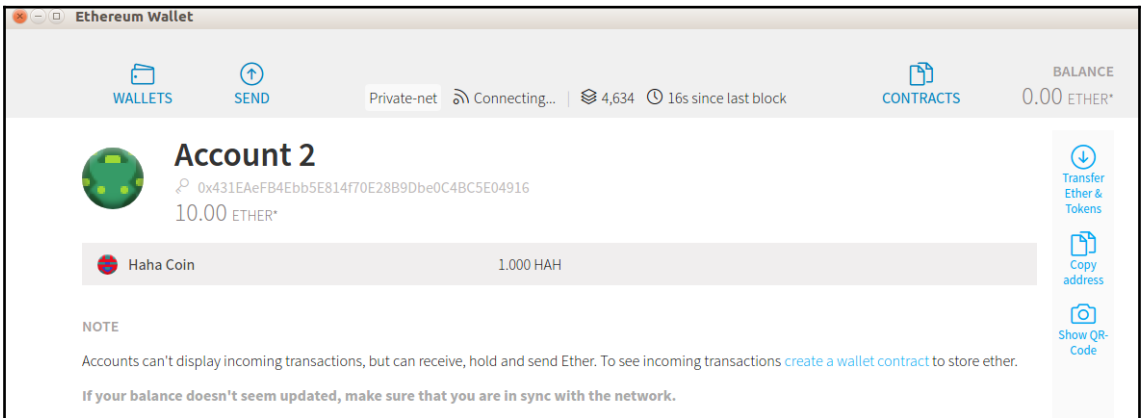
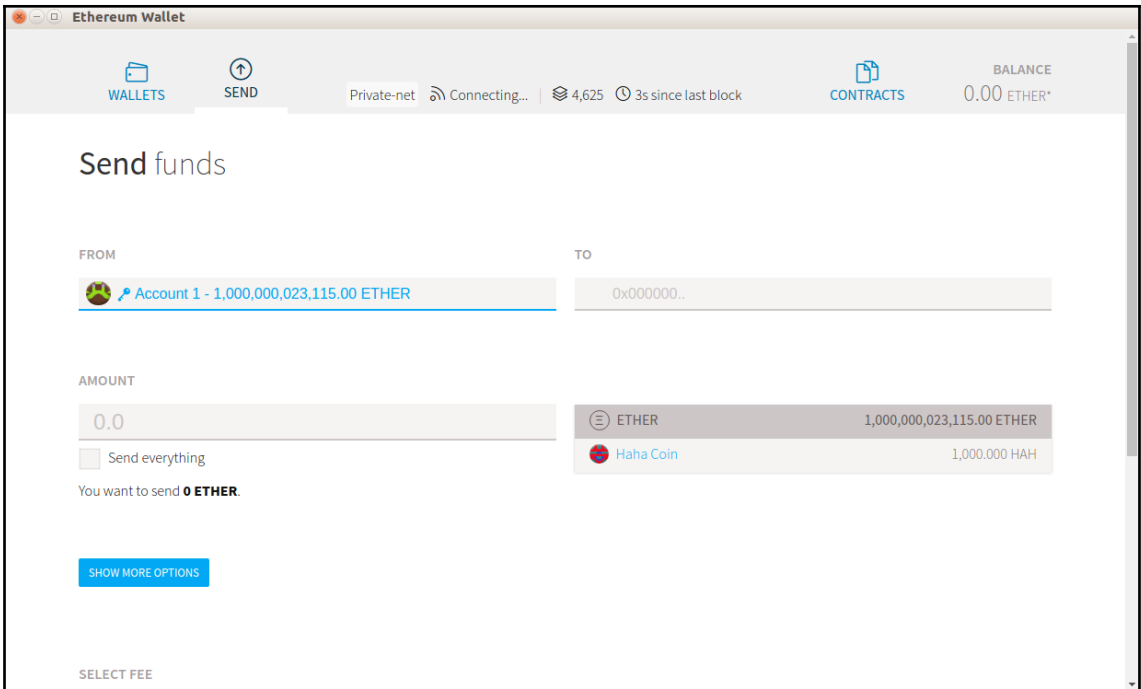

Chapter 13: Cryptocurrency Wallet

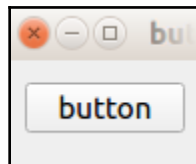
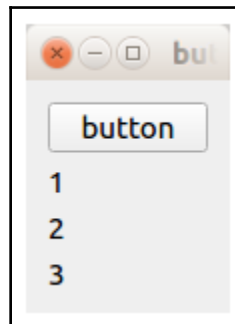
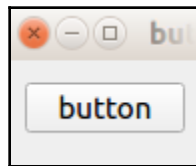
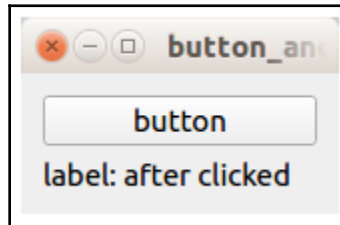
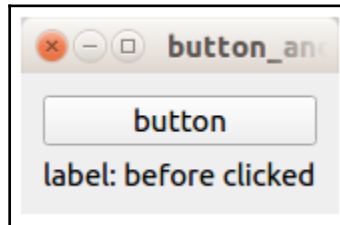

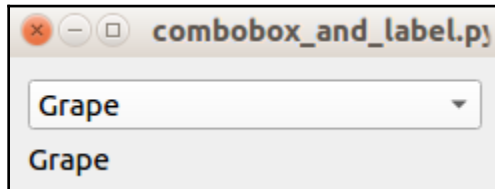
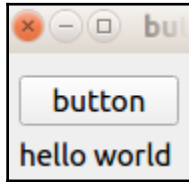
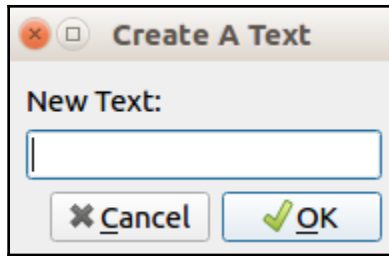

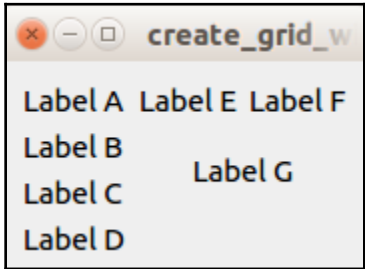
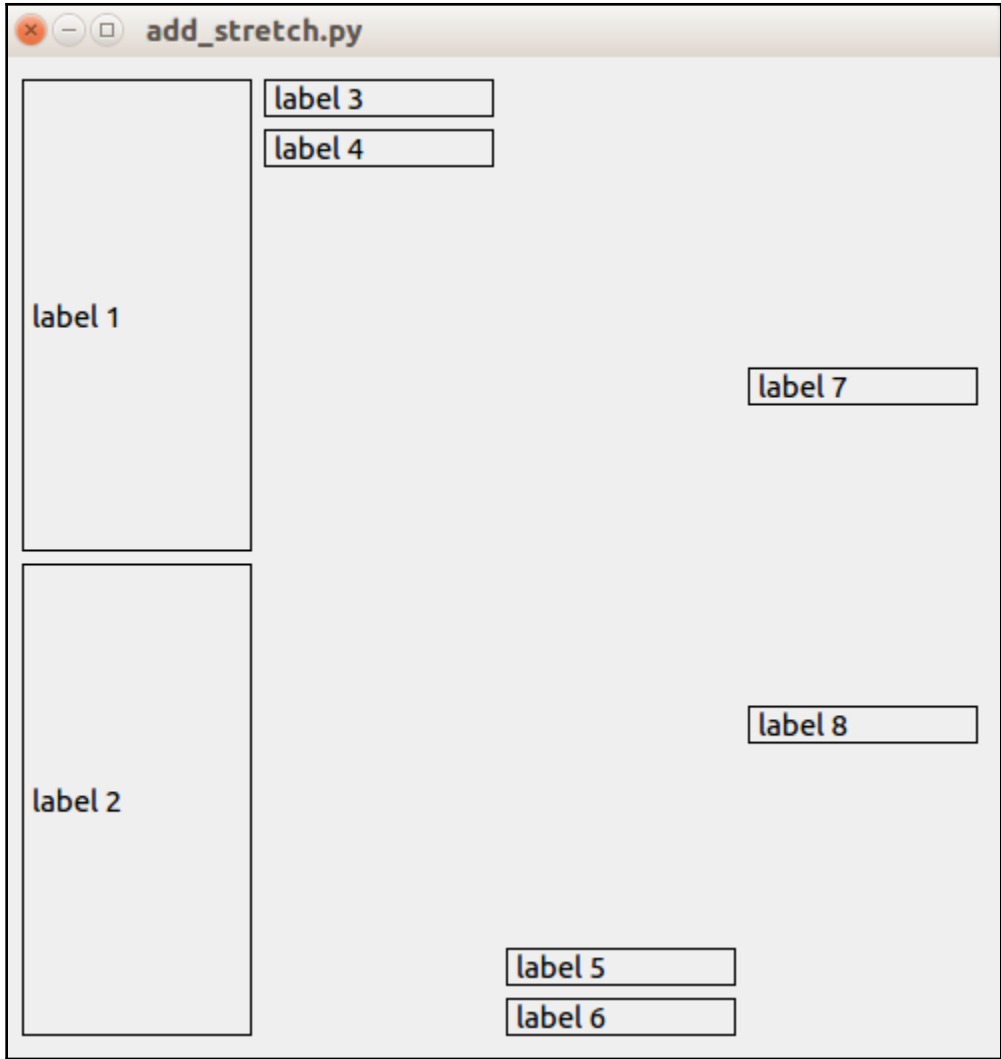



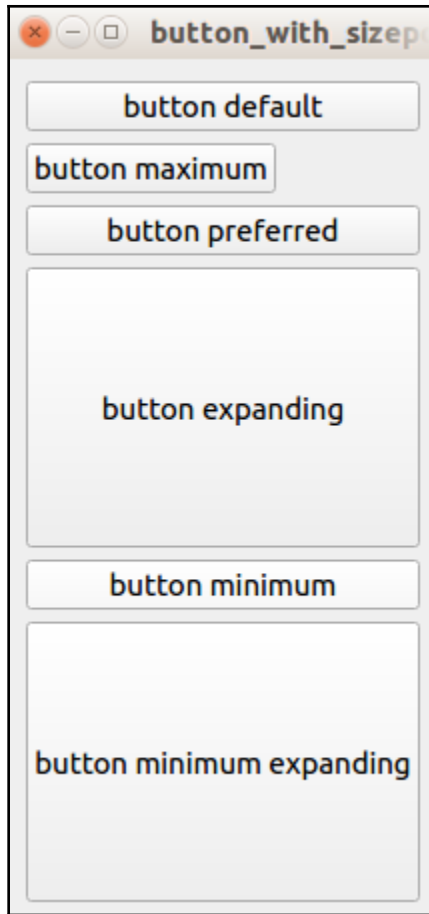

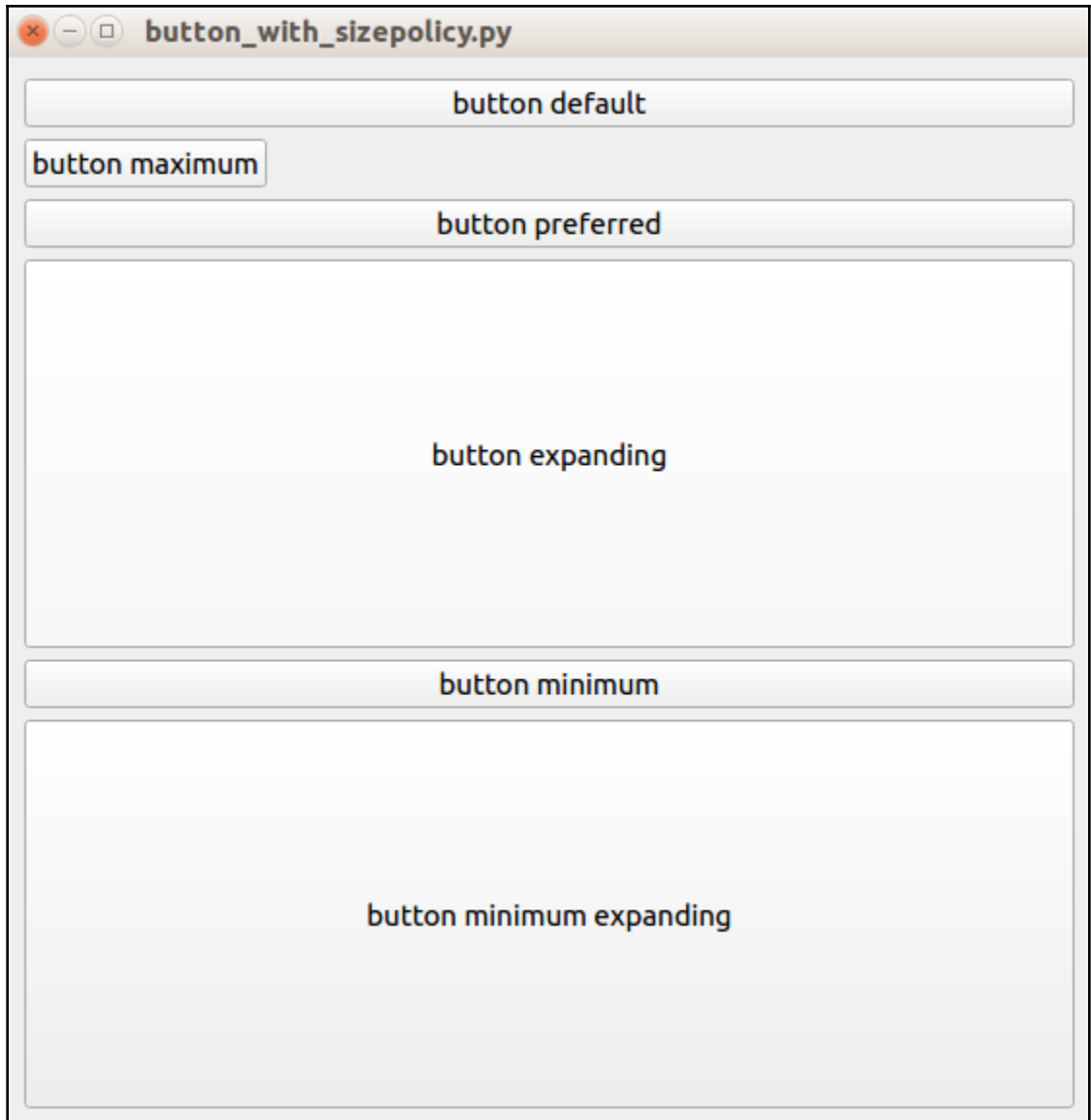

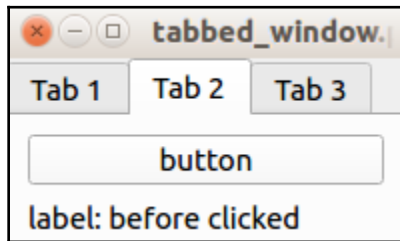
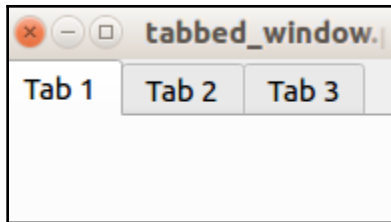

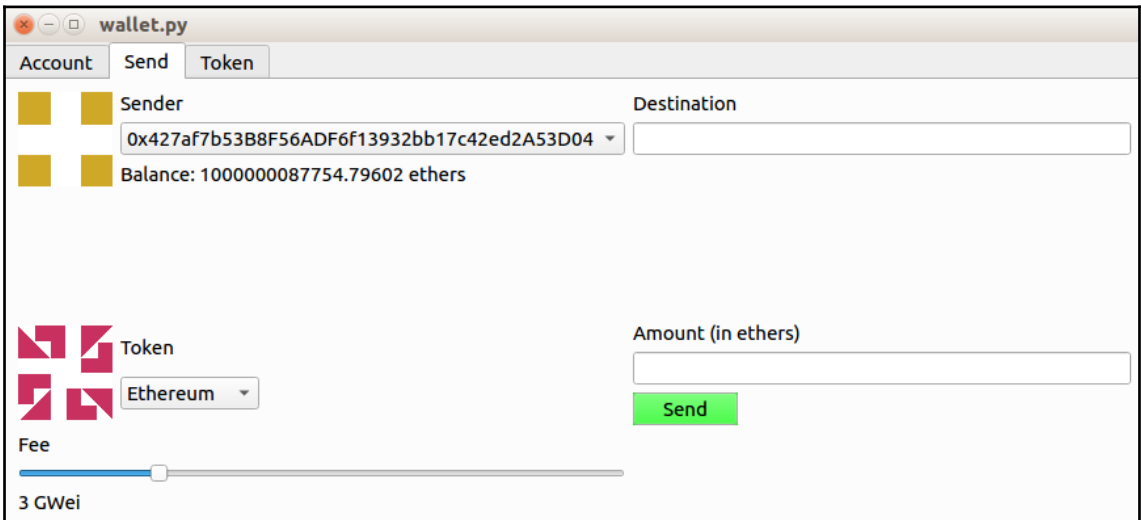
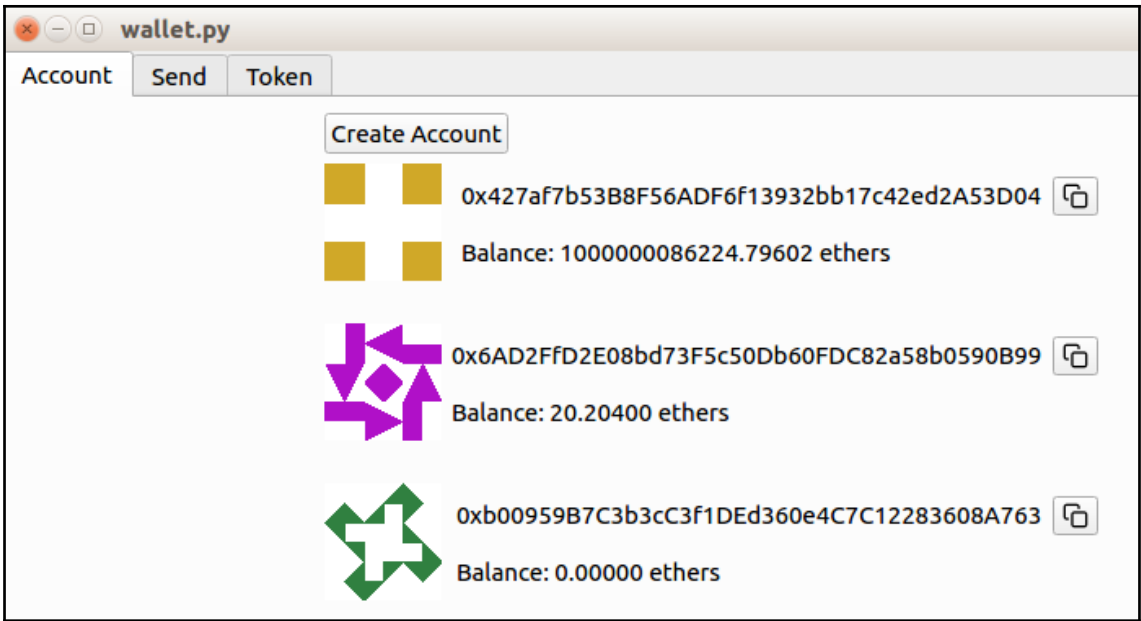

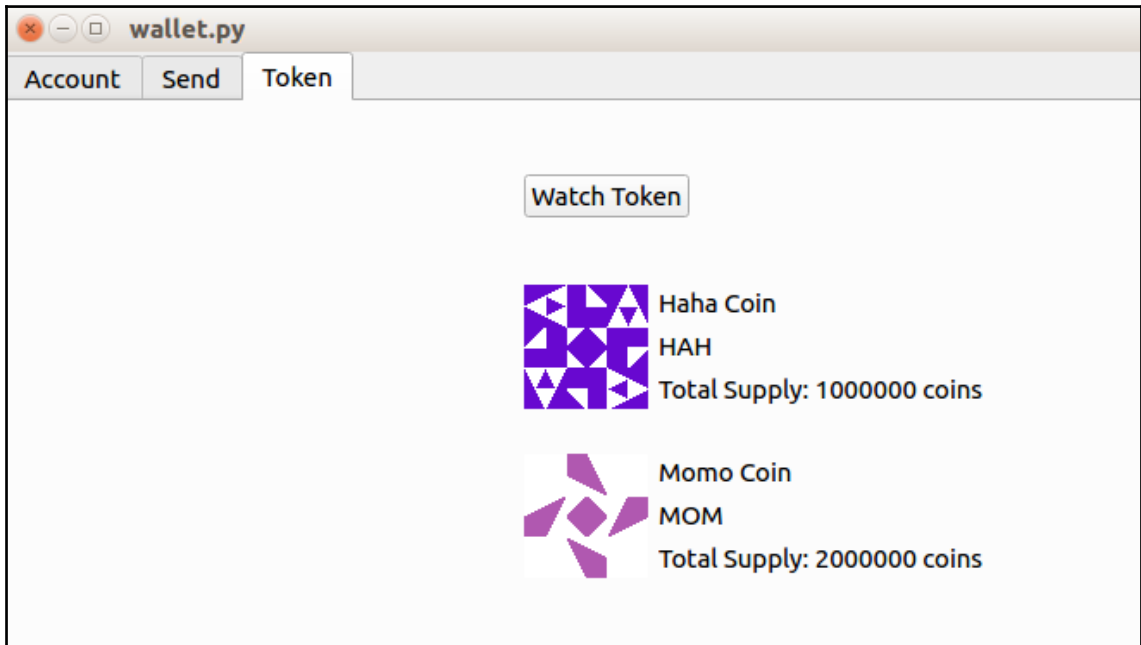
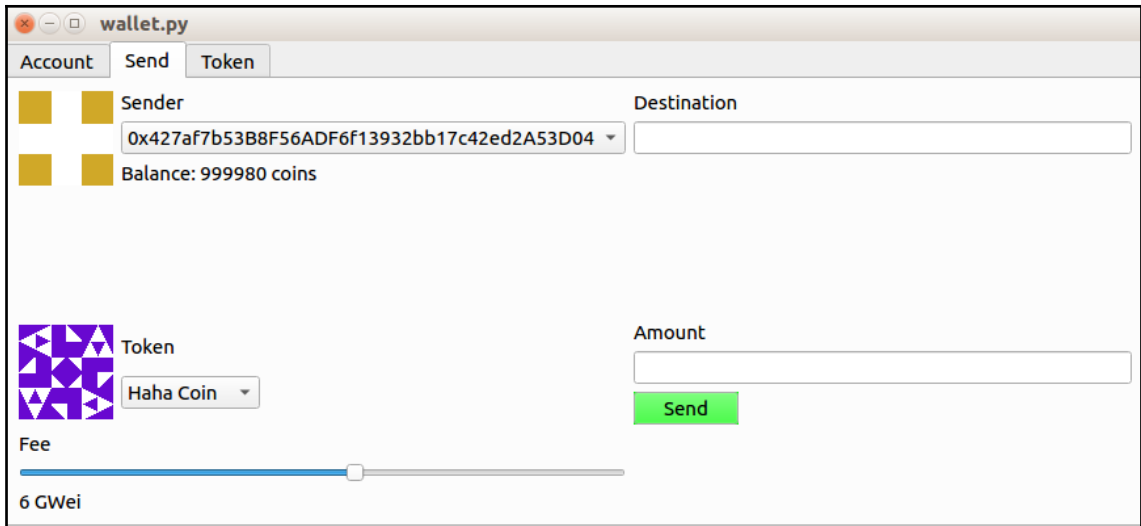

Chapter 15: InterPlanetary - A Brave New File System

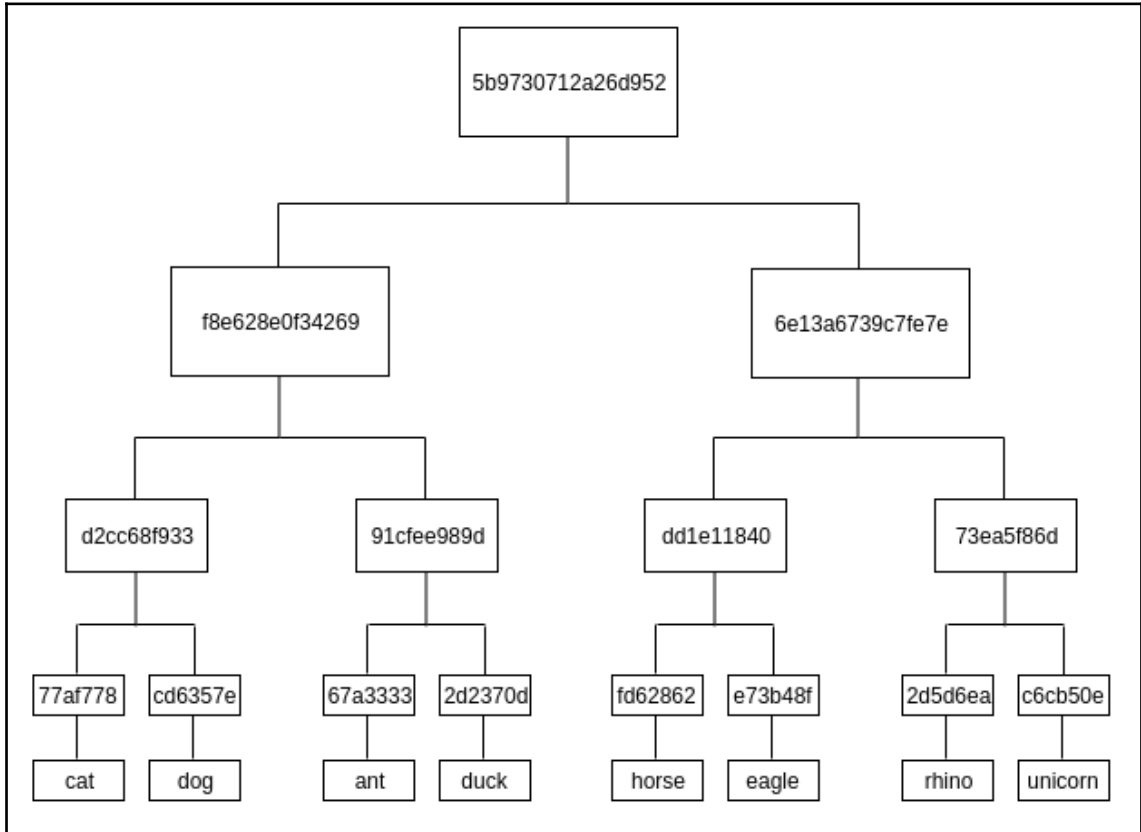

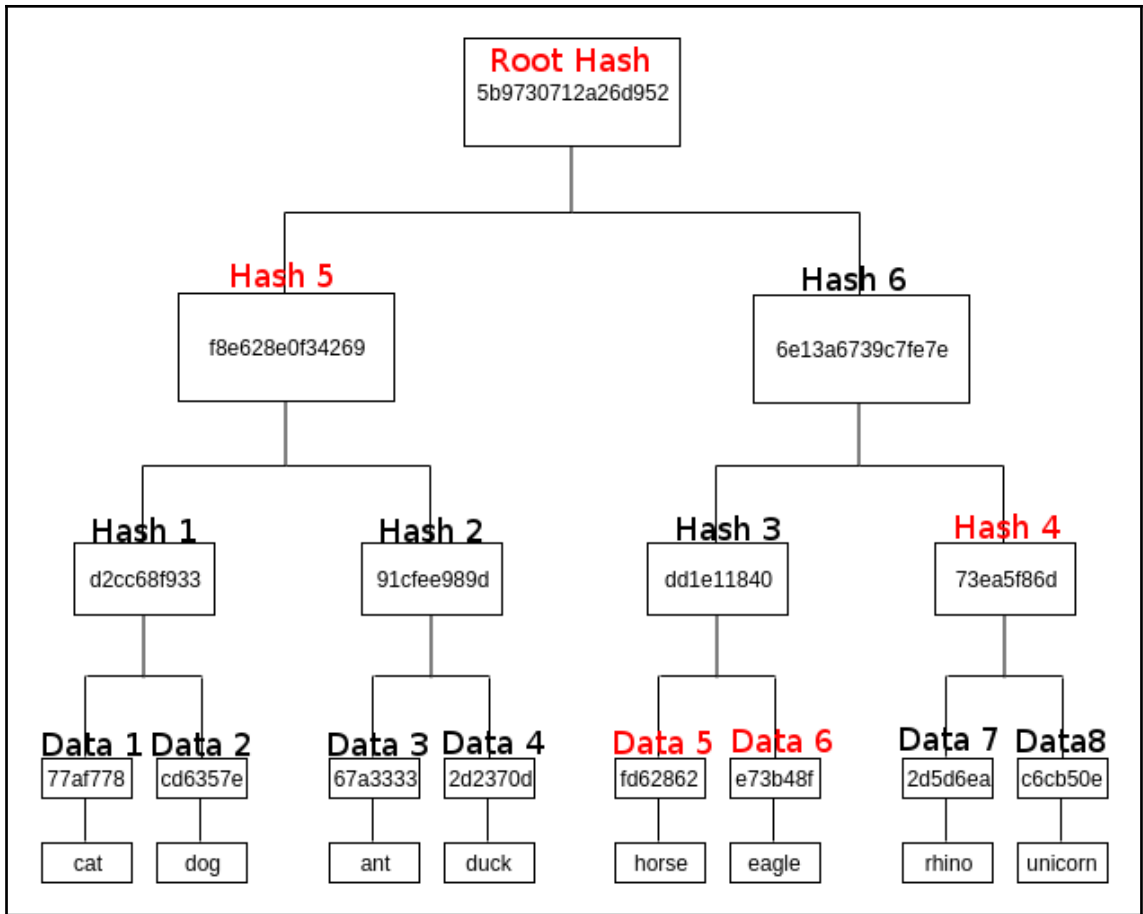

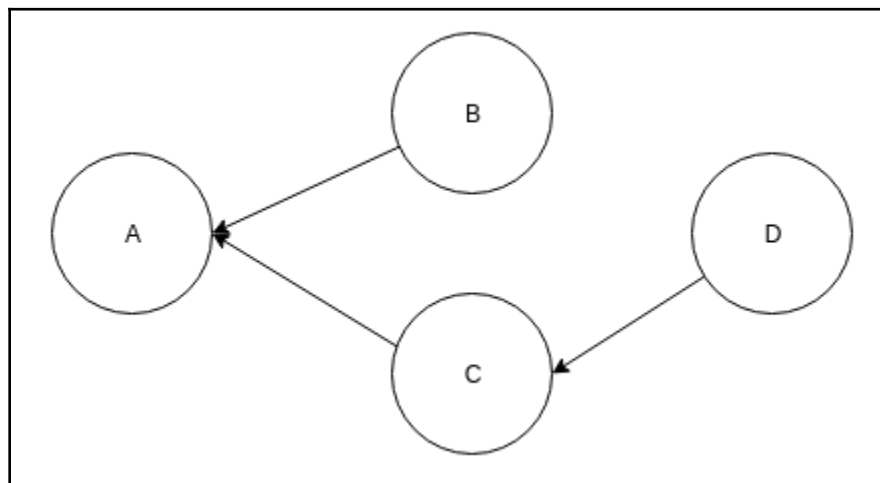
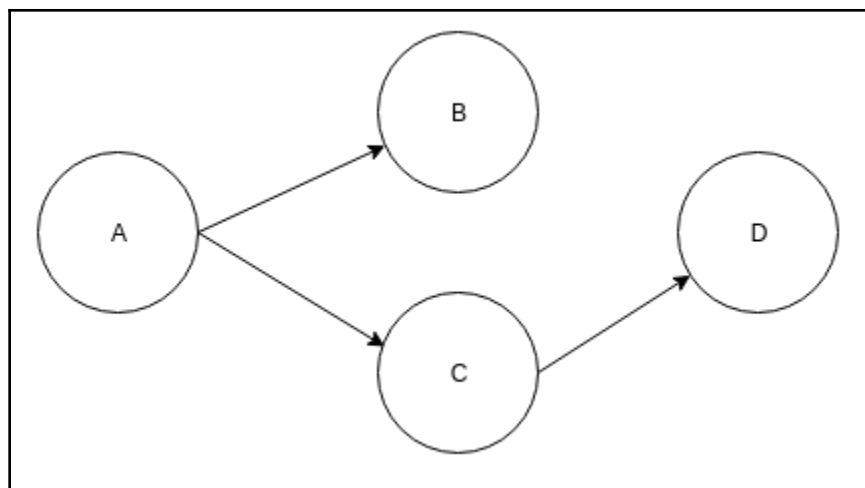

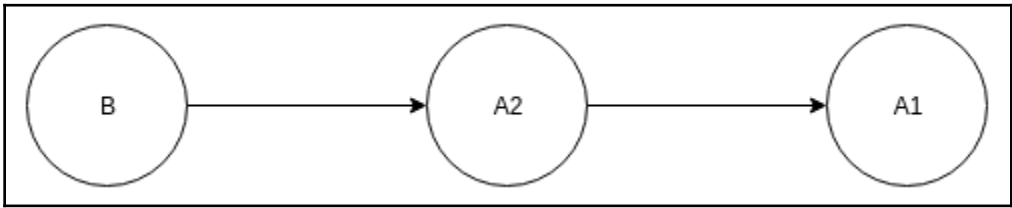
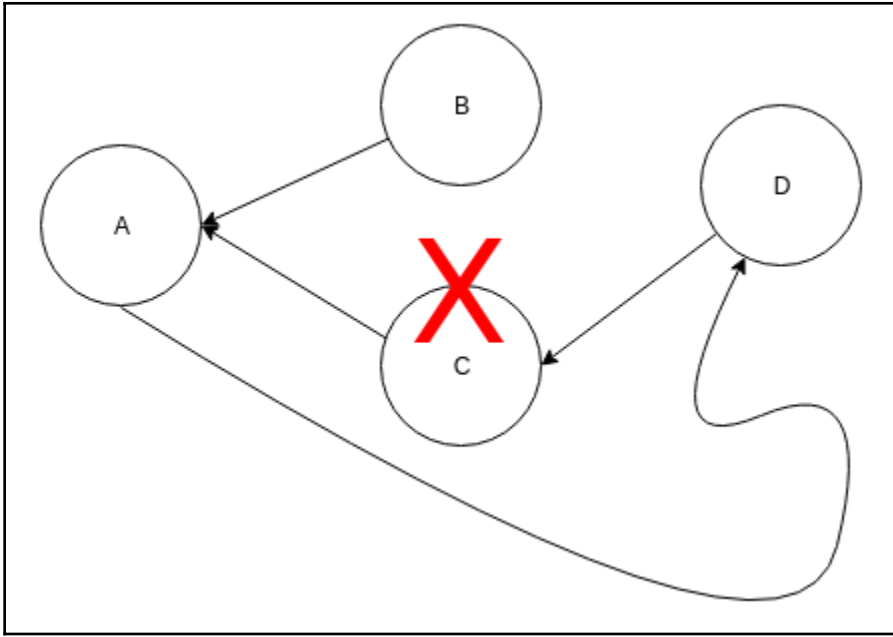

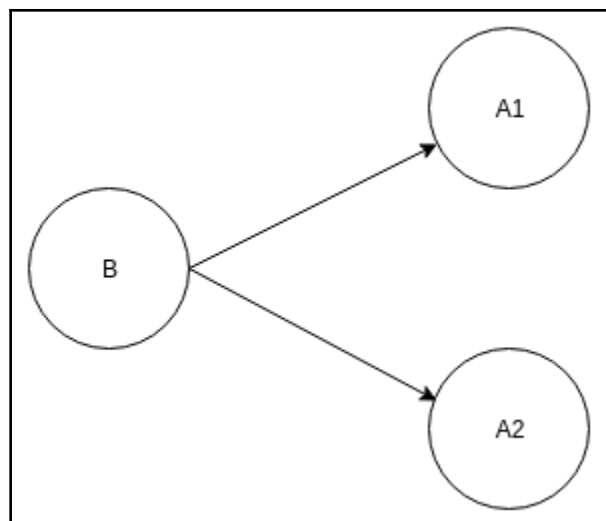

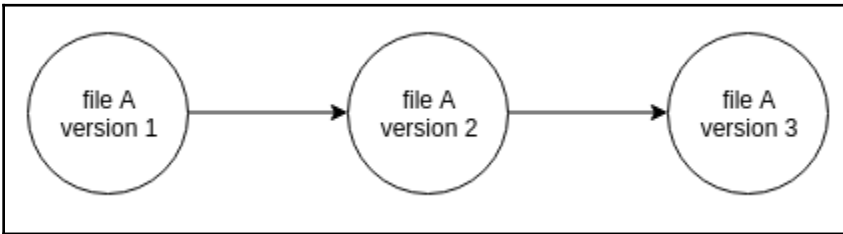
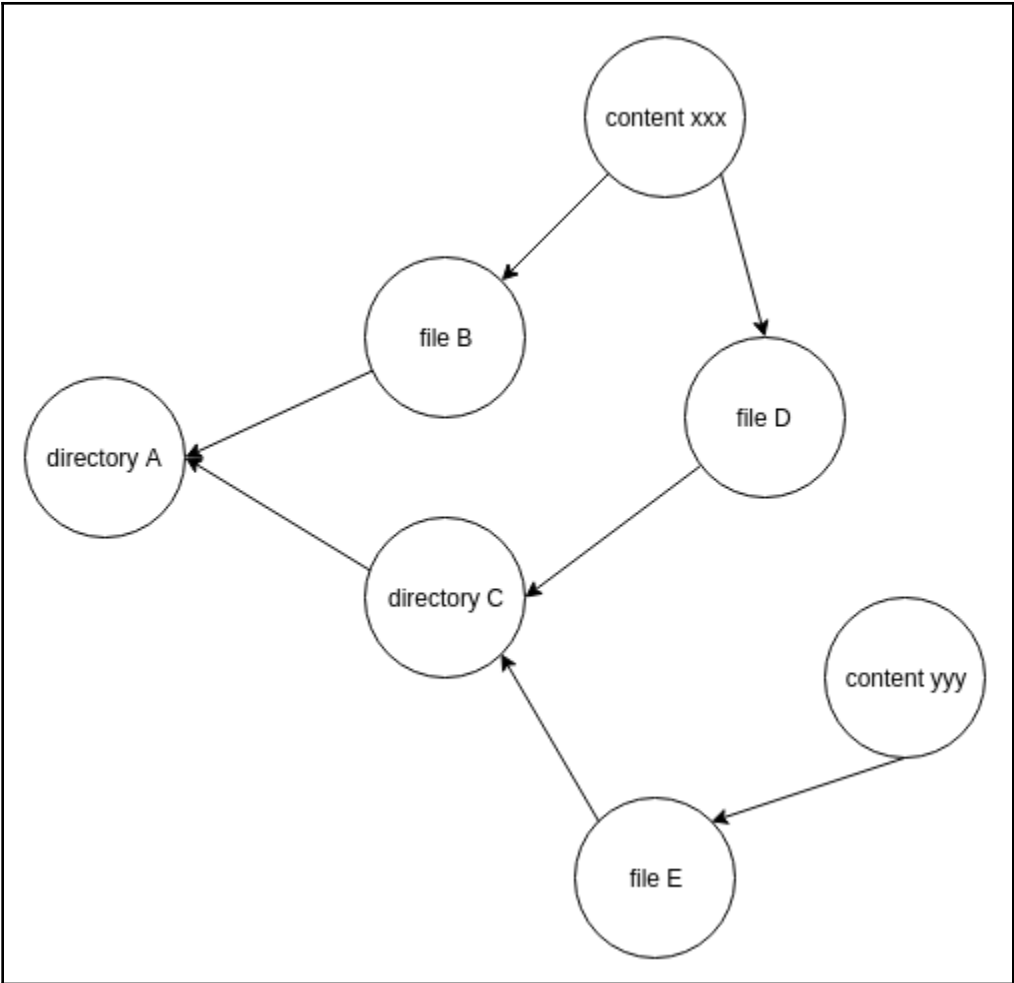

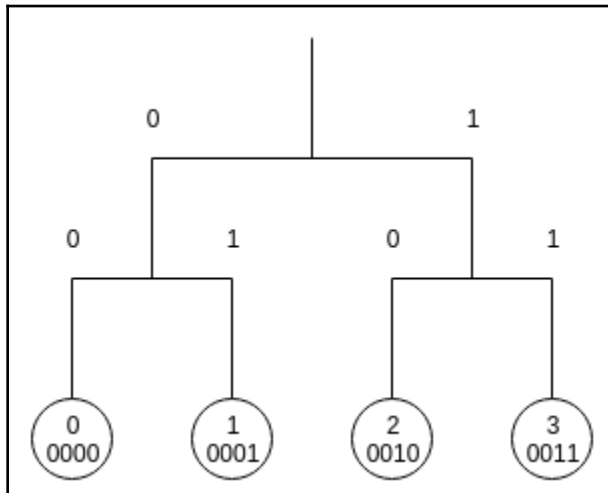
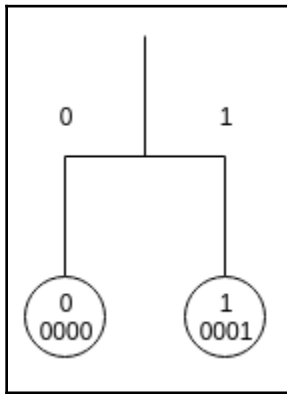
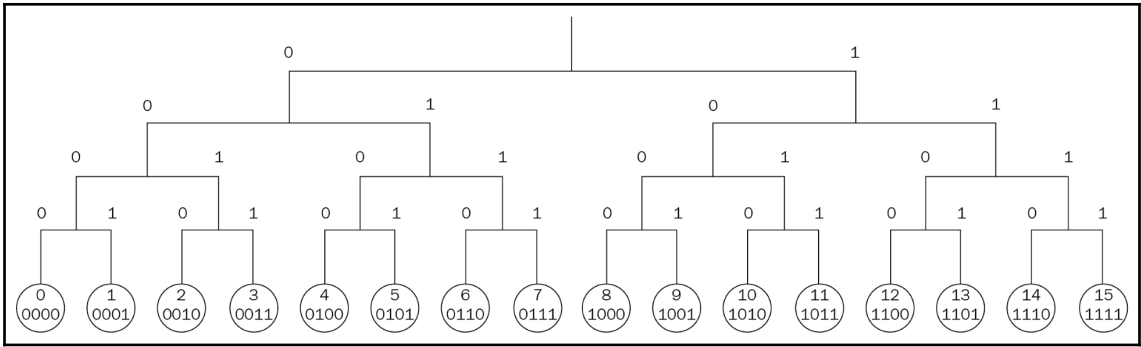

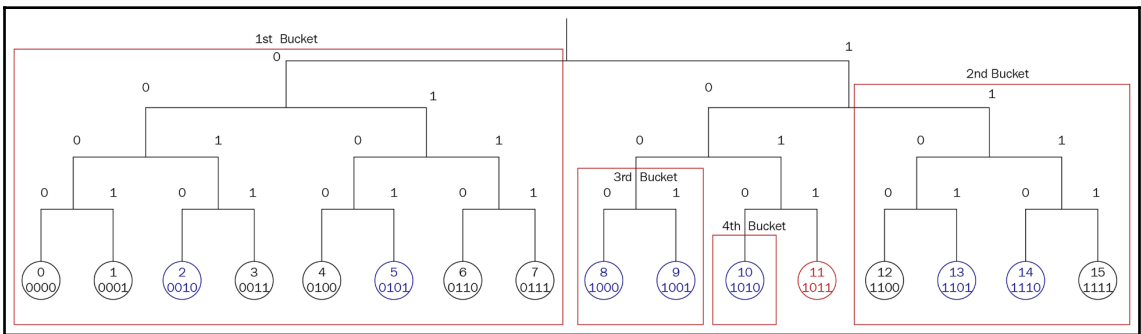
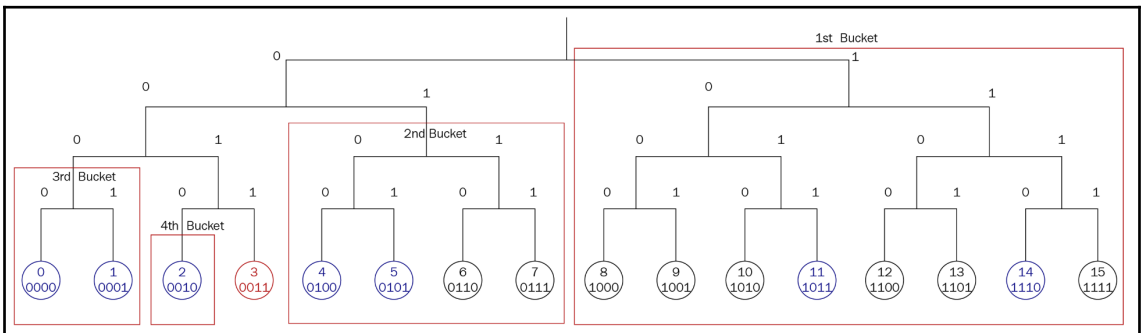
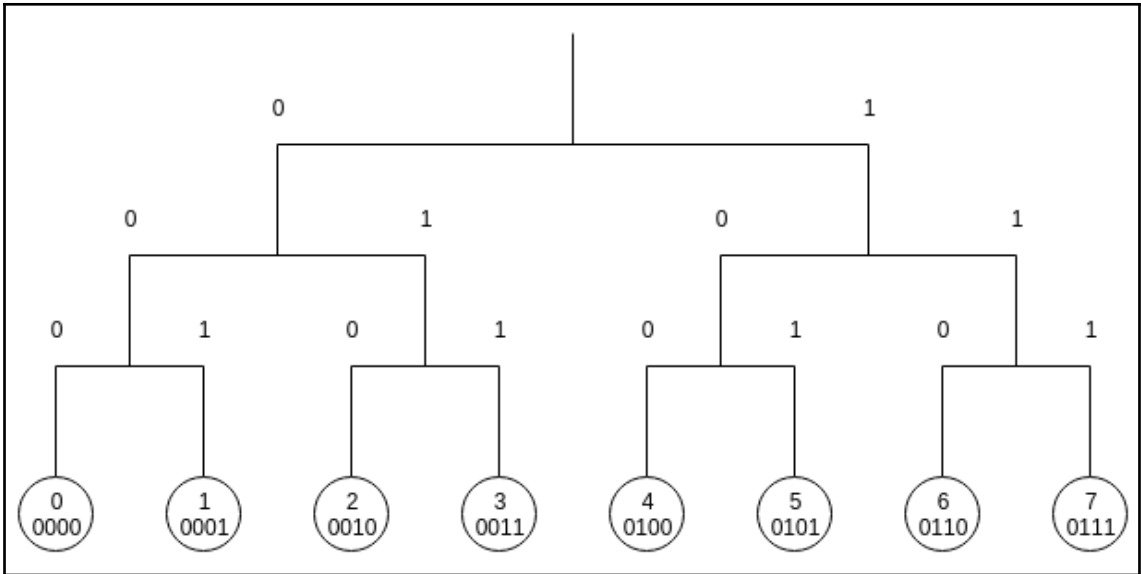

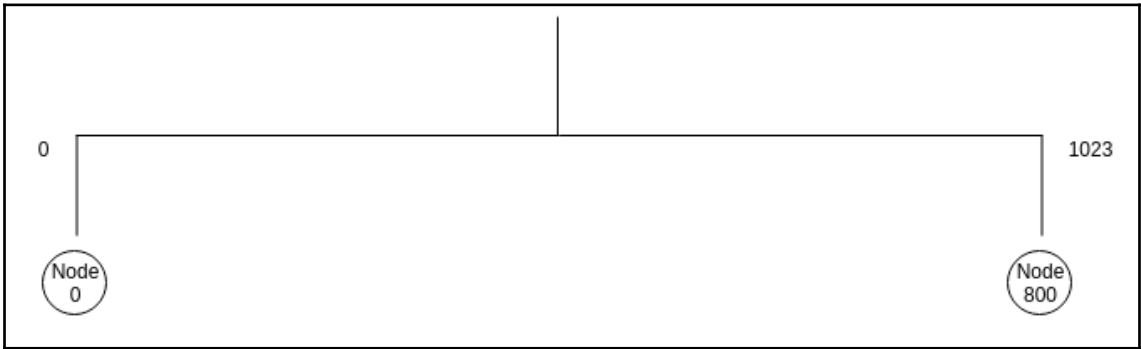
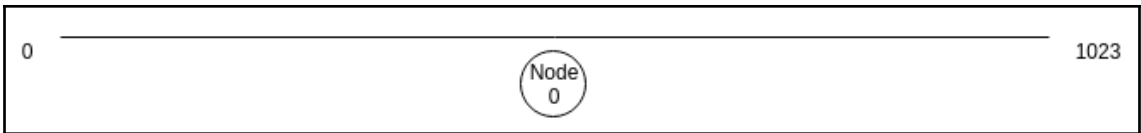
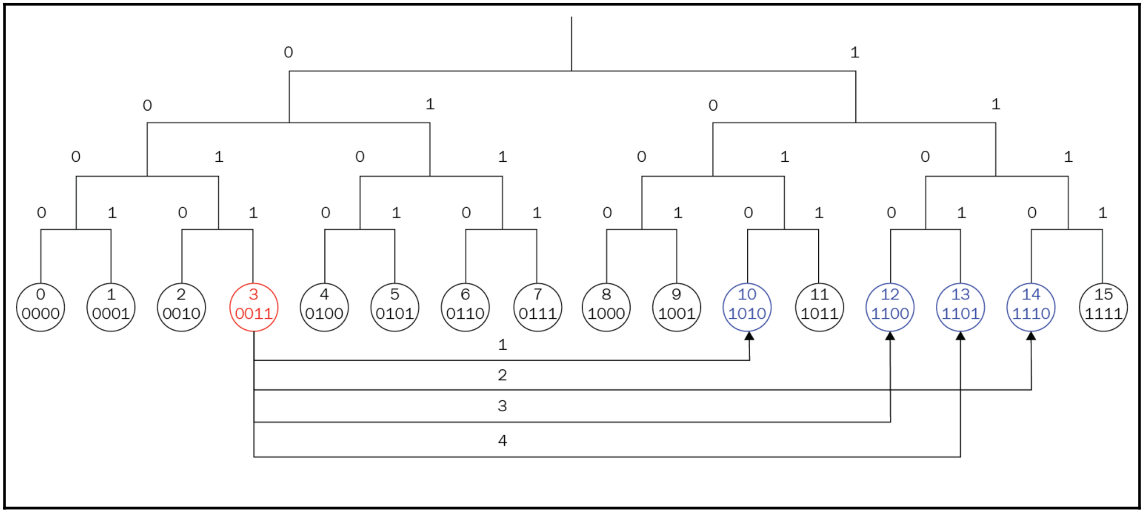

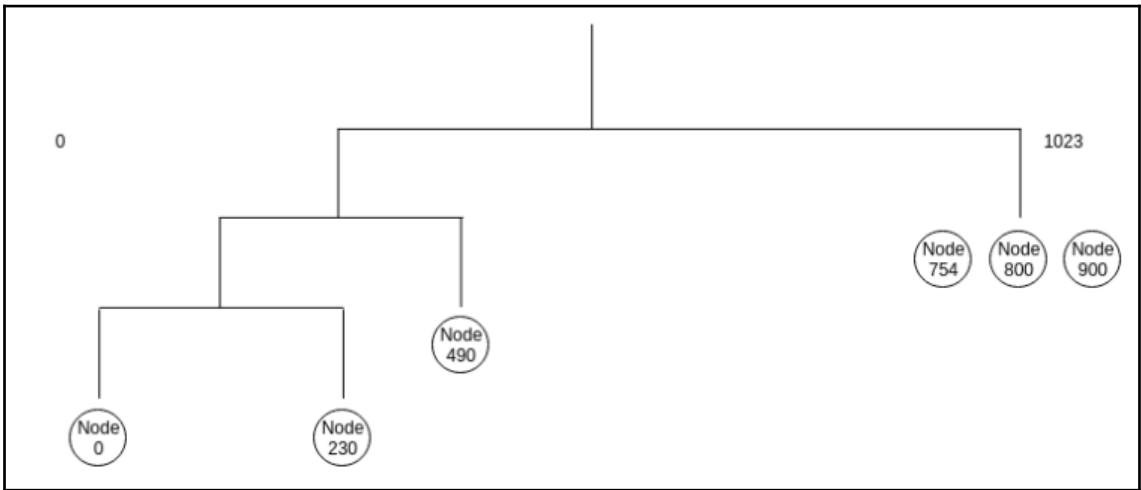
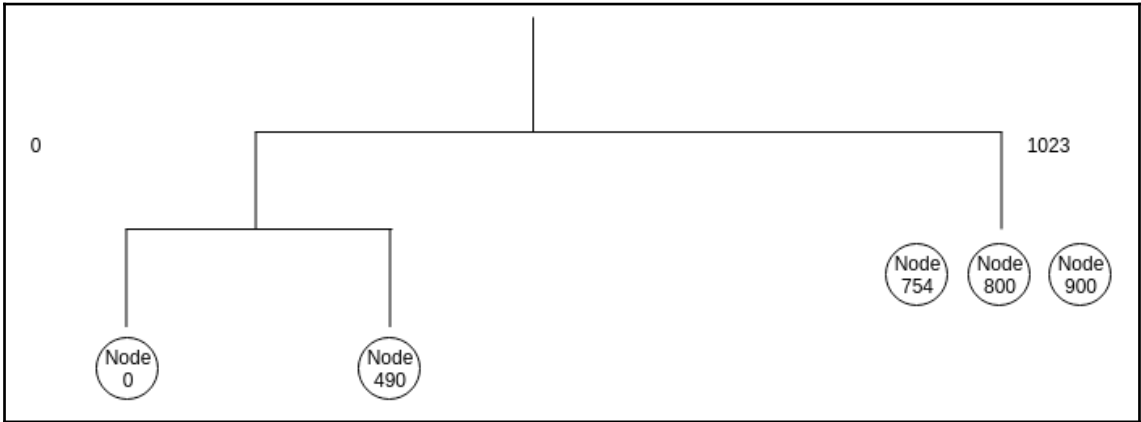
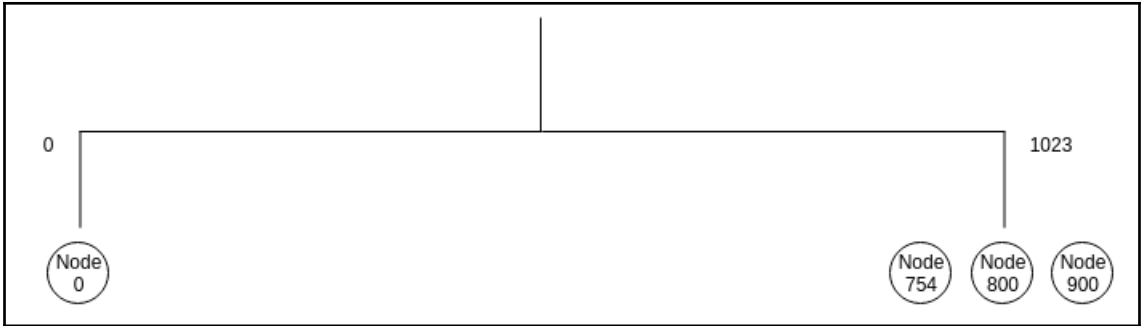

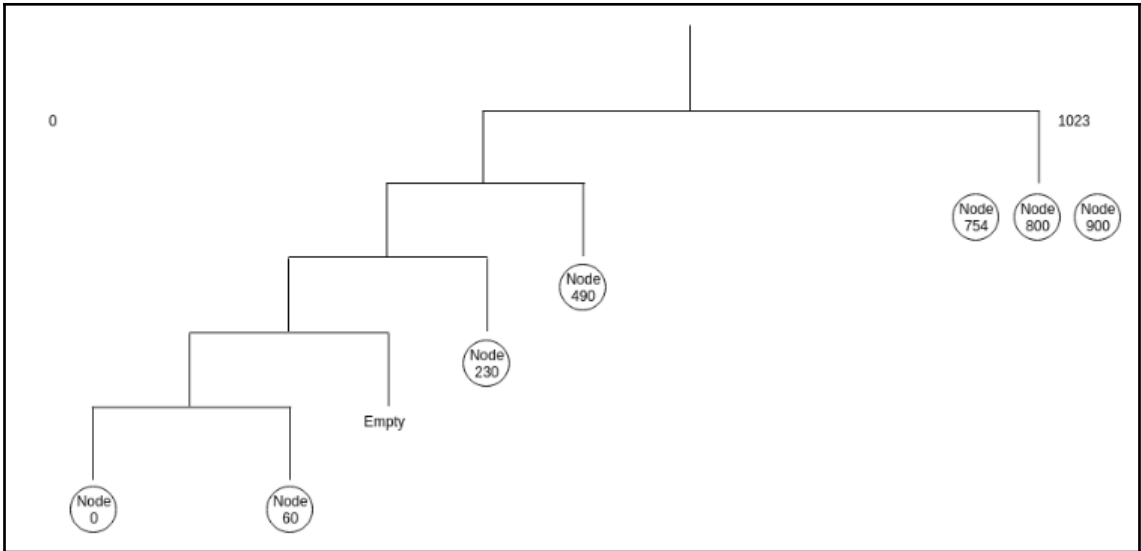

Chapter 16: Using ipfsapi to Interact with IPFS

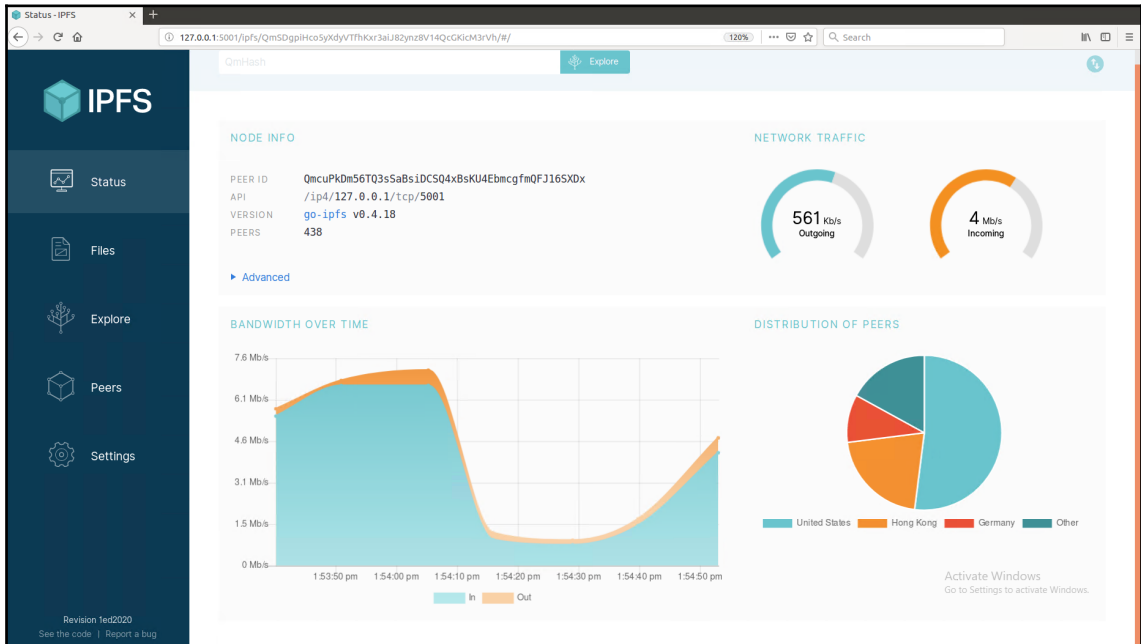

Peers - IPFS

127.0.0.1:5001/ipfs/Qm5DgpiHco5yXdyV1fhKcr3aU8ZynzBV14QcGKicM3rVhJ#/peers

QmHash Explore

IPFS

- Status
- Files
- Explore
- Peers**
- Settings

Revision 1ed2020
See the code | Report a bug

557
PEERS

PEER ID	ADDRESS	LOCATION
Qm25PPH2gptznyGRedHLX3ZzU2LkK15BCyBhSopA0KJNJT	/ip4/1.215.232.107/tcp/4001	Unknown
QmcKnu2PK9EuypG7Bxam1SLU1PgZ0myKFAF9MAd8Ewd	/ip4/1.36.175.232/tcp/39432	Unknown

Activate Windows
Go to Settings to activate Windows.

Settings - IPFS
127.0.0.1:5001/ipfs/QmSdgpHCo5yXdyVTHKr3aJ82yn28V14QcGKicM3rVh/#/settings

IPFS

Status

Files

Explore

Peers

Settings

Revision 1ed2020
See the code | Report a bug

The IPFS config file is a json document. It is read once when the IPFS daemon is started. Save your changes then restart the IPFS daemon to apply them.

Reset
Save

```

1 - {
2   "API": {
3     "HTTPHeaders": {}
4   },
5   "Addresses": {
6     "API": "/ip4/127.0.0.1/tcp/5001",
7     "Announce": [],
8     "Gateway": "/ip4/127.0.0.1/tcp/8080",
9     "NodeAnnounce": [],
10    "Swarm": [
11      "/ip4/0.0.0.0/tcp/4001",
12      "/ip6:::tcp/4001"
13    ]
14  },
15  "Bootstrap": [
16    "/dnsaddr/bootstrap.lbbp2o.lol/ipfs/Qmnoobu7bfJPFotZYWNLWUQ3yrVwbZg5gBHJezGA3N",
17    "/dnsaddr/bootstrap.lbbp2o.lol/ipfs/QmKUDZEPHqAQPR219bChdEONJch1bq51bXJ316619uE1a",
18    "/dnsaddr/bootstrap.lbbp2o.lol/ipfs/QmKdHAR9R9P4KCFE2H1x5gB739K16N8HtP4hQeapJ72Mh",
19    "/dnsaddr/bootstrap.lbbp2o.lol/ipfs/QmC7F59hMk5Xf17cZx8cb34BhtzZ3gU1Z7ZCm5dwt",
20    "/ip4/104.131.131.82/tcp/4001/ipfs/Qmcp0M0v2B6HeYERUeRqWue3N85zUitFmsvQLuvuJ",
21    "/ip4/104.236.179.241/tcp/4001/ipfs/QmSolPppu8tQ5GwKZT2M73ULpJvFd3a26ha46GL1KrGM",
22    "/ip4/178.199.219.111/tcp/4001/ipfs/QmSolSaFTMB8PKadTEgaxCtQVcN8BCNLJ00K1TWKPNu",
23    "/ip4/104.236.76.40/tcp/4001/ipfs/QmSolV48bb51J9cKqDvZPcY3l6sW3DAbzpuFzab564",
24    "/ip4/178.82.158.247/tcp/4001/ipfs/QmSolEr265NRq5p2LA3dPaeykL5136d1FTC88FSuWQKAd",
25    "/ip6/2604:a880:1:20::203:d001/tcp/4001/ipfs/QmSolPppu8tQ5GwKZT2M73ULpJvFd3a26ha46GL1KrGM",
26    "/ip6/2400:0100:0:0d::151:0001/tcp/4001/ipfs/QmSolSaFTMB8PKadTEgaxCtQVcN8BCNLJ00K1TWKPNu",
27    "/ip6/2604:a880:100:101:4a:5001/tcp/4001/ipfs/QmSolV48bb51J9cKqDvZPcY3l6sW3DAbzpuFzab564",
28    "/ip6/2a03:1b0c:0:1010::23:1001/tcp/4001/ipfs/QmSolEr265NRq5p2LA3dPaeykL5136d1FTC88FSuWQKAd"
29  ],
30  "Datastore": {
31    "BloomFilterSize": 0,
32    "GCPeriod": "1h",
33    "HashOnRead": false,
34    "Spec": {
35      "mounts": [
36        {
37          "child": {
38            "path": "blocks",
39            "shardFunc": "/repo/flats/shard/v1/next-to-last/2",
40            "sync": true,
41            "type": "flats"
42          },
43          "mountpoint": "/blocks",
44          "prefix": "flats.datastore",
45          "type": "measure"
46        },
47        {
48          "child": {
49            "compression": "none",
50            "path": "datastore",

```



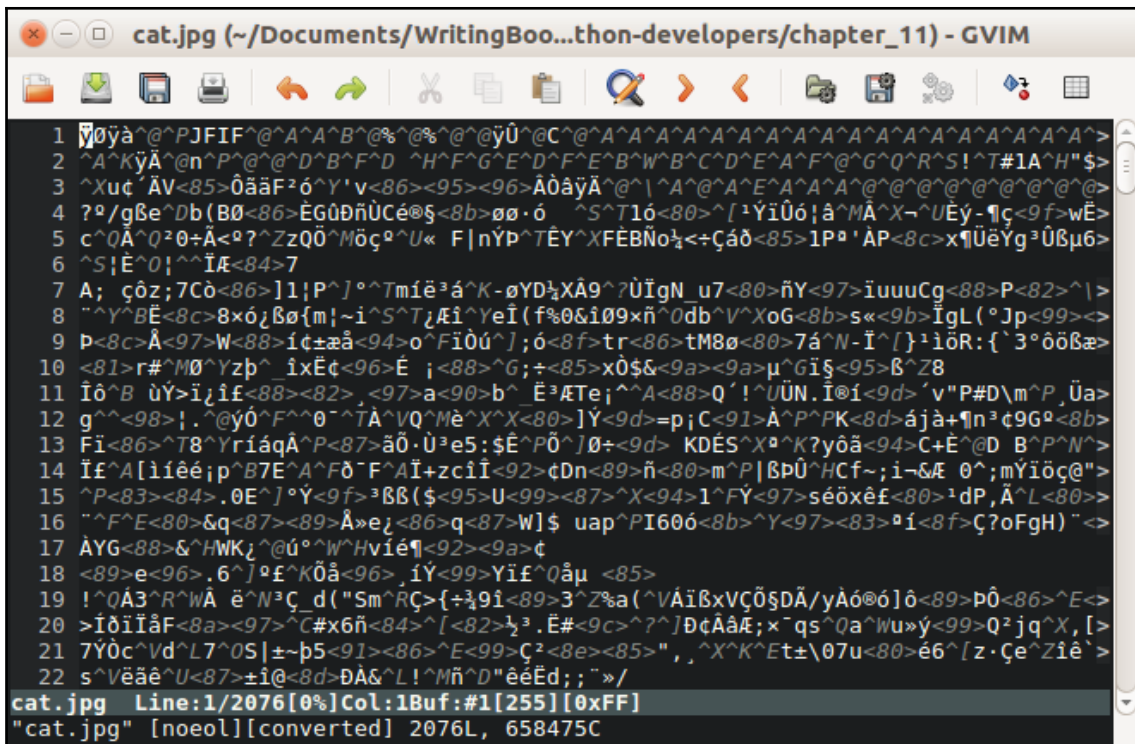

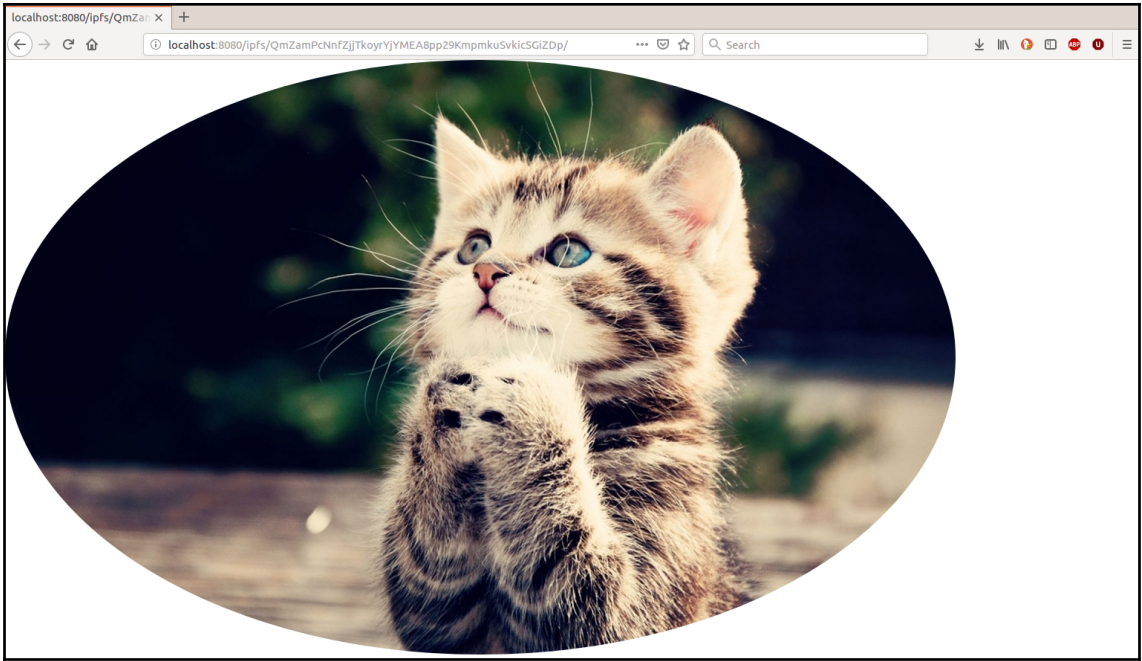











Chapter 17: Implementing a Decentralized Application Using IPFS

Packt Pub Decentralized Videos Sharing Application

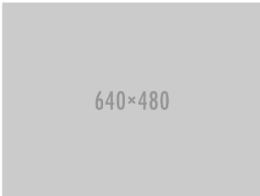
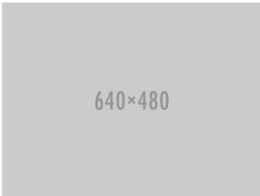
Home Upload

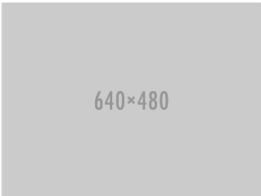
 <p>Bokeh Lights</p>	 <p>Bokeh Lights</p>	 <p>Pexels Videos 146085</p>	 <p>Milky Way Glowing At</p>
 <p>Pexels Videos 2573</p>	 <p>640x480</p> <p>Pexels Videos 2880</p>	 <p>Pexels Videos 100393</p>	 <p>640x480</p> <p>Pexels Videos 109366</p>
 <p>640x480</p> <p>Time Lapse Video Of</p>	 <p>640x480</p> <p>Black And White Vide</p>	 <p>Pexels Videos 4642</p>	 <p>640x480</p> <p>Blurred Lights</p>

Packt Pub Decentralized Videos Sharing Application

[Home](#) [Upload](#)

[Home](#) / [Channel](#) / Milky Way Glowing At

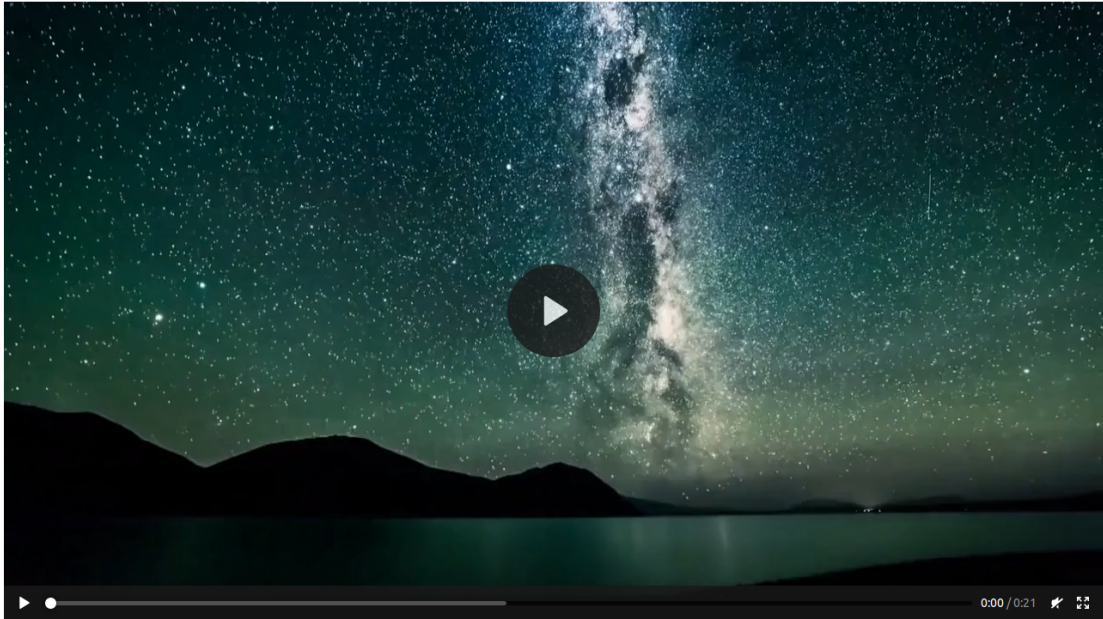

 0

Account

Password

[Like Video!](#)

Packt Pub Decentralized Videos Sharing Application

[Home](#) [Upload](#)

[Home](#) / 0x62551e75104a433f8f318f2cc2a503a9d7343



[Milky Way Glowing At](#)



[Pexels Videos 2573](#)



[Pexels Videos 2880](#)



[Pexels Videos 100393](#)

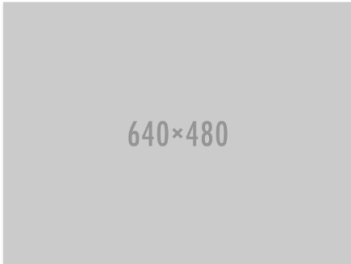

[Pexels Videos 109366](#)



[Time Lapse Video Of](#)

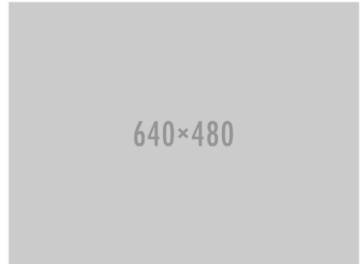

[Black And White Vide](#)

Packt Pub Decentralized Videos Sharing Application

[Home](#) [Upload](#)

[Home](#) / [Uploading Video](#)

Title

Video File



Choose an mp4 video file...

Filename

Account

Password

[Upload Video](#)