

Chapter 1: Getting Started with Azure Implementation

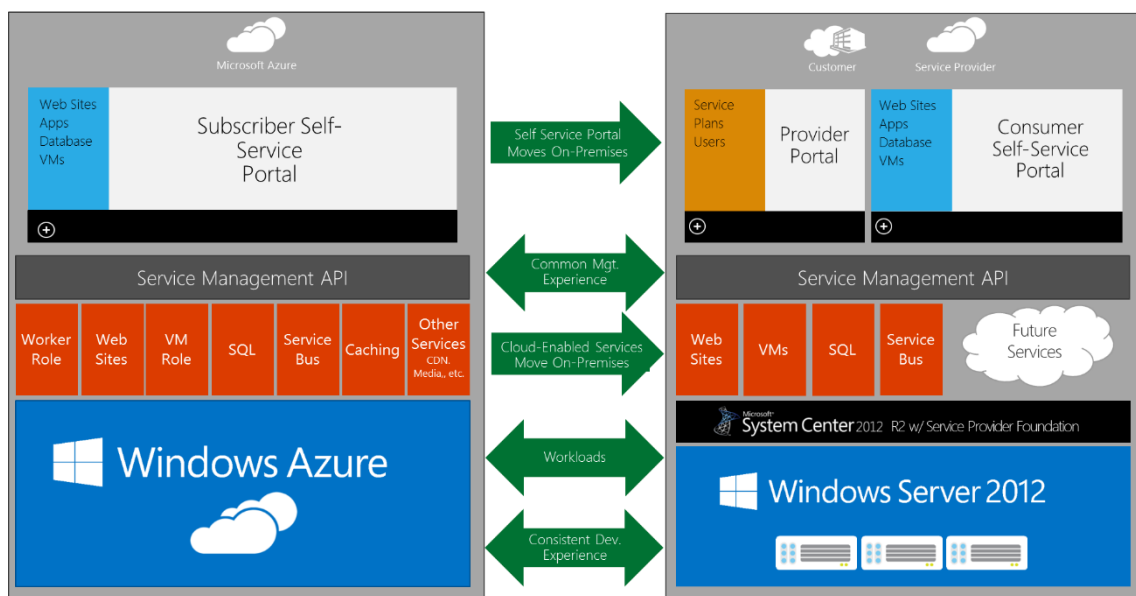

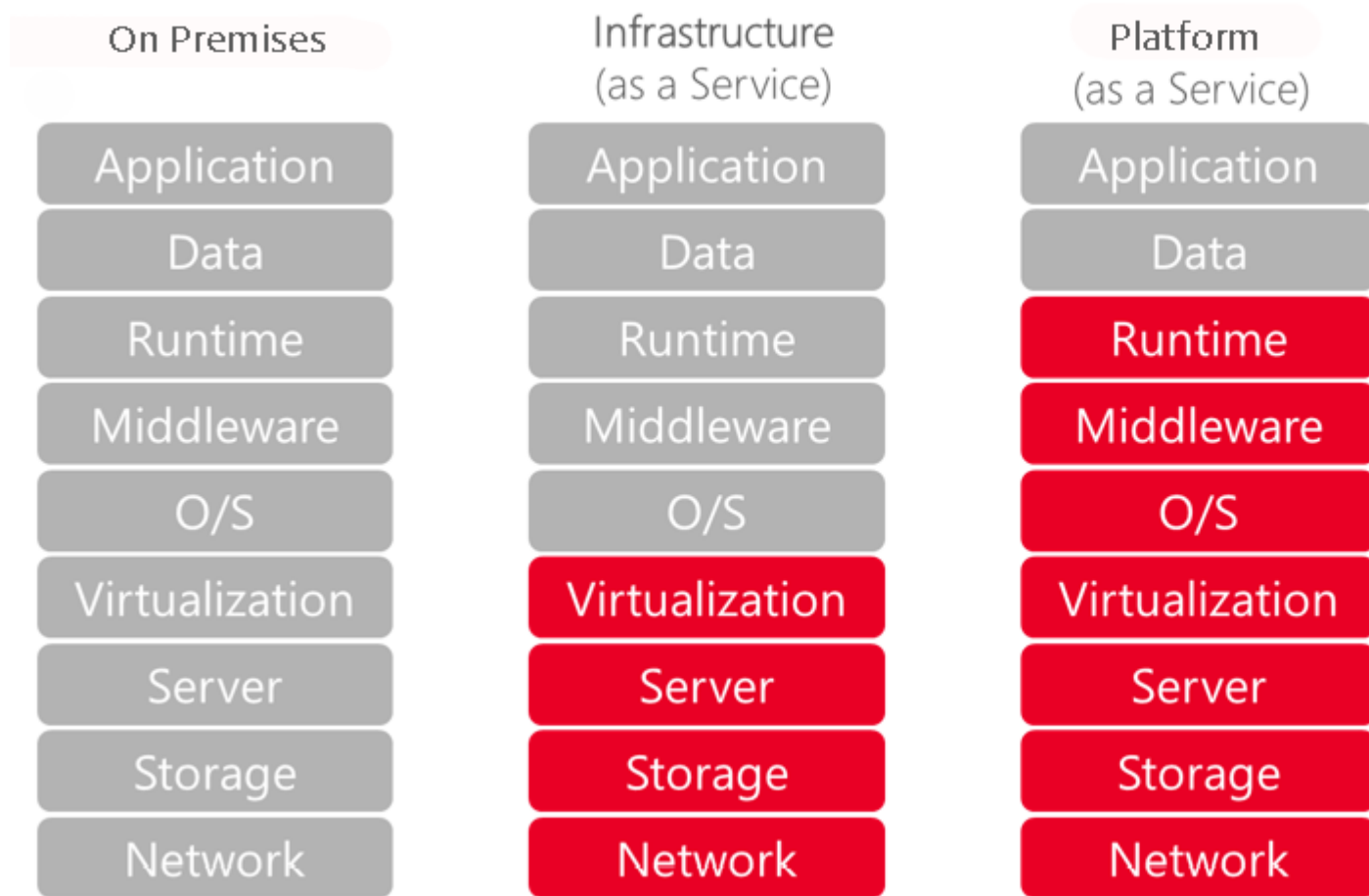
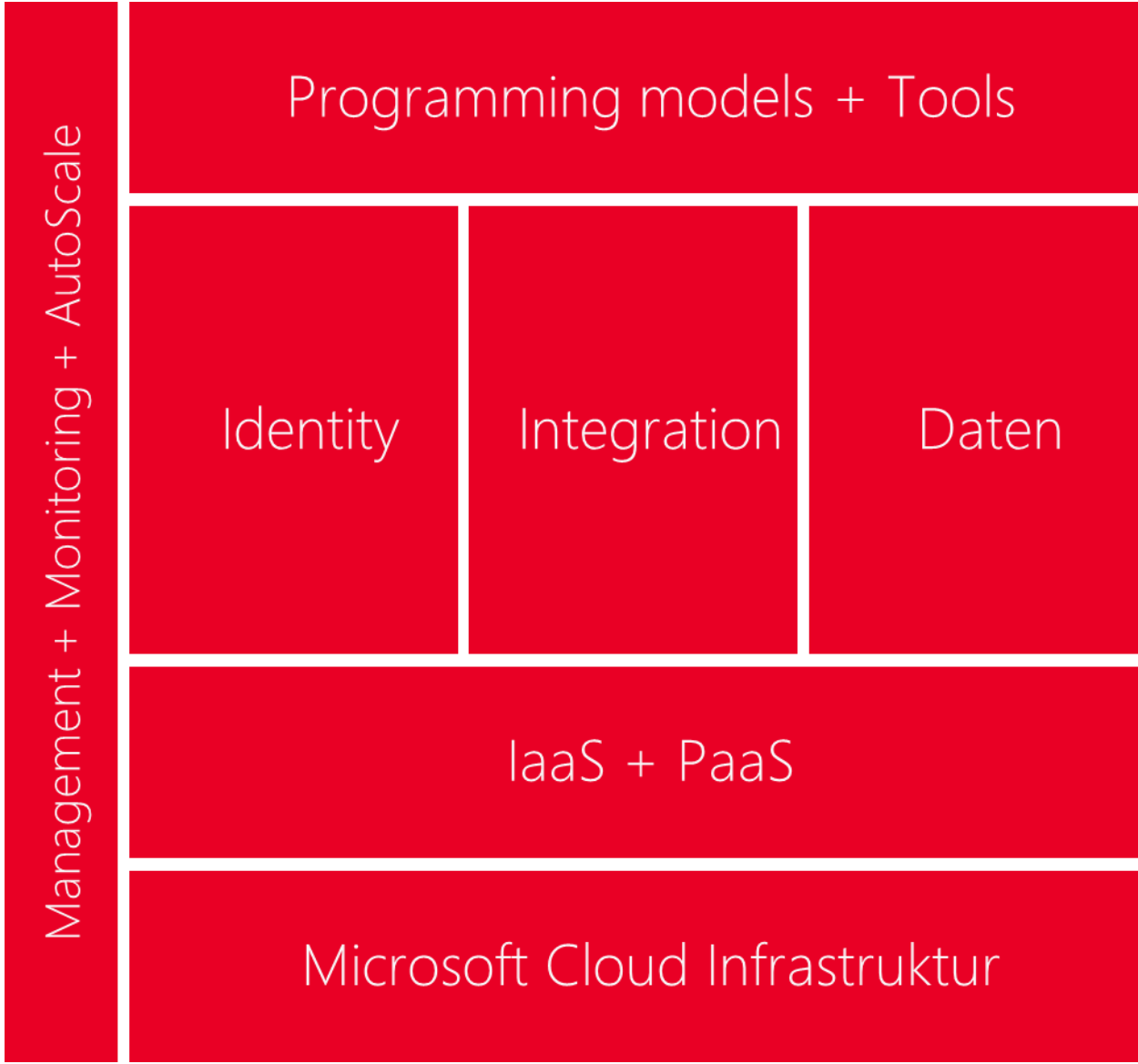

Chapter 2: Azure Resource Manager and Tools

The screenshot displays the Microsoft Azure portal interface. On the left, the navigation pane includes a search bar for resources, a 'New' button, and a list of resource categories. The 'Resource groups' category is highlighted with a red rectangular border. Below this are options for 'All resources', 'Recent', 'App Services', 'Virtual machines (classic)', 'Virtual machines', 'SQL databases', 'Cloud services (classic)', 'Security Center', and 'Subscriptions'. A 'Browse >' link is at the bottom of the navigation pane.

The main dashboard area is titled 'Dashboard' and includes options for '+ New dashboard', 'Edit dashboard', and 'Share'. It is divided into two main sections:

- All resources (ALL SUBSCRIPTIONS):** A vertical list of resource groups, each with an icon and a name: `acdiotthdev`, `acdappservplan`, `acddemoportal`, `acddemoportal`, `Dtlacctestlab`, `acdtestlab`, `acdtest`, `acddevstor`, and `acdcsiotdemo`. A three-dot menu is visible at the bottom of this list.
- Service health (MY RESOURCES):** A world map showing the global distribution of resources. Several green checkmarks are overlaid on the map, indicating the health status of resources in various regions.



+ New

Resource groups

All resources

Recent

App Services

Virtual machines (classic)

Virtual machines

SQL databases

Cloud services (classic)

Security Center

Subscriptions

Browse >

Resource groups

Windows Server User Group Berlin



Add



Columns



Refresh

Subscriptions: Visual Studio Enterprise

NAME



acdappserv



acdcsiotdemo



acddev



acdiotdemo



acdiotdev



acdtestlabRG182808



Default-ServiceBus-NorthEurope



+ New

Resource groups

All resources

Recent

App Services

Virtual machines (classic)

Virtual machines

SQL databases

Cloud services (classic)

Security Center

Subscriptions

Browse >

Resource group

Create an empty resource group

* Resource group name

acdppbook

1

* Subscription

Visual Studio Enterprise

2

* Resource group location

North Europe

3

Pin to dashboard

Create



+ New

Resource groups

All resources

Recent

App Services

Virtual machines (classic)

Virtual machines

SQL databases

Cloud services (classic)

Security Center

Subscriptions

Browse >

Resource groups

Windows Server User Group Berlin



Add



Columns



Refresh

Subscriptions: Visual Studio Enterprise

Filter items...

NAME



acdappserv



acdcsiotdemo



acddev



acdiotdemo



acdiotdev



acdtestlabRG182808



Default-ServiceBus-NorthEurope

✔ Creating

3 ne

The follo
availabil
availabil
data acro



+ New

Resource groups

All resources

Recent

App Services

Virtual machines (classic)

Virtual machines

SQL databases

Cloud services (classic)

Security Center

Subscriptions

Browse >

Resource groups

Windows Server User Group Berlin



Add



Columns



Refresh

Subscriptions: Visual Studio Enterprise

Filter items...

NAME



acdappserv



acdcsiotdemo



acddev



acdiotdemo



acdiotdev



acdppbook



acdtestlabRG182808



Default-ServiceBus-NorthEurope



 New

 Resource groups

 All resources

 Recent

 App Services

 Virtual machines (classic)

 Virtual machines

 SQL databases

 Cloud services (classic)

 Security Center

 Subscriptions

Browse >

New

 *Search the marketplace*

MARKETPLACE

[See all](#)

Virtual Machines >

Web + Mobile >

Data + Storage >

Data + Analytics >

Internet of Things >

Networking >

Media + CDN >

Hybrid Integration >

Security + Identity >

Developer Services >

Management >

Intelligence >

Containers >

Data + Storage

 **SQL Data**
Scalable and
database se
business-cl

 **Data Lake**
Hyper-scale
analytic wo
PREVIEW

 **SQL Data**
Fully elastic
parallelized
Analyze and

 **Azure Doc**
Scalable and
document c
modern clo

 **Storage a**
Use Blobs,
for reliable,
storage.

 **Redis Cac**
Distributed
service for
application



New

Resource groups

All resources

Recent

App Services

Virtual machines (classic)

Virtual machines

SQL databases

Cloud services (classic)

Security Center

Subscriptions

Browse >

Create storage ac...

The cost of your storage account depends on the usage and the options

[Learn more](#)

* Name ⓘ

acdppbookstor



.core.windows.net

Deployment model ⓘ

Resource manager

Classic

Account kind ⓘ

General purpose

Performance ⓘ

Standard

Premium

Replication ⓘ

Read-access geo-redundant storage (RA...

* Subscription ⓘ

Visual Studio Enterprise

* Resource group ⓘ

Create new

Use existing

Pin to dashboard

Create



New

Resource groups

All resources

Recent

App Services

Virtual machines (classic)

Virtual machines

SQL databases

Cloud services (classic)

Security Center

Subscriptions

Browse >

Create storage ac...

The cost of your storage account depends on the usage and the options [Learn more](#)

Resource manager Classic

Account kind ⓘ

General purpose

Performance ⓘ

Standard Premium

Replication ⓘ

Read-access geo-redundant storage (RA...

* Subscription

Visual Studio Enterprise

* Resource group ⓘ

Create new Use existing

|

acdappserv

acdcsiotedemo

acddev

acdioddemo

acdioddev

acdppbook

acdtestlabRG182808

The value should not be empty.



New

Resource groups

All resources

Recent

App Services

Virtual machines (classic)

Virtual machines

SQL databases

Cloud services (classic)

Security Center

Subscriptions

Browse >

Create storage ac...

The cost of your storage account depends on the usage and the options

[Learn more](#)

Resource manager Classic

Account kind ⓘ

General purpose

Performance ⓘ

Standard Premium

Replication ⓘ

Read-access geo-redundant storage (RA...

* Subscription

Visual Studio Enterprise

* Resource group ⓘ

Create new Use existing

acdppbook

* Location

North Europe

Pin to dashboard

Create



New

Resource groups

All resources

Recent

App Services

Virtual machines (classic)

Virtual machines

SQL databases

Cloud services (classic)

Security Center

Subscriptions

Browse >

Dashboard

+ New dashboard

Edit dashboard

Share

All resources
ALL SUBSCRIPTIONS

acdiotthdev

acdappservplan

acddemoportal

acddemoportal

Dtlacctestlab

acdtestlab

acdtest

acddevstor

acdcsiotdemo

Service health
MY RESOURCES





+ New

Resource groups

All resources

Recent

App Services

Virtual machines (classic)

Virtual machines

SQL databases

Cloud services (classic)

Security Center

Subscriptions

Browse >

Resource groups

Windows Server User Group Berlin

+ Add Columns Refresh

Subscriptions: Visual Studio Enterprise

NAME

acdappserv

acdcstotdemo

acddev

acdiotdemo

acdiotdev

acdppbook

acdtestlabRG182808

Default-ServiceBus-NorthEurope



Search (Ctrl+/)

Overview

Activity log

Access control (IAM)

Tags

SETTINGS

Quickstart

Resource costs

Deployments

Properties

Locks

Automation script

MONITORING

Metrics

+ Add

Columns

Delete

Refresh

More

Essentials ^

Subscription name (change)
Visual Studio Enterprise

Subscription ID
02f13438-c22

Deployments
3 Succeeded

Location
North Europe

2 items

NAME

TYPE

acdppbookcs

Cloud service (c

acdppbookstor

Storage account



+ New

Resource groups

All resources

Recent

App Services

Virtual machines (classic)

Virtual machines

SQL databases

Cloud services (classic)

Security Center

Subscriptions

Browse >

ACDPPBOOK

SETTINGS

RESOURCES

Everything



Filter

Search Everything



Users interested in DevTest Labs also viewed





New



MARKETPLACE

[See all](#)

Compute >

Networking >

Storage >

Web + Mobile >

Databases >

Intelligence + analytics >

Internet of Things >

Enterprise Integration >

Security + Identity >

Developer tools >

Monitoring + management >

Add-ons >

Containers >



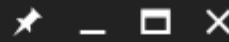

Everything



Delete Refresh Move



Subscription ID
02f13438-c22f-4f1b-ad33-0f9f2eef0ba6
Location
North Europe

TYPE LOCATION

| TYPE | LOCATION | |
|------------------|--------------|-----|
| Cloud service... | North Europe | ... |
| Storage accou... | North Europe | ... |

Filter

Search Everything

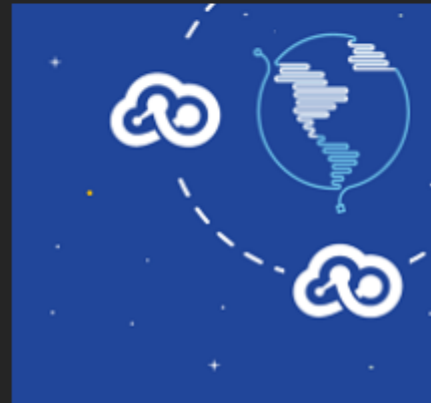

Users interested in Relay also view



Service Bus

Microsoft



Web App

Microsoft





Everything



Filter



Temp|

PrestaShop Advanced Template

Template deployment

Puppet Enterprise 2016.1 Template

Deadline 7 Multi-VM Template

Azure ML Batch Execution Service Web App Template

Azure compute, networking, and storage

Create

Users interested in Template deployment also viewed



Storage account



Windows Server



Virtual network



Load Balancer



Network i



EVERYTHING



Template deployment

Microsoft

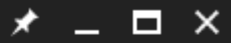

Applications running in Microsoft Azure usually rely on a combination of resources, like databases, servers, and web apps. Azure Resource Manager templates enable you to deploy and manage these resources as a group, using a JSON description of the resources and their deployment settings.

Edit your template with IntelliSense and deploy it to a new or existing resource group.



PUBLISHER Microsoft

LOGICAPPSUPPORTED none

USEFUL LINKS [Documentation](#)

Create



Custom deployment

Deploy from a custom template



TEMPLATE



Template has no resources. Edit the template to add resources.

Edit



Pin to dashboard

Purchase





Edit template

Edit your Azure Resource Manager template

+ Add resource

↑ Quickstart tem...

↓ Download

⚙ Parameters (0)

📄 Variables (0)

📦 Resources (0)

```
1 {  
2   "$schema": "https://schema.management.  
3   "contentVersion": "1.0.0.0",  
4   "parameters": {},  
5   "resources": []  
6 }
```

Save

Discard





Edit template

Edit your Azure Resource Manager template

+ Add resource

↑ Quickstart tem...

↓ Download



Add a resource to the template

* Select a resource

- App Service plan (server farm)
- Availability set
- MySQL database
- SQL database
- SQL server
- Storage account
- Ubuntu virtual machine
- Virtual network
- Web app
- Windows virtual machine



Save

Discard





Edit template

Edit your Azure Resource Manager template

+ Add resource

↑ Quickstart tem...

↓ Download

Load a quickstart template

Select a template (disclaimer) ⓘ

- 100-blank-template
- 101-acs-dcos
- 101-acs-kubernetes
- 101-acs-swarm
- 101-app-service-certificate-standard
- 101-app-service-certificate-wildcard
- 101-application-gateway-create

Save

Discard



Edit template

Edit your Azure Resource Manager template

+ Add resource

↑ Quickstart tem...

↓ Download



Add a resource to the template

* Select a resource

Storage account



Creates a storage account.

* Name: ⓘ

acdsademo

OK

Cancel

Save

Discard





Edit template

Edit your Azure Resource Manager template

+ Add resource ↑ Quickstart tem... ↓ Download

▶ Parameters (1)

▶ Variables (1)

▼ Resources (1)

acdsademo (Microsoft.Storage/st...

```
1 {
2   "$schema": "https://schema.management.azure.com/schemas/2015-01-01/azureResourceManagement.json",
3   "contentVersion": "1.0.0.0",
4   "parameters": {
5     "acdsademoType": {
6       "type": "string",
7       "defaultValue": "Standard_LRS",
8       "allowedValues": [
9         "Standard_LRS",
10        "Standard_ZRS",
11        "Standard_GRS",
12        "Standard_RAGRS",
13        "Premium_LRS"
14      ]
15    }
16  },
17  "resources": [
18    {
19      "name": "[variables('acdsademoType')]",
20      "type": "Microsoft.Storage/storageAccounts",
21      "location": "[resourceGroup().location]",
22      "apiVersion": "2015-06-15",
23      "dependsOn": [],
24      "tags": {
```

Save

Discard





Edit template

Edit your Azure Resource Manager template

+ Add resource

↑ Quickstart tem...

↓ Download

▶ Parameters (1)

▶ Variables (1)

▼ Resources (1)

acdsademo (Microsoft.Storage/st...

```
1 {
2   "$schema": "https://schema.management.azure.com/schemas/2015-01-01/azureResourceManagement.json",
3   "contentVersion": "1.0.0.0",
4   "parameters": {
5     "acdsademoType": {
6       "type": "string",
7       "defaultValue": "Standard_LRS",
8       "allowedValues": [
9         "Standard_LRS",
10        "Standard_ZRS",
11        "Standard_GRS",
12        "Standard_RAGRS",
13        "Premium_LRS"
14      ]
15    }
16  },
17  "resources": [
18    {
19      "name": "[variables('acdsademoType')]",
20      "type": "Microsoft.Storage/storageAccounts",
21      "location": "[resourceGroup().location]",
22      "apiVersion": "2015-06-15",
23      "dependsOn": [],
24      "tags": {}
25    }
26  ]
27 }
```

Save

Discard

Möchten Sie „template.json“ (1,02 KB) von „portal.azure.com“ öffnen oder speichern?



Edit template

Edit your Azure Resource Manager template

+ Add resource ↑ Quickstart tem... ↓ Download



▶ Parameters (1)



▶ Variables (1)



▼ Resources (1)



acdsademo (Microsoft.Storage/st...



```
1 {
2   "$schema": "https://schema.management.azure.com/schemas/2015-01-01/azureResourceManagement.json",
3   "contentVersion": "1.0.0.0",
4   "parameters": {
5     "acdsademoType": {
6       "type": "string",
7       "defaultValue": "Standard_LRS",
8       "allowedValues": [
9         "Standard_LRS",
10        "Standard_ZRS",
11        "Standard_GRS",
12        "Standard_RAGRS",
13        "Premium_LRS"
14      ]
15    }
16  },
17  "resources": [
18    {
19      "name": "[variables('acdsademoType')]",
20      "type": "Microsoft.Storage/storageAccounts",
21      "location": "[resourceGroup().location]",
22      "apiVersion": "2015-06-15",
23      "dependsOn": [],
24      "tags": {
```

Save Discard



Custom deployment

Deploy from a custom template

TEMPLATE



Customized template

1 resource



Edit

BASICS

* Subscription

Visual Studio Enterprise

* Resource group ⓘ

Create new Use existing

* Location

North Europe

SETTINGS

Acdsademo Type

Standard_LRS

TERMS AND CONDITIONS

Pin to dashboard

Purchase





Custom deployment

Deploy from a custom template



* Subscription

Visual Studio Enterprise

* Resource group

Create new Use existing

acdbbooktest

* Location

North Europe

SETTINGS

Acadsademo Type

Standard_LRS

Standard_ZRS

Standard_GRS

Standard_RAGRS

Premium_LRS

TERMS AND CONDITIONS

[Azure Marketplace Terms](#) | [Azure Marketplace](#)

By clicking "Purchase," I (a) agree to the applicable legal terms associated with the offering; (b) authorize Microsoft to bill my current payment method for the fees associated with the offering(s), including applicable taxes, with the same frequency as my Azure subscription, until I discontinue use of the offering(s); and (c) agree that, if the deployment includes third-party offerings, Microsoft may share my contact information and other details of such deployment with the publisher of such offerings.

Pin to dashboard

Purchase





Custom deployment

Deploy from a custom template



← Create new → Use existing

acdbooktest

* Location

North Europe

SETTINGS

Acadsademo Type

Standard_LRS

TERMS AND CONDITIONS

[Azure Marketplace Terms](#) | [Azure Marketplace](#)

By clicking "Purchase," I (a) agree to the applicable legal terms associated with the offering; (b) authorize Microsoft bill my current payment method for the fees associated the offering(s), including applicable taxes, with the same b frequency as my Azure subscription, until I discontinue use of the offering(s); and (c) agree that, if the deployment party offerings, Microsoft may share my contact information and other details of such deployment with the publish offering.

I agree to the terms and conditions stated above

Pin to dashboard

Purchase

Microsoft Azure Dashboard

Search resources

Oliver.Michalski@win... WINDOWS SERVER USER GRO...

Dashboard

- All resources ALL SUBSCRIPTIONS
 - acdlothdev
 - acdappservplan
 - acddemoportal
 - acdtestlab
 - acdtestlab
 - acdtest
 - acdtestenvstor
 - acdtestdemo
- Service health MY RESOURCES
- Resources ACIDOTDEV
- Resources ACIDOTDEMO
- Marketplace
- Help + support

Microsoft Azure Resource groups

Resource groups

Windows Server User Group Berlin

Subscriptions: Visual Studio Enterprise

| NAME | SUBSCRIPTION | LOCATION | |
|--------------------------------|--------------------------|--------------|-----|
| acdappserv | Visual Studio Enterprise | West US | ... |
| acdtestdemo | Visual Studio Enterprise | North Europe | ... |
| acddev | Visual Studio Enterprise | North Europe | ... |
| acdtestdemo | Visual Studio Enterprise | North Europe | ... |
| acdtestdev | Visual Studio Enterprise | North Europe | ... |
| acdppbook | Visual Studio Enterprise | North Europe | ... |
| acdtestlab-RG18Z808 | Visual Studio Enterprise | North Europe | ... |
| Default-ServiceBus-NorthEurope | Visual Studio Enterprise | North Europe | ... |



Search (Ctrl+/)

Overview

Activity log

Access control (IAM)

Tags

SETTINGS

Quickstart

Resource costs

Deployments

Properties

Locks

Automation script

MONITORING

Metrics

+ Add Columns Delete Refresh Mo

Essentials ^

Subscription name (change)
Visual Studio Enterprise
Subscriptions ID
02f13438-c22
Deployments
3 Succeeded
Location
North Europe

2 items

| NAME | TYPE |
|---------------|------------------|
| acdppbookcs | Cloud service (c |
| acdppbookstor | Storage account |



acdppbook - Tags

Resource group



Search (Ctrl+/)

Overview

Activity log

Access control (IAM)

Tags

SETTINGS

Quickstart

Resource costs

Deployments

Properties

Locks

Automation script

MONITORING



Tags are key/value pairs that enable you to categorize resources and consolidate billing by applying the same tag to multiple resource groups. [Learn more](#)

* Key

* Value

Name

ppbook

No tags



Search (Ctrl+/)

Overview

Activity log

Access control (IAM)

Tags

SETTINGS

Quickstart

Resource costs

Deployments

Properties

Locks

Automation script

MONITORING

Metrics

+ Add Columns Delete Refresh Mo

Essentials ^

Subscription name (change)
Visual Studio Enterprise
Subscription ID
02f13438-c22
Deployments
3 Succeeded
Location
North Europe

2 items

| NAME | TYPE |
|---------------|------------------|
| acdppbookcs | Cloud service (c |
| acdppbookstor | Storage account |



acdppbookstor

Storage account

Search (Ctrl+/)

Overview

Activity log

Access control (IAM)

Tags

Diagnose and solve problems

SETTINGS

Access keys

Configuration

Shared access signature

Properties

Locks

Automation script

Open in Explorer

Delete

Essentials

Resource group (change)

acdppbook

Status

Primary: Available, Secondary: Available

Location

North Europe, West Europe

Subscription name (change)

Visual Studio Enterprise

Subscription ID

02f13438-c22f-4f1b-ad33-0f9f2eef0ba6

Services



Blobs



Files

Monitoring

Total requests



acdppbookstor - Tags

Storage account

Search (Ctrl+/)

- Overview
- Activity log
- Access control (IAM)
- Tags**
- Diagnose and solve problems
- SETTINGS
 - Access keys
 - Configuration
 - Shared access signature
 - Properties
 - Locks
 - Automation script

Save



Tags are key/value pairs that enable you to consolidate billing by applying the same tag groups. [Learn more](#)

| * Key | * Value |
|-------|---------|
| Name | ppbo |

No tags



New

Recent

App Services

Virtual machines (classic)

Virtual machines

SQL databases

Cloud services (classic)

Security Center

Subscriptions

Azure Active Directory

Monitor

Billing

Help + support

More services >

Filter

By category

Crypteron

Import/export jobs

Mailjet Email Service

Marketplace

Recent

Resource Explorer

Service health

SQL elastic job accounts

Tags

Templates

What's new

PREVIEW

[Help improve the service menu!](#)



Tags

Windows Server User Group Berlin

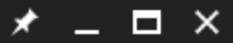

Subscriptions: Visual Studio Enterprise – Don't see a subscription? [Switch directories](#)



Tags are key/value pairs that enable you to categorize resources and view consolidated billing by applying the same tag to multiple resources and resource groups. [Learn more](#)



displayName : acdsademo



Name : ppbook





RESOURCE GROUPS



acdppbook - Tags

Resource group

Search (Ctrl+/)



Overview



Activity log



Access control (IAM)



Tags

SETTINGS



Quickstart



Resource costs



Deployments



Properties



Locks



Automation script

MONITORING

Save



Tags are key/value pairs that enable you to consolidate billing by applying the same tag groups. [Learn more](#)

* Key

* Value

Name : ppbook



New

Resource groups

All resources

Recent

App Services

Virtual machines (classic)

Virtual machines

SQL databases

Cloud services (classic)

Security Center

Subscriptions

Browse

Dashboard

+ New dashboard

Edit dashboard

Share

All resources
ALL SUBSCRIPTIONS

acdiotthdev

acdappservplan

acddemoportal

acddemoportal

Dtlacdtestlab

acdtestlab

acdtest

acddevstor

acdcsiotdemo

Service health
MY RESOURCES





+ New

Resource groups

All resources

Recent

App Services

Virtual machines (classic)

Virtual machines

SQL databases

Cloud services (classic)

Security Center

Subscriptions

Browse >

Resource groups

Windows Server User Group Berlin

+ Add Columns Refresh

Subscriptions: Visual Studio Enterprise

NAME

acdappserv

acdcstotdemo

acddev

acdiotdemo

acdiotdev

acdppbook

acdtestlabRG182808

Default-ServiceBus-NorthEurope



Search (Ctrl+/)

Overview

Activity log

Access control (IAM)

Tags

SETTINGS

Quickstart

Resource costs

Deployments

Properties

Locks

Automation script

MONITORING

Metrics

+ Add Columns Delete Refresh Mo

Essentials ^

Subscription name (change)
Visual Studio Enterprise
Subscription ID
02f13438-c22
Deployments
3 Succeeded
Location
North Europe

2 items

| NAME | TYPE |
|---------------|------------------|
| acdppbookcs | Cloud service (c |
| acdppbookstor | Storage account |

RESOURCE GROUPS

- +
- 📦
- 📊
- 🕒
- 🌐
- 🖥️
- 🖥️
- 🗄️
- ⚙️
- 🛡️
- 🔑
- 📏
- 🌐
- 📊

acdppbook - Locks

Resource group

🔍 Search (Ctrl+/)

- 📦 Overview
- 📄 Activity log
- 👤 Access control (IAM)
- 🏷️ Tags
- SETTINGS
- 👉 Quickstart
- 💰 Resource costs
- 🏠 Deployments
- ☰ Properties
- 🔒 Locks
- 📄 Automation script
- MONITORING

+ Add 🔒 Subscription 🔄 Refresh

| LOCK NAME | LOCK TYPE | SCOPE | NOTES |
|-----------|-----------|-------|-------|
|-----------|-----------|-------|-------|

This resource has no locks.



RESOURCE GROUPS



acdppbook - Locks

Resource group

Search (Ctrl+/)



Overview



Activity log



Access control (IAM)



Tags

SETTINGS



Quickstart



Resource costs



Deployments



Properties



Locks



Automation script

MONITORING

+ Add



Subscription



Refresh

Add lock

Lock name

ppbookdemo



Lock type

Read-only

Delete

Notes

OK

Cancel



RESOURCE EXPLORER

acdppbookstor

Storage account

Search (Ctrl+/)

- Overview
- Activity log
- Access control (IAM)
- Tags
- Diagnose and solve problems
- SETTINGS
 - Access keys
 - Configuration
 - Shared access signature
 - Properties
 - Locks
 - Automation script

Open in Explorer Delete

This storage account has a read-only lock. Full control is disabled.

Essentials

Resource group (change) **acdppbook**
Status Primary: Available, Secondary: Available
Location North Europe, West Europe
Subscription name (change) **Visual Studio Enterprise**
Subscription ID 02f13438-c22f-4f1b-ad33-0f9f2eef0ba6

Services

Blobs Files

Monitoring

Total requests



New

Resource groups

All resources

Recent

App Services

Virtual machines (classic)

Virtual machines

SQL databases

Cloud services (classic)

Security Center

Subscriptions

Browse >

Dashboard

+ New dashboard

Edit dashboard

Share

All resources
ALL SUBSCRIPTIONS

acdiotthdev

acdappservplan

acddemoportal

acddemoportal

Dtlacctestlab

acdtestlab

acdtest

acddevstor

acdcsiotdemo

Service health
MY RESOURCES





+ New

Resource groups

All resources

Recent

App Services

Virtual machines (classic)

Virtual machines

SQL databases

Cloud services (classic)

Security Center

Subscriptions

Browse >

Resource groups

Windows Server User Group Berlin

+ Add Columns Refresh

Subscriptions: Visual Studio Enterprise

NAME

acdappserv

acdcsiotdemo

acddev

acdiotdemo

acdiotdev

acdppbook

acdtestlabRG182808

Default-ServiceBus-NorthEurope



RESOURCE GROUPS

acdppbook Resource group

Search (Ctrl+/)

- Overview
- Activity log
- Access control (IAM)
- Tags
- SETTINGS
 - Quickstart
 - Resource costs
 - Deployments
 - Properties
 - Locks
 - Automation script
- MONITORING

+ Add Columns Delete Refresh

Essentials ^

Subscription name (change)
Visual Studio Enterprise
Deployments
3 Succeeded

2 items

| NAME |
|---------------|
| acdppbookes |
| acdppbookstor |



RESOURCE GROUPS



acdppbook - Automation script

Resource group - PREVIEW

Download

Add to library

Deploy

- Overview
- Activity log
- Access control (IAM)
- Tags
- SETTINGS
- Quickstart
- Resource costs
- Deployments
- Properties
- Locks
- Automation script**
- MONITORING

Classic resources cannot be exported and have...



Automate deploying resources with Azure Resource Manager and deploy with script or code. [Learn more about...](#)

Template Parameters CLI PowerShell .NET

- Parameters (1) 1
- Variables (0) 2
- Resources (1) 3
 - [parameters('storageAccounts_acd...') 4

5
6
7
8
9
10
11
12
13
14



RESOURCE GROUPS



acdppbook - Automation script

Resource group - PREVIEW

Download Add to library Deploy

Search (Ctrl+/)

- Overview
- Activity log
- Access control (IAM)
- Tags

SETTINGS

- Quickstart
- Resource costs
- Deployments
- Properties
- Locks
- Automation script

MONITORING

Classic resources cannot be exported and have...



Automate deploying resources with Azure Re... and deploy with script or code. [Learn more ab...](#)

Template Parameters CLI PowerShell .NET

- Parameters (1)
- Variables (0)
- Resources (1)
 - [parameters('storageAccounts_acd...]



RESOURCE GROUPS



acdppbook
Resource group

Search (Ctrl+/)

- Overview
- Activity log
- Access control (IAM)
- Tags
- SETTINGS
- Quickstart
- Resource costs
- Deployments
- Properties
- Locks
- Automation script
- MONITORING

+ Add Columns Delete Refresh

Essentials ^

Subscription name (change)
Visual Studio Enterprise

Deployments
3 Succeeded

2 items

NAME v

- acdppbookes
- acdppbookstor



RESOURCE GROUPS



Deployment hi... acdppbook



Microsoft.Template
11/29/2016 8:45:22 PM



Microsoft.CloudService
10/9/2016 3:26:59 PM



Microsoft.StorageAccount-2016062315...
7/23/2016 3:21:28 PM

Microsoft.StorageAccount-2

Deployment



Delete



Cancel



Refresh

RESOURCE GROUP

acdpp

RELATED

Even

Outputs

NO DEPLOYMENT OUTPUTS

Inputs

NAME

acd

ACCOUNTTYPE

Sta

LOCATION

non

ENCRYPTIONENABLED

fals

Operation details



RESOURCE



TYPE



acdppbookstor

Microso



Template

Microsoft.StorageAccount-20160623152056

Download Add to library Deploy



Automate deploying resources with Azure Resource Manager templates in a single, coordinated operation. [Learn more.](#)

Template Parameters CLI PowerShell .NET Ruby

- Parameters (4)
- Variables (0)
- Resources (1)
 - [parameters('name')] (Microsoft.St..

```
1 {
2   "$schema": "https://schema.management.azure.com/schemas/2015-01-01/azureResourceManagement.json",
3   "contentVersion": "1.0.0.0",
4   "parameters": {
5     "name": {
6       "type": "String"
7     },
8     "accountType": {
9       "type": "String"
10    },
11    "location": {
12      "type": "String"
13    },
14    "encryptionEnabled": {
15      "defaultValue": false,
16      "type": "Bool"
17    }
18  },
19  "resources": [
```

RESOURCE GROUPS

- +
- Resource group icon
- Grid icon
- Activity log icon
- Access control icon
- Tags icon
- Settings icon
- Quickstart icon
- Resource costs icon
- Deployments icon
- Properties icon
- Locks icon
- Automation script icon
- Monitoring icon

 **acdppbook**
Resource group

- Overview**
- Activity log
- Access control (IAM)
- Tags
- SETTINGS**
- Quickstart
- Resource costs
- Deployments
- Properties
- Locks
- Automation script
- MONITORING**



+ Add Columns Delete Refresh

Essentials ^

Subscription name ([change](#))
Visual Studio Enterprise
Deployments
3 Succeeded

2 items

NAME v

-  **acdppbookes**
-  **acdppbookstor**



acdppbookstor

Storage account

Search (Ctrl+/)

Overview

Activity log

Access control (IAM)

Tags

Diagnose and solve problems

SETTINGS

Access keys

Configuration

Shared access signature

Properties

Locks

Automation script

Open in Explorer

Delete

Essentials

Resource group (change)

acdppbook

Status

Primary: Available, Secondary: Available

Location

North Europe, West Europe

Subscription name (change)

Visual Studio Enterprise

Subscription ID

02f13438-c22f-4f1b-ad33-0f9f2eef0ba6

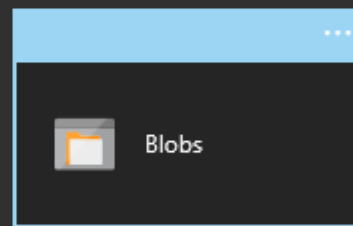

Blobs



Files

Monitoring

Total requests

20

15



acdppbookstor - Automation script

Storage account - PREVIEW

Download Add to library Deploy



Search (Ctrl+/)

- Overview
- Activity log
- Access control (IAM)
- Tags
- Diagnose and solve problems
- SETTINGS
 - Access keys
 - Configuration
 - Shared access signature
 - Properties
 - Locks
 - Automation script

Classic resources cannot be exported and have been



Automate deploying resources with Azure Resource Manager. Learn more about templating and how to

Template Parameters CLI PowerShell .NET

- Parameters (1)
- Variables (0)
- Resources (1)
 - [parameters('storageAccounts_acd...

```
1 {
2   "$
3   "https
4   "p
5
6
7
8
9   }
10  "v
11  "r
12
13
14  '/subs
    /Micro
```



RESOURCE GROUPS



acdppbook - Automation script

Resource group - PREVIEW

Download

Add to library

Deploy

Search (Ctrl+/)



Overview



Activity log



Access control (IAM)



Tags

SETTINGS



Quickstart



Resource costs



Deployments



Properties



Locks



Automation script

MONITORING



Classic resources cannot be exported and have...



Automate deploying resources with Azure Re... and deploy with script or code. [Learn more ab...](#)

Template

Parameters

CLI

PowerShell

.NET

Parameters (1)



Variables (0)



Resources (1)

[parameters('storageAccounts_acd...]

1

2

3

4

5

6

7

8

9

10

11

12

13

14



Custom deployment

Deploy from a custom template



TEMPLATE



1 resource

Edit



BASICS

* Subscription

Visual Studio Enterprise

* Resource group ⓘ

Create new Use existing

* Location

North Europe



SETTINGS

Storage Accounts_acdppbookstor_name



TERMS AND CONDITIONS

Pin to dashboard

Purchase





Edit template

Edit your Azure Resource Manager template



+ Add resource



↑ Quickstart tem...



↓ Download



▶ Parameters (1)

▫ Variables (0)

▼ Resources (1)

[parameters('storageAccounts_acd...



```
1 {
2   "$schema": "https://schema.management.azure.com/schemas/2019-04-01/deploymentTemplate.json#",
3   "contentVersion": "1.0.0.0",
4   "parameters": {
5     "storageAccounts_acdppbookstor_name": {
6       "defaultValue": "acdppbookstor",
7       "type": "String"
8     }
9   },
10  "variables": {},
11  "resources": [
12    {
13      "comments": "Generalized from https://github.com/Azure/azure-quickstart-templates/blob/master/153-storage-accounts/153-storageAccounts_acdppbookstor.json",
14      "type": "Microsoft.Storage/storageAccounts",
15      "sku": {
16        "name": "Standard_RAGRS",
17        "tier": "Standard"
18      },
19      "kind": "Storage",
20      "name": "[parameters('storageAccounts_acdppbookstor_name')]"
```

Save

Discard





Edit template

Edit your Azure Resource Manager template

+ Add resource

↑ Quickstart tem...

↓ Download

- ▶ Parameters (1)
- Variables (0)
- ▼ Resources (1)
 - [parameters('storageAccounts_acd...

```
1 {
2   "$schema": "https://schema.management
3   "contentVersion": "1.0.0.0",
4   "parameters": {
5     "storageAccounts_acdppbookstor_n
6     "defaultValue": "acdppbookstor
7     "type": "String"
8   }
9 },
10 "variables": {},
11 "resources": [
12   {
13     "comments": "Generalized from
14     '/subscriptions/02f13438-c22f-4f1b-ad33-
15     Storage/storageAccounts/acdppbookstor'."
16     "type": "Microsoft.Storage/s
17     "sku": {
18       "name": "Standard_RAGRS"
19       "tier": "Standard"
20     },
21     "kind": "Storage",
22     "name": "[parameters('storag
```

Save

Discard





Edit template

Edit your Azure Resource Manager template



+ Add resource

↑ Quickstart tem...

↓ Download

Add a resource to the template

* Select a resource

- App Service plan (server farm)
- Availability set
- MySQL database
- SQL database
- SQL server
- Storage account
- Ubuntu virtual machine
- Virtual network
- Web app
- Windows virtual machine

```
14         "type": "Microsoft.Storage/s  
15         "sku": {  
16             "name": "Standard_RAGRS"  
17             "tier": "Standard"  
18         },  
19         "kind": "Storage",  
20         "name": "[parameters('storag
```

Save

Discard





Edit template

Edit your Azure Resource Manager template

+ Add resource

↑ Quickstart tem...

↓ Download

- Parameters (1)
- Variables (0)
- Resources (1)
 - [parameters('storageAccounts_acd...

```
1 {
2   "$schema": "https://schema.management
3   "contentVersion": "1.0.0.0",
4   "parameters": {
5     "storageAccounts_acdppbookstor_n
6     "defaultValue": "acdppbookstor
7     "type": "String"
8   }
9 },
10 "variables": {},
11 "resources": [
12   {
13     "comments": "Generalized from
14     '/subscriptions/02f13438-c22f-4f1b-ad33-
15     Storage/storageAccounts/acdppbookstor'."
16     "type": "Microsoft.Storage/s
17     "sku": {
18       "name": "Standard_RAGRS"
19       "tier": "Standard"
20     },
21     "kind": "Storage",
22     "name": "[parameters('storag
```

Save Discard





Edit template

Edit your Azure Resource Manager template

+ Add resource

↑ Quickstart tem...

↓ Download



Load a quickstart template

Select a template (disclaimer) ⓘ

- 100-blank-template
- 101-acs-dcos
- 101-acs-kubernetes
- 101-acs-swarm
- 101-app-service-certificate-standard
- 101-app-service-certificate-wildcard
- 101-application-gateway-create

```
15         "sku": {  
16             "name": "Standard_RAGRS",  
17             "tier": "Standard"  
18         },  
19         "kind": "Storage",  
20         "name": "[parameters('storage'...
```

Save

Discard





Edit template

Edit your Azure Resource Manager template

+ Add resource

↑ Quickstart tem...

↓ Download



- Parameters (1)
- Variables (0)
- Resources (1)
 - [parameters('storageAccounts_acd...

```
1 {
2   "$schema": "https://schema.management
3   "contentVersion": "1.0.0.0",
4   "parameters": {
5     "storageAccounts_acdppbookstor_n
6     "defaultValue": "acdppbookstor
7     "type": "String"
8   }
9 },
10 "variables": {},
11 "resources": [
12   {
13     "comments": "Generalized from
14     '/subscriptions/02f13438-c22f-4f1b-ad33-
15     Storage/storageAccounts/acdppbookstor'."
16     "type": "Microsoft.Storage/s
17     "sku": {
18       "name": "Standard_RAGRS"
19       "tier": "Standard"
20     },
21     "kind": "Storage",
22     "name": "[parameters('storag
```

Save

Discard



Custom deployment

Deploy from a custom template



TEMPLATE



1 resource



Edit

BASICS

* Subscription

Visual Studio Enterprise

* Resource group

Create new Use existing

* Location

North Europe

SETTINGS

Storage Accounts_acdppbookstor_name

TERMS AND CONDITIONS

Pin to dashboard

Purchase





Custom deployment

Deploy from a custom template



TEMPLATE



1 resource



Edit

BASICS

* Subscription

Visual Studio Enterprise

* Resource group ⓘ

Create new Use existing

* Location

North Europe

SETTINGS

Storage Accounts_acdppbookstor_name

TERMS AND CONDITIONS

Pin to dashboard

Purchase



Custom deployment

Deploy from a custom template



* Location

North Europe



SETTINGS



Storage Accounts_acdppbookstor_name



TERMS AND CONDITIONS

[Azure Marketplace Terms](#) | [Azure Marketplace](#)

By clicking "Purchase," I (a) agree to the applicable legal terms associated with the offering; (b) authorize Microsoft to bill my current payment method for the fees associated with the offering(s), including applicable taxes, with the same frequency as my Azure subscription, until I discontinue use of the offering(s); and (c) agree that, if the deployment involves third-party offerings, Microsoft may share my contact information and other details of such deployment with the publisher of the offering.

I agree to the terms and conditions stated above



Pin to dashboard



Purchase



Open Existing Template

Load ARM Quickstart Template

Edit Parameter Definitions

Download ARM Template

Create Visualizer Button

Deploy To Azure

Portal UI Editor

Toolbox



Virtual Machine



VM Extension



Availability Set



Load Balancer



Network



NIC



Public IP



NSG



App Gateway



Storage Acct



Automation



Workflow



Deployment



Server Farm



Hosting Env



Key Vault

domainOwnershipIdentifiers



rootHostname/certificateOrder

cer

cer

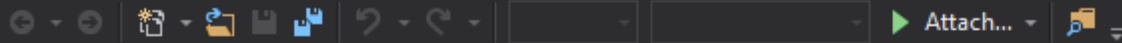

Visual Studio

Start

New Project...

Open Project...

Open from Source Control...

Recent

ACDARMTemplateDemo

ARMTemplates

WindowsFormsApplication1

Discover what's new in Enterprise 2015

[Learn about new features in Enterprise 2015](#)

[See what's new in the .NET Framework](#)

[Explore what's new in Visual Studio Team Services](#)

Ready to Cloud-power your experience?

[Connect to Azure](#)

News

News from Connect(); 2016

At the Connect(); event in New York, we are announcing a whole bunch of cool new stuff. The news at Connect(); is broad so I'm going to focus on t...

NEW Dienstag, November 22, 2016

Announcing the Fastest ASP.NET Yet, ASP.NET Core 1.1 RTM

We are happy to announce that ASP.NET Core 1.1 is now available as a stable release on nuget.org! This release includes a bunch of great new features along...

NEW Dienstag, November 22, 2016

Announcing UWP Community Toolkit 1.2

Following our commitment to ship new versions at a fast pace, I'm thrilled to announce the availability of UWP Community Toolkit 1.2. If you want to get a first...

Ready



Frag mich etwas



New Project

Recent

.NET Framework 4.5.2

Sort by: Default

Installed

Templates

Visual C#

Windows

Web

Android

Apple Watch

Cloud

QuickStarts

Cross-Platform

Extensibility

Extensions

iPad

iPhone

LightSwitch

Office SharePoint

Office/SharePoint

Reporting



Azure Cloud Service

Visual C#



Get Microsoft Azure SDK for .NET

Visual C#



ASP.NET Web Application

Visual C#



Azure WebJob

Visual C#



Azure Mobile App

Visual C#



Azure Mobile Service

Visual C#



Azure Resource Group

Visual C#

Online

[Click here to go online and find templates.](#)

Name:

ACDARMTemplateDemo









Location:

c:\users\oliver michalski\documents\visual studio 2015\Projects

Solution name:

ACDARMTemplateDemo

Select Azure Template

-  DocumentDB
MICROSOFT
-  Windows Virtual Machine Scale Set
MICROSOFT
-  Linux Virtual Machine Scale Set
MICROSOFT
-  Service Fabric Cluster
MICROSOFT
-  Web app
MICROSOFT
-  Web app + SQL
MICROSOFT
-  Windows Virtual Machine
MICROSOFT
-  Windows Server Virtual Machines
with Load Balancer
MICROSOFT



DocumentDB

By Microsoft

Allows you to create a new Azure DocumentDB Account.

VERSION: 2015-04-08

This template allows you to create a new Azure DocumentDB Account. This template allows you to specify a default consistency policy if you wish, if you do not specify one the default consistency policy will be applied.

OK

Select Azure Template

 Windows Server Virtual Machines
with Load Balancer
MICROSOFT

 Logic App
MICROSOFT

 Logic App and API App
MICROSOFT

 Docker on Ubuntu Server
CANONICAL + MS OPEN TECH

 Ubuntu Server
MICROSOFT

 Web app + CDN
MICROSOFT

 Storage + CDN
MICROSOFT

 Blank Template
MICROSOFT



Blank Template

By Microsoft

The blank template will add a deployment project template file and other files needed for deploying Resource Manager.

VERSION: 1.0

OK

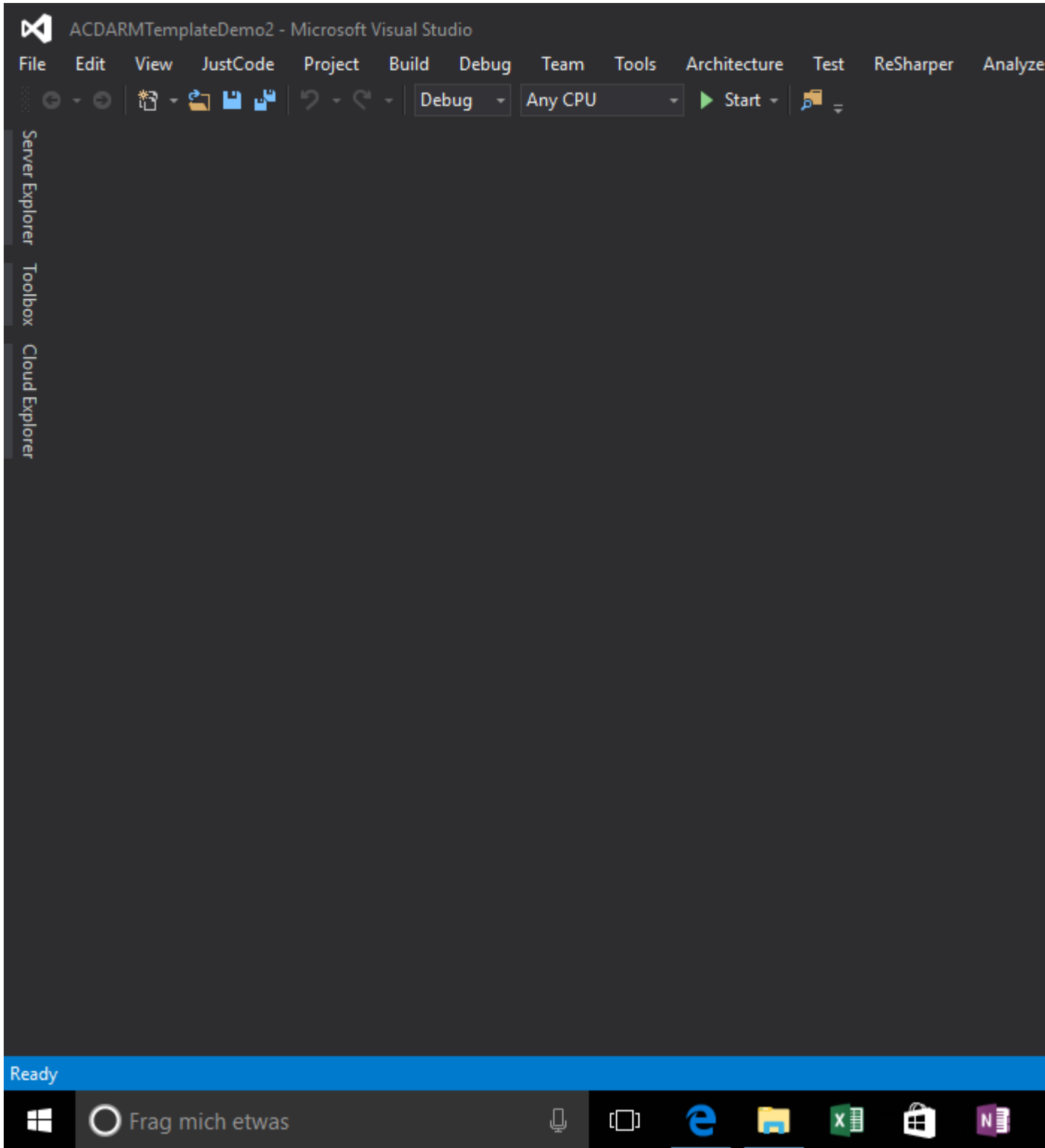



New

Recent

App Services

Virtual machines (classic)

Virtual machines

SQL databases

Cloud services (classic)

Security Center

Subscriptions

Azure Active Directory

Monitor

Billing

Help + support

More services >

Filter

By category

Crypteron

Import/export jobs

Mailjet Email Service

Marketplace

Recent

Resource Explorer

Service health

SQL elastic job accounts

Tags

Templates

What's new

PREVIEW

[Help improve the service menu!](#)



Resource Explorer

Windows Server User Group Berlin



- ▶ Providers
- ▶ Subscriptions

Choose a node

1



Resource Explorer

Windows Server User Group Berlin



Search...

- Providers
- Subscriptions
 - Visual Studio Enterprise
 - Providers
 - ResourceGroups
 - acdappserv
 - acdbooktest
 - acdcsiotdemo
 - acddev
 - acdiotdemo
 - acdiotdev
 - acdml
 - acdppbook
 - Resources
 - [Microsoft.ClassicCompute/dom...
 - [Microsoft.Storage/storageAcco...
 - Deployments
 - acdtestlabRG182808
 - Default-ServiceBus-NorthEurope

[Microsoft.Storage/storageAccounts

Open blade

/subscriptions/02f13438-c22f-4f1b-ad3

```
1 {
2   "id": "/subscriptions/02f13438-c22f-4f1b-ad3-00000000-0000-0000-0000-000000000000/resourceGroups/acdppbook/providers/Microsoft.Storage/storageAccounts/acdppbookstor",
3   "kind": "Storage",
4   "location": "northeurope",
5   "name": "acdppbookstor",
6   "properties": {
7     "creationTime": "2016-07-27T12:00:00.0000000Z",
8     "primaryEndpoints": {
9       "blob": "https://acdppbookstor.blob.core.windows.net/",
10      "file": "https://acdppbookstor.file.core.windows.net/",
11      "queue": "https://acdppbookstor.queue.core.windows.net/",
12      "table": "https://acdppbookstor.table.core.windows.net/"
13    },
14    "primaryLocation": "northeurope",
15    "provisioningState": "Succeeded",
16    "secondaryEndpoints": {
17      "blob": "https://acdppbookstor-secondary.blob.core.windows.net/",
18      "queue": "https://acdppbookstor-secondary.queue.core.windows.net/",
19      "table": "https://acdppbookstor-secondary.table.core.windows.net/"
20    }
21  }
22 }
```

Chapter 3: Deploying and Synchronizing Azure Active Directory

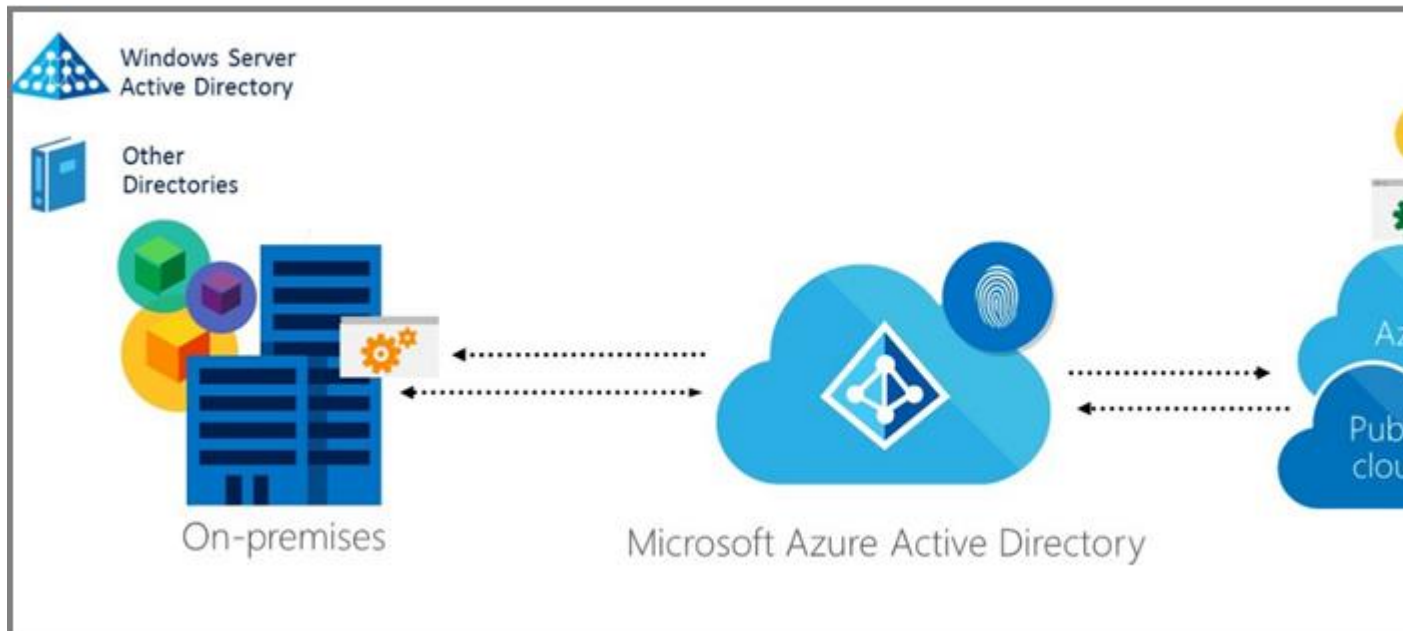

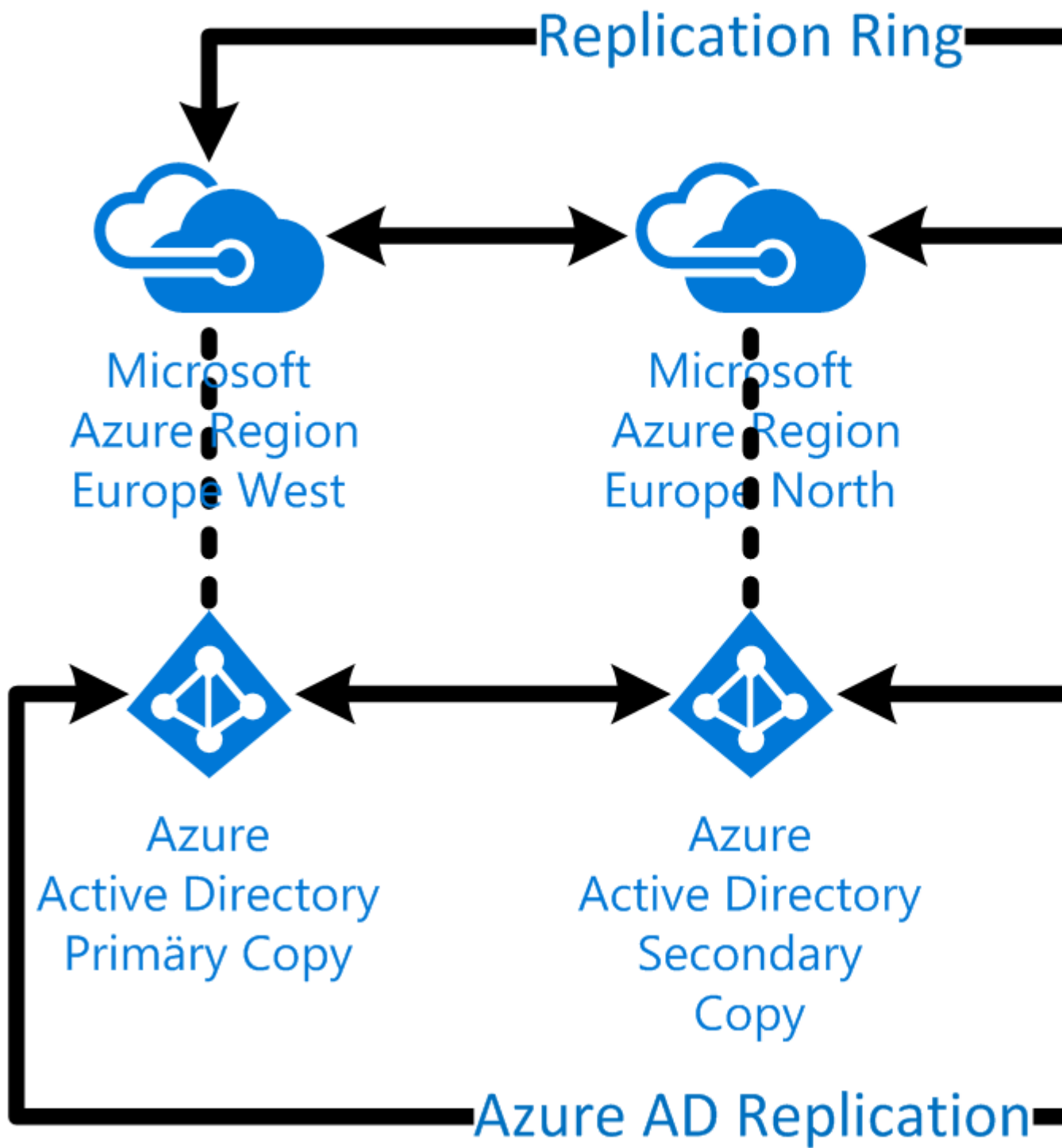

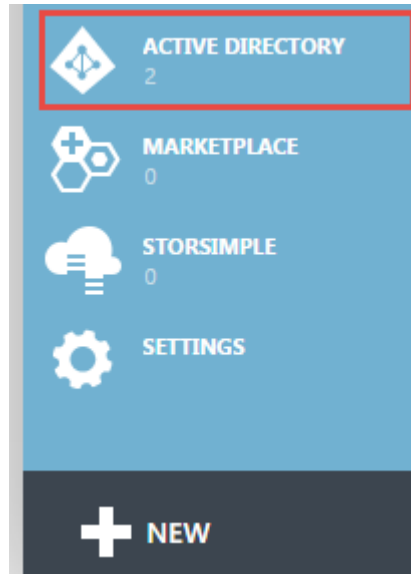

active directory

DIRECTORY ACCESS CONTROL NAMESPACES MULTI-FACTOR AUTH PROVIDERS RIGHTS MAN...

| NAME | STATUS | ROLE | SUBSCRIPTION |
|-----------------------|----------|----------------------|------------------------|
| Standardverzeichnis → | ✓ Active | Global Administrator | Shared by all Stand... |

active directory

DIRECTORY ACCESS CONTROL NAMESPACES MULTI-FACTOR AUTH PROVIDERS RIGHTS MANAGEMENT

| NAME | ↑ | STATUS | ROLE | SUBSCRIPTION | DATACENTER REGION | COUNTRY OR RE... | 🔍 |
|-------------------|---|----------|----------------------|---------------------------------------|-----------------------|------------------|---|
| [REDACTED] | → | ✓ Active | Global Administrator | Shared by all DataCenter-Flo sub... | Europe, United States | Germany | |
| Default Directory | → | ✓ Active | Global Administrator | Shared by all Default Directory su... | Europe, United States | Germany | |

NEW



BIZTALK SERVICE



CDN



AUTOMATION



SCHEDULER



API MANAGEMENT



OPERATIONAL INSIGHTS
NOT AVAILABLE



REMOTEAPP



ACTIVE DIRECTORY

DIRECTORY

ACCESS CONTROL

MULTI-FACTOR AUTH PROVIDER



CUSTOM CREATE

Add directory

DIRECTORY ?

Create new directory

NAME ?

Packt Publishing Demo

DOMAIN NAME ?

packpubdemo



.onmicrosoft.com

COUNTRY OR REGION ?

Germany

This is a B2C directory. ? **PREVIEW**



active directory

DIRECTORY ACCESS CONTROL NAMESPACES MULTI-FACTOR AUTH PROVIDERS RIGHTS MANAGEMENT

| NAME | STATUS | ROLE | SUBSCRIPTION | DATACENTER REGION | COUNTRY OR RE... |
|-----------------------|--------|----------------------|---------------------------------------|-----------------------|------------------|
| [REDACTED] | Active | Global Administrator | Shared by all DataCenter-Flo sub... | Europe, United States | Germany |
| Default Directory | Active | Global Administrator | Shared by all Default Directory su... | Europe, United States | Germany |
| Packt Publishing Demo | Active | Global Administrator | Shared by all Packt Publishing De... | Europe, United States | Germany |

A vertical navigation sidebar with a blue background. It contains the following items from top to bottom:

- ACTIVE DIRECTORY** with a diamond icon and the number 3.
- MARKETPLACE** with a hexagon icon and the number 0.
- STORSIMPLE** with a cloud icon and the number 0.
- SETTINGS** with a gear icon.
- A dark blue button at the bottom with a white plus sign and the text **NEW**.

- CDN 0
- AUTOMATION 0
- SCHEDULER 0
- API MANAGEMENT 0
- MACHINE LEARNING 0
- STREAM ANALYTICS 0
- OPERATIONAL INSIGHTS 0
- NETWORKS 0
- TRAFFIC MANAGER 0
- REMOTEAPP 0
- MANAGEMENT SERVICES 0
- ACTIVE DIRECTORY 3
- MARKETPLACE 0
- STORSIMPLE 0
- SETTINGS

SUBSCRIPTIONS MANAGEMENT CERTIFICATES ADMINISTRATORS AFFINITY GROUPS USAGE REMOTEAPP

| SUBSCRIPTION | SUBSCRIPTION ID | ACCOUNT ADMINISTRATOR | DIRECTORY |
|---------------------------------|-----------------|-----------------------|--------------|
| Visual Studio Enterprise | [REDACTED] | [REDACTED] | DataCenter-F |
| Visual Studio Premium with MSDN | [REDACTED] | [REDACTED] | DataCenter-F |

+ NEW

 EDIT DIRECTORY

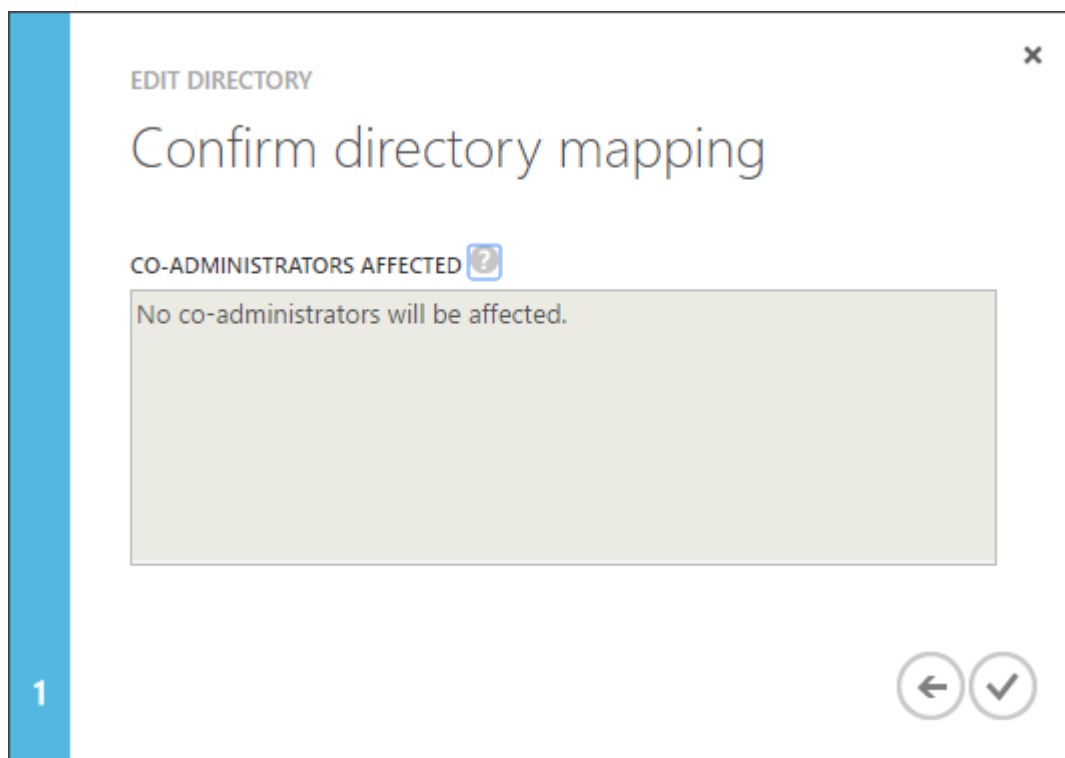
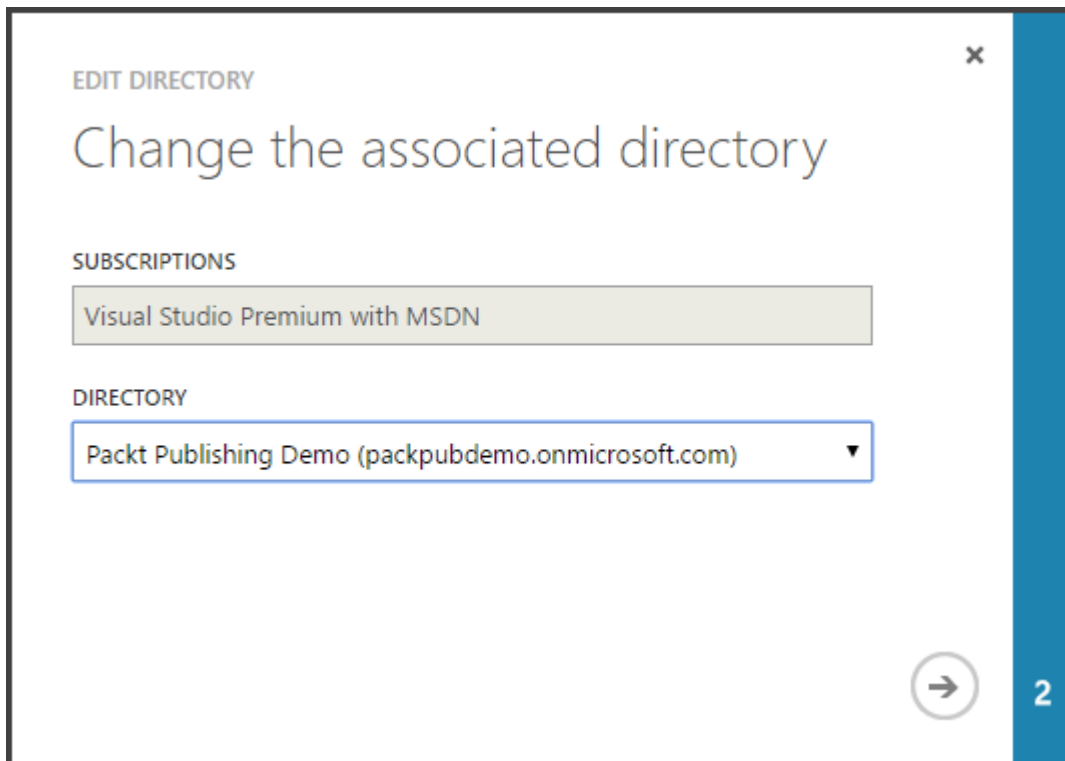

settings

SUBSCRIPTIONS MANAGEMENT CERTIFICATES ADMINISTRATORS AFFINITY GROUPS USAGE REMOTEAPP

| SUBSCRIPTION | SUBSCRIPTION ID | ACCOUNT ADMINISTRATOR |
|--------------|-----------------|-----------------------|
|--------------|-----------------|-----------------------|

settings

SUBSCRIPTIONS MANAGEMENT CERTIFICATES ADMINISTRATORS AFFINITY GROUPS USAGE REMOTEAPP

| NAME | SUBSCRIPTION | SUBSCRIPTION ID |
|------------|---------------------------------|--------------------------------------|
| [REDACTED] | Visual Studio Enterprise | 43b8966b-fc55-463a-835c-c3f6181b9382 |
| | Visual Studio Enterprise | 43b8966b-fc55-463a-835c-c3f6181b9382 |
| | Visual Studio Premium with MSDN | 4a8ad611-6c01-4f99-ba5e-2cad700afc54 |

ADD EDIT REMOVE

Office 365 Admin center preview

Home > Active users

+ Add a user More ▾ Fil

 Display name ^

-  RECOVERY SERVICES
0
-  CDN
0
-  AUTOMATION
0
-  SCHEDULER
0
-  API MANAGEMENT
0
-  MACHINE LEARNING
0
-  STREAM ANALYTICS
0
-  OPERATIONAL INSIGHTS
0
-  NETWORKS
0
-  TRAFFIC MANAGER
0
-  REMOTEAPP
0
-  MANAGEMENT SERVICES
-  ACTIVE DIRECTORY
3

active directory



DIRECTORY ACCESS CONTROL NAMESPACES

| NAME | STATUS |
|-------------------------|----------|
| [REDACTED] | ✓ Active |
| Default Directory | ✓ Active |
| Packt Publishing D... → | ✓ Active |

packt publishing demo

USERS GROUPS APPLICATIONS DOMAINS DIRECTORY INTEGRATION CONFIGURE REPORTS LICENSES

| DISPLAY NAME | USER NAME | SOURCED FROM |
|--------------|------------|-------------------|
| [REDACTED] | [REDACTED] | Microsoft account |

 NEW
  ADD USER
  MANAGE MULTI-FACTOR AUTH

<https://portal.azure.com/>



New

Resource groups

All resources

Recent

App Services

Virtual machines (classic)

Virtual machines

SQL databases

Cloud services (classic)

Security Center

Subscriptions

Azure Active Directory

Monitor

Billing

Help + support

More services >

azure |

2

Azure Active Directory

PREVIEW



Azure AD B2C



Azure AD Cloud App Discovery



Azure AD Connect Health



Azure AD Identity Protection



Azure AD Privileged Identity Management



Azure Information Protection

PREVIEW



MyCloudIT - Azure Desktop Hosting



1

Search (Ctrl+/)

- Overview
- Quick start
- MANAGE
 - Users and groups
 - Enterprise applications
 - App registrations
 - Azure AD Connect
 - Domain names
 - Password reset
 - Company branding
 - User settings
 - Properties
- ACTIVITY
 - Sign-ins
 - Audit logs

The Azure AD management experience is in preview. Learn more

Users and groups



Enterprise applications

Azure AD application access management

Recommended

Sync with Windows Server AD
Sync users and groups from your on-premises directory to your Azure AD

Self-service password reset
Enable your users to reset their forgotten passwords

Company branding
Customize the text and graphics your users see when they sign in to your Azure AD

The Azure AD management experience is in preview. [Learn more](#) →

Search (Ctrl+/)

- Overview
- Quick start

MANAGE

- Users and groups
- Enterprise applications
- App registrations
- Azure AD Connect
- Domain names
- Password reset
- Company branding
- User settings
- Properties

ACTIVITY

- Sign-ins
- Audit logs

Users and groups



Quick tasks

- Add a user
- Add a group
- Find a user
- Find a group
- Find an enterprise app

Enterprise applications

Azure AD application access management

Azure AD Connect

Sync not enabled

App registrations

2

Recommended

Sync with Windows Server AD
Sync users and groups from your on-premises directory to your Azure AD

Self-service password reset
Enable your users to reset their forgotten passwords

Company branding
Customize the text and graphics your users see when they sign in to your Azure AD

Other capabilities

- Identity Protection
- Privileged Identity Management
- Cloud App Discovery

What's new

- General Availability of Azure AD Premium P2
- Microsoft partners with Ping Identity on Secure Remote Access

- ☰
- +
- 📦
- 📊
- 🕒
- 🌐
- 🖥️
- 🖥️
- SQL
- ⚙️
- 🛡️
- 🔑
- 📡
- 📊
- 🕒
- 🖥️
- 🐙
- >

Shift+Space to toggle favorites

 Users and groups PREVIEW 



Users and groups

DataCenter-Flo - Azure Active Directory - PREVIEW



Overview

MANAGE

All users

All groups

Password reset

Company branding

User settings

Group settings

Device Settings

ACTIVITY

Sign-ins

Audit logs

Essentials ^

Directory
DataCenter-Flo

Access

Users Sign Ins

SIGN-INS FOR 'ALL USERS' BETWEEN 1/19/2017 AND 2/18/2017.

Start a free trial to use this feature

1 AM

ALL USERS

Users

6

AC



FK



Microsoft Azure Users and groups - All users

Users and groups - All users
DataCenter-Flo - Azure Active Directory - PREVIEW

Search (Ctrl+/)

Overview

MANAGE

- All users
- All groups
- Password reset
- Company branding
- User settings
- Group settings
- Device Settings

ACTIVITY

- Sign-ins
- Audit logs

+ Add Columns Multi-Factor Authentication

Search users

| NAME | USER NAME |
|---------------------------|-----------|
| AC AD Connect Synch Admin | |
| | |
| | |
| | |
| | |
| | |
| | |

Microsoft Azure Users and groups - All users

Users and groups - All users
DataCenter-Flo - Azure Active Directory - PREVIEW

Search (Ctrl+/)

+ Add Columns Multi-Factor Authentication

User

DataCenter-Flo - PREVIEW

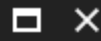

* Name ⓘ

Peter Pan



* User name ⓘ

peter@pan.cloud



peter@pan.cloud will be added as...
guest

Include a personal message with the invitation

Profile ⓘ

Not configured



Properties ⓘ

Default



Groups ⓘ

0 groups selected



Profile

User - PREVIEW

General

First name

Last name

Work info

Job title

Department

Properties

User - PREVIEW

Source of Authority

Groups

select groups to join

+ Invite

Select ⓘ



Users and groups - All users

DataCenter-Flo - Azure Active Directory - PREVIEW

Overview

MANAGE

All users

All groups

Password reset

Company branding

User settings

Group settings

Device Settings

ACTIVITY

Sign-ins

Audit logs

Add Columns Multi-Factor Authentication

NAME

USER NAME

AD Connect Synch Admin





FK



AD Connect Synchronisation Admin - Directory role

User - PREVIEW

 Search (Ctrl+*/*)

 Overview

MANAGE

 Profile

 Directory role

 Groups

 Devices

 Azure resources

ACTIVITY

 Sign-ins

 Audit logs

 Save  Discard

Directory role

- User
- Global administrator
- Limited administrator

Global administrators have full control over all directory resources.

[Learn More](#)

 Save  Discard

Directory role 

- User
- Global administrator
- Limited administrator

Select the administrative role or roles for this user.
[Learn More](#)

Password administrator 

Service administrator 

Billing administrator 

Exchange administrator 

Skype for Business administrator 

User administrator 

SharePoint administrator 

Compliance administrator 

Security reader 

Security administrator 

Privileged role administrator 

Intune Service administrator 

Guest inviter 

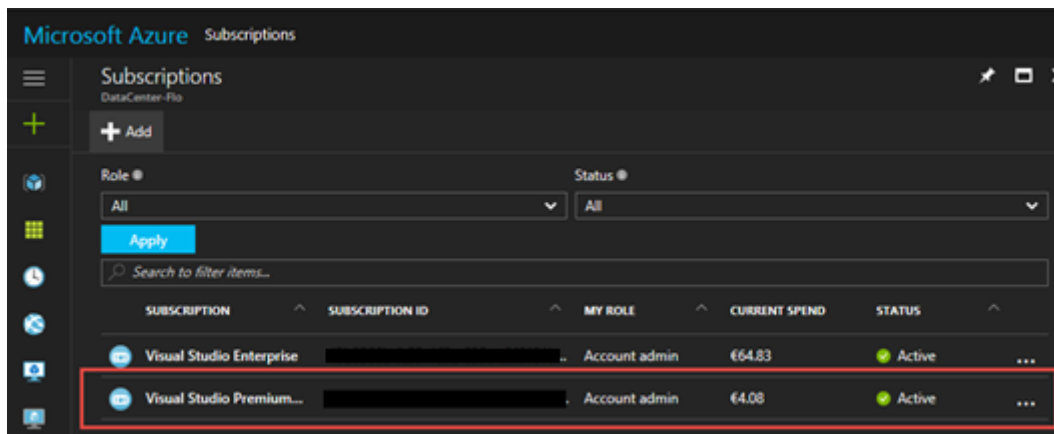
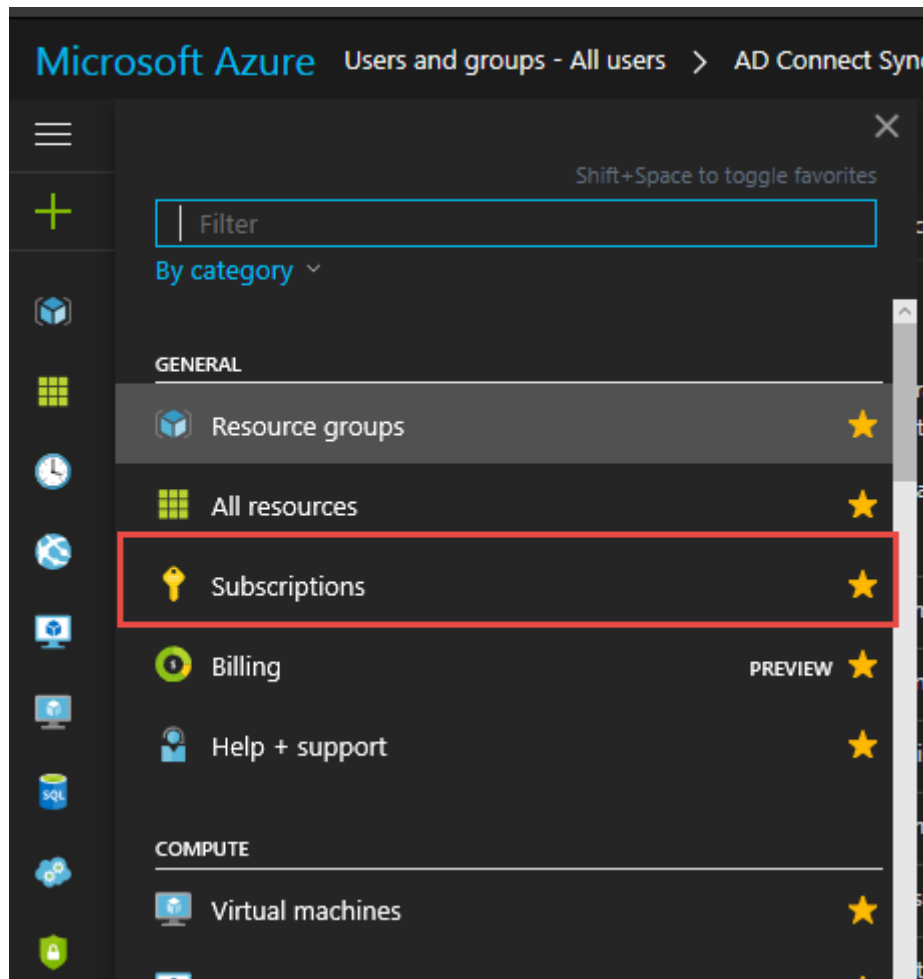

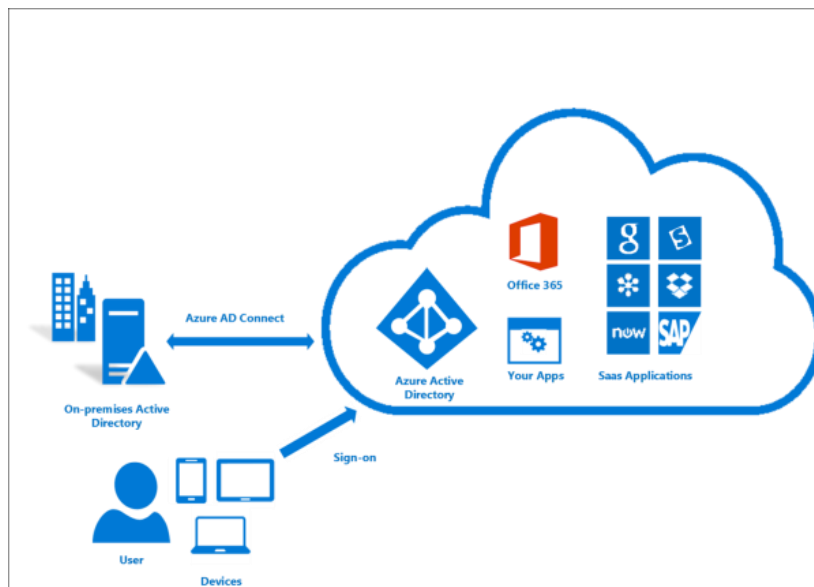
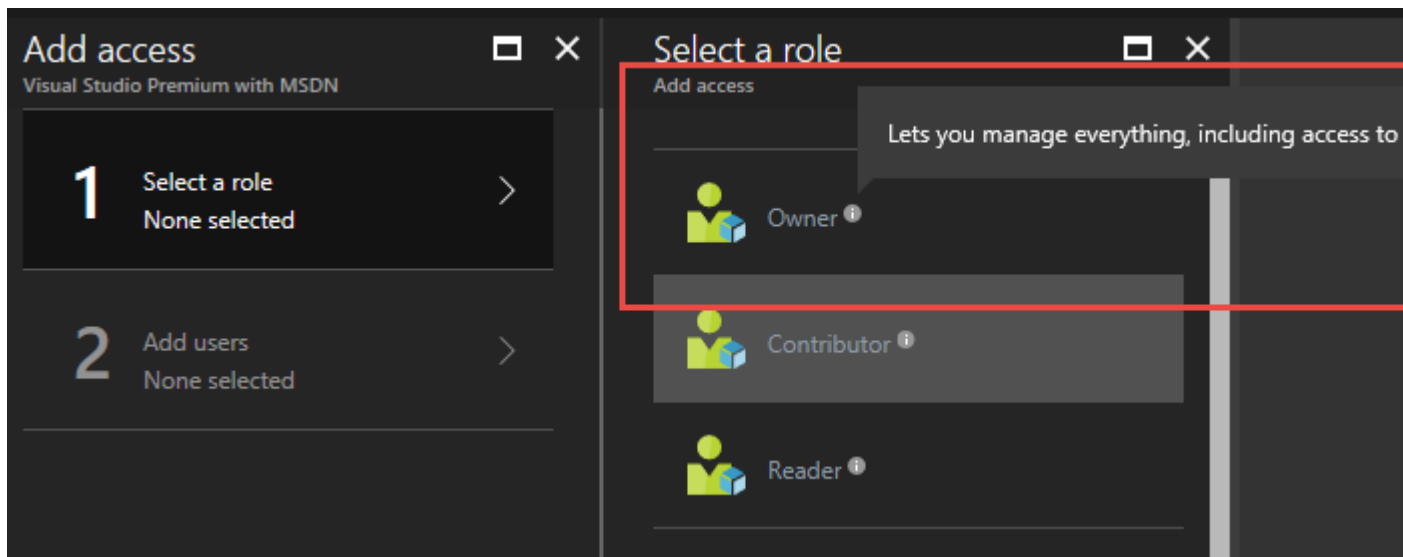
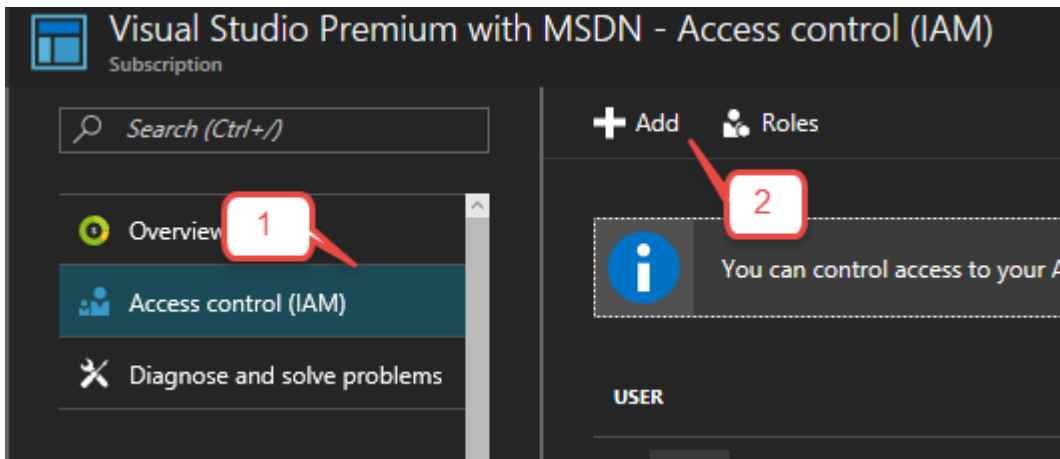



View and manage your synchronization rules

| | | | |
|--------------------------------------|----------------------|----------------------|------------------------|
| Direction: | MV Object Type: | Connector: | Connector Object Type: |
| <input type="text" value="Inbound"/> | <input type="text"/> | <input type="text"/> | <input type="text"/> |
| Password Sync: | MV attribute: | Connector Attribute: | |
| <input type="text" value="*"/> | <input type="text"/> | <input type="text"/> | |

| Name | Connector | Precedence | Connector Object Type | M |
|------|-----------|------------|-----------------------|---|
|------|-----------|------------|-----------------------|---|

Type:
Transformations:
Disabled:

Scoping filters
Join rules

Synchronization Service Manager on [redacted]

File Tools Actions Help

Operations Connectors Metaverse Designer Metaverse Search

Connector Operations

| Name | Profile Name | Status | Start Time | End Time |
|--------------|-----------------------|---------|----------------------|----------------------|
| local | Export | success | 7/24/2016 7:27:02 PM | 7/24/2016 7:27:02 PM |
| onmicroso... | Export | success | 7/24/2016 7:26:33 PM | 7/24/2016 7:27:01 PM |
| onmicroso... | Delta Synchronization | success | 7/24/2016 7:26:30 PM | 7/24/2016 7:26:30 PM |
| local | Delta Synchronization | success | 7/24/2016 7:26:28 PM | 7/24/2016 7:26:30 PM |
| onmicroso... | Delta Import | success | 7/24/2016 7:26:07 PM | 7/24/2016 7:26:28 PM |
| local | Delta Import | success | 7/24/2016 7:26:07 PM | 7/24/2016 7:26:07 PM |
| local | Export | success | 7/24/2016 6:56:43 PM | 7/24/2016 6:56:43 PM |
| onmicroso... | Export | success | 7/24/2016 6:56:14 PM | 7/24/2016 6:56:42 PM |
| onmicroso... | Delta Synchronization | success | 7/24/2016 6:56:11 PM | 7/24/2016 6:56:12 PM |
| local | Delta Synchronization | success | 7/24/2016 6:56:07 PM | 7/24/2016 6:56:10 PM |
| onmicroso... | Delta Import | success | 7/24/2016 6:55:45 PM | 7/24/2016 6:56:05 PM |
| local | Delta Import | success | 7/24/2016 6:55:44 PM | 7/24/2016 6:55:44 PM |
| local | Export | success | 7/24/2016 6:26:10 PM | 7/24/2016 6:26:10 PM |
| onmicroso... | Export | success | 7/24/2016 6:25:47 PM | 7/24/2016 6:26:09 PM |
| onmicroso... | Delta Synchronization | success | 7/24/2016 6:25:45 PM | 7/24/2016 6:25:45 PM |
| local | Delta Synchronization | success | 7/24/2016 6:25:43 PM | 7/24/2016 6:25:44 PM |
| onmicroso... | Delta Import | success | 7/24/2016 6:25:20 PM | 7/24/2016 6:25:42 PM |
| local | Delta Import | success | 7/24/2016 6:25:19 PM | 7/24/2016 6:25:19 PM |

Profile Name: User

Step Type: Partition: Status:

Start Time: End Time:

| | |
|----------------------------|------------------------|
| Synchronization Statistics | Connection Status |
| | |
| | Synchronization Errors |
| | |

Loading run step details...

Azure ADSync Key Management Utility

Welcome to the Azure ADSync Encryption Key Management Wizard.

This wizard allows you to manage the keys used to encrypt data and credentials stored in Azure ADSync.

Export key set
 Add new key to key set (requires service to be stopped)
 Re-encrypt all Azure ADSync data with new key
 Abandon key set (requires service to be stopped)

Description

This option allows you to export and backup the keys used to encrypt data in Azure ADSync to a file. This file should be stored in a secure location.

< Back Next > Cancel

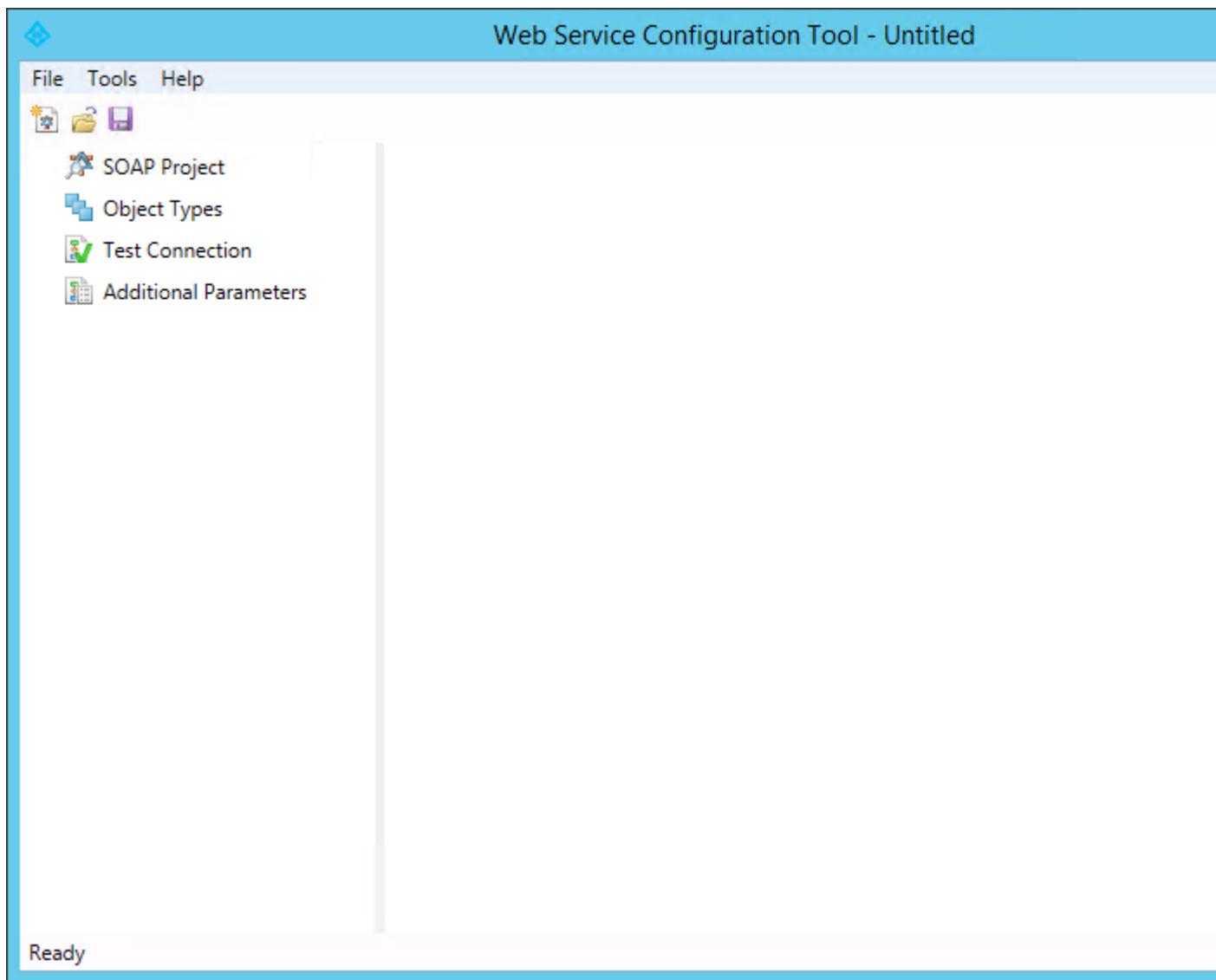

User sign-in

Select the Sign On method.

- Password Synchronization [?](#)
- Pass-through authentication [?](#) (Preview)
- Federation with AD FS [?](#)
- Do not configure [?](#)

Select this option to enable single sign on for your corporate desktop users:

- Enable single sign on [?](#) (Preview)

PASSWORD SYNCHRONIZATION

This option allows your users to sign in to the cloud using the same passwords that they use on-premises.

Password synchronization does not store or send clear text passwords.

[Learn more](#)

PASS-THROUGH AUTHENTICATION

Pass-through authentication enables Azure Active Directory to authenticate users using your on-premises identity infrastructure.

[Learn more](#)

SINGLE SIGN ON

This option allows your users to do federated sign in using AD FS.

While logged in to the corporate network, your users can access cloud resources without entering their passwords again.

[Learn more](#)

DO NOT CONFIGURE

This option allows your users to do federated sign in using a solution not managed by this wizard.

While logged in to the corporate network, your users can access cloud resources without entering their passwords again.

[Learn more](#)

Single sign on

This option enables users on the corporate network to get a single sign on experience when accessing cloud services from their domain joined desktop machines.

[Learn more](#)

User

DataCenter-Flo - PREVIEW

* Name ⓘ
ADConnect Synch ✓

* User name ⓘ
azureadsynch@ [REDACTED] ✓

 azureadsynch [REDACTED] will be added as a guest

Include a personal message with the invitation

Profile ⓘ
Not configured >

Properties ⓘ
Default >

Groups ⓘ
0 groups selected >

AD Connect Synch Admin - Directory role



User - PREVIEW

 Overview

MANAGE

 Profile

 **Directory role**

 Save  Discard

Directory role ⓘ

- User
- Global administrator
- Limited administrator

Global administrators have full control over all directory resources.
[Learn More](#)

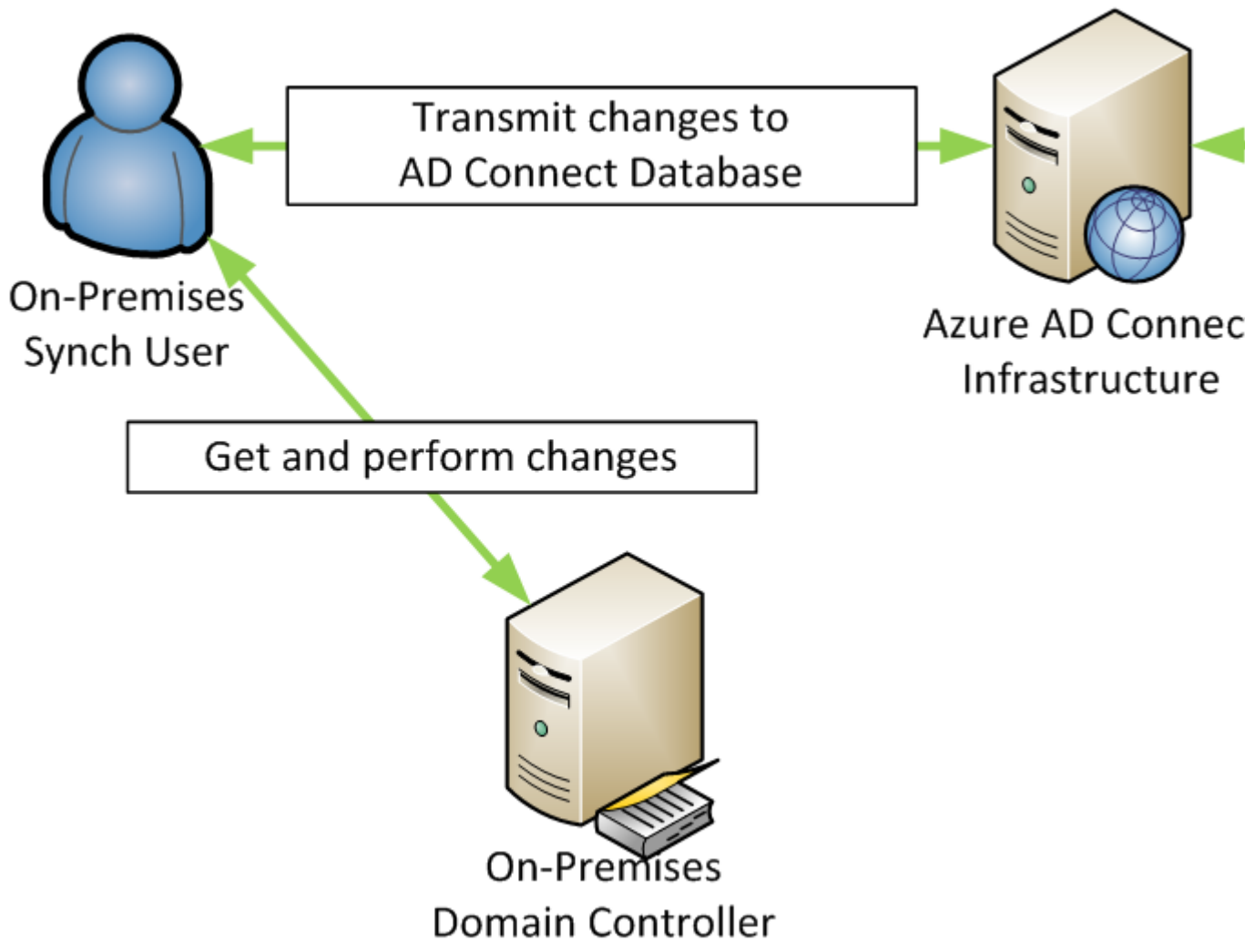



ADFS Proxy

Transmits Access Tickets
Grants or Denies Access To



ADFS Server

Grants or denies access b
on Kerberos

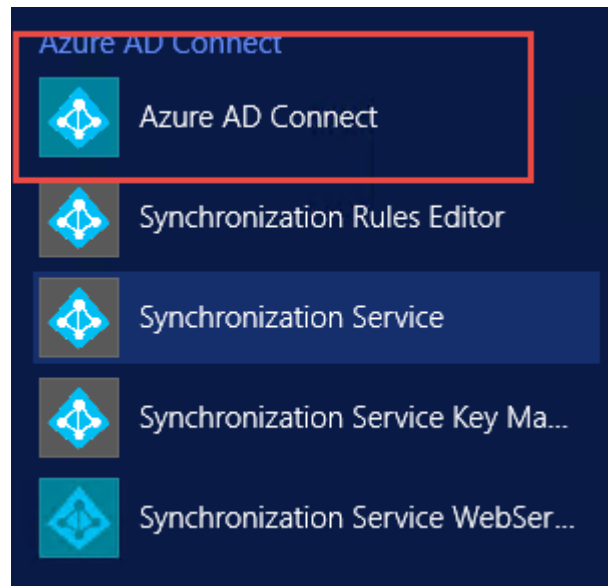

Welcome to Azure AD Connect

Run this installation tool on the server where the synchronization service component is installed.

Azure Active Directory Connect integrates your on-premises and online directories.

This installation tool will:

- Guide you in selecting a solution (for example, password synchronization or federated authentication)
- Install identity synchronization and other Microsoft software components required for the selected solution
- Verify the integration of your on-premises and online directories

[Learn more](#)

I agree to the [license terms](#) and [privacy notice](#).

Welcome

Express Settings

Express Settings

If you have a **single** Windows Server Active Directory forest, we will do the following:

- Configure synchronization of identities in the current AD forest of DCF
- Configure password synchronization from on-premises AD to Azure AD
- Start an initial synchronization
- Synchronize all attributes
- Enable Auto Upgrade

[Learn more about express settings](#)

If you would like different settings, click Customize.

Datacenter-Flo.local is not a routable domain. It is recommended to use custom user sign-in options.

[Learn more about non-routable domains and user sign-in settings.](#)

Customize

User sign-in

Select the Sign On method.

- Password Synchronization [?](#)
- Pass-through authentication [?](#) (Preview)
- Federation with AD FS [?](#)
- Do not configure [?](#)

Select this option to enable single sign on for your corporate desktop users:

- Enable single sign on [?](#) (Preview)

Welcome

Express Settings

User Sign-In

Connect to Azure AD

Sync

Connect Directories

Azure AD sign-in

Domain/OU Filtering

Identifying users

Filtering

Optional Features

Configure

Connect to Azure AD

Enter your Azure AD credentials: ?

USERNAME

PASSWORD

Previous

Welcome

Express Settings

User Sign-In

Connect to Azure AD

Sync

Connect Directories

Azure AD sign-in

Domain/OU Filtering

Identifying users

Filtering

Optional Features

Configure

Connect your directories

Enter connection information for your on-premises directories or forests: ?

DIRECTORY TYPE

Active Directory

FOREST ?

Datacenter-Flo.local

USERNAME

DCF\administrator

PASSWORD

••••••••

Add Directory

CONFIGURED DIRECTORIES

Datacenter-Flo.local (Active Directory) ✓

Previous

- Welcome
- Express Settings
- User Sign-In
- Connect to Azure AD
- Sync
- Connect Directories
- Azure AD sign-in**
- Domain/OU Filtering
- Identifying users
- Filtering
- Optional Features
- Configure

Azure AD sign-in configuration

To use on-premises credentials for Azure AD sign-in, UPN suffixes in username should match to one of the verified custom domains in Azure AD. The following table lists the UPN suffixes defined in your on-premises environment, along with the matching custom domain in Azure. ?

| Active Directory UPN Suffix | Azure AD Domain |
|-----------------------------|-----------------|
| | Not Added ? |

Select the on-premises attribute to use as the Azure AD username

USER PRINCIPAL NAME ?

- userPrincipalName
- textEncodedORAddress
- title
- treeName
- unicodePwd
- unixHomeDirectory
- userParameters
- userPrincipalName**
- userSharedFolder
- userWorkstations
- whenCreated
- wwwHomePage

g their on-premises credentials.

Previous

Next

Do you use a top level
Directory Domain
(example: com)

No

Are you ok with
@company.onmicrosoft.com
as primary mail and login in
Azure AD?

No

Yes

Choose Mail

Choose User P

Microsoft Azure Active Directory Connect

Welcome
Express Settings
User Sign-In
Connect to Azure AD
Sync
Connect Directories
Azure AD sign-in
Domain/OU Filtering
Identifying users
Filtering
Optional Features
Configure

Domain and OU filtering

Directory: [Redacted] Refresh Ou/Domain ?

Sync all domains and OUs
 Sync selected domains and OUs

- Datacenter-Flo.local
 - Builtin
 - Computers
 - Domain Controllers
 - ForeignSecurityPrincipals
 - Infrastructure
 - LostAndFound
 - Managed Service Accounts
 - NTDS Quotas
 - Program Data
 - System
 - Users
 - Configuration

Previous Next

Welcome

Express Settings

User Sign-In

Connect to Azure AD

Sync

Connect Directories

Azure AD sign-in

Domain/OU Filtering

Identifying users

Filtering

Optional Features

Configure

Uniquely identifying your users

Select how users should be identified in your on-premises directories. ?

- Users are represented only once across all directories.
- User identities exist across multiple directories. Match using:
 - Mail attribute
 - ObjectSID and msExchMasterAccountSID/msRTCSIP-OriginatorSID attributes
 - SAMAccountName and MailNickName attributes
 - A specific attribute

CUSTOM ATTRIBUTE

Select how users should be identified with Azure AD.

SOURCE ANCHOR ?

Previous

- Welcome
- Express Settings
- User Sign-In
- Connect to Azure AD
- Sync
 - Connect Directories
 - Azure AD sign-in
 - Domain/OU Filtering
 - Identifying users
 - Filtering**
 - Optional Features
- Configure

Filter users and devices

For a pilot deployment, specify a group containing your users and devices that will be synchronized.

Synchronize all users and devices

Synchronize selected 

FOREST

[Redacted]

GROUP

[Redacted] \\R-Synch-0365,CN=Users,DC=[Redacted],DC=local

[Resolve](#)

Previous

Next

Welcome

Express Settings

User Sign-In

Connect to Azure AD

Sync

Connect Directories

Azure AD sign-in

Domain/OU Filtering

Identifying users

Filtering

Optional Features

Azure AD Apps

Azure AD Attributes

Directory Extensions

Configure

Optional features

Select enhanced functionality if required by your organization.

- Exchange hybrid deployment [?](#)
- Azure AD app and attribute filtering [?](#)
- Password synchronization [?](#)
- Password writeback [?](#)
- Group writeback (Preview) [?](#)
- Device writeback [?](#)
- Directory extension attribute sync [?](#)

[Learn more](#) about optional features

Previous

Welcome

Express Settings

User Sign-In

Connect to Azure AD

Sync

Connect Directories

Azure AD sign-in

Domain/OU Filtering

Identifying users

Filtering

Optional Features

Azure AD Apps

Azure AD Attributes

Directory Extensions

Configure

Azure AD apps

The information necessary to use the following apps will be exported to Azure AD. R required to meet strict organizational security policy.

AZURE AD APPS

- Office 365 ProPlus
- Exchange Online
- SharePoint Online
- Lync Online
- Azure RMS
- Intune
- Dynamics CRM
- 3rd party application

I want to restrict the list of applications. [?](#)

Previous

Welcome

Express Settings

User Sign-In

Connect to Azure AD

Sync

Connect Directories

Azure AD sign-in

Domain/OU Filtering

Identifying users

Filtering

Optional Features

Azure AD Apps

Azure AD Attributes

Directory Extensions

Configure

Azure AD attributes

These attributes will be exported to Azure AD based on the previously selected application. Only one individual attribute only if required to meet string organizational security policy.

EXPORTED ATTRIBUTES

- accountEnabled
- accountName
- assistant
- authOrig
- c
- cn
- co
- company
- countryCode
- dLMemRejectPerms
- dLMemSubmitPerms
- department
-

I want to further limit the attributes exported to Azure AD. [?](#)

[View the list of attribute as comma-separated values](#)

Previous

Welcome

Express Settings

User Sign-In

Connect to Azure AD

Sync

Connect Directories

Azure AD sign-in

Domain/OU Filtering

Identifying users

Filtering

Optional Features

Azure AD Apps

Azure AD Attributes

Directory Extensions

Configure

Directory extensions

Synchronize directory extension attributes from on-premises to Azure AD to make them available to cloud-based apps.

Available Attributes

- accountExpires (user) [LargeInteger]
- accountNameHistory (group) [String]
- accountNameHistory (user) [String]
- aCSPolicyName (user) [String]
- adminCount (group) [Integer]
- adminCount (user) [Integer]
- adminDescription (group) [String]
- adminDescription (user) [String]
- adminDisplayName (group) [String]
- adminDisplayName (user) [String]
- altSecurityIdentities (group) [String]
- altSecurityIdentities (user) [String]

Selected Attributes



Previous

Welcome

Express Settings

User Sign-In

Connect to Azure AD

Sync

Connect Directories

Azure AD sign-in

Domain/OU Filtering

Identifying users

Filtering

Optional Features

Azure AD Apps

Azure AD Attributes

Directory Extensions

Configure

Ready to configure

Once you click Install/Upgrade, we will do the following:

- Configure synchronization services on this computer
- Start the synchronization process when configuration completes.
- Enable staging mode: When selected, synchronization will not export any data to

Previous

Microsoft Azure Active Directory Connect

Tasks
Connect to Azure AD
Staging Mode
Configure

Configure staging mode

When staging mode is enabled, no data changes will be exported to Azure AD or on-premises AD DS. Password writeback and password synchronization will also be disabled.

Enable staging mode

Before you disable staging mode, ensure no other synchronization service is active and exporting to the same Azure AD directory.

Previous Next

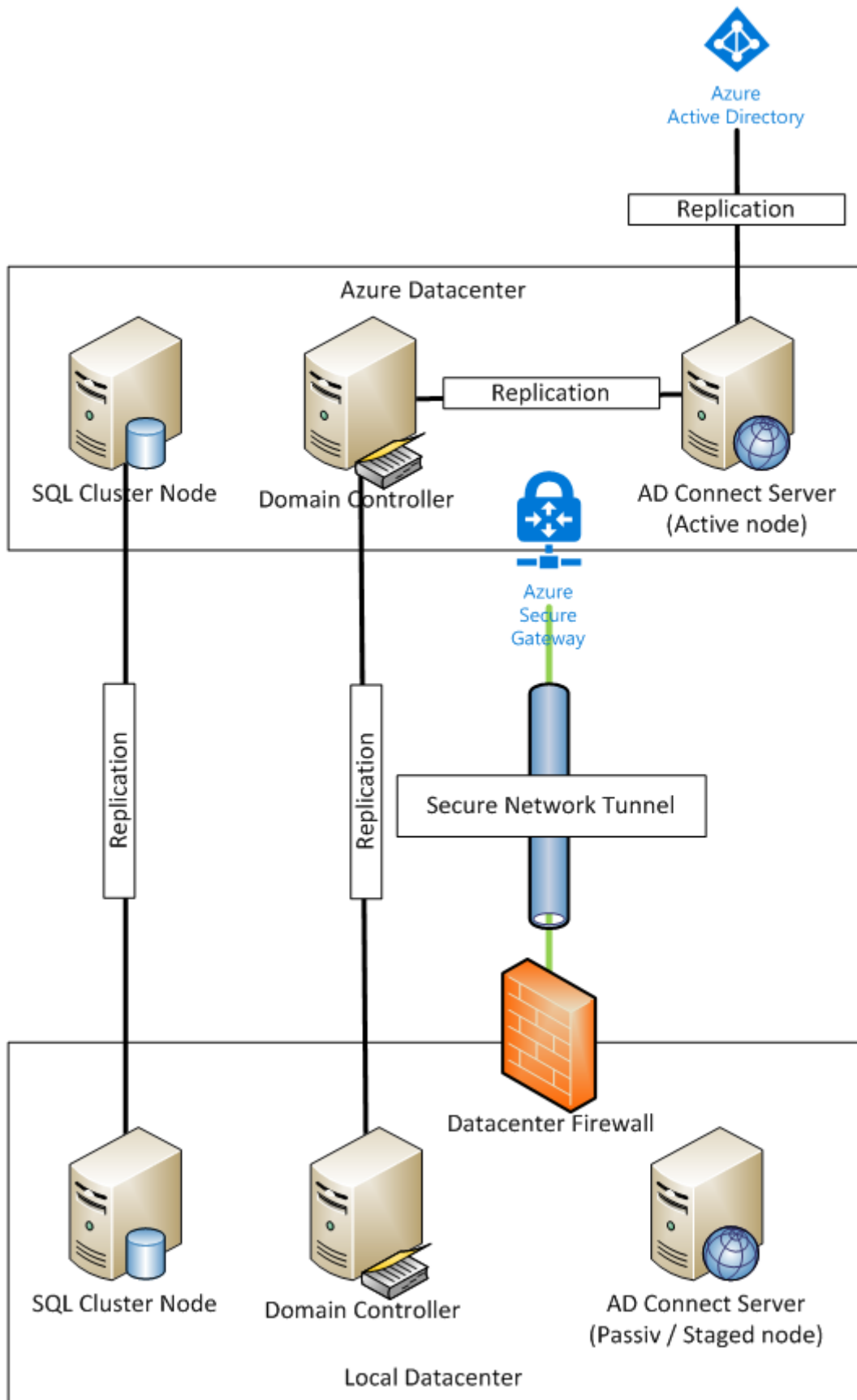

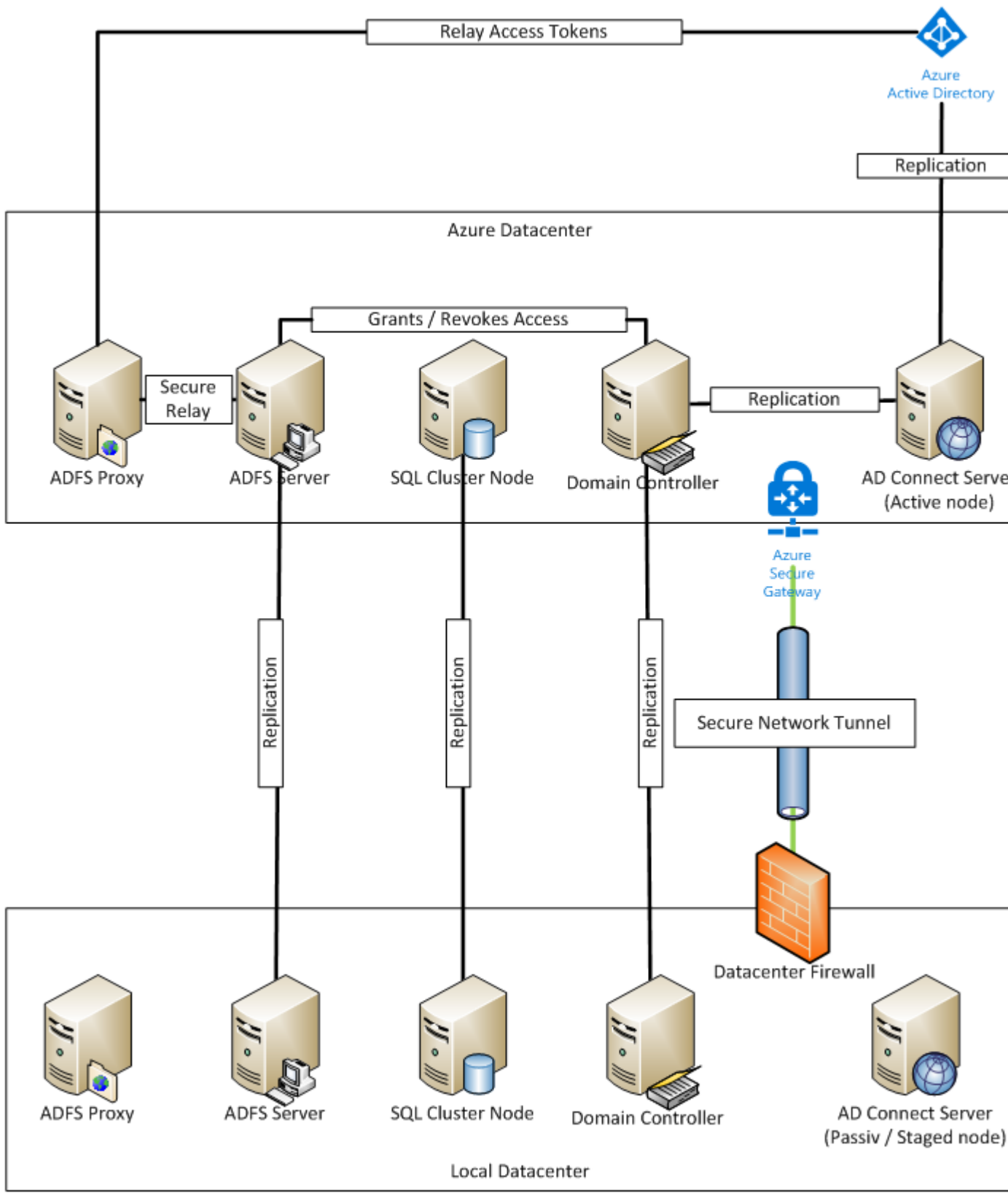

Chapter 4: Implementing Azure Networks

Virtual networks

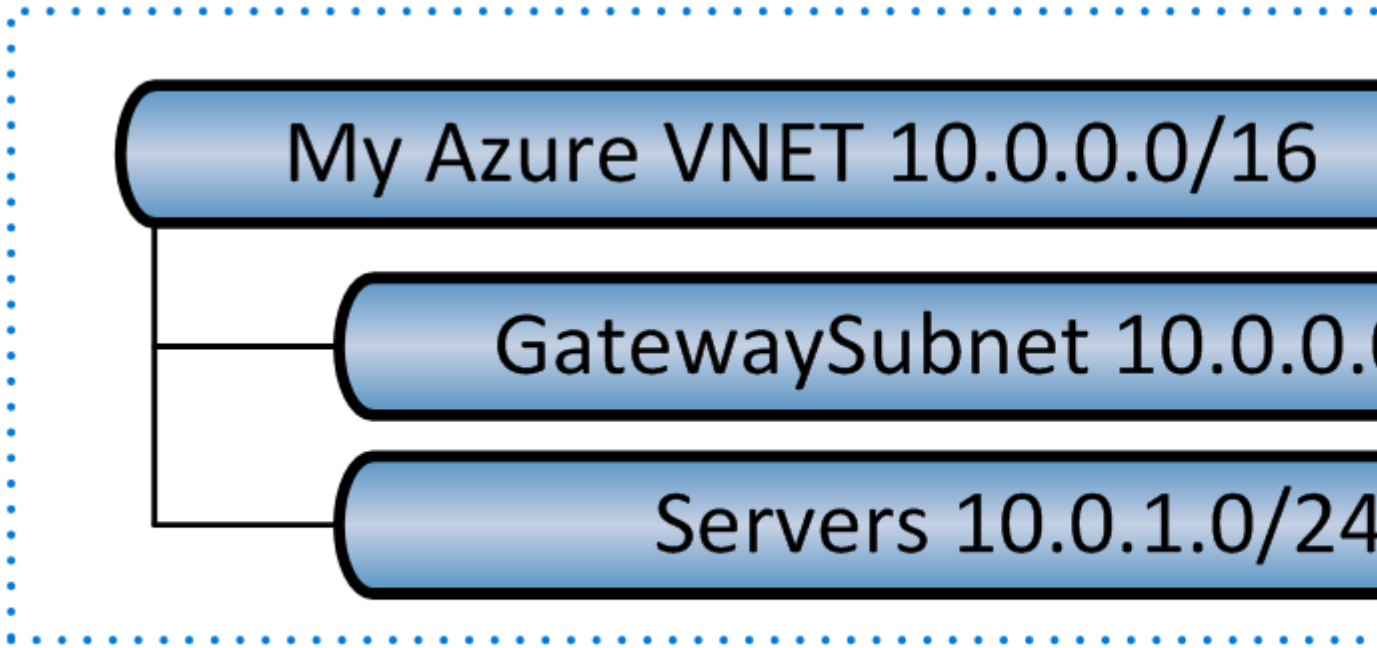

Frontend 11.0.1.0/24

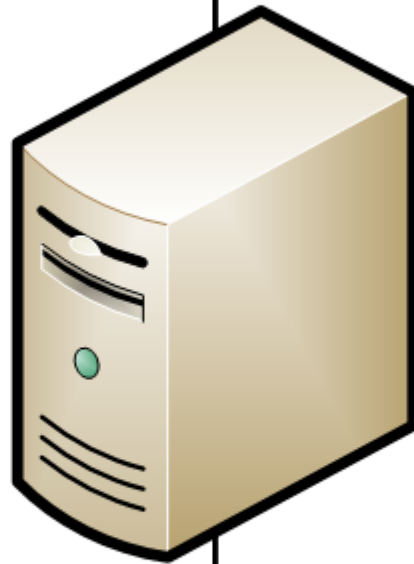

Backend 10.0.1.0/24



DCF-AWE-VN01 - Diagram

DCF-AWE-VN01

Refresh

Search (Ctrl+/)

Overview

Activity log

Access control (IAM)

Tags

SETTINGS

Address space

Connected devices

Subnets

DNS servers

Peerings

Properties

Locks

Automation script

MONITORING

Diagram

SUPPORT + TROUBLESHOOTING

New support request



GatewaySubnet 10.0.0.0/24



DCF-AWE-GW01

Gateway type
VPN

Public IP address
104.46.38.148



Server 10.0.1.0/24



No connected devices



Virtual network gateways

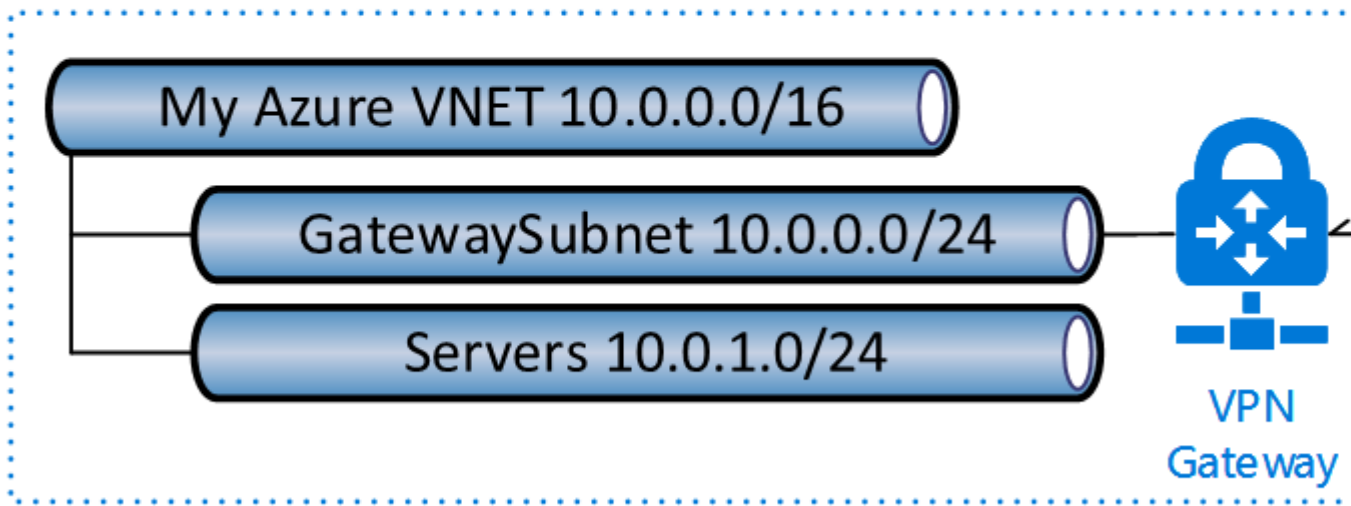

Virtu

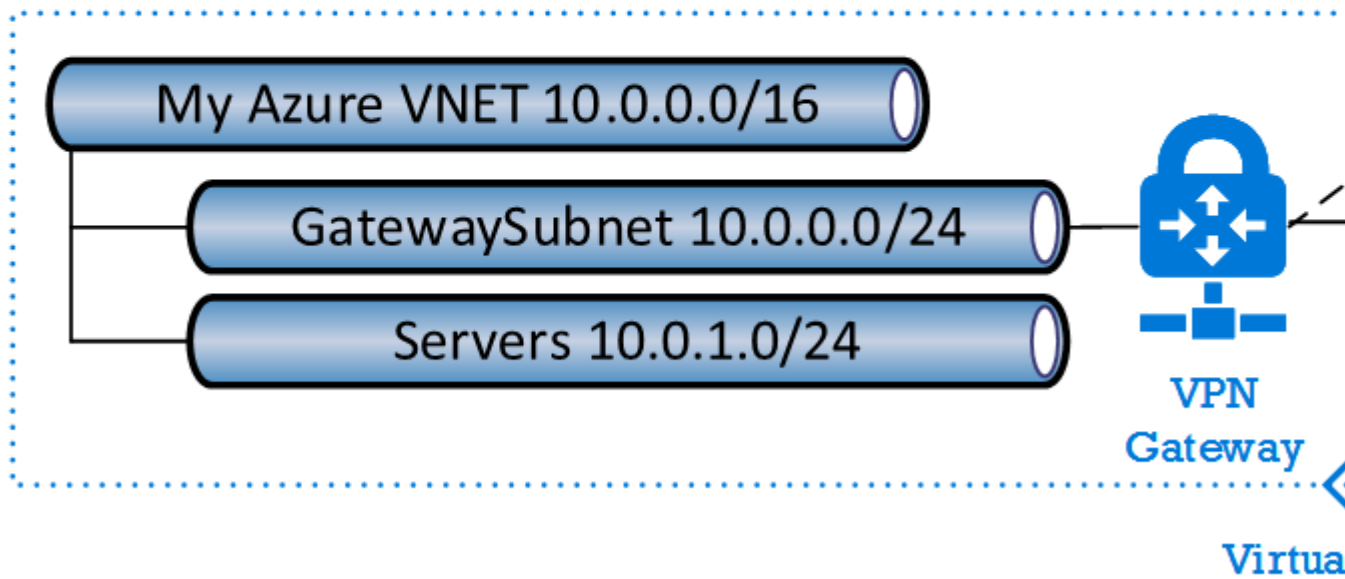

Gateway type ⓘ

VPN ExpressRoute

VPN type ⓘ

Route-based Policy-based

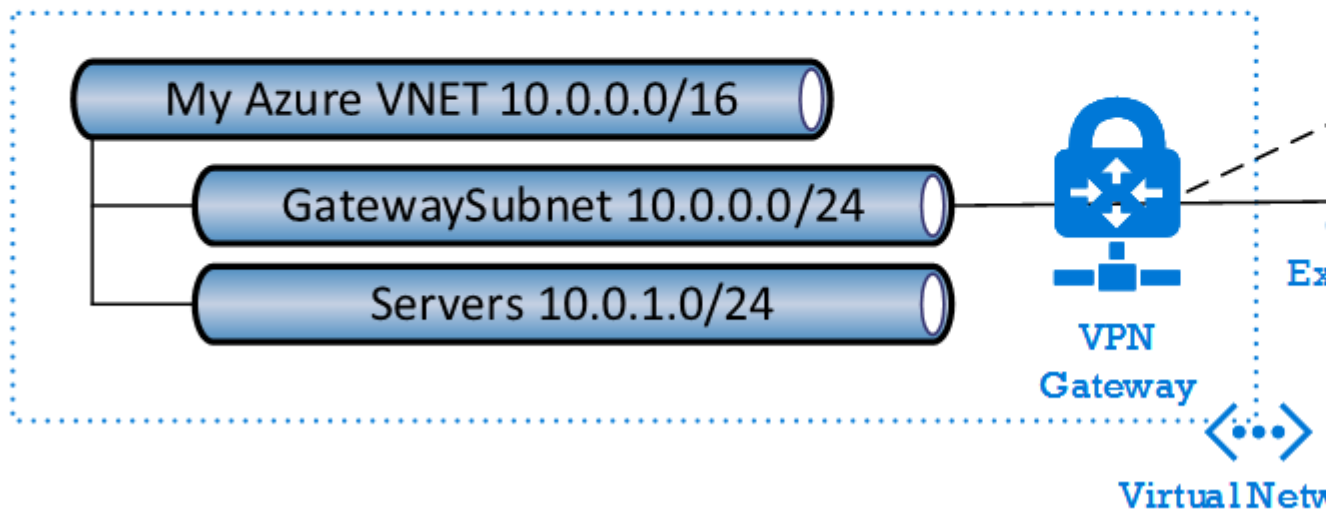

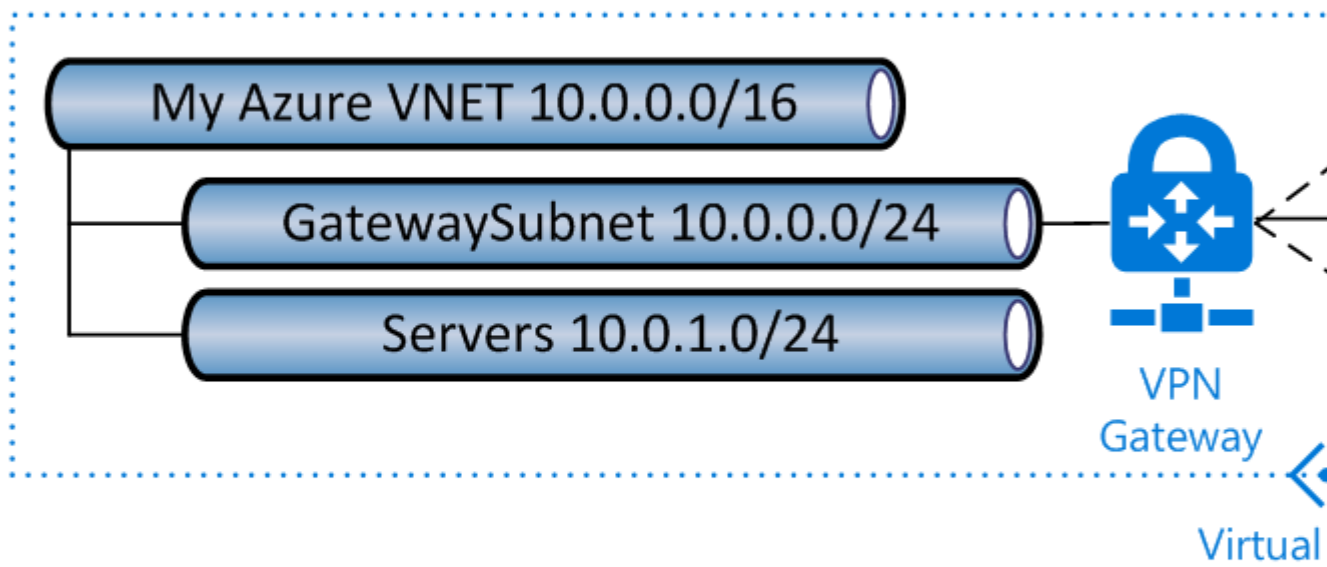

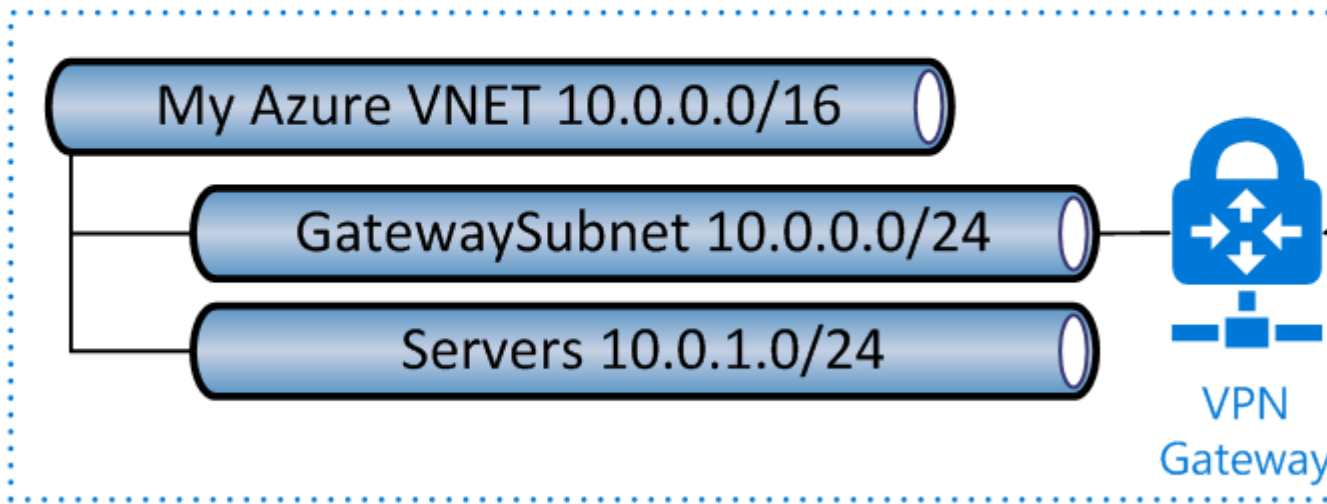

Virt

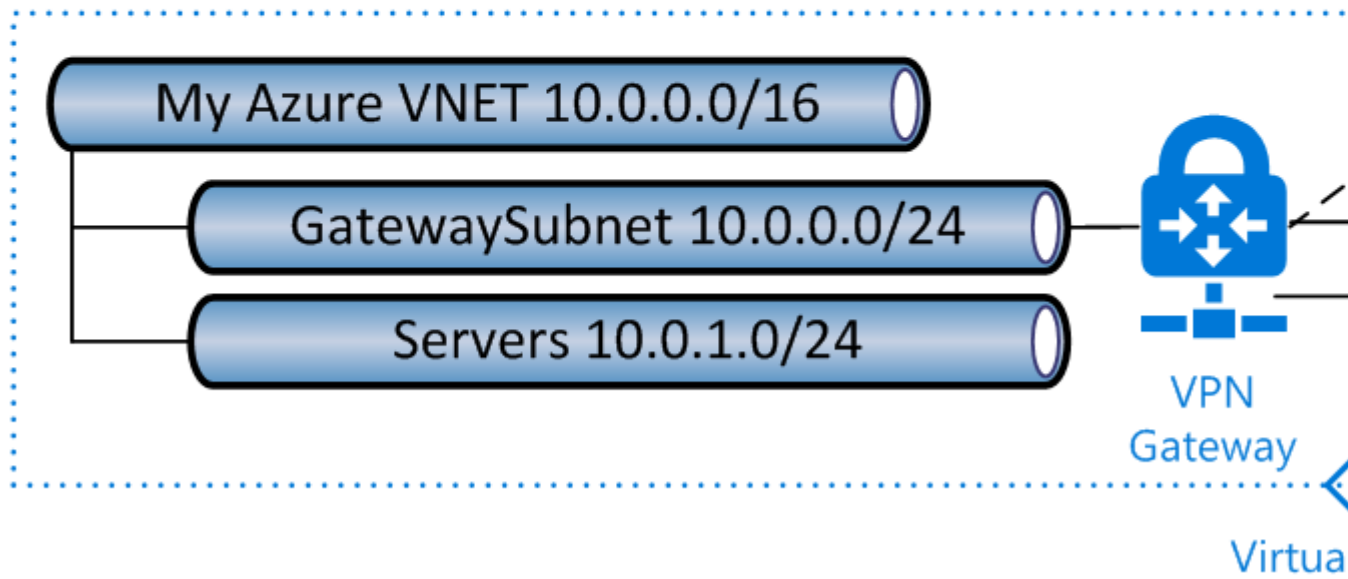

 Local network gateways

Create local network g... — □ ×

* Name

LocalNetworkGateway ✓

* IP address ⓘ

Address space ⓘ

192.168.10.0/24 ...

16.0.0.0/16 ...

Add additional address range ...

* Subscription

Visual Studio Premium with MSDN ▼

* Resource group ⓘ

Create new Use existing

DCF-AWE-RG01 ▼

* Location

West Europe ▼

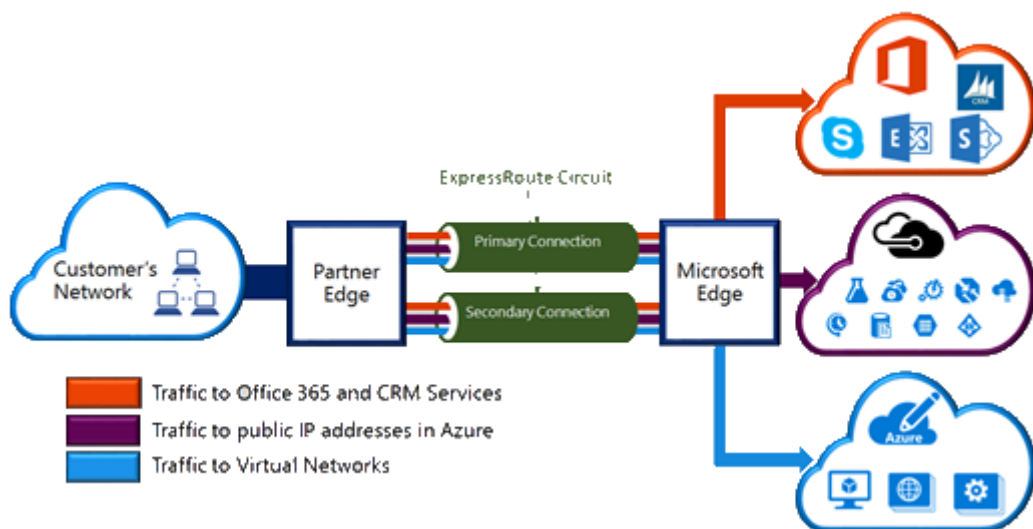
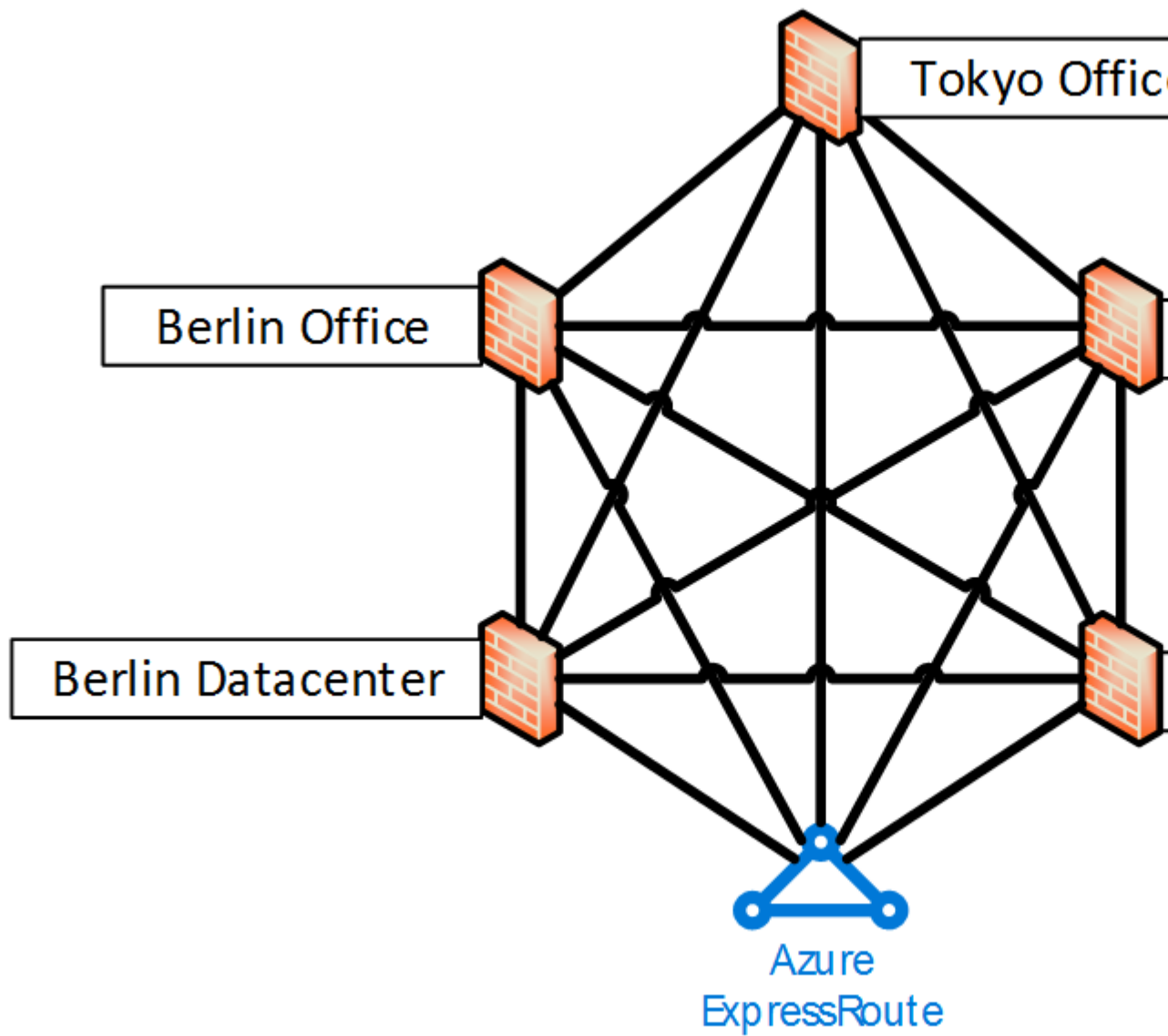

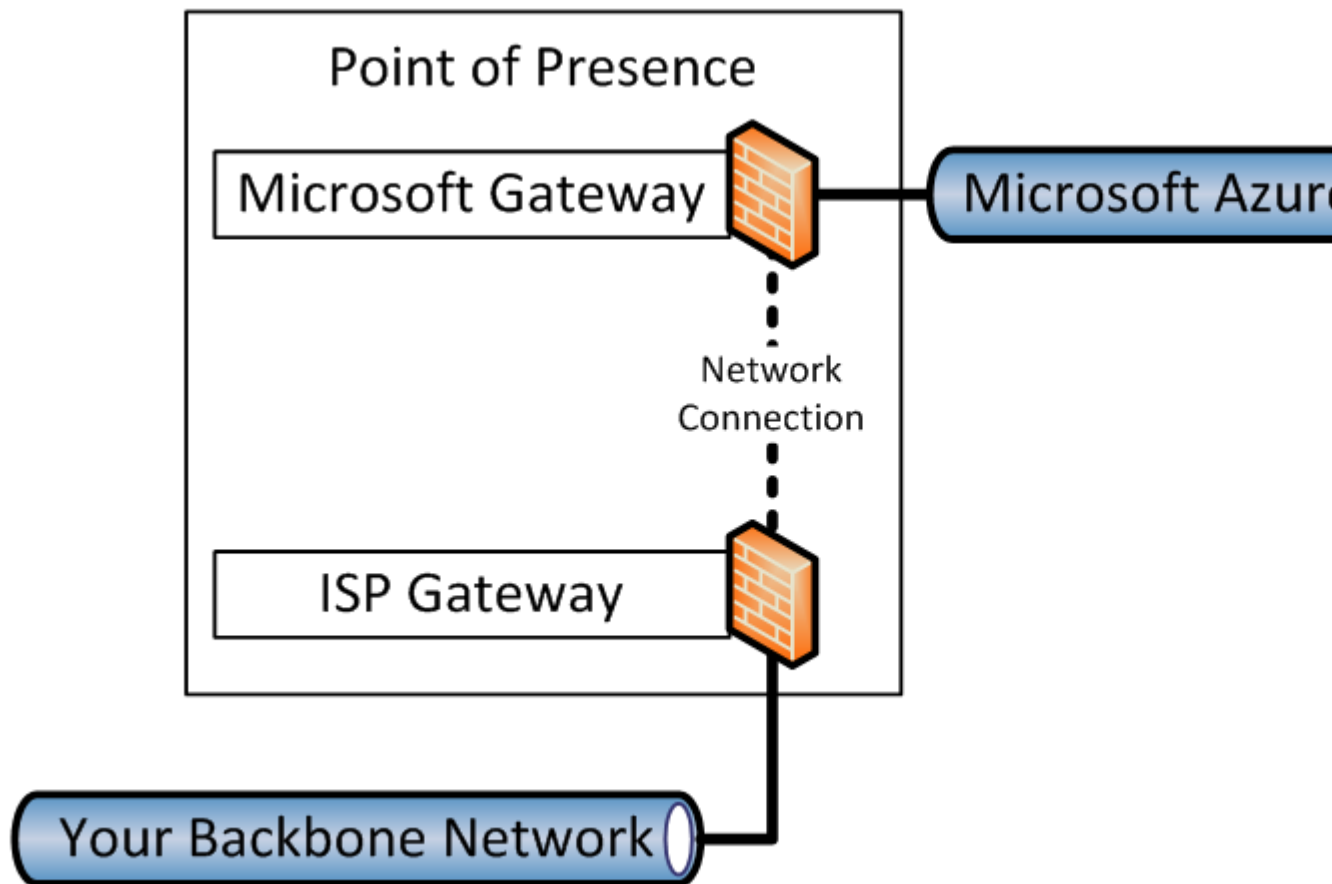

 ExpressRoute circuits

 Connections

- * Connection type ⓘ
- VNet-to-VNet
 - Site-to-site (IPsec)
 - ExpressRoute

 Route tables

* Route name

test ✓

* Address prefix ⓘ

192.168.16.0/24 ✓

Next hop type ⓘ

Virtual network gateway

Virtual network

Internet

Virtual appliance













None

Everything

Filter

barracuda

Results

| NAME | PUBLISHER | CA |
|--|--------------------------|----|
|  Barracuda NextGen Control Center (BYOL) | Barracuda Networks, Inc. | Vi |
|  Barracuda Message Archiver (BYOL) | Barracuda Networks, Inc. | Vi |
|  Barracuda Web Application Firewall (BYOL) | Barracuda Networks, Inc. | Vi |
|  Barracuda Web Application Firewall (PAYG) | Barracuda Networks, Inc. | Vi |
|  Barracuda NextGen Firewall F-Series (PAYG) | Barracuda Networks, Inc. | Vi |
|  Barracuda Email Security Gateway (BYOL) | Barracuda Networks, Inc. | Vi |
|  Barracuda Email Security Gateway (PAYG) | Barracuda Networks, Inc. | Vi |
|  Barracuda NextGen Firewall F-Series (BYOL) | Barracuda Networks, Inc. | Vi |
|  Barracuda Web Application Firewall Solution (PAYG) | Barracuda Networks, Inc. | Vi |
|  Barracuda Web Application Firewall Solution (BYOL) | Barracuda Networks, Inc. | Vi |
|  VNS3:net Lite (Firewall/VPN) | Cohesive Networks | Vi |
|  VNS3:vpn (Firewall/VPN) | Cohesive Networks | Vi |

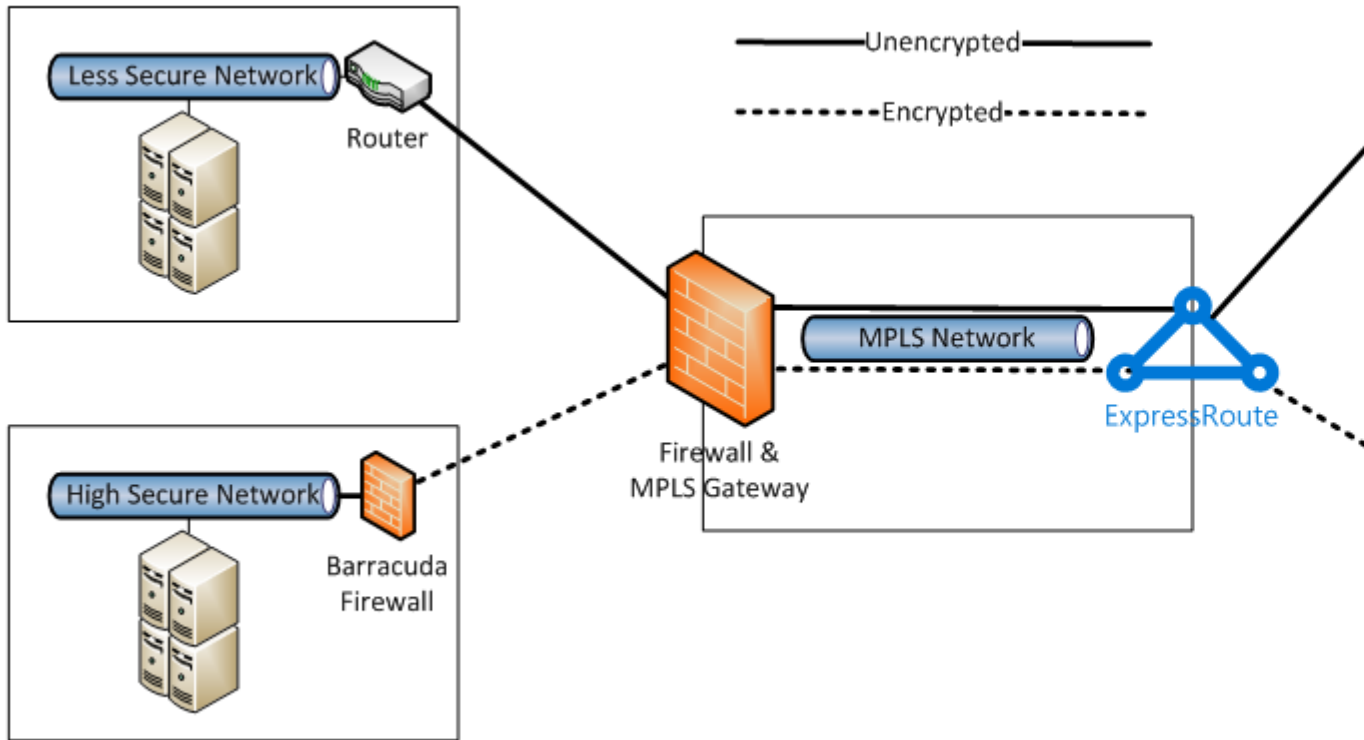



 **Barracuda NextGen Control Center (BYOL)**
Barracuda Networks, Inc.

Bring Your Own License enabled.

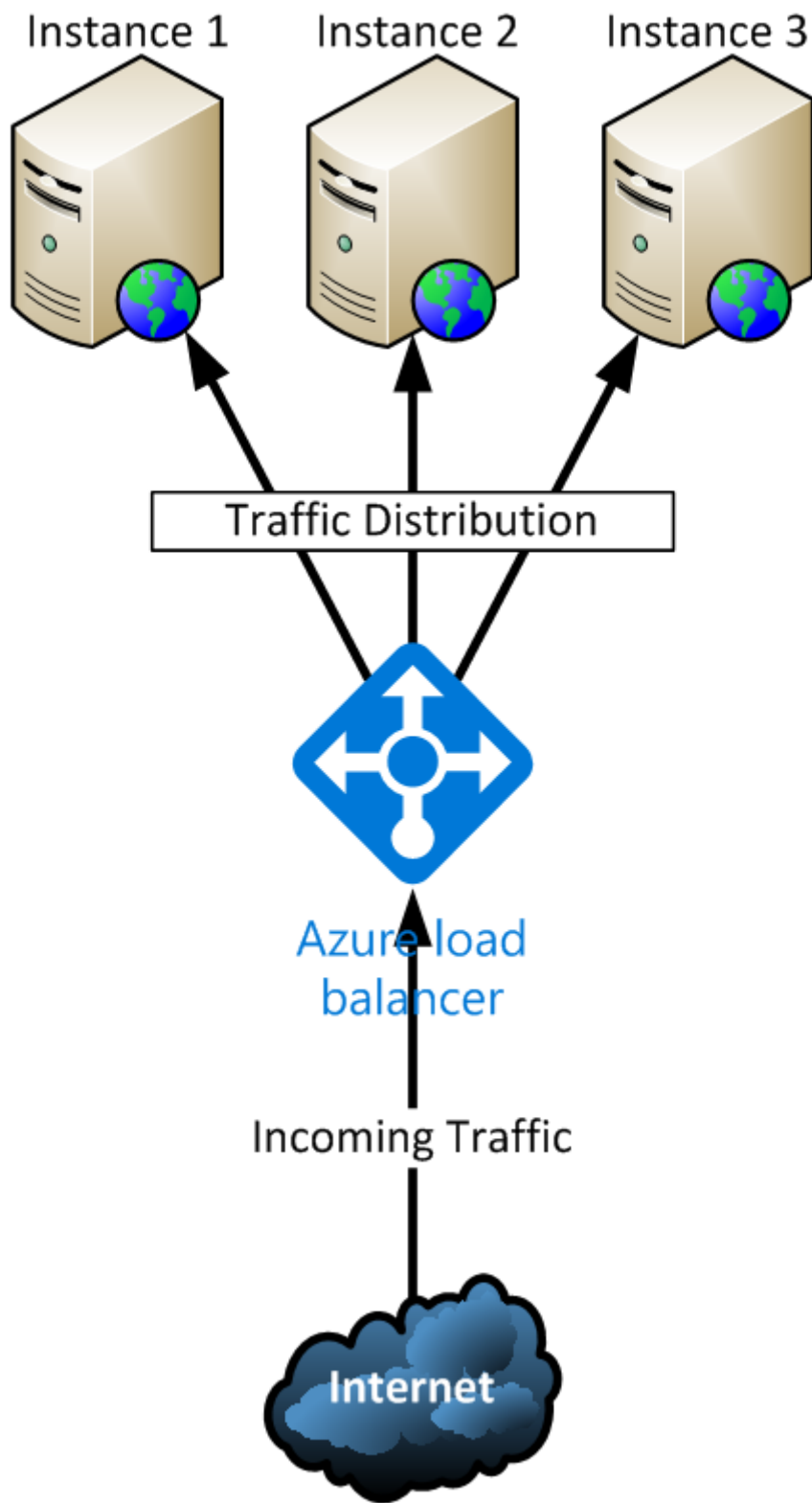
- This Barracuda NextGen Control Center is licensed using the Bring-Your-Own-License (BYOL) model. [Fill out the evaluation form](#) to receive a 30-day evaluation license or purchase one of the licenses depending on your requirement.



 Application gateways

 Traffic Manager profiles

Everything

Filter

Virtual network

Results

| NAME | PUBLISHER |
|-------------------------|-----------|
| Virtual network gateway | Microsoft |
| Virtual network | Microsoft |
| Network interface | Microsoft |

Select a deployment model ⓘ

Resource Manager

Create

Create virtual network

* Name

DCF-ANE-VN01 ✓

* Address space ⓘ

16.0.0.0/16 ✓

16.0.0.0 - 16.0.255.255 (65536 addresses)

* Subnet name

Server ✓

* Subnet address range ⓘ

16.0.1.0/24 ✓

16.0.1.0 - 16.0.1.255 (256 addresses)

* Subscription

Visual Studio Enterprise ▼

* Resource group ⓘ

Create new Use existing

DCF-ANE-RG01 ▼

* Location

North Europe ▼

Pin to dashboard

Create

[Automation options](#)

+ Add Columns Delete Refresh Move

Essentials ^

Subscription name
Visual Studio Enterprise
Last deployment
No deployments

Subscription ID
43b8966b-fc55-463a-835c-c3f6181b9382
Location
North Europe

Filter items...

NAME

TYPE

LOCATION

<--> DCF-ANE-VN01

Virtual network North Europe

...

Essentials ^

Subscription name: **Visual Studio Enterprise**
Subscription ID: 43b8966b-fc55-463a-835c-c3f6181b9382
Last deployment: **No deployments**
Location: North Europe

Filter items...

| NAME | TYPE | LOCATION | |
|--|-----------------|--------------|-----|
|  DCF-ANE-VN01 | Virtual network | North Europe | ... |

DCF-ANE-VN01
Virtual network

Search (0)

- Overview
- Activity log
- Access control
- Tags

SETTINGS

- Address spaces
- Connectivity
- Subnets
- DNS servers
- Peerings
- Properties
- Locks
- Automation

MONITORING

- Diagram

SUPPORT + TROUBLESHOOTING

- New support request

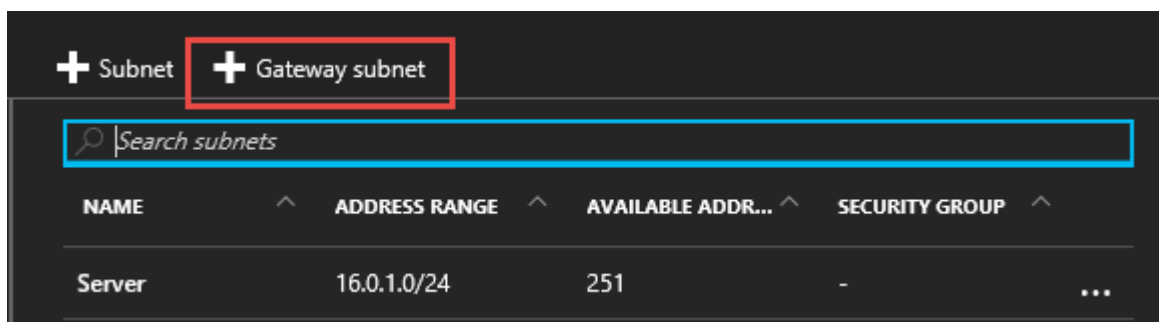
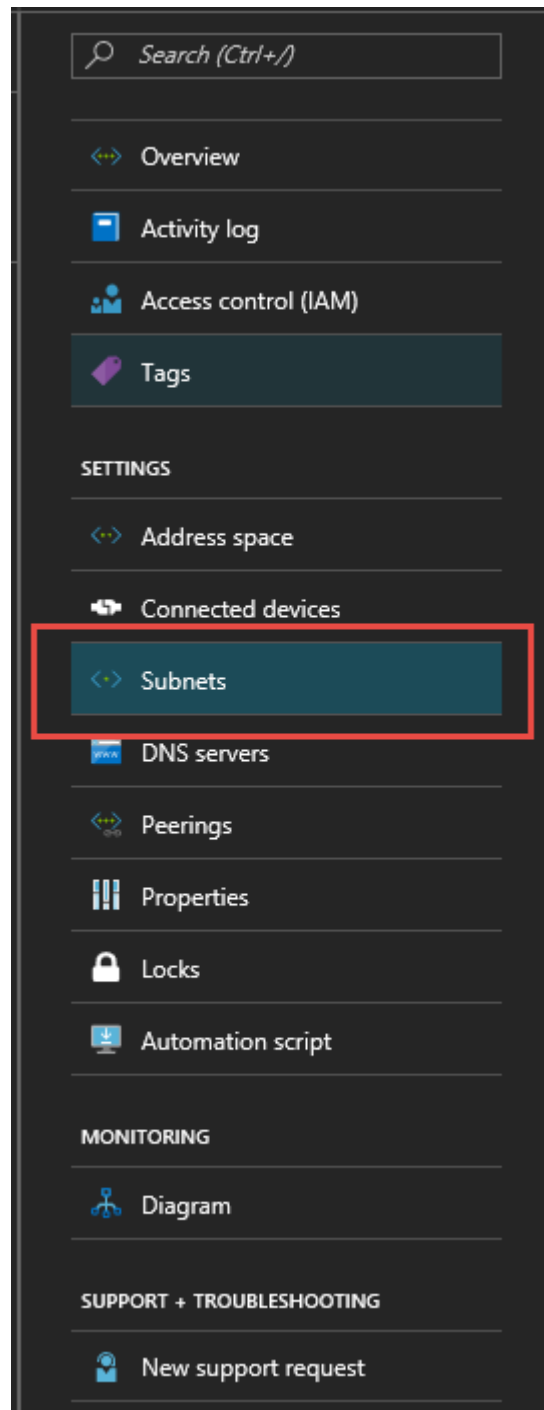

* Name
GatewaySubnet

* Address range (CIDR block) ⓘ
16.0.0.0/24 ×
16.0.0.0 - 16.0.0.255 (256 addresses)

Route table
None >

+ Subnet + Gateway subnet

Search subnets

| NAME | ADDRESS RANGE | AVAILABLE ADDR... | SECURITY GROUP |
|---------------|---------------|-------------------|----------------|
| Server | 16.0.1.0/24 | 251 | - |
| GatewaySubnet | 16.0.0.0/24 | 251 | - |

- Search (Ctrl+/)
- Overview
 - Activity log
 - Access control (IAM)
 - Tags
- SETTINGS
- Address space
 - Connected devices
 - Subnets
 - DNS servers**
 - Peerings

Save Discard

DNS servers ⓘ

Azure DNS Custom DNS

Save Discard

DNS servers ⓘ

Azure DNS Custom DNS

* Primary DNS server

16.0.1.10 ✓

Secondary DNS server

16.0.1.11 ✓

+ Add Columns Delete Refresh Move Filter

Essentials ^

Subscription name: Visual Studio Enterprise
Subscription ID: 43b8966b-fc55-463a-835c-c3f6181b9382
Last deployment: 9/5/2016 (Succeeded)
Location: North Europe

Filter items...

| NAME | TYPE | LOCATION |
|--------------|-----------------|--------------|
| DCF-ANE-VN01 | Virtual network | North Europe |

local network

Results

NAME

- Local network
- Virtual network
- Connectivity

Create local network g... — □

* Name

DCF-ANE-LG01 ✓

* IP address ⓘ

Address space ⓘ

192.168.0.0/16 ...

172.25.0.0/16 ...

Add additional address range ...

* Subscription

Visual Studio Enterprise ▼

* Resource group ⓘ

Create new Use existing

DCF-ANE-RG01 ▼

* Location

North Europe ▼

Pin to dashboard

Create

[Automation options](#)

 Add  Columns  Delete  Refresh  Move

Essentials ^

Subscription name
Visual Studio Enterprise
Last deployment
9/5/2016 (Succeeded)

Subscription ID
 **43b8966b-fc55-463a-835c-c3f6181b9382**
Location
North Europe

Filter items...

| NAME | TYPE | LOCATION | |
|--|-----------------|--------------|-----|
|  DCF-ANE-VN01 | Virtual network | North Europe | ... |

 Filter

 virtual netw

Results

NAME

 Virtual ne

 Virtual ne

 Network

Create virtual network gate... □ ×

* Name ⓘ

Gateway type ⓘ

VPN ExpressRoute

VPN type ⓘ

Route-based Policy-based

* SKU ⓘ

Standard ▾

* Virtual network ⓘ

Choose a virtual network ➤

* Public IP address ⓘ

Choose a public IP address ➤

* Subscription

Visual Studio Enterprise ▾

Resource group ⓘ

-

* Location ⓘ

West Europe ▾

Pin to dashboard

Create

[Automation options](#)

Provisioning a virtual network gateway may take up to 45 minutes.

* Name

* Virtual network ⓘ
DCF-ANE-VN01

* Public IP address ⓘ
Choose a public IP address

the selected subscription and location 'North Europe'.

DCF-ANE-VN01
DCF-ANE-RG01

* Virtual network ⓘ
DCF-ANE-VN01

* Public IP address ⓘ
Choose a public IP address

+ Create new

No results

Create public IP address

* Name

Gateway type ⓘ

VPN ExpressRoute

VPN type ⓘ

Route-based Policy-based

Pin to dashboard

Create [Automation options](#)

Provisioning a virtual network gateway may take up to 45 minutes.

+ Add ≡ Columns 🗑️ Delete ↻ Refresh → Move

Essentials ^

Subscription name [\(change\)](#)

Visual Studio Enterprise

Deployments

1 Deploying, 1 Failed, 16 Succeeded

Subscription

43b8966b

Location

West Euro

Filter by name...

4 items

NAME ▾

TYPE ▾

 DCF-Demo-RV01

Recovery Ser

 GW01

Virtual netwo

 GW01-PIP

Public IP add





 VN01

Virtual netwo







GW01 - Configuration

Virtual network gateway



 Search (Ctrl+/)

-  Overview
-  Activity log
-  Access control (IAM)
-  Tags
-  Diagnose and solve problems

SETTINGS

-  Configuration **1**
-  Connections
-  Point-to-site configuration
-  Properties
-  Locks
-  Automation script

SUPPORT + TROUBLESHOOTING

-  Resource health
-  Reset
-  New support request

 Save  Discard

* SKU

- Basic
- Standard
- High performance

2

+ Add Columns Delete Refresh Move Filter

Essentials ^

| | |
|--|---|
| Subscription name Visual Studio Enterprise | Subscription ID 43b8966b-fc55-463a-835c-c3f6181b9382 |
| Last deployment 9/5/2016 (Succeeded) | Location North Europe |

Filter items...

Results

NAME

Connect

Create connection Basics

- 1 Basics
Configure basic settings
- 2 Settings
Configure connection settings
- 3 Summary
Review and create

* Connection type
Site-to-site (IPsec)

* Subscription
Visual Studio Enterprise

* Resource group
 Create new Use existing
DCF-ANE-RG01

* Location
North Europe

Create connection Settings Choose

- 1 Basics
Configure basic settings ✓
- 2 Settings
Configure connection settings

* Virtual network gateway
Choose a virtual network gateway

* Local network gateway
Choose a local network gateway

* Connection name

To use a virtual network gateway connection

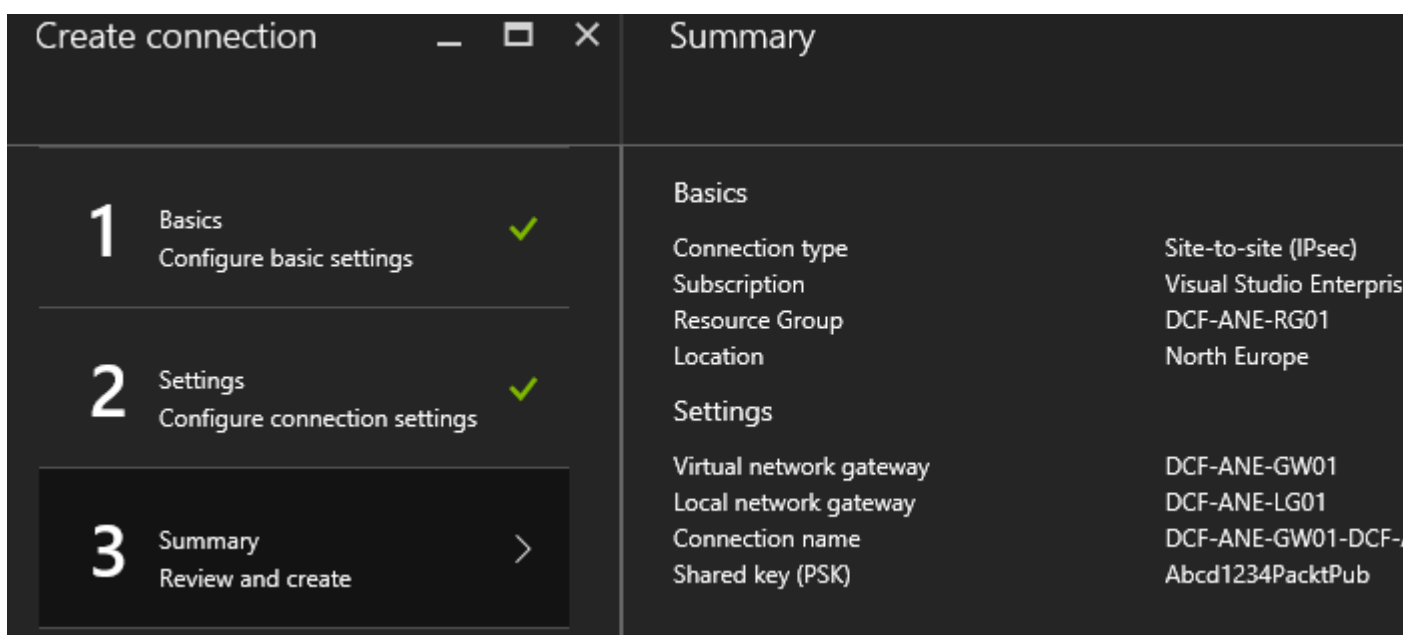
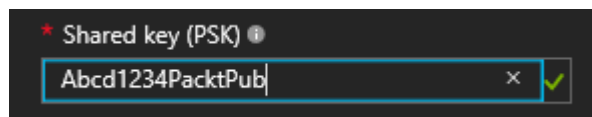
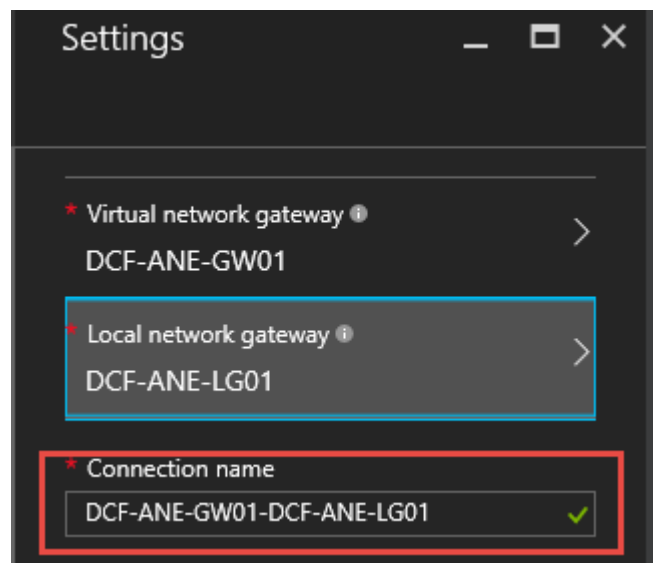
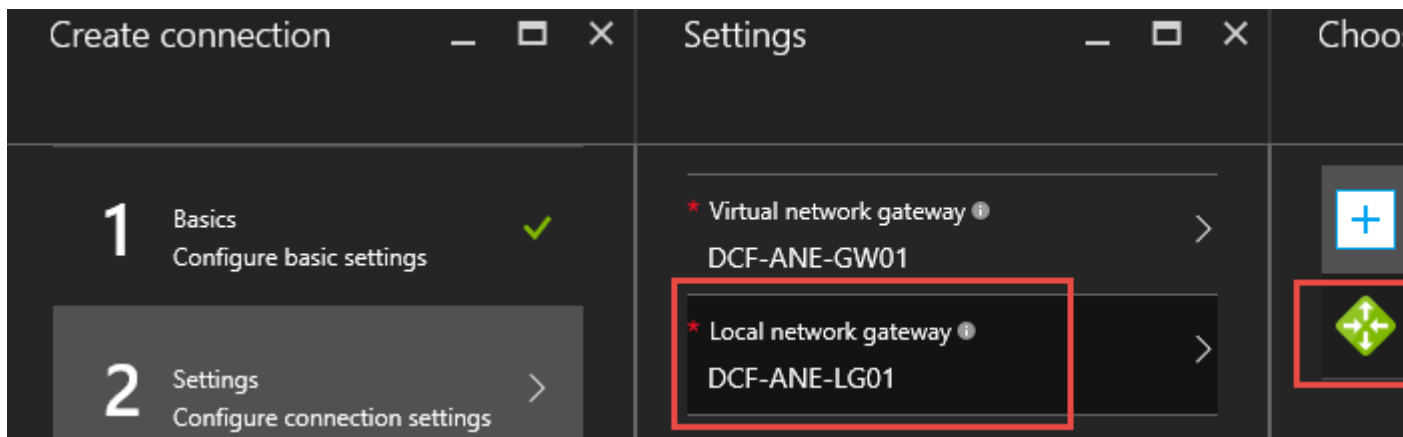

DCF-ANE-RG01
Resource group

+ Add Columns Delete Refresh Move

Search (Ctrl+/)

- Overview
- Activity log
- Access control (IAM)
- Tags

SETTINGS

- Quickstart
- Resource costs

Essentials ^

Subscription name: **Visual Studio Enterprise** Subscription ID: 43b8966b-fc55-463a-83...

Last deployment: 9/10/2016 (Succeeded) Location: North Europe

Filter items...

| NAME | TYPE | LOCATI |
|---------------------------|-------------------|--------|
| DCF-ANE-GW01-DCF-ANE-LG01 | Connection | North |
| DCF-ANE-LG01 | Local network... | North |
| DCF-ANE-GW01-PIP | Public IP addr... | North |

DCF-ANE-GW01-DCF-ANE-LG01
Connection

Delete

Search (Ctrl+/)

- Overview
- Activity log
- Access control (IAM)
- Tags

SETTINGS

Essentials ^







Resource group: **DCF-ANE-RG01** Data in: 0 B

Status: **Connecting** Data out: 0 B

Location: **North Europe** Virtual network: **DCF-ANE-VN01**

Subscription name: **Visual Studio Enterprise** Virtual network gateway: **DCF-ANE-GW01 (52.178...**

Subscription ID: 43b8966b-fc55-463a-835c-c3f6181b9382 Local network gateway: **DCF-ANE-LG01 (91.65.8...**

| NAME | | TYPE | LOCATION | |
|---|---|--------------------|--------------|-----|
|  DCF-ANE-GW01-DCF-ANE-LG01 | 4 | Connection | North Europe | ... |
|  DCF-ANE-GW01-DCF-ANE-LG02 | | Connection | North Europe | ... |
|  DCF-ANE-LG01 | 3 | Local network... | North Europe | ... |
|  DCF-ANE-LG02 | | Local network... | North Europe | ... |
|  DCF-ANE-GW01-PIP | 2 | Public IP addr... | North Europe | ... |
| [Redacted] | | | | |
|  DCF-ANE-GW01 | 1 | Virtual network... | North Europe | ... |
| [Redacted] | | | | |
|  DCF-ANE-VN01 | | Virtual network | North Europe | ... |
| [Redacted] | | | | |

Create virtual network gate... ☐ ✕

* Name ⓘ

Gateway type ⓘ

VPN

ExpressRoute

* SKU ⓘ

Standard ▾

* Virtual network ⓘ

Choose a virtual network ➤

* Public IP address ⓘ

Choose a public IP address ➤

* Subscription

Visual Studio Enterprise ▾

Resource group ⓘ

-

* Location ⓘ

West Europe ▾



Add

Columns

Delete

Refresh

Move

Essentials ^

Subscription name

Visual Studio Enterprise

Last deployment

9/11/2016 (Succeeded)

Subscription ID

43b8966b-fc55-463a-835c-c3f6181b9382

Location

North Europe

Filter items...

| NAME | TYPE | LOCATION | |
|---------------------------|------------------|--------------|-----|
| DCF-ANE-GW01-DCF-ANE-LG01 | Connection | North Europe | ... |
| DCF-ANE-GW01-DCF-ANE-LG02 | Connection | North Europe | ... |
| DCF-ANE-LG01 | Local network... | North Europe | ... |
| DCF-ANE-LG02 | Local network... | North Europe | ... |

Filter

ExpressRo

Results

NAME

ExpressF

Virtual n

App Ser

Connect

BizTalk3

Create ExpressRoute ci... — □ ×

Create new or import from classic ⓘ

Create new Import

* Circuit name ⓘ

DCF-ANE-EX01 ✓

* Provider ⓘ

Equinix ▼

* Peering location ⓘ

Amsterdam ▼

* Bandwidth ⓘ

50Mbps ▼

* SKU ⓘ

Standard Premium

* Billing model ⓘ

Unlimited **Metered**

Allow classic operations ⓘ

* Subscription

Visual Studio Enterprise ▼

* Resource group ⓘ

Create new Use existing

DCF-ANE-RG01 ▼

* Location

North Europe ▼

Pin to dashboard

Create

[Automation options](#)



DCF-ANE-EX01

ExpressRoute circuit

Delete

Search (Ctrl+)

Overview

Activity log

Access control (IAM)

Tags

Diagnose and solve problems

SETTINGS

Configuration

Connections

Peerings

Properties

Locks

Automation script

SUPPORT + TROUBLESHOOTING

New support request

Initiate the provisioning process with your service provider.

Essentials

Resource group
DCF-ANE-RG01

Circuit status
Enabled

Location
North Europe

Subscription name
Visual Studio Enterprise

Subscription ID
43b8966b-fc55-463a-835c-c3f6181b9382

Provider
Equinix

Provider status
Not provisioned

Peering location
Amsterdam

Bandwidth
50 Mbps

Service key
2c3b3488-2f70-48d6-a2

Peerings

| TYPE | STATUS | PRIMARY SUBNET | SECONDARY |
|---------------|----------|----------------|-----------|
| Azure private | Disabled | - | - |
| Azure public | Disabled | - | - |
| Microsoft | Disabled | - | - |

Resource group

Circuit status
Enabled

Location
West Europe

Subscription name
Azure in Open

Subscription ID

Provider
Equinix

Peering location
Amsterdam

Bandwidth
200 Mbps

Service key

* Peer ASN ⓘ

0

* Primary subnet ⓘ

* Secondary subnet ⓘ

* VLAN ID ⓘ

0

* Advertised public prefixes ⓘ

Status: Not configured

Customer ASN ⓘ

0

Routing registry name ⓘ

None



Shared key

Essentials ^

| | |
|----------------------|--------------------|
| Resource group | Provider |
| [REDACTED] | Equinix |
| Circuit status | Provider status |
| Enabled | Provisioned |
| Location | Peering location |
| West Europe | Amsterdam |
| Subscription name | Bandwidth |
| Azure in Open | 200 Mbps |
| Subscription ID | Service key |
| [REDACTED] | [REDACTED] |

Peerings

| TYPE ^ | STATUS ^ | PRIMARY SUBNET ^ | SECONDARY SUBNET ^ | |
|---------------|----------|------------------|--------------------|-----|
| Azure private | Enabled | [REDACTED] | [REDACTED] | ... |
| Azure public | Disabled | - | - | ... |
| Microsoft | Disabled | - | - | ... |

Private peering

WH-AWE-ER01

Save Discard Delete

* Peer ASN ⓘ
9999

* Primary subnet ⓘ
213.56.34.15/30

* Secondary subnet ⓘ
203.66.34.15/30

* VLAN ID ⓘ
99

Shared key

+ Add Columns Delete Refresh Move Filter

Essentials ^

| | |
|--|---|
| Subscription name Visual Studio Enterprise | Subscription ID 43b8966b-fc55-463a-835c-c3f6181b9382 |
| Last deployment 9/5/2016 (Succeeded) | Location North Europe |

Filter items...

Filter

Connection

Results

NAME

Connect

Create connection Basics

- 1 Basics**
Configure basic settings
- 2 Settings
Configure connection settings
- 3 Summary
Review and create

* Connection type
ExpressRoute

* Subscription
Visual Studio Enterprise

* Resource group
 Create new Use existing
DCF-ANE-RG01

* Location
North Europe

- 1 Basics** ✓
Configure basic settings
- 2 Settings
Configure connection settings
- 3 Summary
Review and create

* Virtual network gateway
DCF-ANE-GW03

* ExpressRoute circuit
Choose a circuit

* Connection name



ExpressRoute circuit

Delete

Search (Ctrl+)

Overview

Activity log

Access control (IAM)

Tags

Diagnose and solve problems

SETTINGS

Configuration

Connections

Peerings

Properties

Locks

Automation script

SUPPORT + TROUBLESHOOTING

New support request

Essentials ^

Resource group

Circuit status
Enabled

Location
West Europe

Subscription name
Azure in Open

Subscription ID

Provider

Equinix

Provider status

Provisioned

Peering location

Amsterdam

Bandwidth

200 Mbps

Service key

Peerings

| TYPE ^ | STATUS ^ | PRIMARY SUBNET ^ | SECONDARY ^ |
|---------------|----------|------------------|-------------|
| Azure private | Enabled | | |
| Azure public | Disabled | - | - |
| Microsoft | Disabled | - | - |

| | |
|---|---|
| Resource group DCF-AWE-RG01 | Address space 10.0.0.0/16 |
| Location West Europe | DNS servers Azure provided DNS service |
| Subscription name Visual Studio Premium with MSDN | |
| Subscription ID [REDACTED] | |

| | |
|--|---|
| Resource group DCF-AWE-RG02 | Address space 17.0.0.0/16 |
| Location West Europe | DNS servers Azure provided DNS service |
| Subscription name Visual Studio Enterprise | |
| Subscription ID [REDACTED] | |

+ Add Columns Delete Refresh Move

Essentials ^

Subscription name
Visual Studio Enterprise

Subscription ID
 43b8966b-fc55-463a-835c-c3f6181b9382

Last deployment
 9/17/2016 (Succeeded)

Location
West Europe

Filter items...

| NAME | TYPE | LOCATION |
|--------------|-----------------|-------------|
| DCF-AWE-VN01 | Virtual network | West Europe |

Search
 Overview
 Activity
 Access
 Tags

SETTINGS

Address
 Connected
 Subnet
 DNS se
 Peerin
Property

DCF-AWE-VN01 - Properties

Virtual network

Search (Ctrl+/)

- Overview
- Activity log
- Access control (IAM)

RESOURCE ID

`/subscriptions/43b8966b-fc55-463a-835c` 

[Change subscription](#)

LOCATION

West Europe

+ Add Columns Delete Refresh Move

Essentials







Subscription name: **Visual Studio Premium with MSDN**

Subscription ID: `4a8a0611-6c01-4199-ba5e-2ca0700a1c54`

Last deployment: **8/29/2016 (Succeeded)**

Location: West Europe

Filter items...

| NAME | TYPE | LOCATION | |
|---|------------------------|--------------------|------------|
|  DCF-AWE-GW01-DCF-AWE-LG01 | Connection | West Europe | ... |
|  DCF-AWE-LG01 | Local network... | West Europe | ... |
|  DCF-AWE-GW01-PIP | Public IP addr... | West Europe | ... |
|  route | Route table | West Europe | ... |
|  DCF-AWE-GW01 | Virtual network... | West Europe | ... |
|  DCF-AWE-VN01 | Virtual network | West Europe | ... |

SETTINGS

- Address
- Connect
- Subnets
- DNS ser
- Peering**
- Properti

DCF-AWE-VN01 - Peerings
Virtual network

+ Add

Search (Ctrl+/)

Overview

Activity log

Access control (IAM)

Search peerings

| NAME | PEERING STATUS |
|-------------|----------------|
| No results. | |

Add peering
DCF-AWE-VN01

Name
DCF-AWE-PR01

Peer details
Virtual network deployment model ⓘ
Resource manager Classic

I know my resource ID ⓘ

Add peering
DCF-AWE-VN01

Name
DCF-AWE-PR01

Peer details
Virtual network deployment model ⓘ
Resource manager Classic

I know my resource ID ⓘ

Resource ID ⓘ
t.Network/virtualNetworks/DCF-AWE-VN ✓

Configuration

Allow virtual network access ⓘ

Enabled Disabled

Allow forwarded traffic ⓘ

Allow gateway transit ⓘ

Use remote gateways ⓘ

DCF-AWE-VN01 - Peerings
Virtual network

+ Add

Search (Ctrl+/)

Overview

Activity log

Search peerings

| NAME | PEERING STATUS | PEER | GATEWAY |
|--------------|----------------|--------------|----------|
| DCF-AWE-PR01 | Initiated | DCF-AWE-VN01 | Disabled |

DCF-AWE-VN01 - Peerings
Virtual network

+ Add

Search (Ctrl+/)

Overview

Activity log

Search peerings

| NAME | PEERING STATUS | PEER | GATEWAY |
|--------------|----------------|--------------|----------|
| DCF-AWE-PR02 | Connected | DCF-AWE-VN01 | Disabled |

DCF-AWE-VN01 - Peerings
Virtual network

+ Add

Search (Ctrl+/)

Overview

Activity log

Search peerings

| NAME | PEERING STATUS | PEER | GATEWAY |
|--------------|----------------|--------------|----------|
| DCF-AWE-PR01 | Connected | DCF-AWE-VN01 | Disabled |

Everything

Filter

Route table

Results

| NAME | PUBLISHER |
|-------------------------|---------------------|
| Route table | Microsoft |
| Cisco ASAv - BYOL 4 NIC | Cisco Systems, Inc. |

Route table

You can add routes to this table after it's...

* Name
DCF-ANE-RT01

* Subscription
Visual Studio Enterprise

* Resource group ⓘ
 Create new Use existing
DCF-ANE-RG01

* Location
North Europe

Pin to dashboard

[Create](#) [Automation options](#)



DCF-ANE-RG01

Resource group



Columns

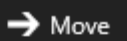
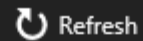
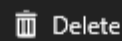

Search (Ctrl+)



Overview



Activity log



Access control (IAM)



Tags

SETTINGS



Quickstart



Resource costs



Deployments



Properties



Locks



Automation script

SUPPORT + TROUBLESHOOTING



New support request

Essentials ^

Subscription name

Visual Studio Enterprise

Last deployment

9/14/2016 (Deploying)

Subscription ID

43b8966b-fc55-463a-83...

Location

North Europe

Filter items...

| NAME | TYPE | LOCATION |
|---------------------------|-------------------|--------------|
| DCF-ANE-GW01-DCF-ANE-LG01 | Connection | North Europe |
| DCF-ANE-GW01-DCF-ANE-LG02 | Connection | North Europe |
| DCF-ANE-EX01 | ExpressRoute... | North Europe |
| DCF-ANE-LG01 | Local network... | North Europe |
| DCF-ANE-LG02 | Local network... | North Europe |
| DCF-ANE-GW01-PIP | Public IP addr... | North Europe |
| DCF-ANE-GW02-PIP | Public IP addr... | North Europe |
| DCF-ANE-GW03-PIP | Public IP addr... | North Europe |
| DCF-ANE-RT01 | Route table | North Europe |

DCF-ANE-RT01
Route table

Delete

Search (Ctrl+F)

Overview

Activity log

Access control (IAM)

Tags

Diagnose and solve problems

SETTINGS

Routes

Subnets

Properties

Locks

Automation script

SUPPORT + TROUBLESHOOTING

New support request

Essentials ^

Resource group
DCF-ANE-RG01

Associations
0 subnet associations

Location
North Europe

Subscription name
Visual Studio Enterprise

Subscription ID
[REDACTED]

Routes

| NAME | ADDRESS PREFIX | NEXT HOP |
|-------------|----------------|----------|
| No results. | | |

Subnets

| NAME | ADDRESS RANGE | VIRTUAL NETWO... | SECURITY GROUP |
|-------------|---------------|------------------|----------------|
| No results. | | | |

The image shows the Azure portal interface for managing subnets. At the top, the 'Subnets' page for resource group 'DCF-ANE-RT01' is visible. A red box highlights the '+ Associate' button. Below this is a search bar and a table with columns: NAME, ADDRESS RANGE, VIRTUAL NETWO..., and SECURITY GROUP. The table currently shows 'No results.' To the right, a partial 'Associate s' dialog is visible with step 1.

Below the main page, two dialog boxes are open:

- Associate subnet** (DCF-ANE-RT01):
 - Step 1: Virtual network DCF-ANE-VN01 (checked with a green checkmark).
 - Step 2: Subnet Choose a subnet (with a right arrow).
- Choose subnet** (DCF-ANE-RT01):
 - Option 1: GatewaySubnet DCF-ANE-RG01 (highlighted with a blue bar).
 - Option 2: Server DCF-ANE-RG01 (highlighted with a red box).

Routes

| NAME | ADDRESS PREFIX | NEXT HOP |
|-------------|----------------|----------|
| No results. | | |

Subnets

| NAME | ADDRESS RANGE | VIRTUAL NETWO... | SECURITY GROUP |
|--------|---------------|------------------|----------------|
| Server | 16.0.1.0/24 | DCF-ANE-VN01 | - |

Routes DCF-ANE-RT01

+ Add

Search routes

| NAME | ADDRESS PREFIX | NEXT HOP |
|-------------|----------------|----------|
| No results. | | |

Add route DCF-ANE-RT01

- * Route name: Route01
- * Address prefix: 192.168.20.0
- Next hop type: Virtual applia
- * Next hop address: 16.0.1.100



Ensure you... your virtu... by navig... interface

Everything

Filter

Barracuda NextGen Firewall F-Series (BYOL)

Results

| NAME | PUBLISHER |
|--|--------------------------|
|  Barracuda NextGen Firewall F-Series (BYOL) | Barracuda Networks, Inc. |
|  Barracuda NextGen Control Center (BYOL) | Barracuda Networks, Inc. |

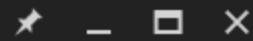

Bring Your Own License enabled.

The Barracuda NextGen Firewall F-Series fills the functional gaps between cloud infrastructure security and a defense-in-depth strategy by providing protection where the application and data reside, rather than solely where the connection terminates. Because of the isolation between VMs, tenants, and virtual networks, the Barracuda NextGen Firewall F-Series operates just as if it were a physical device bridging connections between application servers in a network DMZ and your ISP's router.

Beyond its powerful network firewall, high availability, and VPN technologies, the Barracuda NextGen Firewall F-Series integrates a comprehensive set of next-generation firewall technologies, including Application Control, IPS, anti-malware, network access control enforcement, and comprehensive user awareness. The F-Series is fully compatible with Microsoft Azure for establishing site-to-site and/or client-to-site connections to its cloud services, and creating a virtual DMZ in Azure to implement an additional high-security layer.

The Barracuda NextGen Firewall F-Series meets enterprise requirements of massive scalability, efficient configuration and lifecycle management across dispersed networks, and performance guarantees for business-critical applications.

The Barracuda NextGen Firewall F-Series is a powerful, user-friendly appliance to protect and manage your network. As a Linux-based security appliance, there are few differences between it and a typical server running on Azure:

- Administration of the Barracuda NextGen Firewall F-Series appliance is typically done with a Windows-based client application called as [Barracuda NG Admin](#).
- This Barracuda NextGen Firewall F-Series is licensed using the Bring-Your-Own-License (BYOL) model. [Fill out the evaluation form](#) to receive a 30-day evaluation license or purchase one of the licenses depending on your requirement.

Note: The username to login to the appliance is **root** and the password is the one you have configured on Azure portal while deploying the VM. Also a forward for TCP/807 and TCP-UDP/691 endpoints will be created automatically when you deploy this VM. Click [here](#) for more details.

Create virtual machine

- 1 Basics
Configure basic settings
- 2 Size
Choose virtual machine size
- 3 Settings
Configure optional features
- 4 Summary
Barracuda NextGen Firewall F-S...
- 5 Buy

Basics

* Name
DCF-AWE-FW01 ✓

VM disk type ⓘ
HDD ▼

* User name
[REDACTED] ✓

* Authentication type
SSH public key Password

* Password
[REDACTED] ✓

* Confirm password
[REDACTED] ✓

Subscription
Visual Studio Premium with MSDN ▼

* Resource group ⓘ
 Create new Use existing

DCF-AWE-RG01 ▼

Location
West Europe ▼

Create virtual machine

Choose a size

Browse the available sizes and their features

1 Basics ✓
Done

2 Size >
Choose virtual machine size

3 Settings >
Configure optional features

4 Summary >
Barracuda NextGen Firewall F-S...

5 Buy >

A1 Standard ★

A2 Standard ★

1 Core

2 Cores

1.75 GB

3.5 GB

 **2**
Data disks

 **4**
Data disks

 **2x500**
Max IOPS

 **4x500**
Max IOPS

 **Load balancing**

 **Load balancing**

Loading pricing...

Loading pricing...

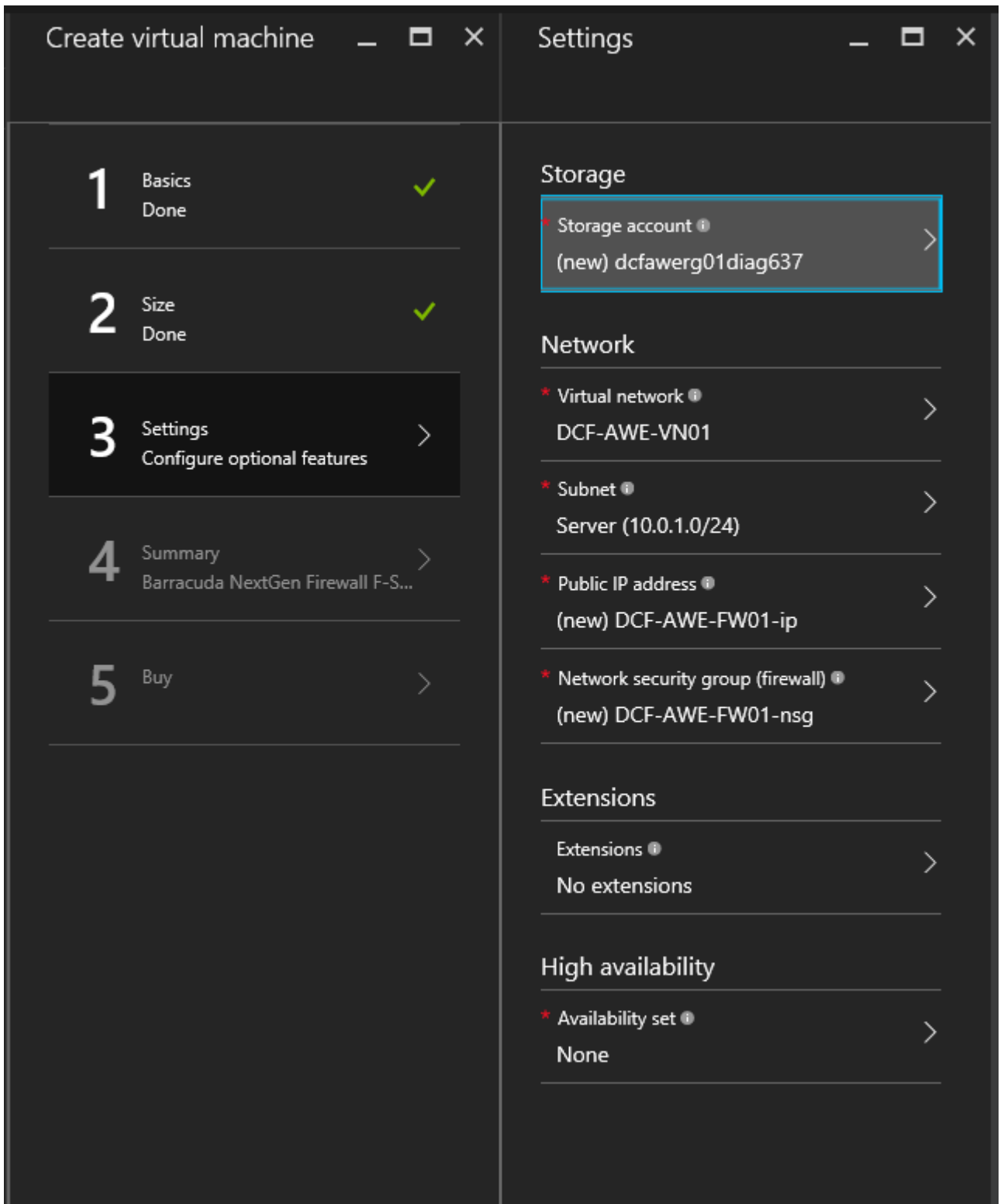

Create virtual machine Summary

1 Basics Done ✓

2 Size Done ✓

3 Settings Done ✓

4 Summary Barracuda NextGen Firewall F-S... >

5 Buy >

i Validation passed

Basics

| | |
|----------------|---------------------------------|
| Subscription | Visual Studio Premium with MSDN |
| Resource group | DCF-AWE-RG01 |
| Location | West Europe |

Settings

| | |
|-----------------------------------|-------------------------|
| Computer name | DCF-AWE-FW01 |
| Disk type | HDD |
| User name | ██████████ |
| Size | Standard A1 |
| Storage account | (new) dcfawerg01diag637 |
| Virtual network | DCF-AWE-VN01 |
| Subnet | Server (10.0.1.0/24) |
| Public IP address | (new) DCF-AWE-FW01-ip |
| Network security group (firewall) | (new) DCF-AWE-FW01-nsg |
| Availability set | None |

1 Basics Done ✓

2 Size Done ✓

3 Settings Done ✓

4 Summary Barracuda NextGen Firewall F-S... ✓

5 Buy >

Offer details

Barracuda NextGen Firewall F-Series 0,000
by Barracuda Networks, Inc.

[Terms of use](#) | [privacy policy](#)

Standard A1 0,050
by Microsoft [Pricing](#)

[Terms of use](#) | [privacy policy](#)

⚠ The highlighted Marketplace purchase(s) are not covered by your subscription and will be billed separately.

You cannot use your Azure monetary commitment funds or subscription benefits for Marketplace purchases. You will be billed separately for marketplace purchases.

i Azure resource

You may use your Azure monetary commitment funds or subscription benefits for Marketplace purchases. Prices presented are retail prices and may not reflect your subscription. See [Pricing](#) for details.

Terms of use

By clicking "Purchase", I (a) agree to the legal terms and privacy statement for the Marketplace offering above, (b) authorize Microsoft to charge or bill me for the fees associated with my use of the offering(s), including applicable taxes, on a monthly frequency as my Azure subscription, until I discontinue use of the offering(s). Microsoft may share my contact information and transaction details with third-party providers (s). Microsoft does not provide rights for third-party products or services. See [Terms](#) for additional terms.

Purchase











+ Add Columns Delete Refresh Move

Essentials ^

Subscription name
Visual Studio Premium with MSDN
Last deployment
9/17/2016 (Succeeded)

Subscription ID
4a8ad611-6c01-4f99-ba5e-2cad700afc54
Location
West Europe

Filter items...

| NAME | TYPE | LOCATION | |
|---|-------------------|-------------|-----|
|  DCF-AWE-FW01 | Virtual machine | West Europe | ... |
|  DCF-AWE-GW01-DCF-AWE-LG01 | Connection | West Europe | ... |
|  DCF-AWE-LG01 | Local network... | West Europe | ... |
|  dcf-awe-fw01206 | Network inter... | West Europe | ... |
|  DCF-AWE-FW01-nsg | Network secu... | West Europe | ... |
|  DCF-AWE-FW01-ip | Public IP adr... | West Europe | ... |
|  DCF-AWE-GW01-PIP | Public IP adr... | West Europe | ... |
|  route | Route table | West Europe | ... |
|  DCF-AWE-GW01 | Virtual networ... | West Europe | ... |
|  DCF-AWE-VN01 | Virtual network | West Europe | ... |
|  dcfawerg01diag637 | Storage accou... | West Europe | ... |

Search (C

- Overview
- Activity l
- Access co
- Tags
- Diagnose

SETTINGS

- Availabili
- Disks
- Extension

Network

- Size
- Propertie
- Locks
- Automati

MONITORING

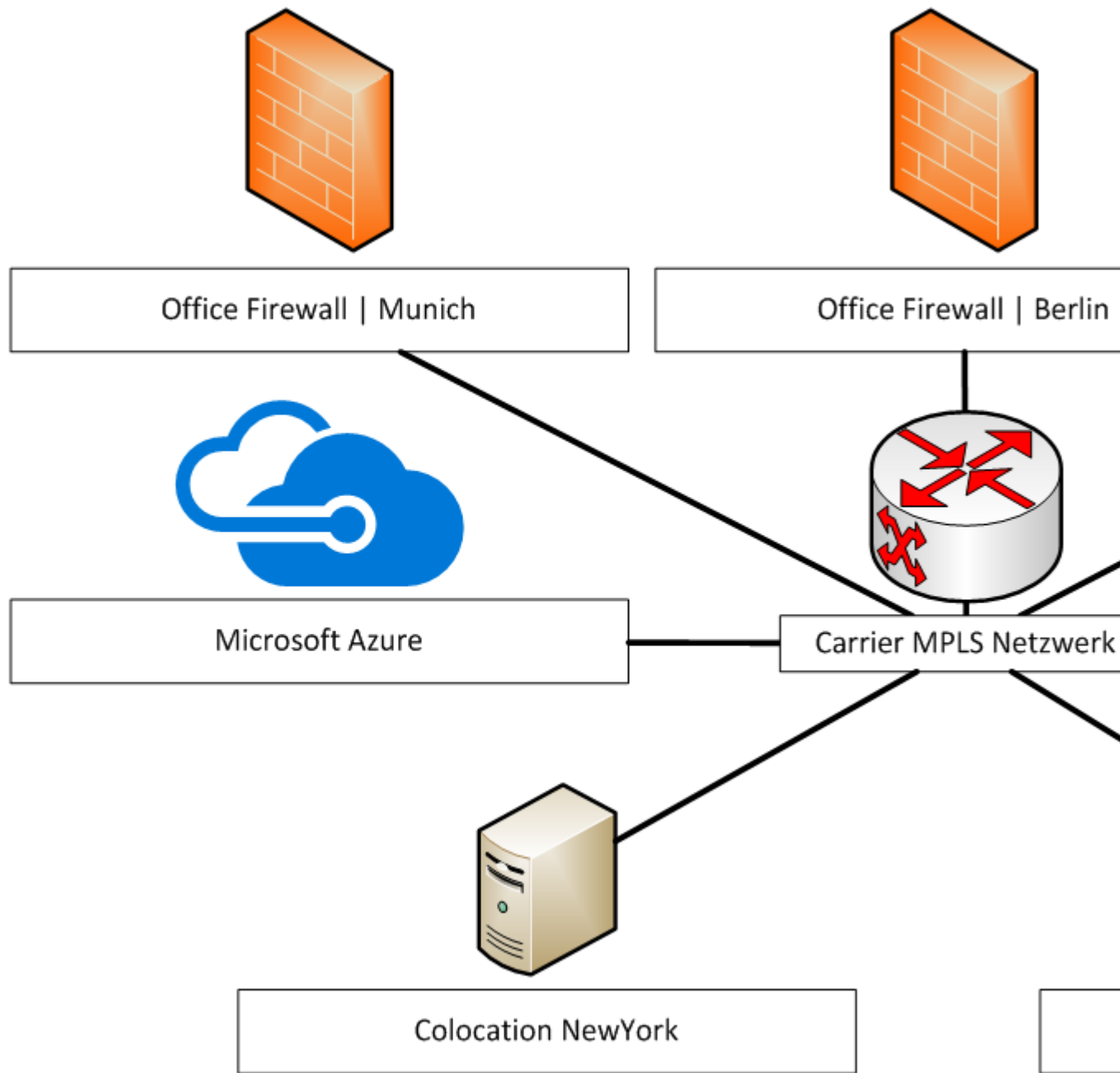

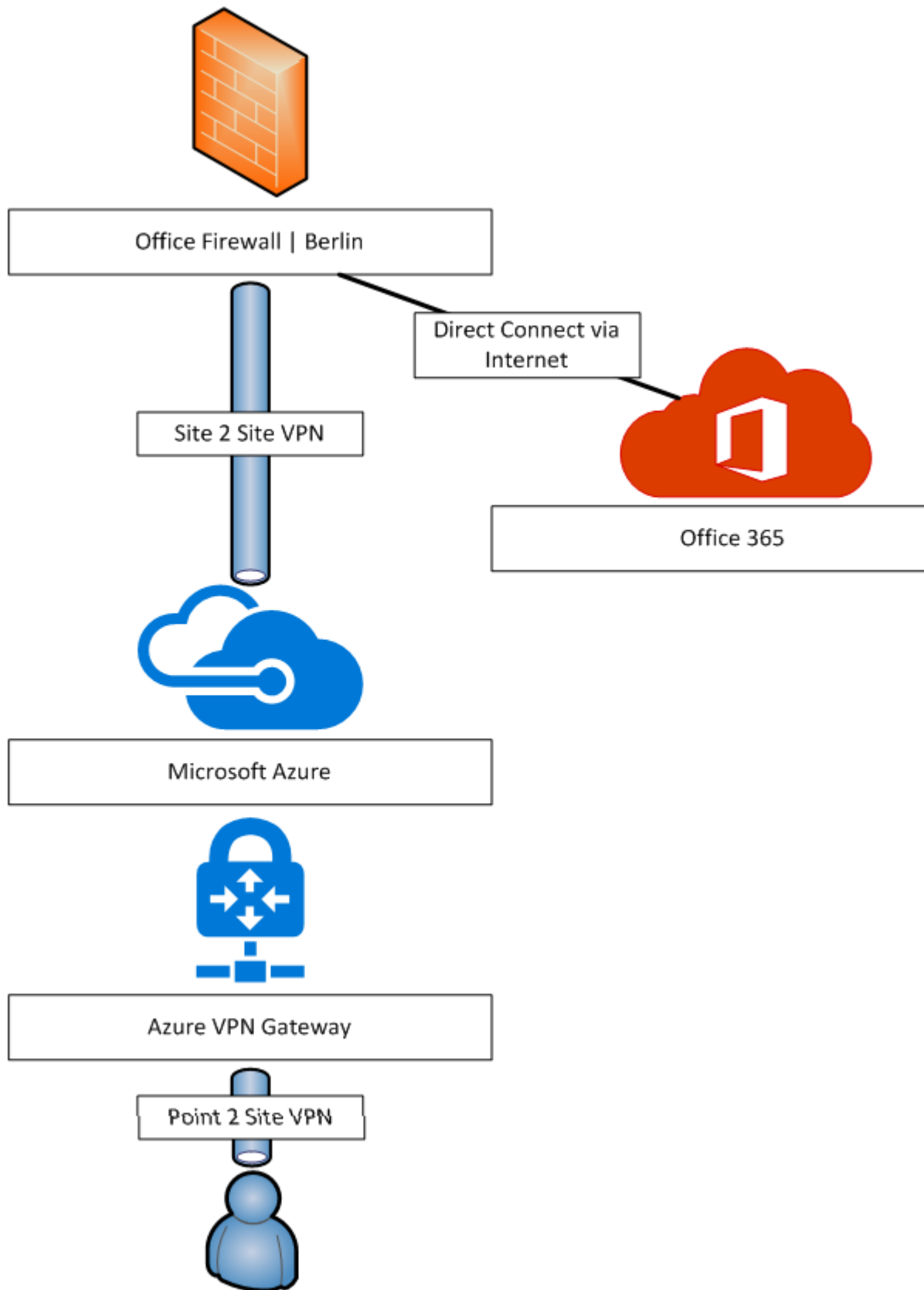



Microsoft Azure

Site 2 Site VPN



Carrier MPLS N

Site 2 Site VPN



Chapter 5: Implementing and Securing Azure Storage Accounts



Create storage account

The cost of your storage account depends on the usage and the options you choose below.

[Learn more](#)

* Name ⓘ

core.windows.net

Deployment model ⓘ

Resource manager Classic

Account kind ⓘ

General purpose ▼

Performance ⓘ

Standard Premium

Replication ⓘ

Read-access geo-redundant storage (RA... ▼

* Storage service encryption ⓘ

Disabled Enabled

* Subscription

Visual Studio Enterprise mit MSDN ▼

* Resource group ⓘ

Create new Use existing

* Location

West Europe ▼

Create storage account – □ ×

The cost of your storage account depends on the usage and the options you choose below.

[Learn more](#)

* Name ⓘ

implementingazuredemo ✓
core.windows.net

Deployment model ⓘ

Resource manager Classic

Account kind ⓘ

General purpose ▼

Performance ⓘ

Standard Premium

Replication ⓘ

Locally-redundant storage (LRS) ▼

* Storage service encryption ⓘ

Disabled Enabled

* Subscription

Visual Studio Enterprise ▼

* Resource group ⓘ

Create new Use existing

AzureExamples ▼

* Location

North Europe ▼

Pin to dashboard

Create

[Automation options](#)



- Overview
 - Activity log
 - Access control (IAM)
 - Tags
 - Diagnose and solve problems
- SETTINGS
- Access keys
 - Configuration
 - Shared access signature

Essentials ^

Resource group [\(change\)](#)
azureexamples

Status
Primary: Available

Location
North Europe

Subscription name [\(change\)](#)
Visual Studio Enterprise

Subscription ID
159fbd1c-ab70-4eac-93f1-55d9b387a342

Performance
Standard
Replication
Locally-redundant storage

Services

Blobs

Files

Table

Monitoring

Blob service

implementingazuredemo



Container



Refresh

Essentials v

NAME

URL

LAST MODIFIED

No containers found.

New container

Blob service (implementingazuredemo)

* Name

testcontainer ✓

Access type ⓘ

Private ▾

Create

Blob service

implementingazuredemo

+ Container Refresh

Essentials ▾

🔍 Search containers by prefix

| NAME | URL | LAST MODIFIED |
|---------------|---|-----------------------|
| testcontainer | https://implementingazuredemo.blob.core.wi... | 1/12/2017, 5:02:47 AM |

testcontainer

Container

📁 Upload Refresh 🗑 Delete container ☰ Properties 🗝 Access policy

Location: testcontainer

🔍 Search blobs by prefix (case-sensitive)

| NAME | MODIFIED | BLOB T |
|-----------------|----------|--------|
| No blobs found. | | |



implementingazuredemo

Storage account



Open in Explorer



Delete



Search (Ctrl+*/*)



Overview



Activity log



Access control (IAM)



Tags



Diagnose and solve problems

SETTINGS



Access keys



Configuration



Shared access signature

Essentials [^]

Resource group ([change](#))

[azureexamples](#)

Status

Primary: Available

Location

North Europe

Subscription name ([change](#))

[Visual Studio Enterprise](#)

Subscription ID

159fbd1c-ab70-4eac-93f1-55d9b387a342

Performance

Standard

Replication

Locally-redundant storage

Services



Blobs



Files



Tabl

Monitoring

Table service

implementingazuredemo



Refresh

Essentials [^]



Search tables by prefix

TABLE

URL

No tables found.

Table service

implementingazuredemo

 Refresh

Essentials 

 Search tables by prefix

| TABLE | URL |
|-----------|--|
| testtable | https://implementingazuredemo.table.core.windows.net |

implementingazuredemo

Storage account

 Open in Explorer

 Delete

 Search (Ctrl+/)

 Overview

 Activity log

 Access control (IAM)

 Tags

 Diagnose and solve problems

SETTINGS

 Access keys

 Configuration

 Shared access signature

Essentials 

Resource group [\(change\)](#)

azureexamples

Status

Primary: Available

Location

North Europe

Subscription name [\(change\)](#)

Visual Studio Enterprise

Subscription ID

159fbd1c-ab70-4eac-93f1-55d9b387a342

Performance

Standard

Replication

Locally-redundant storage

Services

 Blobs

 Files

 Table

Queue service

implementingazuredemo

 Refresh

Essentials 

 Search queues by prefix (case-sensitive)

QUEUE

URL

No queues found.

Queue service

implementingazuredemo

 Refresh

Essentials 

 Search queues by prefix (case-sensitive)

QUEUE

URL

testqueue

<https://implementingazuredemo.queue.core.windows.net>

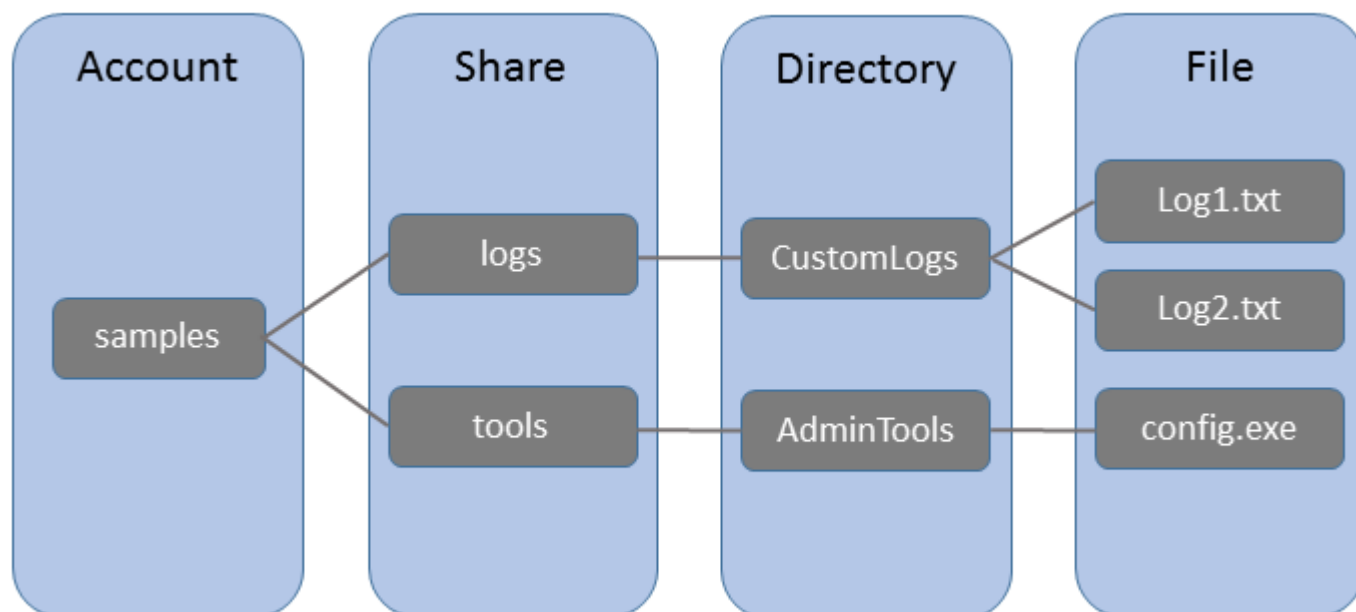



implementingazuredemo

Storage account



Open in Explorer



Delete



Search (Ctrl+/)



Overview



Activity log



Access control (IAM)



Tags



Diagnose and solve problems

SETTINGS



Access keys



Configuration



Shared access signature

Essentials ^

Resource group [\(change\)](#)

azureexamples

Status

Primary: Available

Location

North Europe

Subscription name [\(change\)](#)

Visual Studio Enterprise

Subscription ID

159fbd1c-ab70-4eac-93f1-55d9b387a342

Performance

Standard

Replication

Locally-redundant storage

Services



Blobs



Files



Table

Monitoring

File service

implementingazuredemo



File share



Refresh

Essentials v



Search file shares by prefix

NAME

MODIFIED

QUO

No file shares found.

New file share

File service (implementingazuredemo)

* Name

testshare ✓

Quota ⓘ

GB

File service

implementingazuredemo

[+ File share](#) [↻ Refresh](#)

Essentials ▾

| NAME | MODIFIED | QUOTA |
|-----------|-----------------------|-------|
| testshare | 1/15/2017, 6:09:04 PM | 5 TB |

testshare

File share

[↶ Connect](#) [↶ Upload](#) [+ Add directory](#) [↻ Refresh](#) [🗑 Delete share](#) [☰ Properties](#) [✎ Quota](#)

Location: [testshare](#)

| NAME | TYPE | SIZE |
|-----------------|------|------|
| No files found. | | |

New directory

testshare

* Name

testshare
File share

[Connect](#) [Upload](#) [Add directory](#) [Refresh](#) [Delete share](#) [Properties](#) [Quota](#)

Location: [testshare](#)

| NAME | TYPE | SIZE |
|---|-----------|------|
|  testdir | Directory | |

Connect

testshare



Connecting from Windows

To connect to this file share from a Windows computer, run this command:

```
> net use [drive letter] \\implementingazuredemo.file.core.windows.net
/testshare /u:implementingazuredemo [storage account access key]
```

When connecting from a computer from outside Azure, remember to open outbound TCP port 445 in your local network. Some Internet service providers may block port 445. Check with your service provider for details.

[Learn more about Azure File Storage with Windows](#)

Connecting from Linux

To connect to this file share from a Linux computer, run this command:

```
> sudo mount -t cifs //implementingazuredemo.file.core.windows.net
/testshare [mount point] -o
vers=3.0,username=implementingazuredemo,password=[storage account access
key],dir_mode=0777,file_mode=0777
```

The Linux SMB3 client doesn't support share level encryption yet, so mounting a file share in Linux only works from virtual machines running in the same Azure region as the file share.

[Learn more about Azure File Storage with Linux](#)

[View access keys for this storage account](#)

```
Administrator: Windows PowerShell
PS C:\Users\AzureDemo> net use Y: \\implementingazuredemo.file.core.windows.net\testshare /u:imple
LfIJNETVBNfwecvGNC6FMp4rwyiKa8qcHdVRdg53MxZ1Vlr8tUrAaJNo6jNqF0BgqzN1DaacYXrZjbxxA==
The command completed successfully.
PS C:\Users\AzureDemo> _
```

Network locations (1)

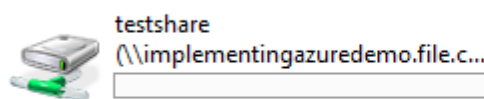

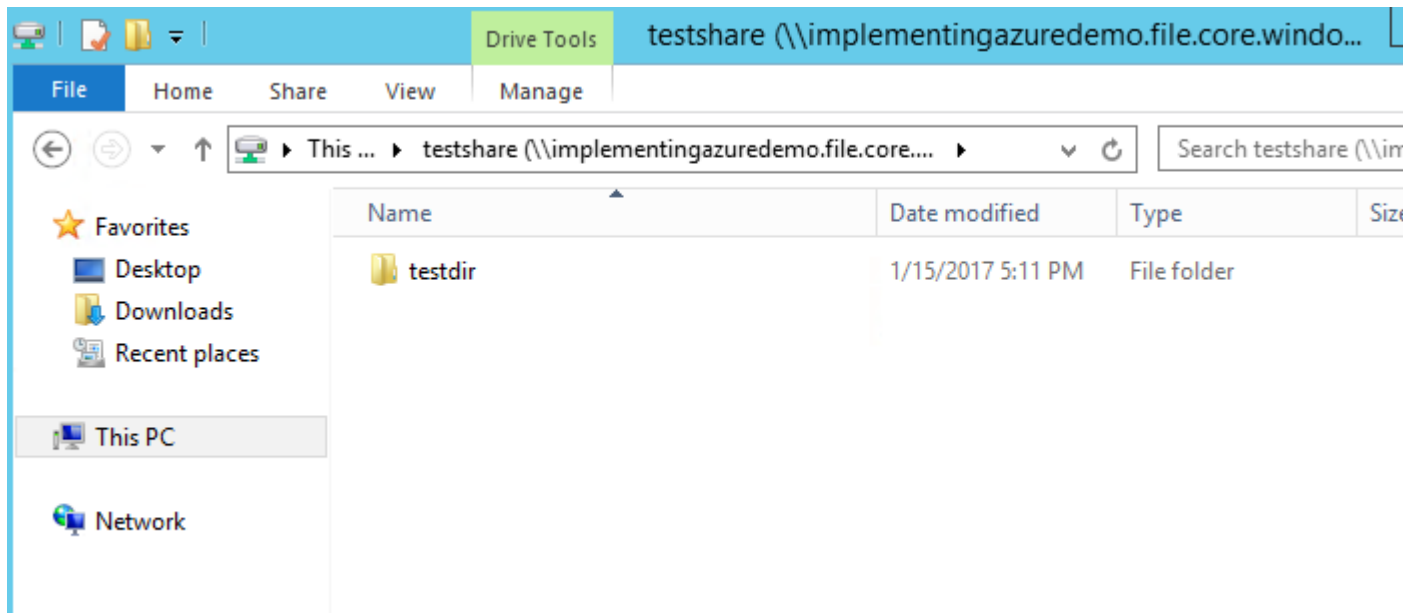

implementingazuredemo - Access keys

Storage account

Search (Ctrl+/)

- Overview
- Activity log
- Access control (IAM)
- Tags
- Diagnose and solve problems

SETTINGS

- Access keys**
- Configuration
- Shared access signature
- Properties

Use access keys to authenticate your applications when making requests to the storage account. Store your access keys securely - for example, using Azure Key Vault. We recommend regenerating your access keys regularly. You are provided two keys; you can maintain connections using one key while regenerating the other.

When you regenerate your access keys, you must update any Azure resources that access this storage account to use the new keys. This action will not interrupt your virtual machines. [Learn more](#)

Storage account name:

| NAME | KEY |
|------|---|
| key1 | 3tgZqLfIJNETVBNfwecvGNC6FMp4rwyiKa8qcHdVRdg53Mx |
| key2 | aiKefLrA1uCqdMF0GKNjaHbmqhLR7cA50w5WBWYaKTO4 |



implementingazuredemo - Access keys

Storage account

Overview

Activity log

Access control (IAM)

Tags

Diagnose and solve problems

SETTINGS

Access keys

Configuration

Shared access signature

Properties

Use access keys to authenticate your applications when making requests to the storage account. Store your access keys securely - for example, using Azure Key Vault. We recommend regenerating your access keys regularly. You are provided two keys; you can maintain connections using one key while regenerating the other.

When you regenerate your access keys, you must update any Azure resources that access this storage account to use the new keys. This action will not interrupt your virtual machines. [Learn more](#)

Storage account name

| NAME | KEY |
|------|---|
| key1 | 3tgZqLfJUNETVBNfwecvGNC6FMp4rwyiKa8qcHdVRdg53Mx |
| key2 | aiKefLrA1uCqdMF0GKNjaHbmqhLR7cA50w5WBWYaKTO4 |

Edit Help

 Microsoft Azure



Show resources from these subscriptions:

[Add an account...](#)

Apply

Cancel



Activities

What do you like about this tool?

What don't you like or feel is missing?

 Microsoft Azure Storage Explorer

Edit Help

 Microsoft Azure

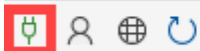

Search for resources 

[Collapse All](#)

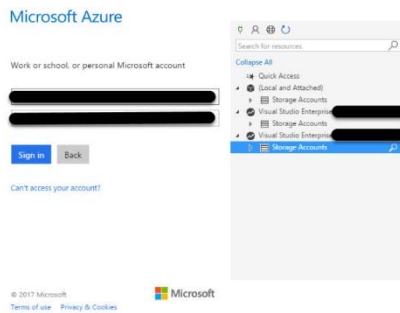
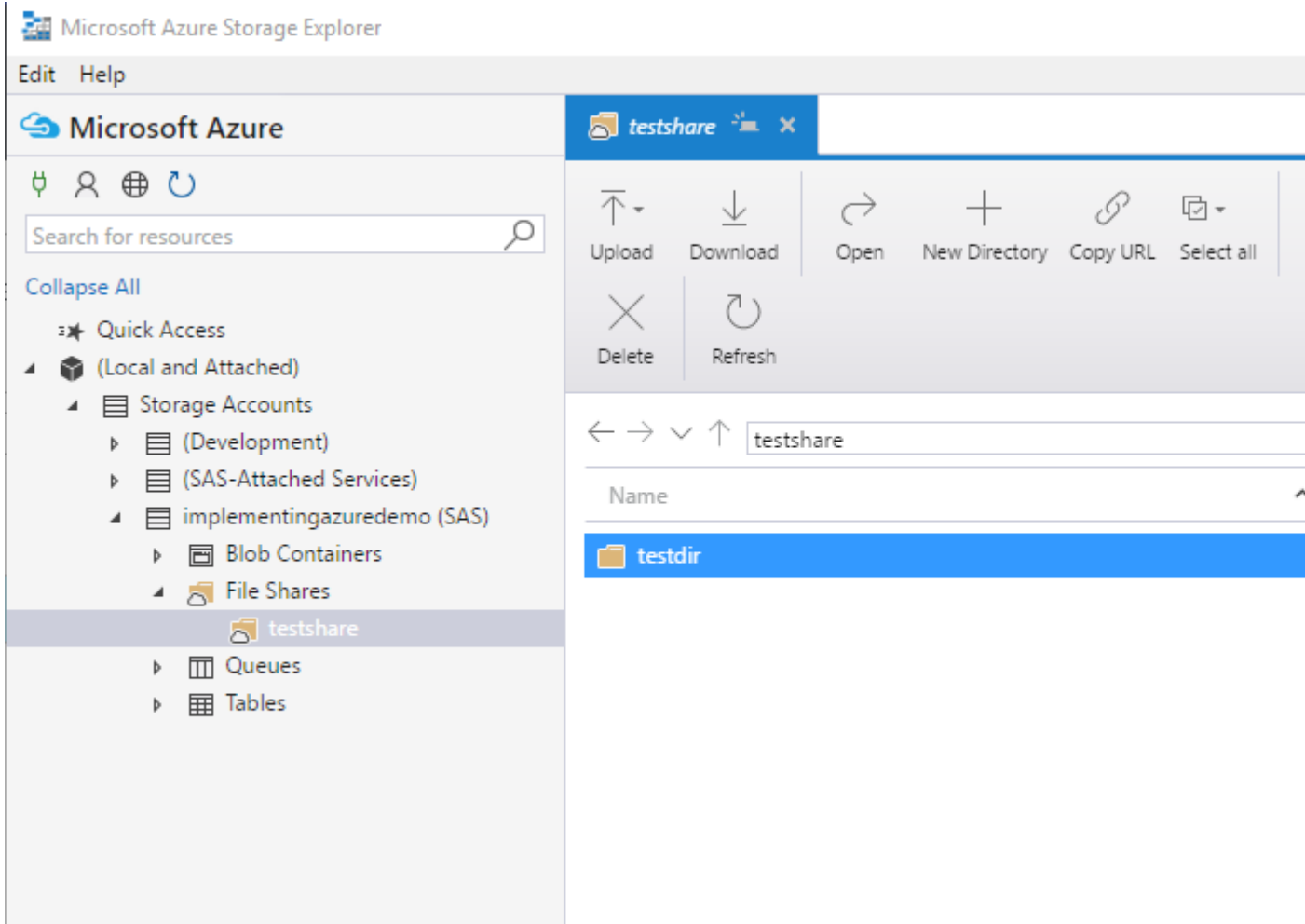

Chapter 6: Planning and Deploying Virtual Machines in Azure

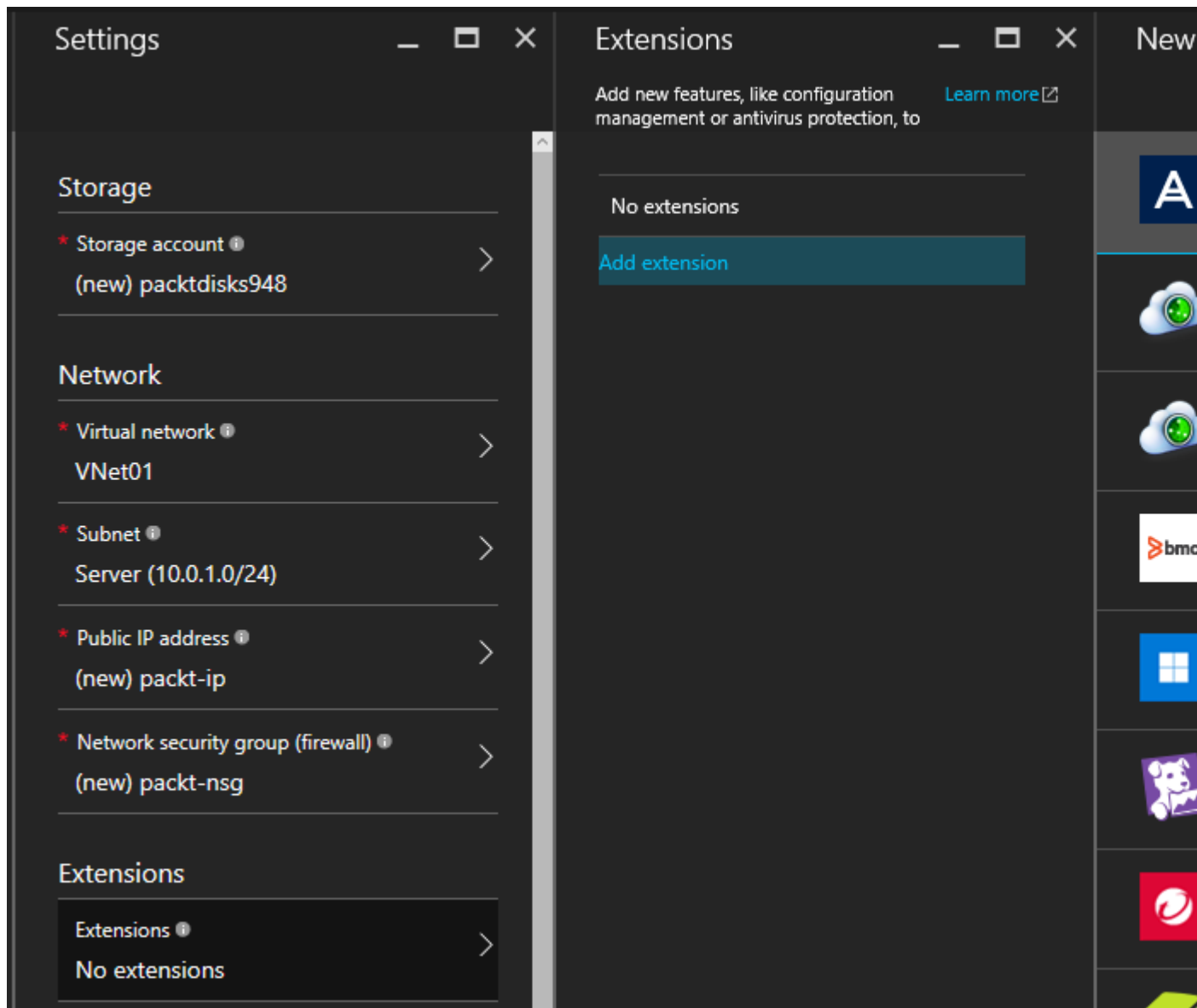

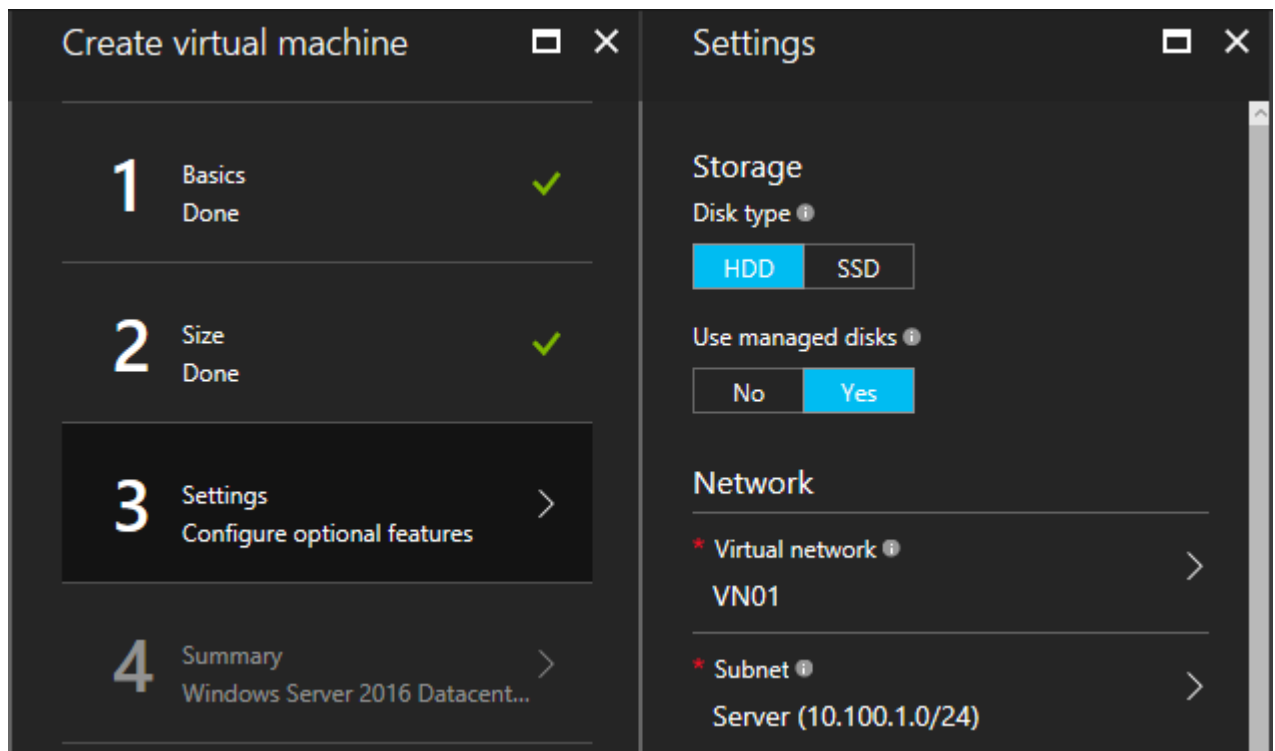



CHE-VM1 - Disks

Virtual machine

Search (Ctrl+/)

- Overview
- Activity log
- Access control (IAM)
- Tags
- Diagnose and solve problems

SETTINGS

- Availability set
- Disks**
- Extensions
- Network interfaces
- Size
- Backup
- Properties

Edit

2

OS disk

NAME

CHE-VM1

Data disks

None

1



Fault Domain 01

Update Domain 01

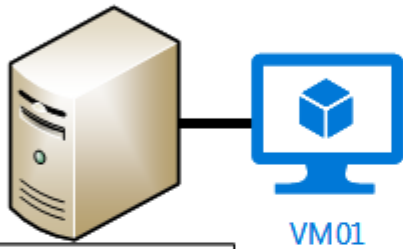

Physical Host

Update Domain 02



Physical Host



Fault Domain 02

Update Domain 01





Physical Host

Update Domain 02

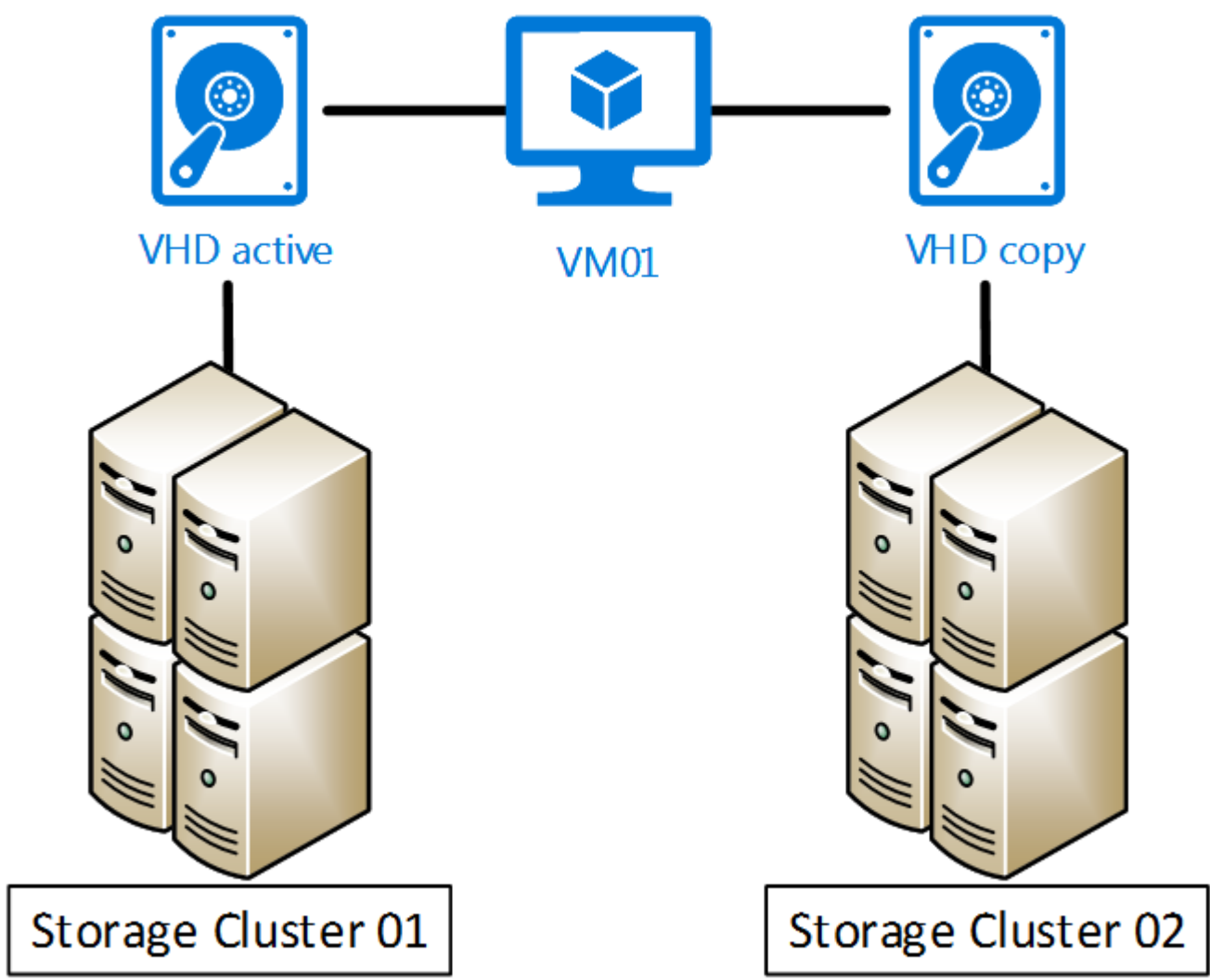

Physical Host



 Search (Ctrl+/)

 Overview

 Activity log

 Access control (IAM)

 Tags

SETTINGS

 Quickstart

 Resource packs

Essentials ^



Subscription name
Visual Studio Premium with MSDN

Last deployment
No deployments

Subscription ID
 4a8ad611-6c01-4f99-ba

Location
Brazil South

Filter items...

| NAME | TYPE | LOCAT |
|--|------------------|--------|
|  VNet01 | Virtual network | Brazil |
|  packtsrg | Storage accou... | Brazil |

☰

Shift+Space to toggle favorites

+

Filter

By category ▾

- Billing PREVIEW ★
- Subscriptions ★
- Help + support ★

COMPUTE

- Virtual machines ★
- Virtual machines (classic) ★
- Virtual machine scale sets ☆
- Container services ☆
- Batch accounts ☆
- Service Fabric clusters ☆
- Cloud services (classic) ★
- RemoteApp collections ☆
- Availability sets ☆
- OS disks (classic) ☆
- VM images (classic) ☆

>



Virtual machines

DataCenter-Flo



+ Add

Columns

Refresh



Subscriptions: All 2 selected – Don't see a subscription? [Switch directories](#)

Filter items...

All subscriptions



NAME



No Virtual machines to display



Virtual Machines

Filter

Search Virtual Machines

Create

Recommended



Windows Server

Microsoft

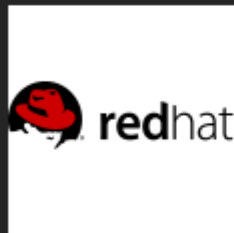

Red Hat Enterprise Linux

RedHat



Ubuntu Server

Canonical

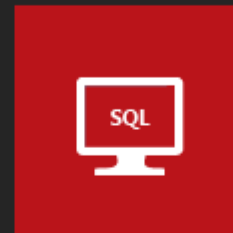

SQL Server 2016 RTM Enterprise on

Microsoft



Virtual machine scale set

Microsoft

Virtual Machine Images

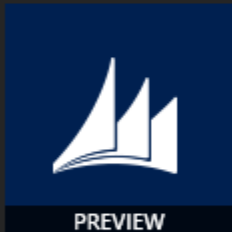

Dynamics AX 2012 R3 (preview)

Microsoft



Drupal

Bitnami

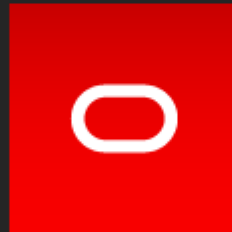

Oracle Linux 7.0.0.1

Oracle



concrete5

Bitnami



ReportServer Community

Bitnami

What's new



Cello Virtual Warehouse

Samsung SDS



HPE ArcSight ESM

Hewlett Packard Ent...



Cristie CloneManager

Cristie Software Ltd



ADAM Sandbox

ADAM Software



Keyhub

iQuest

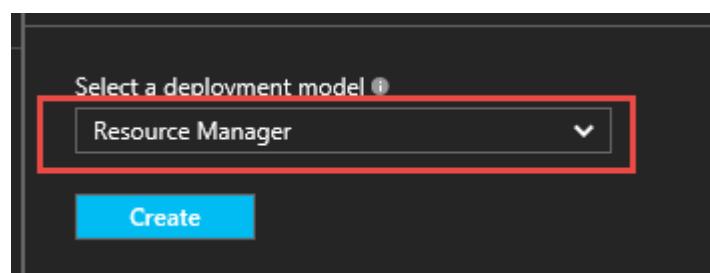
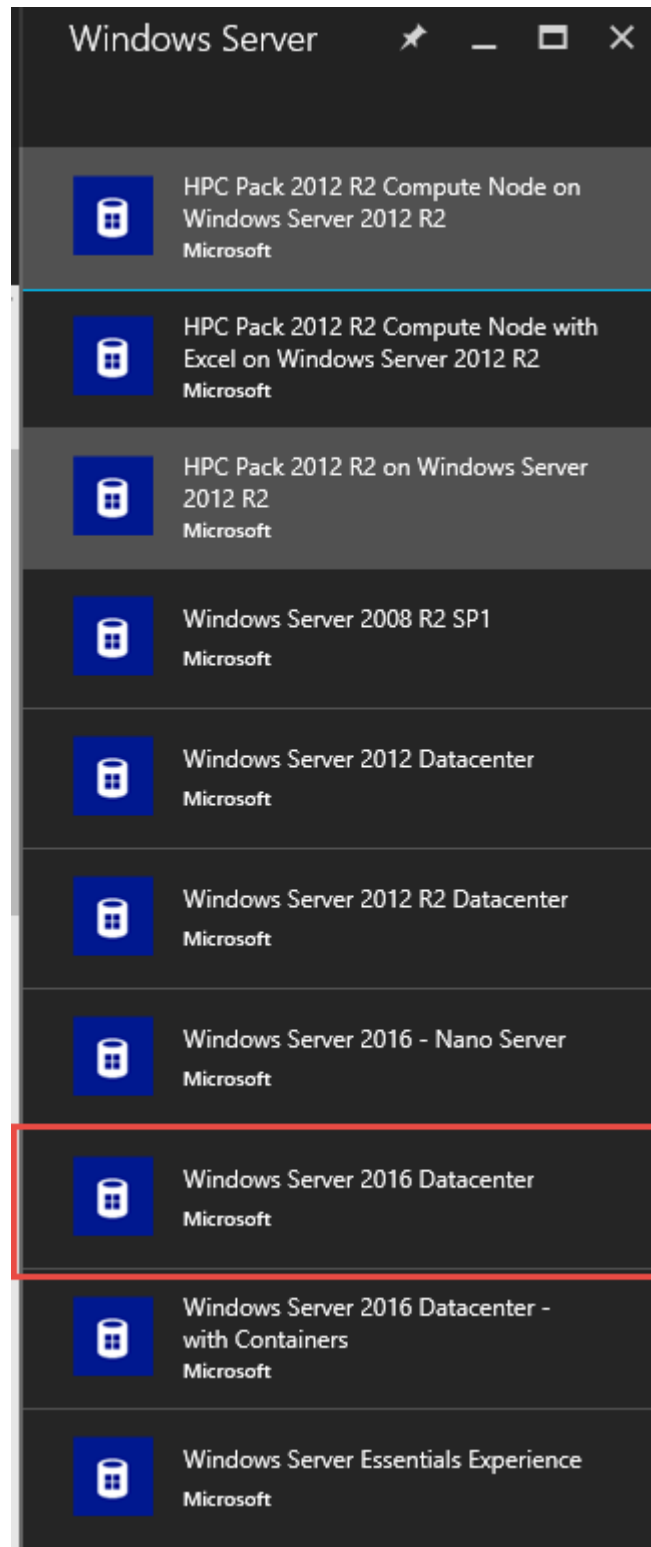

Create virtual machine

- 1 Basics
Configure basic settings
- 2 Size
Choose virtual machine size
- 3 Settings
Configure optional features
- 4 Summary
Windows Server 2016 Datacent...

Basics

* Name ✓

VM disk type ▼

* User name ✓

* Password ✓

* Confirm password ✓

Subscription ▼

* Resource group Create new Use existing

▼

Location ▼

Save money

Save up to 40% with a license you already own.

* Already have a Windows Server license?

Yes No

* I confirm I have an eligible Windows Server license with Software Assurance to apply this Hybrid Use Benefit.

[Learn more](#)

Create virtual machine



1 Basics
Done

2 Size
Choose virtual machine size >

3 Settings
Configure optional features >

4 Summary
Windows Server 2016 Datacent... >

Choose a size

Browse the available sizes and their features

Prices presented are estimates in your local currency that include on any discounts for the subscription and location. The prices don't include Recommended sizes are determined by the publisher of the selected software requirements.

Supported disk type

HDD

Minimum memory (GiB)

0

| DS1_V2 Standard | | DS2_V2 Standard | |
|---------------------------------------|------|---------------------------------------|-------|
| 1 | Core | 2 | Cores |
| 3.5 | GB | 7 | GB |
| 2 Data disks | | 4 Data disks | |
| 3200 Max IOPS | | 6400 Max IOPS | |
| 7 GB Local SSD | | 14 GB Local SSD | |
| Load balancing | | Load balancing | |
| Premium disk support | | Premium disk support | |
| 42,66 EUR/MONTH (ESTIMATED) | | 85,33 EUR/MONTH (ESTIMATED) | |

Create virtual machine



1 Basics ✓
Done

2 Size >
Choose virtual machine size

3 Settings >
Configure optional features

4 Summary >
Windows Server 2016 Datacent...

Choose a size

Browse the available sizes and their features

Prices presented are estimates in your local currency that include on any discounts for the subscription and location. The prices don't include costs. Recommended sizes are determined by the publisher of the s and software requirements.

Supported disk type

SSD ▼

Minimum memory (GiB)

| DS1_V2 Standard ★ | DS2_V2 Standard ★ |
|--------------------------------|--------------------------------|
| 1 Core | 2 Cores |
| 3.5 GB | 7 GB |
| 2 Data disks | 4 Data disks |
| 3200 Max IOPS | 6400 Max IOPS |
| 7 GB Local SSD | 14 GB Local SSD |
| Load balancing | Load balancing |
| Premium disk support | Premium disk support |
| 42,66 EUR/MONTH (ESTIMATED) | 85,33 EUR/MONTH (ESTIMATED) |
| DS4_V2 Standard | DS5_V2 Standard |
| 8 Cores | 16 Cores |
| 28 GB | 56 GB |
| 16 Data disks | 32 Data disks |
| 25600 Max IOPS | 51200 Max IOPS |
| 56 GB Local SSD | 112 GB Local SSD |
| Load balancing | Load balancing |
| Premium disk support | Premium disk support |

Select

| | | |
|---------------------|----------------------|---------------|
| Supported disk type | Minimum memory (GiB) | Minimum cores |
| HDD | 0 | 1 |

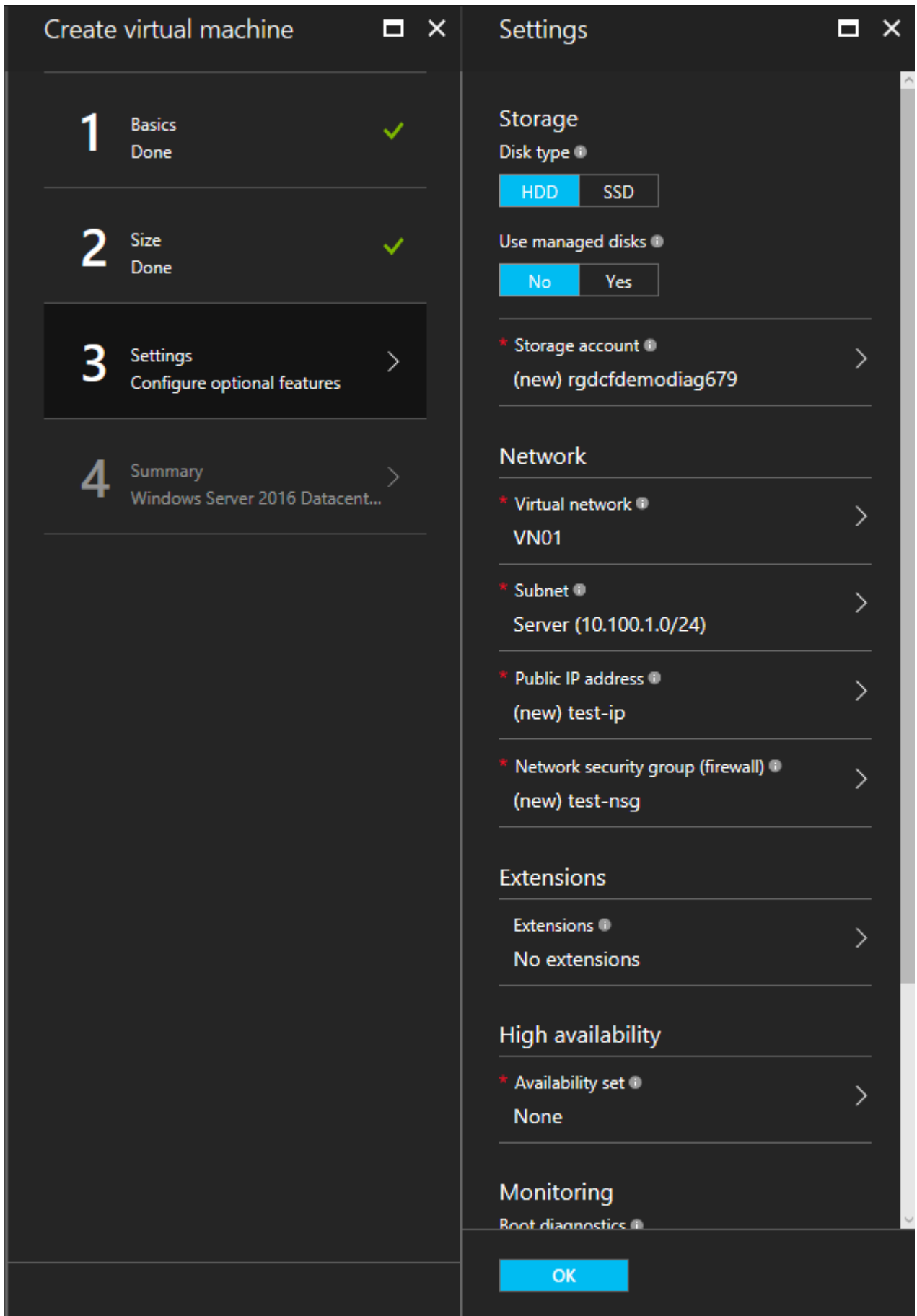

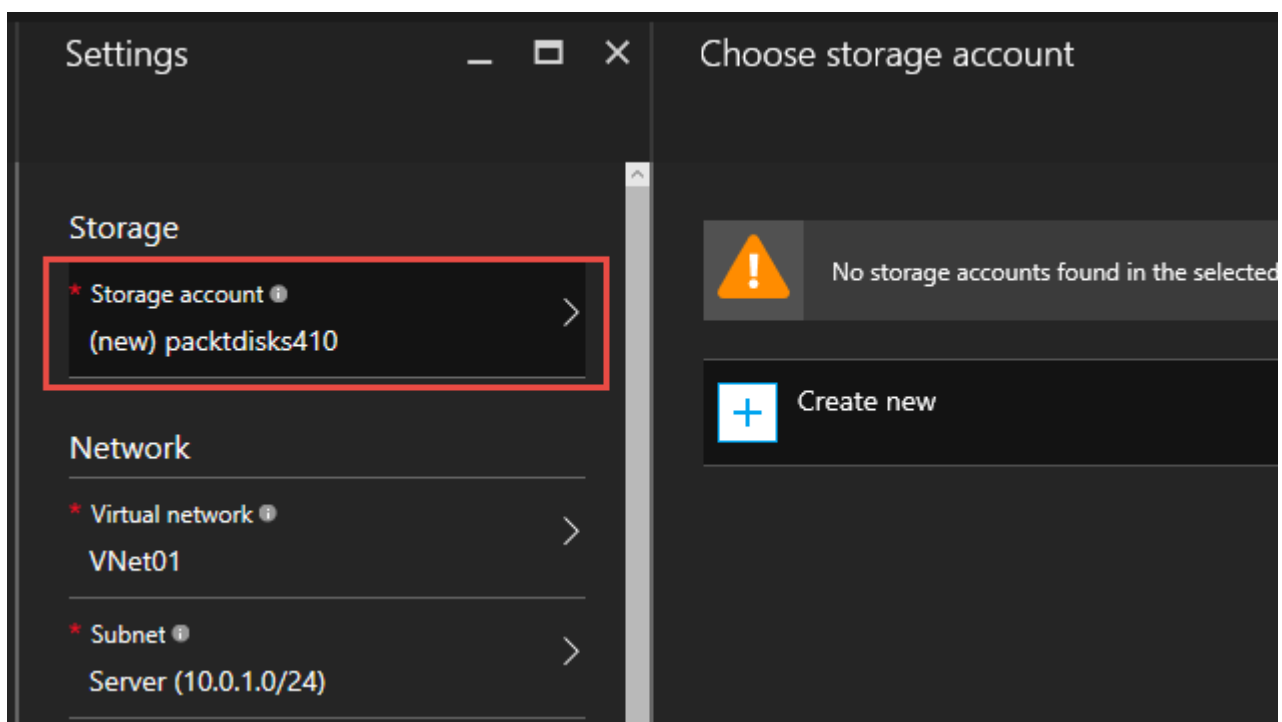
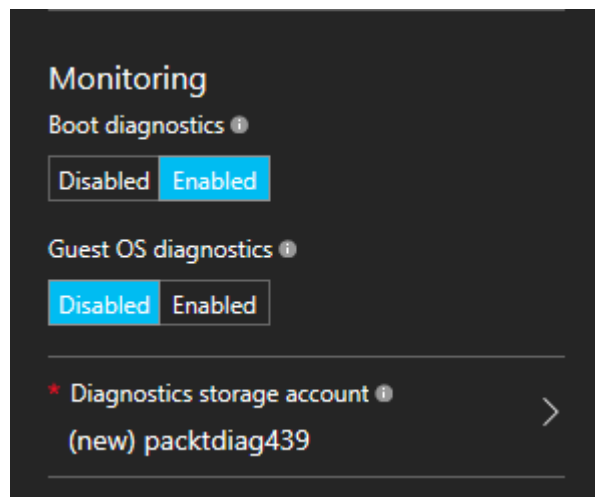

Choose storage account

No storage accounts found in the selected subscription and location 'Brazil South'.

[+](#) Create new

Create storage account

* Name
packtdisks410

Performance ⓘ
Standard Premium

Replication ⓘ
Locally-redunded

Network

- * Virtual network ⓘ
VNet01
- * Subnet ⓘ
Server (10.0.1.0/24)
- * Public IP address ⓘ
(new) packt-ip
- * Network security group (firewall) ⓘ
(new) packt-nsg

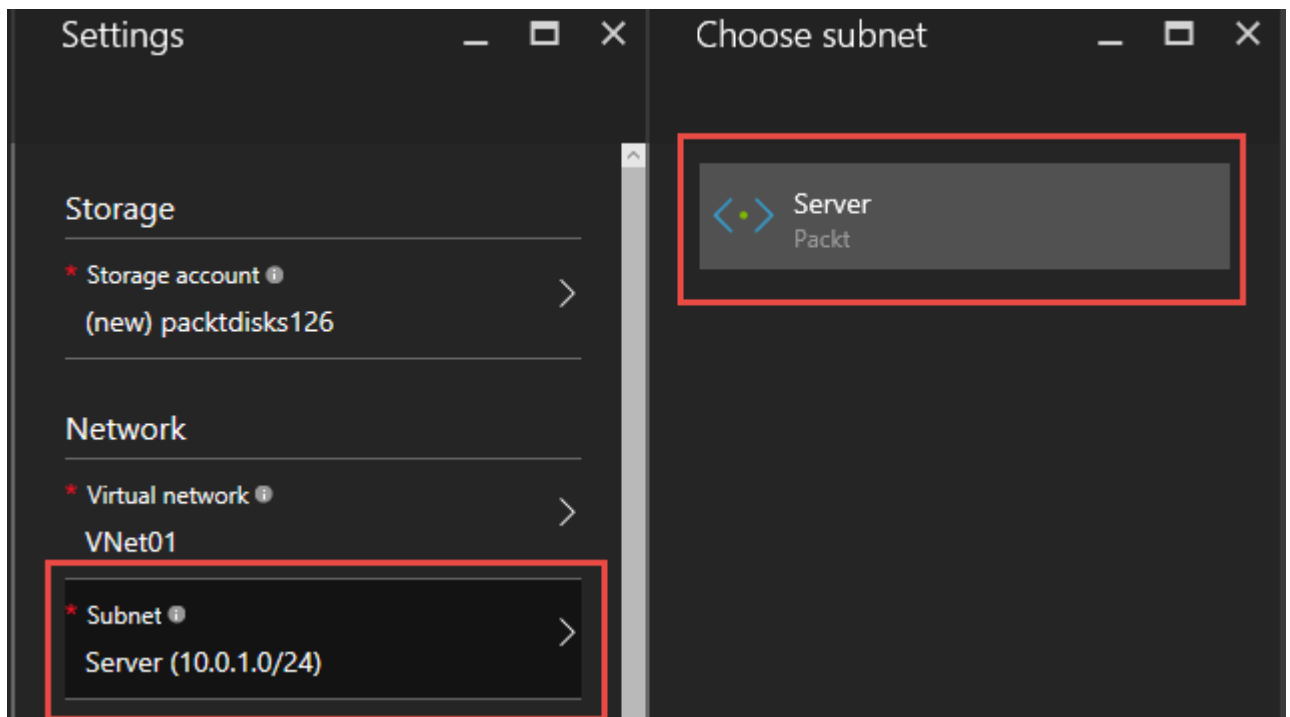
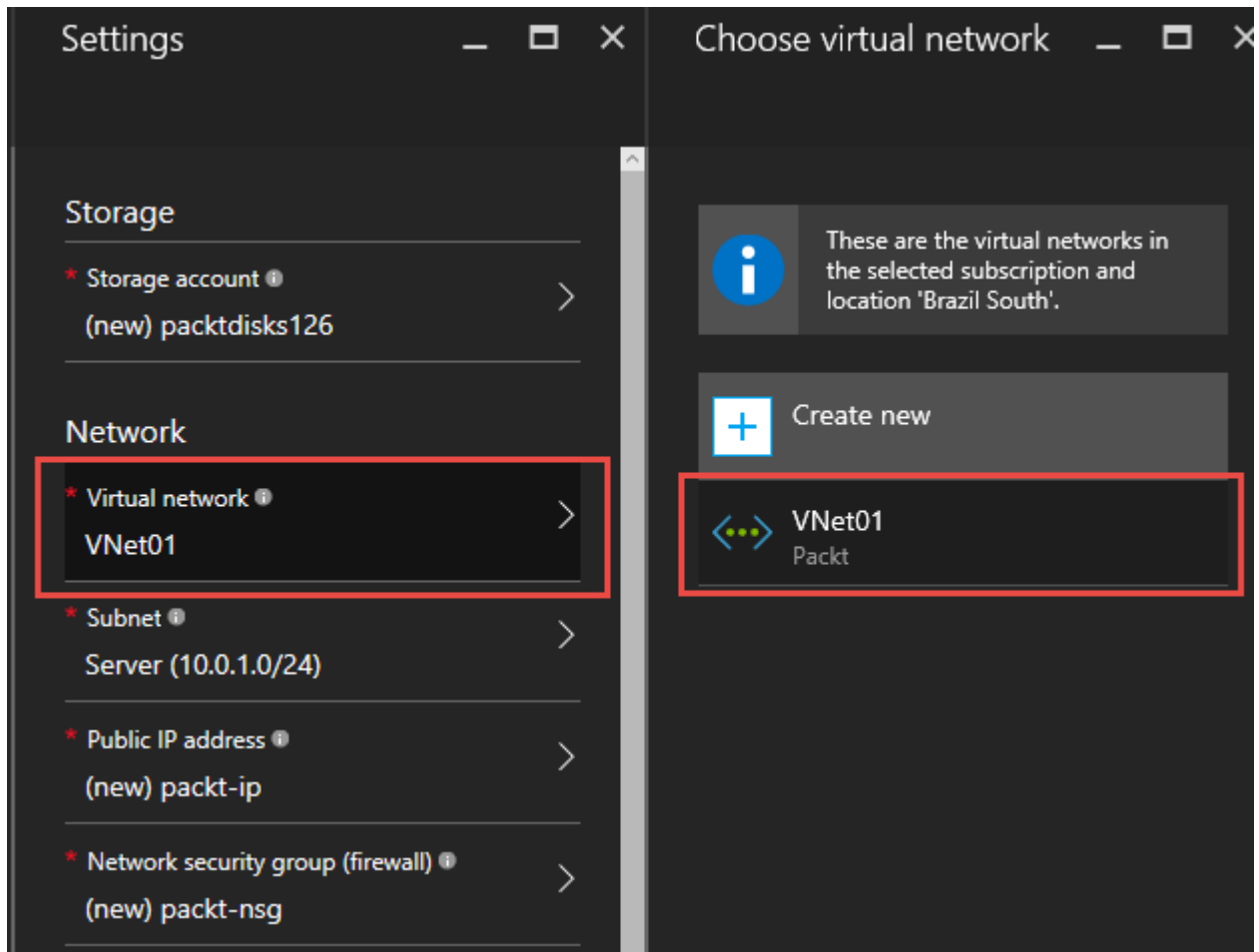

Settings



Storage

* Storage account ⓘ
(new) packtdisks126 >

Network

* Virtual network ⓘ
VNet01 >

* Subnet ⓘ
Server (10.0.1.0/24) >

* Public IP address ⓘ
(new) packt-ip >

* Network security group (firewall) ⓘ
(new) packt-nsg >

Choose public IP address

Dynamic public IP addresses that are not in use won't have an IP address assigned.



These are the public ip addresses in the selected subscription 'South'.



Create new



None

Settings

Storage

* Storage account ⓘ
(new) packtdisks126

Network

* Virtual network ⓘ
VNet01

* Subnet ⓘ
Server (10.0.1.0/24)

* Public IP address ⓘ
(new) packt-ip

* Network security group (firewall) ⓘ
(new) packt-nsg

Choose network securi...



These are the network security groups in the selected subscription and location 'Brazil South'.



Create new



None

Settings



Storage

* Storage account ⓘ
(new) packtdisks948 >

Network

* Virtual network ⓘ
VNet01 >

* Subnet ⓘ
Server (10.0.1.0/24) >

* Public IP address ⓘ
(new) packt-ip >

* Network security group (firewall) ⓘ
(new) packt-nsg >

Extensions

Extensions ⓘ
No extensions >

Extensions



Add new features, like configuration management or antivirus protection, to [Learn more](#) ⓘ

No extensions

[Add extension](#)

New



Settings



Storage

- * Storage account ⓘ
(new) packtdisks948 >

Network

- * Virtual network ⓘ
VNet01 >
- * Subnet ⓘ
Server (10.0.1.0/24) >
- * Public IP address ⓘ
(new) packt-ip >
- * Network security group (firewall) ⓘ
(new) packt-nsg >

Extensions

- Extensions ⓘ
No extensions >

High availability

- * Availability set ⓘ
None >

Change availability set



 Create new

 None

Monitoring

Boot diagnostics ⓘ

Disabled Enabled

Guest OS diagnostics ⓘ

Disabled Enabled

* Diagnostics storage account ⓘ

(new) packtdiag439



Settings



Network

- * Virtual network ⓘ
VNet01 >
- * Subnet ⓘ
Server (10.0.1.0/24) >
- * Public IP address ⓘ
(new) packt-ip >
- * Network security group (firewall) ⓘ
(new) packt-nsg >

Extensions

- Extensions ⓘ
No extensions >

High availability

- * Availability set ⓘ
None >

Monitoring

Boot diagnostics ⓘ

Disabled Enabled

Guest OS diagnostics ⓘ

Disabled Enabled

- * Diagnostics storage account ⓘ
(new) packtdiag392 >

Choose storage account



No storage accounts found in the selected subscription



Create new

Create virtual machine

- 1 Basics Done ✓
- 2 Size Done ✓
- 3 Settings Done ✓
- 4 Summary Windows Server 2016 Datacent... >

Summary

i Validation passed

Basics

| | |
|----------------|--------------------------------|
| Subscription | Visual Studio Premium with MSD |
| Resource group | Packt |
| Location | Brazil South |

Settings

| | |
|-----------------------------------|----------------------|
| Computer name | packt |
| Disk type | HDD |
| User name | flo |
| Size | Standard D1 v2 |
| Storage account | (new) packtdisks948 |
| Virtual network | VNet01 |
| Subnet | Server (10.0.1.0/24) |
| Public IP address | (new) packt-ip |
| Network security group (firewall) | (new) packt-nsg |
| Availability set | None |
| Guest OS diagnostics | Disabled |
| Boot diagnostics | Enabled |
| Diagnostics storage account | (new) packtdiag392 |

Search resources

Deployment started...

Remote Desktop Connection

Computer: [redacted]

User name: [redacted]

You will be asked for credentials when you connect.

Show Options Connect Help

packt
Virtual machine

Connect Start Restart Stop Delete

Essentials ^

Resource group
Packt

Status
Running

Location
Brazil South

Subscription name
Visual Studio Premium with MSDN

Subscription ID
4a8ad611-6c01-4f99-ba5e-2cad700afc54

Computer name
packt

Operating system
Windows

Size
Standard D1 v2 (1 core

Public IP address/DNS name
191.234.186.220/<non

Virtual network/subnet
VNet01/Server

Search (Ctrl+/)

Overview

Activity log

Access control (IAM)

Tags

Diagnose and solve problems

Remote Desktop Connection

The publisher of this remote connection can't be identified. Do you want to connect anyway?

This remote connection could harm your local or remote computer. Do not connect unless you know where this connection came from or have used it before.

Publisher: **Unknown publisher**









Type: Remote Desktop Connection

Remote computer: [REDACTED]





Don't ask me again for connections to this computer

Show Details

Connect Cancel

| NAME | TYPE | LOCATION | |
|---|-------------------|--------------|-----|
|  packt | Virtual machine | Brazil South | ... |
|  packt710 | Network inter... | Brazil South | ... |
|  packt-nsg | Network secu... | Brazil South | ... |
|  packt-ip | Public IP addr... | Brazil South | ... |
|  VNet01 | Virtual network | Brazil South | ... |
|  packtdiag392 | Storage accou... | Brazil South | ... |
|  packtdisks948 | Storage accou... | Brazil South | ... |
|  packtsrg | Storage accou... | Brazil South | ... |

 **packt710**
Network interface

-  Overview
-  Activity log
-  Access control (IAM)
-  Tags

SETTINGS

 Delete

Essentials ^

Resource group
Packt

Location
Brazil South

Subscription name
Visual Studio Premium with MSDN

Subscription ID
4a8ad611-6c01-4f99-ba5e-2cad700afc54

Private IP address
10.0.1.4

Virtual network/subnet
VNet01/Server

Public IP address
191.234.186.220 (packt)

Network security group
packt-nsg

Attached to
packt

Enter your credentials

These credentials will be used to connect to [REDACTED]



Domain: MicrosoftAccount

Remember me

More choices



 Use a different account

OK

Cancel



Dashboard

- Local Server
- All Servers
- File and Storage Services ▶

WELCOME TO SERVER MANAGER

QUICK START

WHAT'S NEW

LEARN MORE

- 1 Configure this local server
- 2 Add roles and features
- 3 Add other servers to manage
- 4 Create a server group
- 5 Connect this server to cloud services

ROLES AND SERVER GROUPS

Roles: 1 | Server groups: 1 | Servers total: 1

| | |
|--|------------------------------------|
| | File and Storage Services 1 |
| | Manageability |
| | Events |
| | Performance |
| | BPA results |

| | |
|--|---------------------|
| | Local Server |
| | Manageability |
| | Events |
| | Services |
| | Performance |
| | BPA results |

10/29/2016 6:15

Windows PowerShell console window showing Azure subscription details and a table of resources.

Subscription name: **Visual Studio Premium with MSDN**
Subscription ID: 4a8ad611-6c01-4f99-ba5e-2cad700afc54
Last deployment: 29/10/2016 (Succeeded)
Location: Brazil South

Filter items...

| NAME | TYPE | LOCATION | |
|-----------|------------------|--------------|-----|
| packt | Virtual machine | Brazil South | ... |
| packt710 | Network inter... | Brazil South | 1 |
| packt-nsg | Network secu... | Brazil South | ... |

packt Network

Search (0)

- Overview
- Activity I
- Access c
- Tags

SETTINGS

- IP config
- DNS ser



packt710 - IP configurations

Network interface



Save



Discard



Search (Ctrl+/)



Overview



Activity log



Access control (IAM)



Tags

SETTINGS



IP configurations

1



DNS servers



Network security group



Properties



Locks



Automation script

SUPPORT + TROUBLESHOOTING



Effective security rules



Effective routes



New support request

IP forwarding settings

IP forwarding

Disabled

Enabled

Virtual network

VNet01

IP configurations

* Subnet

Server (10.0.1.0/24)



Search IP configurations

| NAME | TYPE | PRIVATE IP ADDRESS | PUB |
|-----------|---------|--------------------|-----|
| ipconfig1 | Primary | 10.0.1.4 (Dynamic) | 191 |

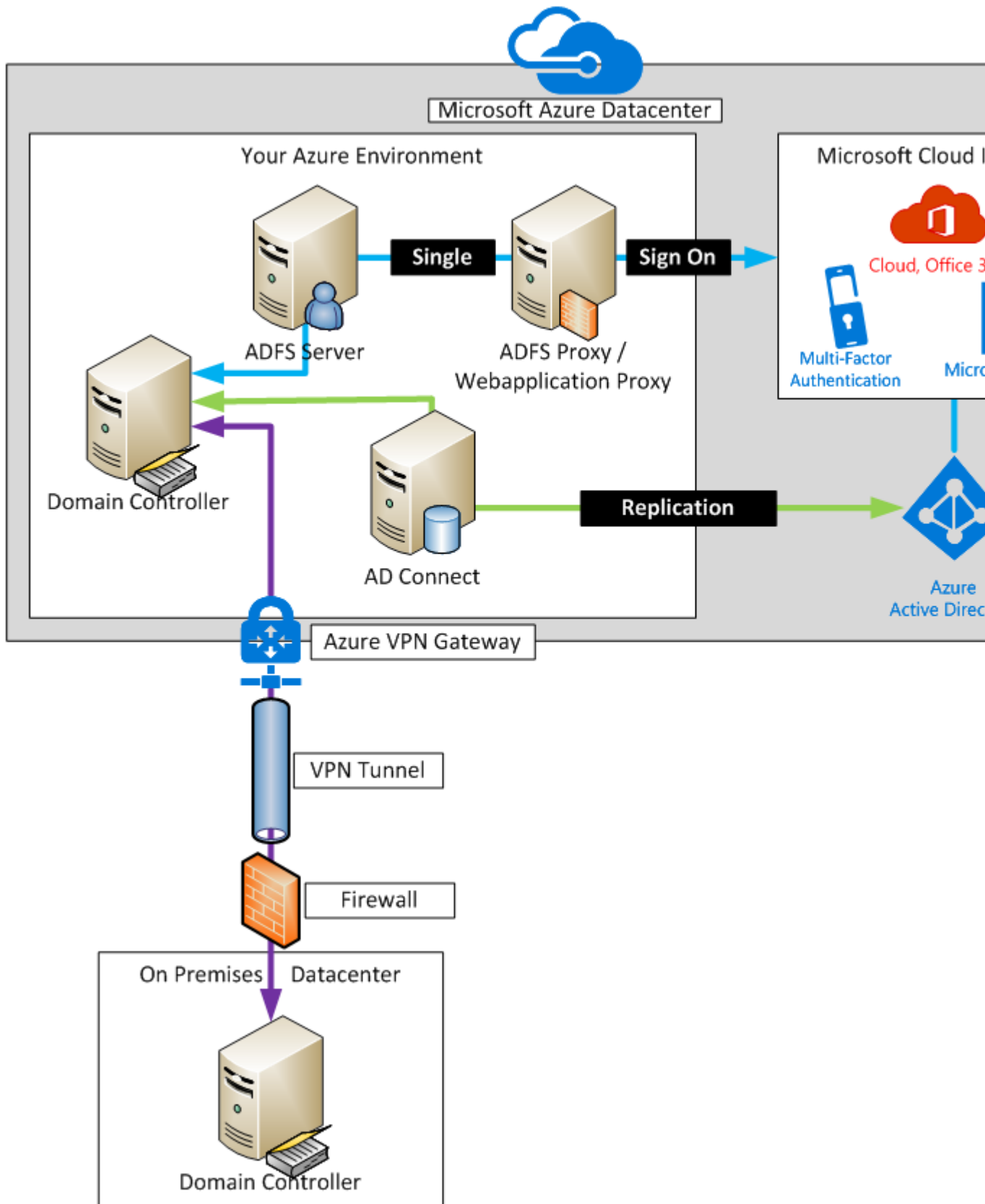

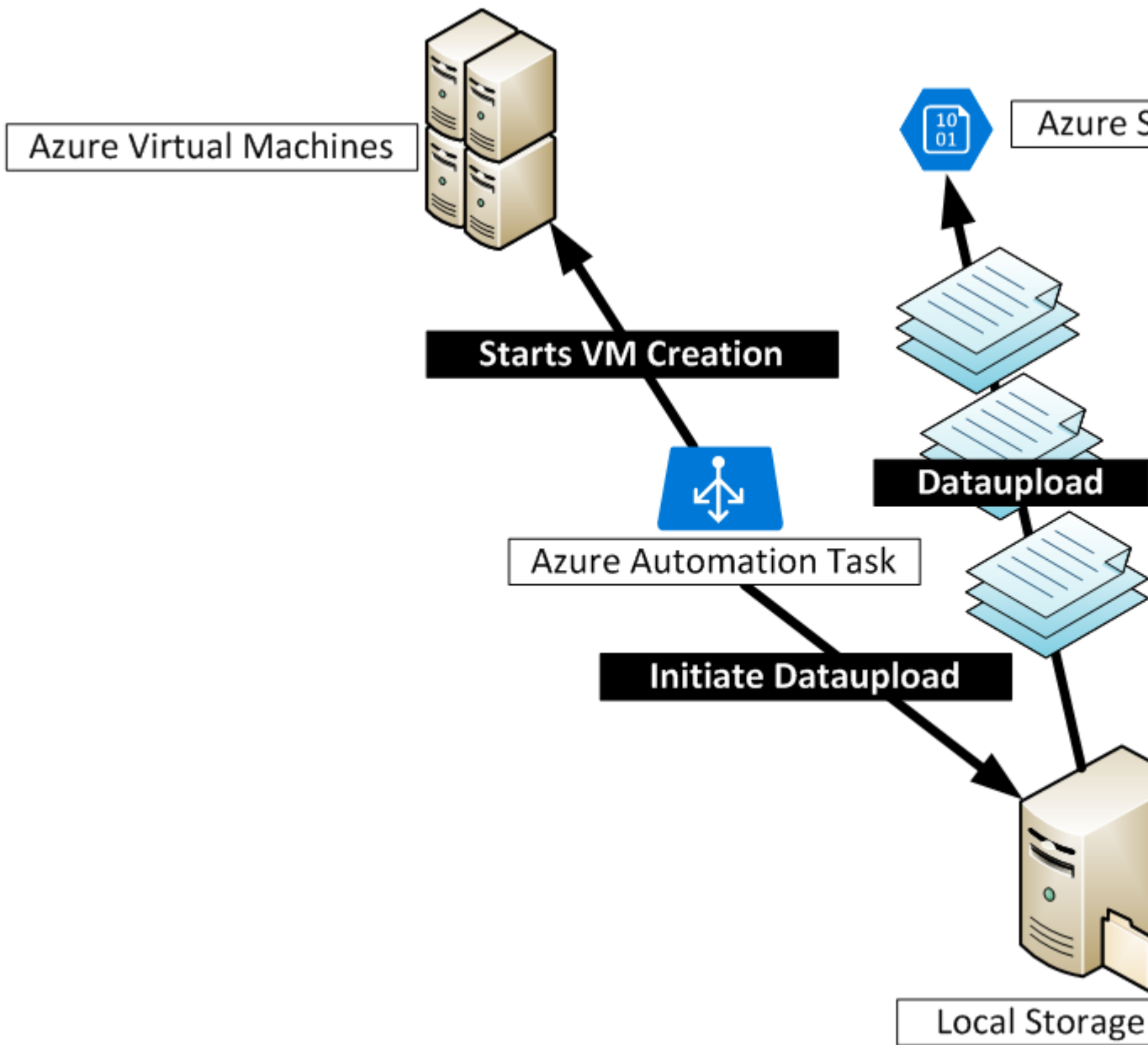

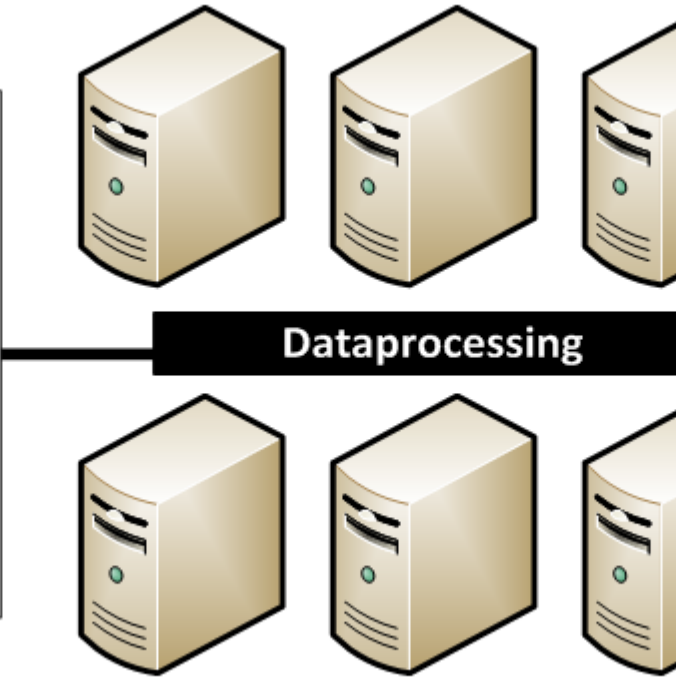
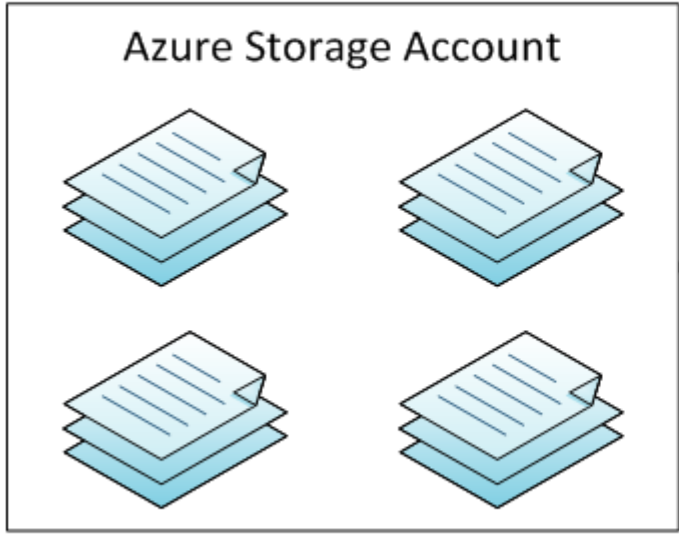

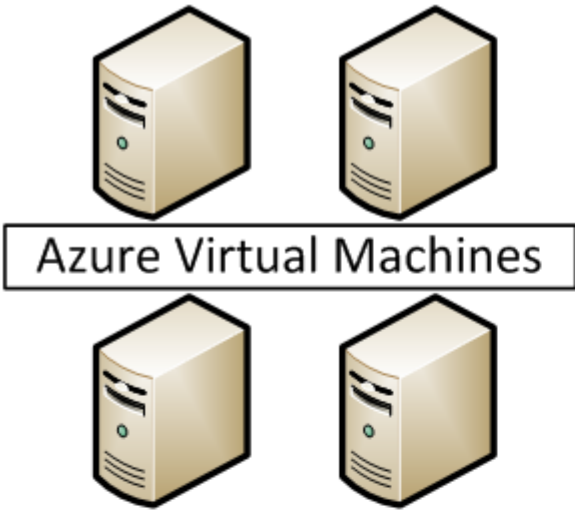

Starts VM decommission



Azure Automation Task

Initiate Download



Data

Loc

On Premises Environment



Storage Replication



Azure Environment

On Premises Environment

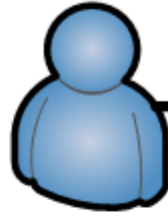

Azure Environment

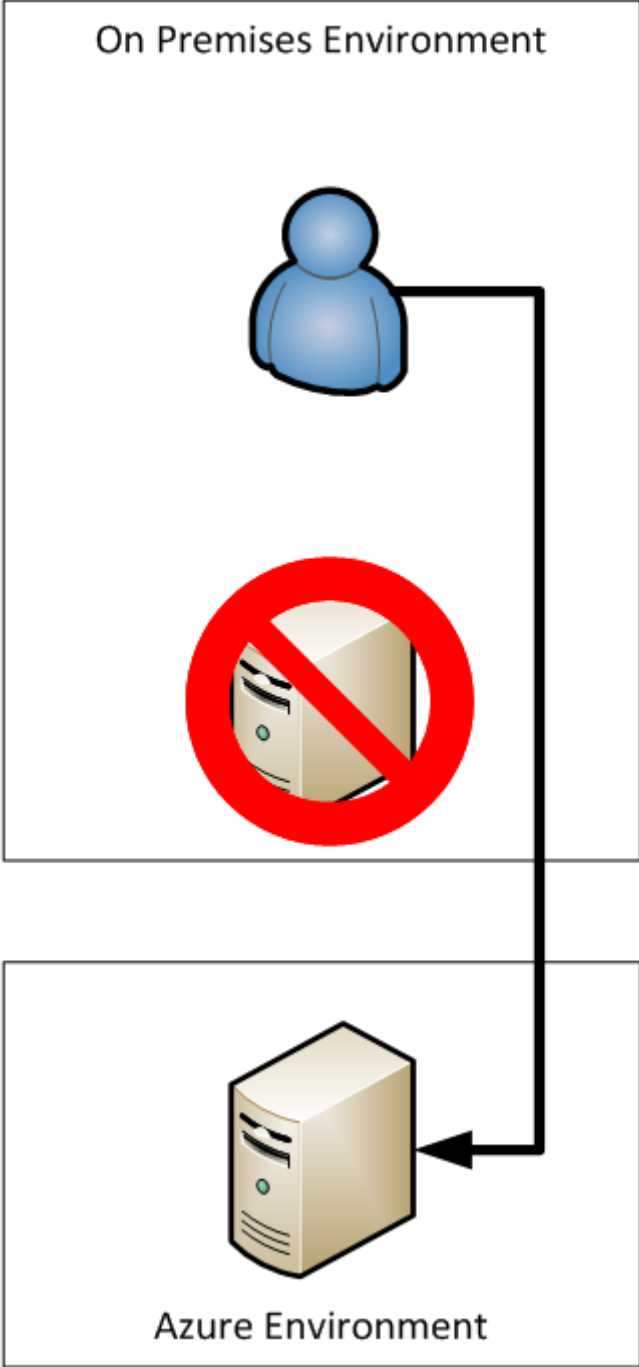

Chapter 7: Implementing Azure Cloud Services

Cloud
Services

Cloud
Services
Package

Code Assets



Service Definition File



Cloud Services

Cloud Services Package

Code Assets



Service Definition File



.csdef



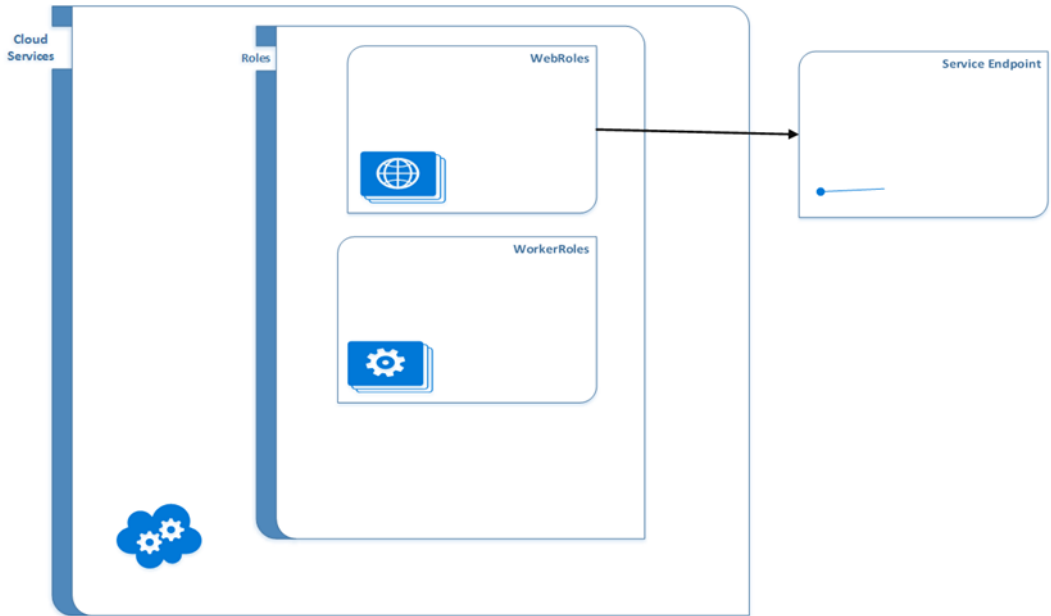



New

- Resource groups
- All resources
- Recent
- App Services
- Virtual machines (classic)
- Virtual machines
- SQL databases
- Cloud services (classic)
- Security Center
- Subscriptions
- Azure Active Directory
- Monitor
- Billing
- Help + support

Dashboard

+ New dashboard

Edit dashboard

Share

All resources
ALL SUBSCRIPTIONS

- acdppbookstor
- acdeventhubdev-ns
- acdmlwsp
- acdcsiotdemo
- Dtlacctestlab
- acdiotthdev
- acdappservplan
- acddemoportal
- acddemoportal

...

Service health MY RESOURCES

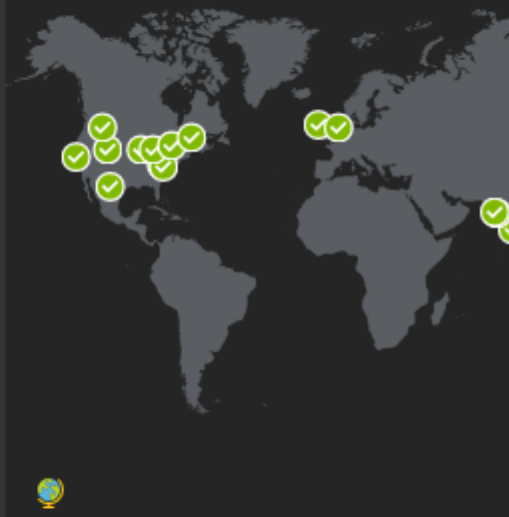



New



Search the marketplace

MARKETPLACE

See all

Compute

Networking

Storage

Web + mobile

Databases

Intelligence + analytics

Internet of things

Enterprise integration

Security + identity

Developer tools

Monitoring + management

Add-ons

Containers

Compute



Azure Container Service
A pre-configured environment for scalable deployment and management of containerized



Function App
Write any function in minutes – whether to run a simple job that cleans up a database or build a



Batch Service
Azure Batch provides job scheduling and resource management for HPC applications.



Service Fabric Cluster
Create a customized Service Fabric cluster to host your service fabric micro services.

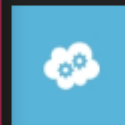

Cloud service
Deploy highly-available, infinitely-scalable applications and APIs.



New

Resource groups

All resources

Recent

App Services

Virtual machines (classic)

Virtual machines

SQL databases

Cloud services (classic)

Security Center

Subscriptions

Azure Active Directory

Monitor

Billing

Help + support

Dashboard

+ New dashboard

Edit dashboard

Share

All resources
ALL SUBSCRIPTIONS

acdppbookstor

acdeventhubdev-ns

acdmlwsp

acdcsiotdemo

Dtlacdtestlab

acdiotthdev

acdappservplan

acddemoportal

acddemoportal

Service health
MY RESOURCES





Cloud services (classic)

Windows Server User Group Berlin



Add



Columns



Refresh

Subscriptions: Visual Studio Enterprise



NAME

PRODUCTION

STAGING



acdcsiotdemo



Cloud service (classic)

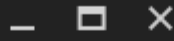

* DNS name

Enter the name

.cloudapp.net



* Subscription

Visual Studio Enterprise



* Resource group ⓘ

Create new Use existing



* Location

West Europe



Package

(Optional) Select a package



Certificates

(Optional) Add certificates



Pin to dashboard



Create

Automation options



Cloud service (classic) [Window Title Bar]



* DNS name
acdppbookcs ✓
.cloudapp.net

* Subscription
Visual Studio Enterprise

* Resource group ⓘ
 Create new Use existing
[Empty dropdown menu with error icon]

* Location
West Europe

Package
(Optional) Select a package >

Certificates
(Optional) Add certificates 🔒

Pin to dashboard

[Create](#) [Automation options](#)

Cloud service (classic) [Window Title Bar]



* DNS name

acdppbookcs ✓

cloudapp.net

* Subscription

Visual Studio Enterprise ▼

* Resource group ⓘ

Create new Use existing

[Empty dropdown menu with red error icon]

* Location

West Europe ▼

Package
(Optional) Select a package >

Certificates
(Optional) Add certificates 🔒

Pin to dashboard

Create

Automation options

Cloud service (classic)



* DNS name

acdppbookcs ✓
.cloudapp.net

* Subscription

Visual Studio Enterprise

* Resource group ⓘ

Create new Use existing

- acdcsiotdemo
- acddev
- acdiotdemo
- acdiotdev
- acdml
- acdppbook
- acdttestlabRG182808

The value should not be empty.

Pin to dashboard

Create

Automation options

Cloud service (classic)



* DNS name

acdppbookcs ✓

.cloudapp.net

* Subscription

Visual Studio Enterprise

* Resource group ⓘ

Create new Use existing

acdppbook

* Location

West Europe

Japan West

North Central US

North Europe

South Central US

Southeast Asia

UK South

UK West

Pin to dashboard

Create

Automation options

Cloud service (classic) [Close]



* DNS name

acdppbookcs ✓
.cloudapp.net

* Subscription

Visual Studio Enterprise

* Resource group ⓘ

Create new Use existing

acdppbook

* Location

North Europe

Package
(Optional) Select a package >

Certificates
(Optional) Add certificates 🔒

Pin to dashboard

[Create](#) [Automation options](#)

Cloud service (classic) [Window Title Bar]



* DNS name
acdppbookcs ✓
.cloudapp.net

* Subscription
Visual Studio Enterprise

* Resource group ⓘ
 Create new Use existing
acdppbook

* Location
North Europe

Package
(Optional) Select a package >

Certificates
(Optional) Add certificates 🔒

Pin to dashboard

Create

[Automation options](#)



Cloud services (classic)

Windows Server User Group Berlin



+ Add



Columns



Refresh

Subscriptions: Visual Studio Enterprise

Filter items...

NAME

PRODUCTION

STAGING

 acdcsiotdemo

 acdppbookes





CLOUD SERVICES (CLASSIC)



acdppbookcs - Production

Cloud service (classic)

Production slot

Upload

Start

Switch

Search (Ctrl+/)

Overview

Activity log

Access control (IAM)

SETTINGS

Antimalware

Certificates

Configuration

Extensions

Remote Desktop

Scale

Properties

Locks

SUPPORT + TROUBLESHOOTING

Production

Staging

Resource group

acdppbook

Status

Location

North Europe

Subscription name

Visual Studio Enterprise

Subscription ID

02f13438-c22f-4f1b-ad33-0f9f2eef0ba6

Site UR

-

Public I

-

Deploy

-

Deploy

-

Deploy

-

Roles and instances

NAME

STATUS

You have nothing deployed to the current environme



CLOUD SERVICES (CLASSIC)



acdppbookcs - Staging

Cloud service (classic)

Staging slot

Upload

Start

Swap

Search (Ctrl+/)

Overview

Activity log

Access control (IAM)

SETTINGS

Antimalware

Certificates

Configuration

Extensions

Remote Desktop

Scale

Properties

Locks

SUPPORT + TROUBLESHOOTING

No deployment

Essentials

Resource group

acdppbook

Status

-

Location

North Europe

Subscription name

Visual Studio Enterprise

Subscription ID

02f13438-c22f-4f1b-ad33-0f9f2eef0ba6

Site UR

-

Public I

-

Deploy

-

Deploy

-

Deploy

-

Roles and instances

NAME

STATUS

You have nothing deployed to the current environme



CLOUD SERVICES (CLASSIC)



acdppbookcs - Production

Cloud service (classic)

Production slot

Upload

Start

Switch

Search (Ctrl+/)

Overview

Activity log

Access control (IAM)

SETTINGS

Antimalware

Certificates

Configuration

Extensions

Remote Desktop

Scale

Properties

Locks

SUPPORT + TROUBLESHOOTING

Production

Staging

Resource group

acdppbook

Status

-

Location

North Europe

Subscription name

Visual Studio Enterprise

Subscription ID

02f13438-c22f-4f1b-ad33-0f9f2eef0ba6

Site UR

-

Public I

-

Deploy

-

Deploy

-

Deploy

-

Roles and instances

NAME

STATUS

You have nothing deployed to the current environme



CLOUD SERVICES (CLASSIC)



acdppbookcs - Production

Cloud service (classic)

Production slot

Upload

Start

Switch

Search (Ctrl+/)

Overview

Activity log

Access control (IAM)

SETTINGS

Antimalware

Certificates

Configuration

Extensions

Remote Desktop

Scale

Properties

Locks

SUPPORT + TROUBLESHOOTING

Production

Staging

Resource group

acdppbook

Status

-

Location

North Europe

Subscription name

Visual Studio Enterprise

Subscription ID

02f13438-c22f-4f1b-ad33-0f9f2eef0ba6

Site UR

-

Public I

-

Deploy

-

Deploy

-

Deploy

-

Roles and instances

NAME

STATUS

You have nothing deployed to the current environme

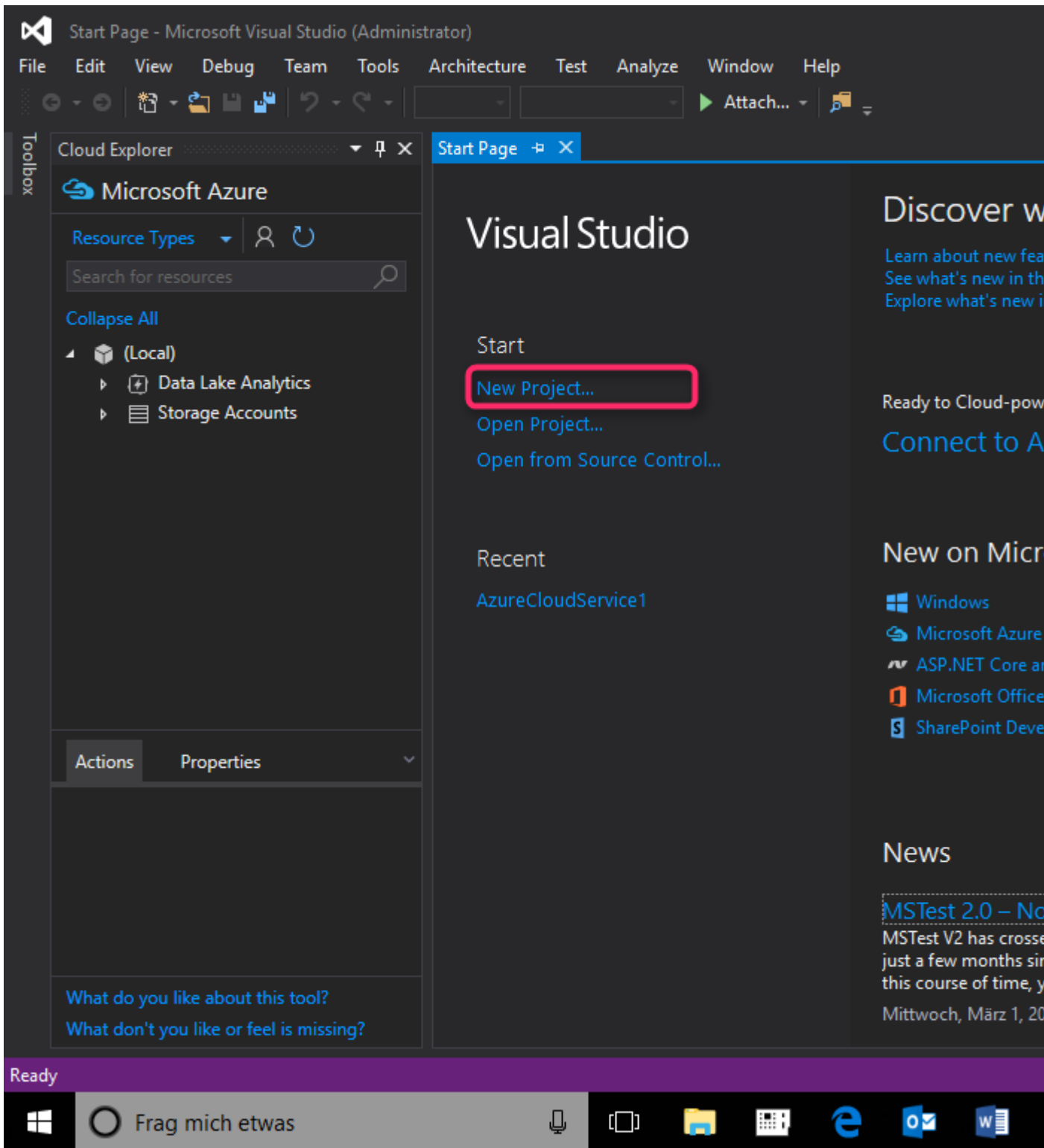

New Project

Recent

.NET Framework 4.5.2

Sort by: Default

Installed

Templates

Visual C#

Windows

Web

Office/SharePoint

Android

Cloud

Extensibility

iOS

LightSwitch

Reporting

Silverlight

Test

WCF

Workflow

Azure Data Lake

Data Factory



Azure Cloud Service

Visual C#



ASP.NET Web Application

Visual C#



Azure WebJob

Visual C#



Azure Mobile App

Visual C#



Azure Mobile Service

Visual C#



Azure Resource Group

Visual C#

[Click here to go online and find templates.](#)

Name:

ACDPPBookCS

Location:

c:\users\oliver michalski\documents\visual studio 2015\Projects

Solution name:

ACDPPBookCS

New Project

Recent

.NET Framework 4.5.2

Sort by: Default

Installed

Templates

Visual C#

Windows

Web

Office/SharePoint

Android

Cloud

Extensibility

iOS

LightSwitch

Reporting

Silverlight

Test

WCF

Workflow

Azure Data Lake

Data Factory



Azure Cloud Service

Visual C#



ASP.NET Web Application

Visual C#



Azure WebJob

Visual C#



Azure Mobile App

Visual C#



Azure Mobile Service

Visual C#



Azure Resource Group

Visual C#

[Click here to go online and find templates.](#)

Name:

ACDPPBookCS

Location:

c:\users\oliver michalski\documents\visual studio 2015\Projects

Solution name:

ACDPPBookCS

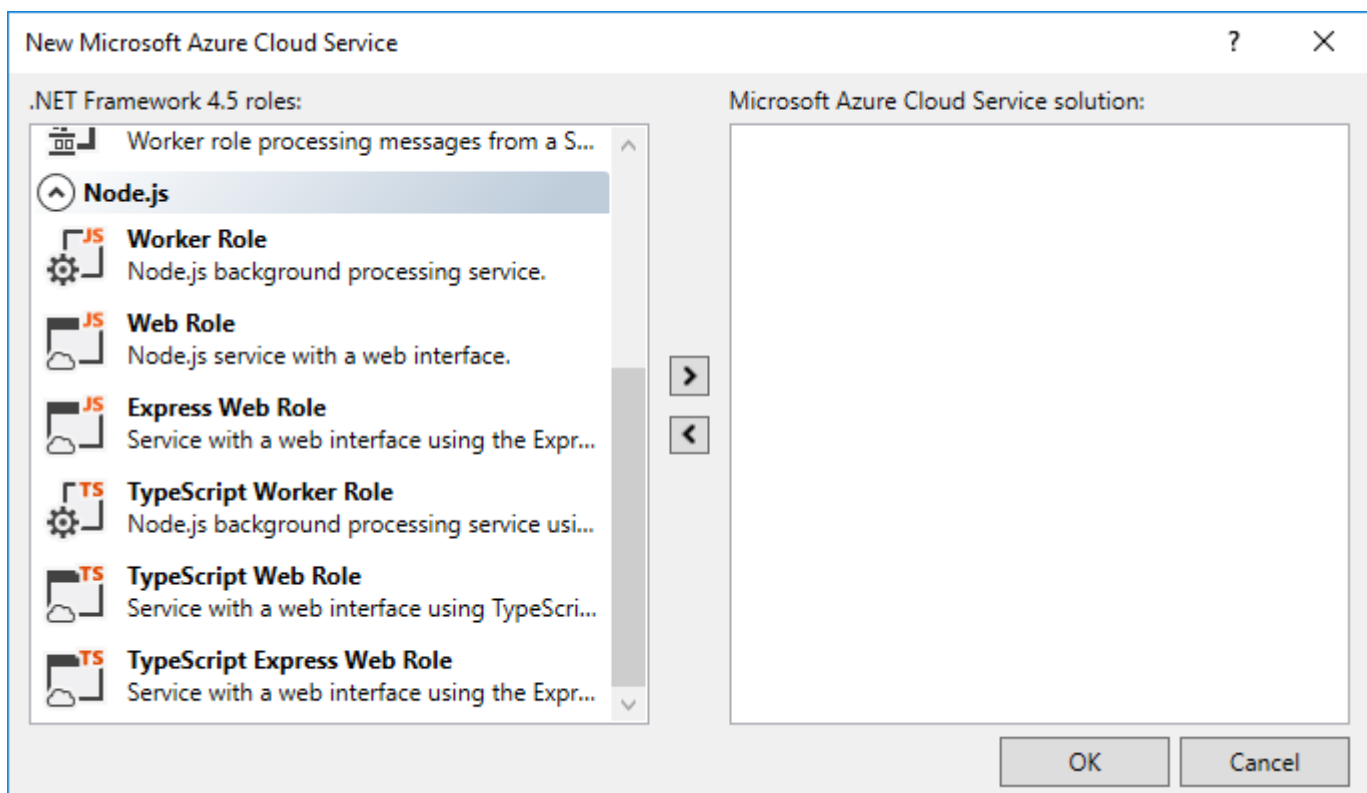
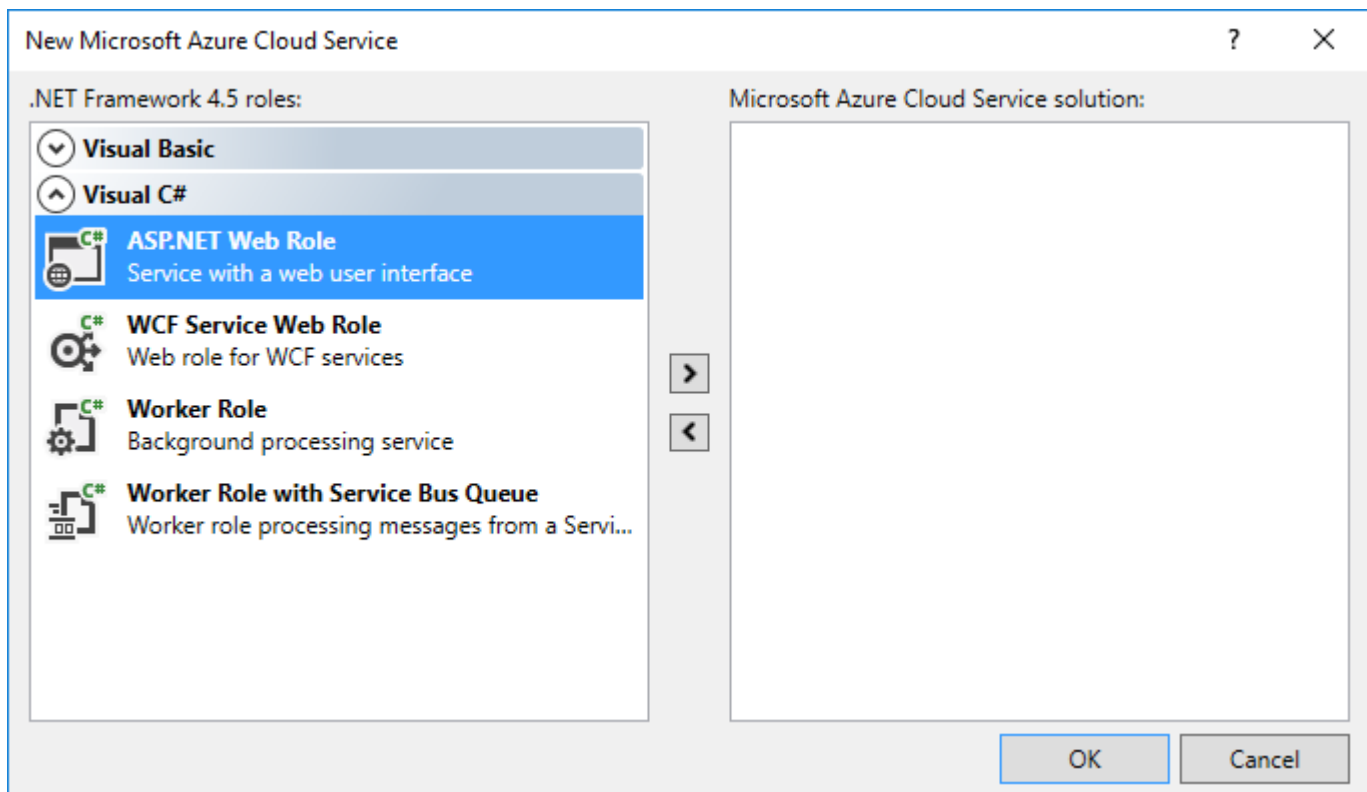

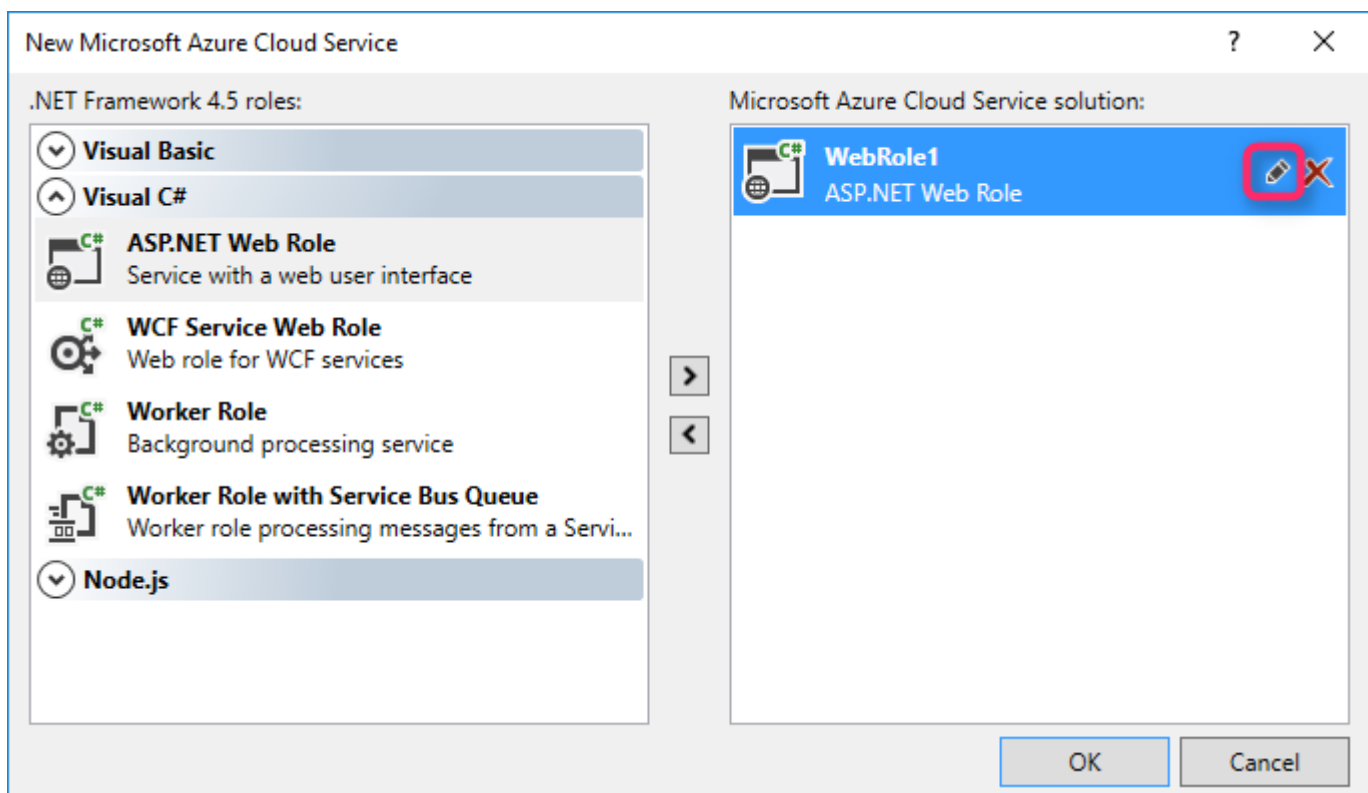
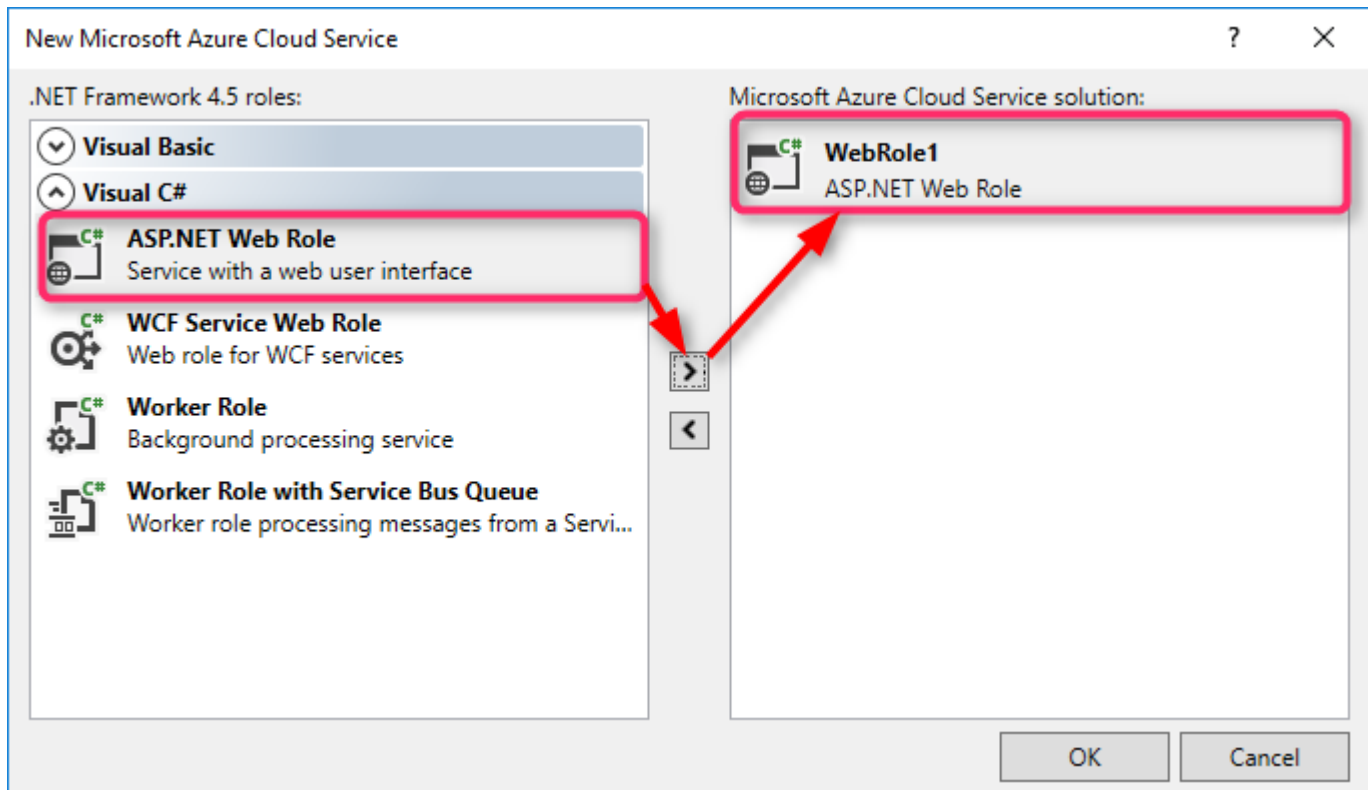

New Microsoft Azure Cloud Service



.NET Framework 4.5 roles:

- Visual Basic
- Visual C#
 - ASP.NET Web Role
Service with a web user interface
 - WCF Service Web Role
Web role for WCF services
 - Worker Role
Background processing service
 - Worker Role with Service Bus Queue
Worker role processing messages from a Servi...

Microsoft Azure Cloud Service solution:

ACDCSDemo
ASP.NET Web Role



OK Cancel

New ASP.NET Project - ACDCSDemo

Select a template:

Empty Web Forms **MVC** Web API Single Page Application

Azure API App Azure API App (Preview)

A project template for creating ASP.NET MVC applications. ASP.NET MVC allows you to create applications using the Model-View-Controller architecture. ASP.NET MVC includes many features that enable fast, test-driven development for applications that use the latest standards.

[Learn more](#)

Change Authentication

Authentication: **Individual User Accounts**

Add folders and core references for:

Web Forms MVC Web API

Add unit tests

Test project name:

OK

Change Authentication

- No Authentication
- Individual User Accounts
- Work And School Accounts
- Windows Authentication

For applications that store user profiles in a SQL Server database. Users can register, or sign in using their existing account for Facebook, Twitter, Google, Microsoft, or another provider.

[Learn more](#)

OK

Cancel

Change Authentication

- No Authentication
- Individual User Accounts
- Work And School Accounts
- Windows Authentication

For applications that authenticate users with Active Directory, Microsoft Azure Active Directory, or Office 365.

[Learn more](#)

Cloud - Single Organization ▼ i

Domain:

e.g. contoso.onmicrosoft.com i

Directory Access Permissions:

- Read directory data i
- More Options

OK

Cancel

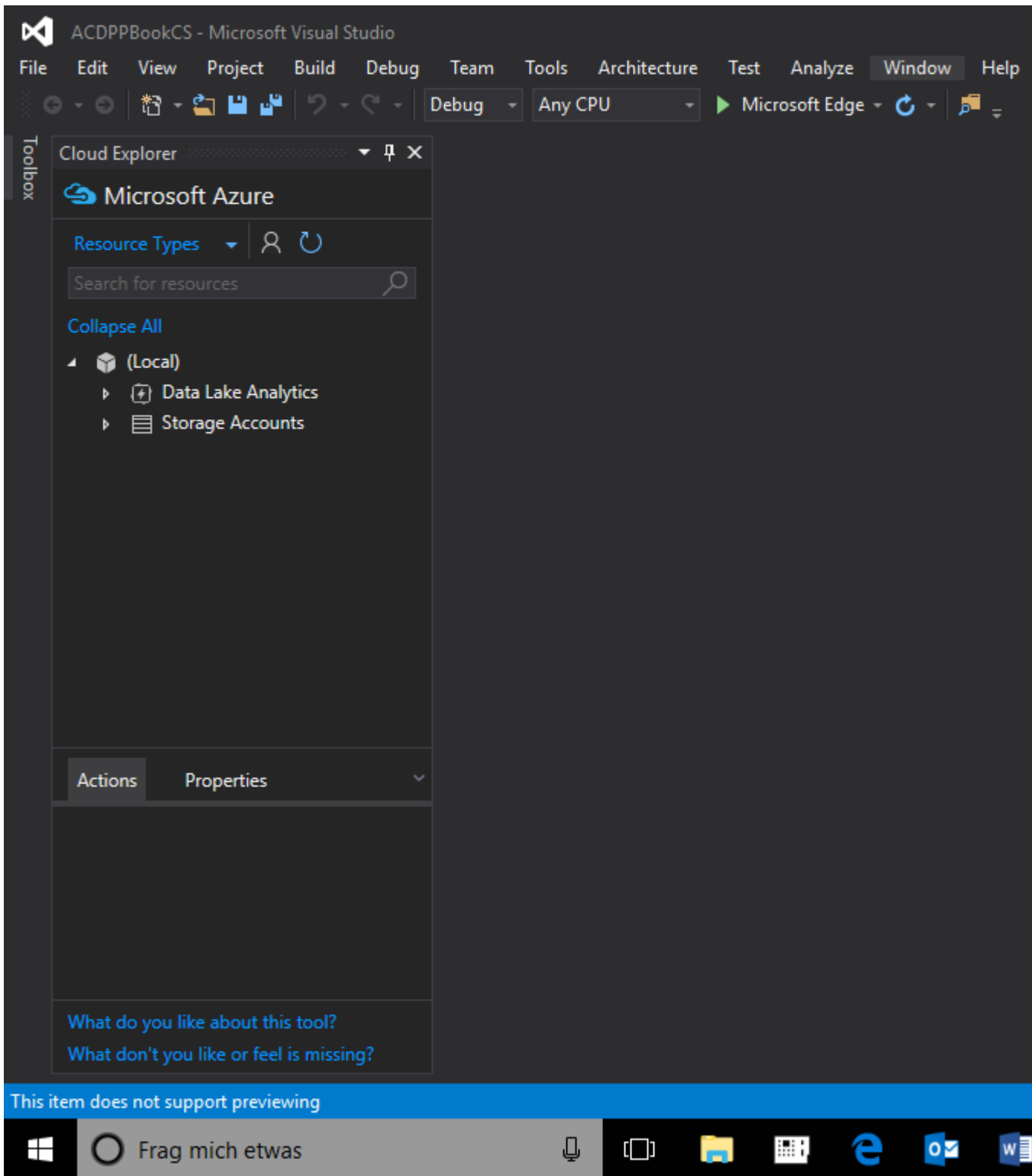

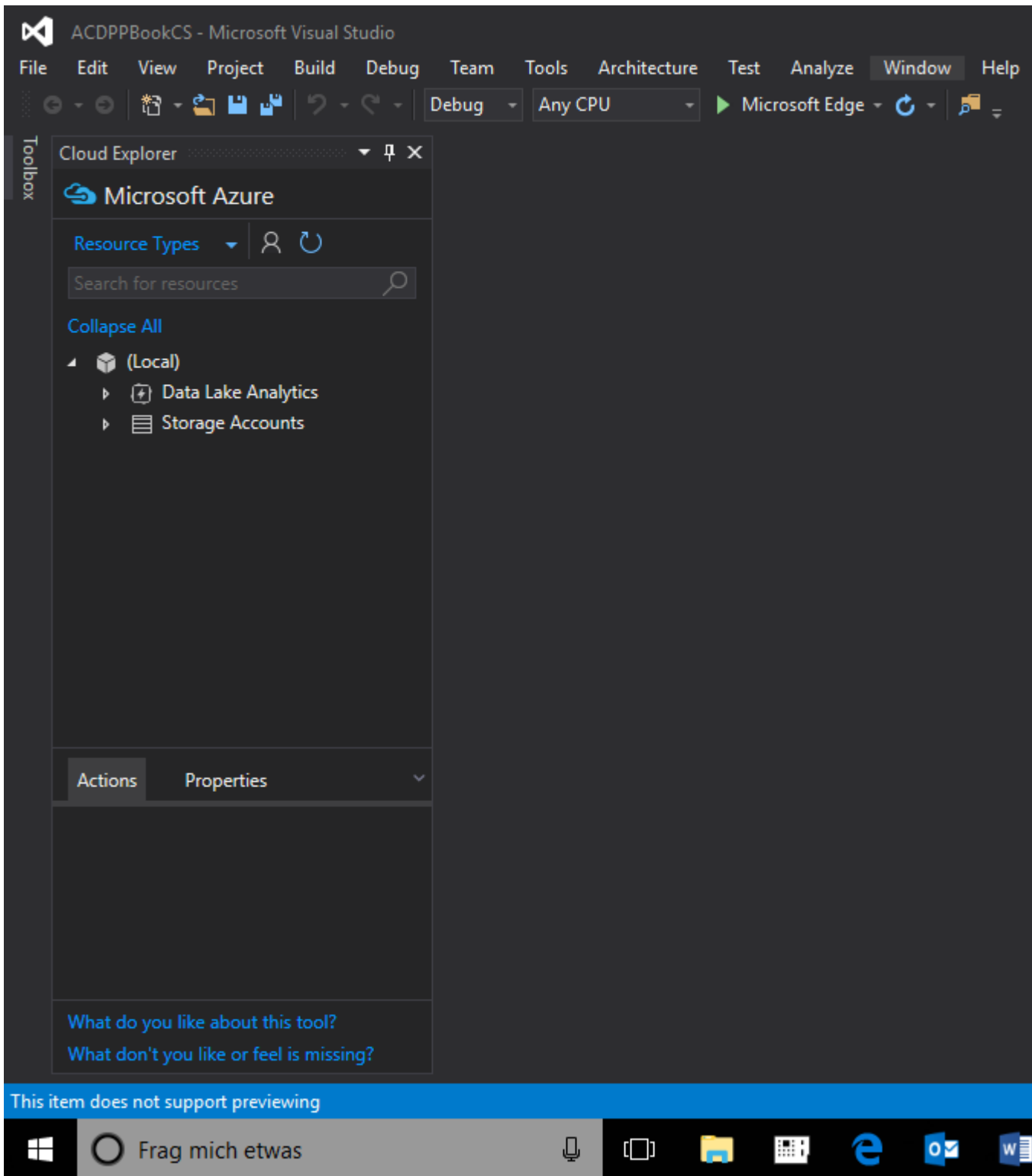

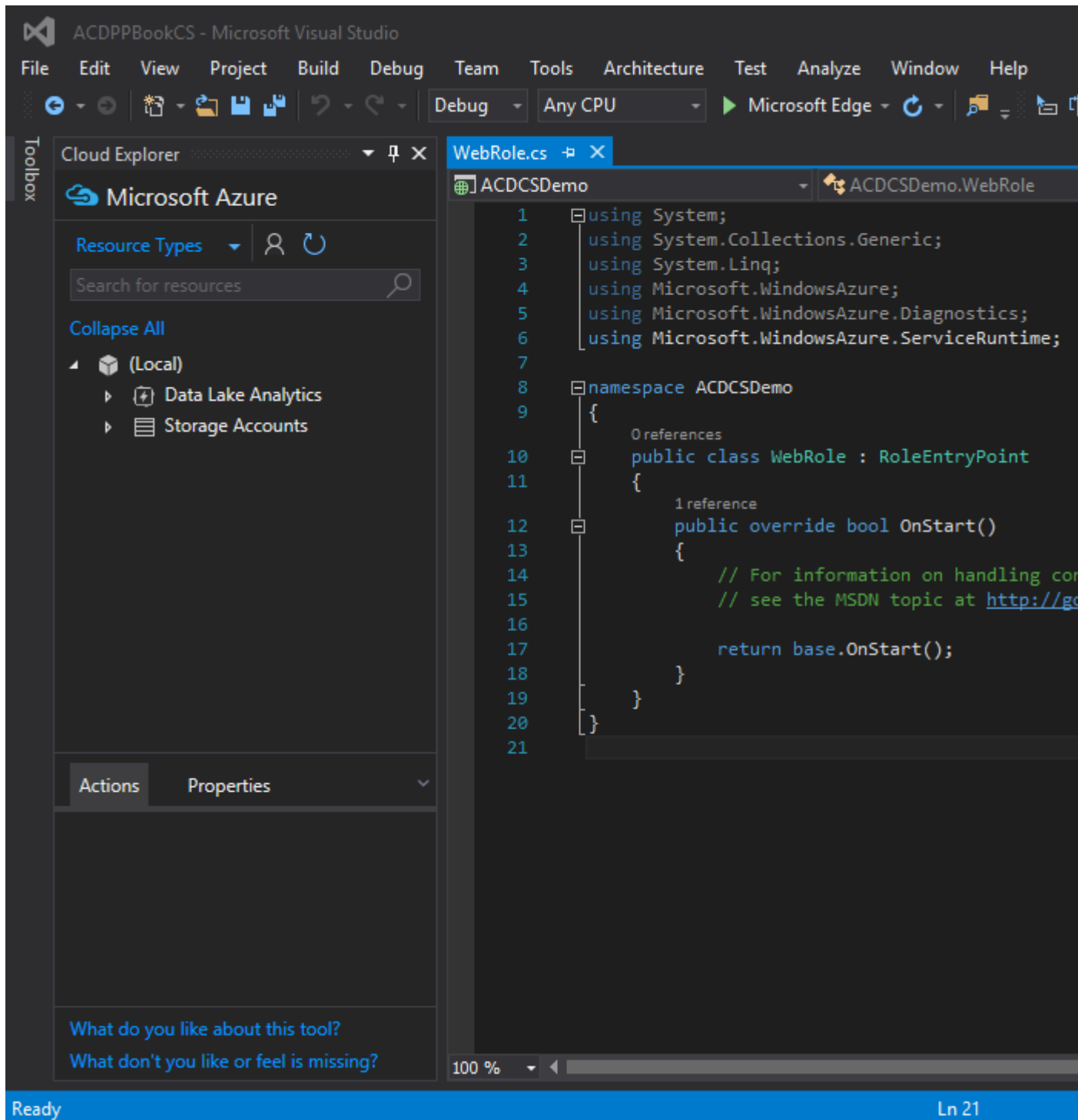

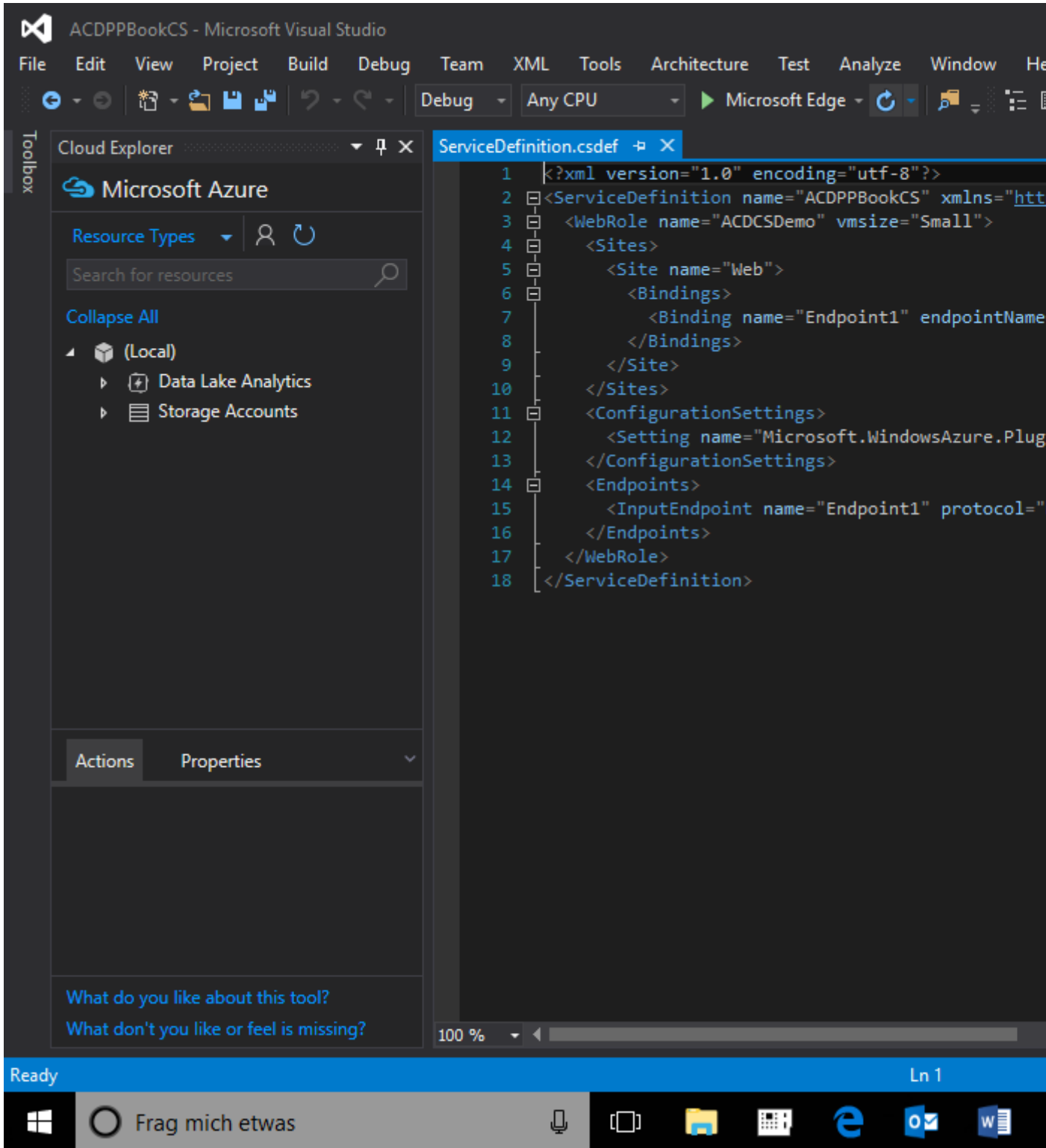

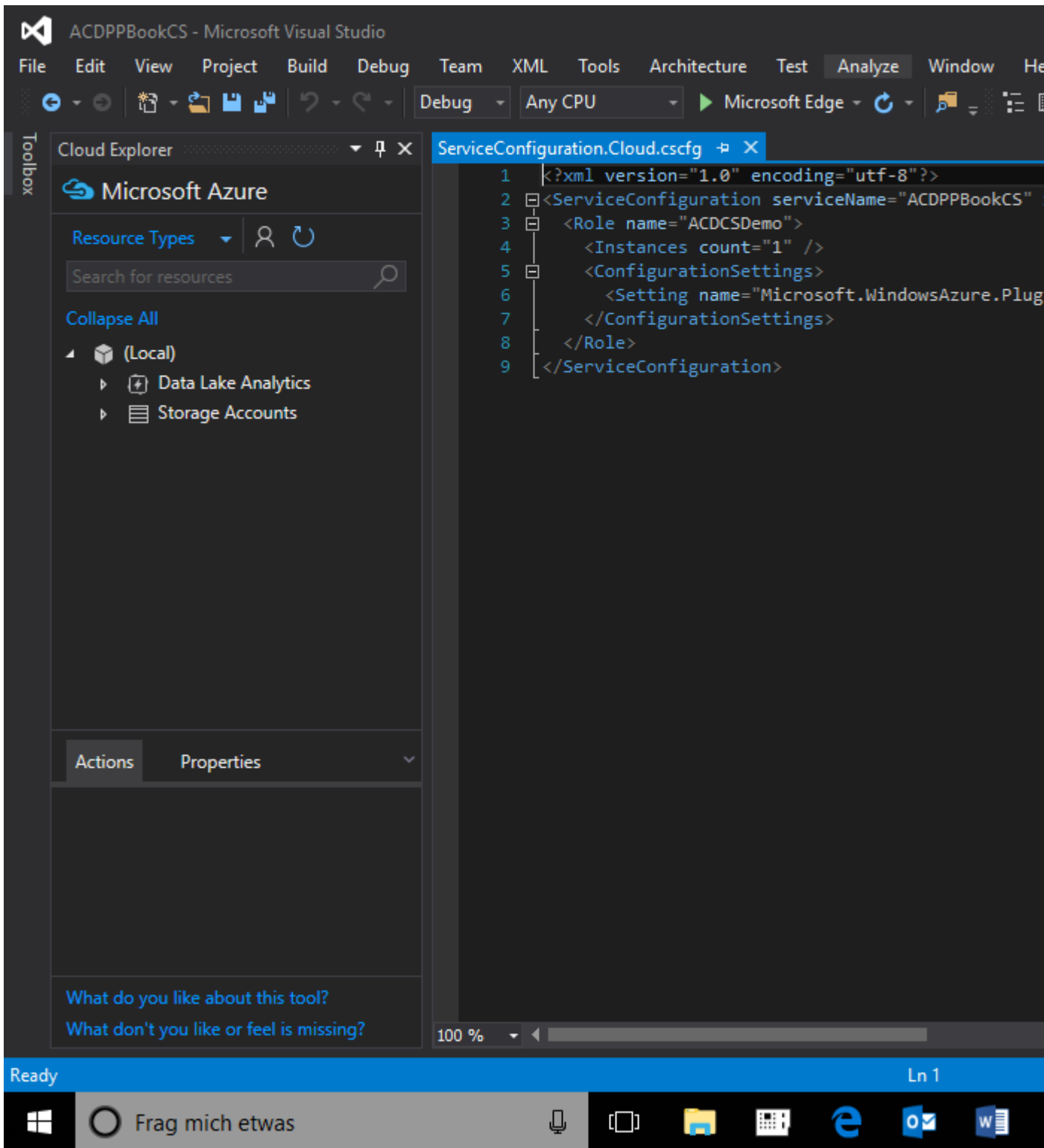

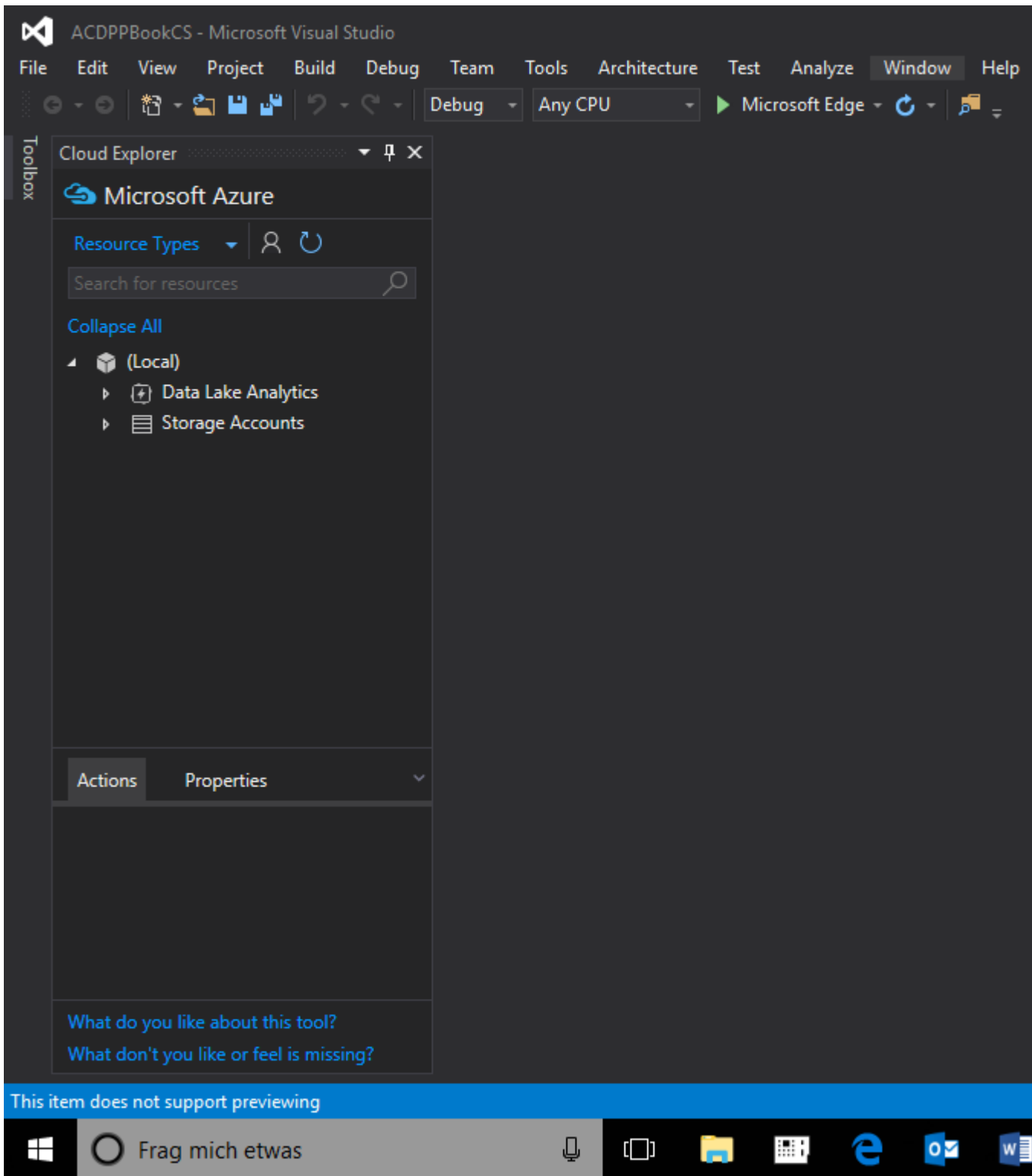

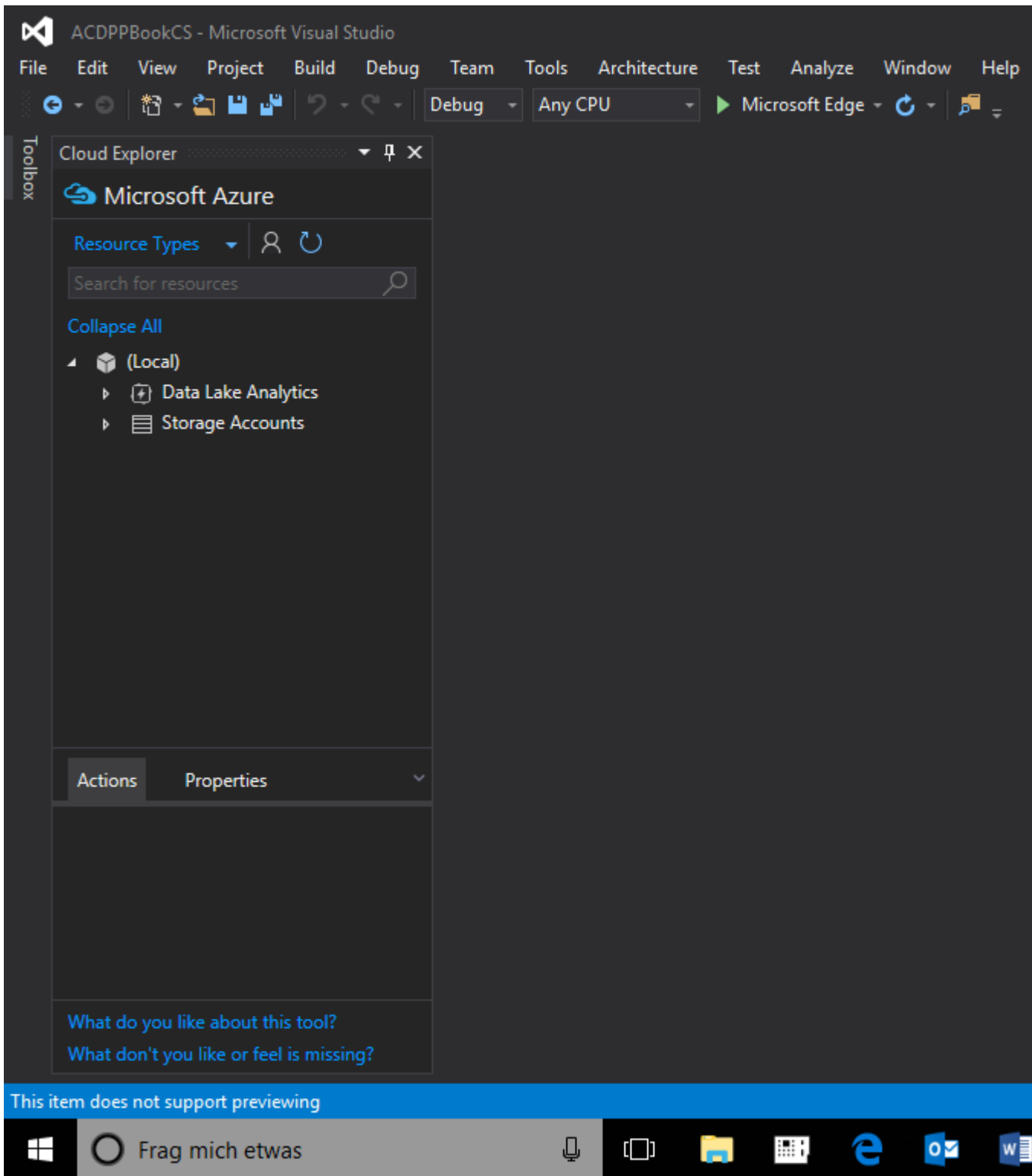

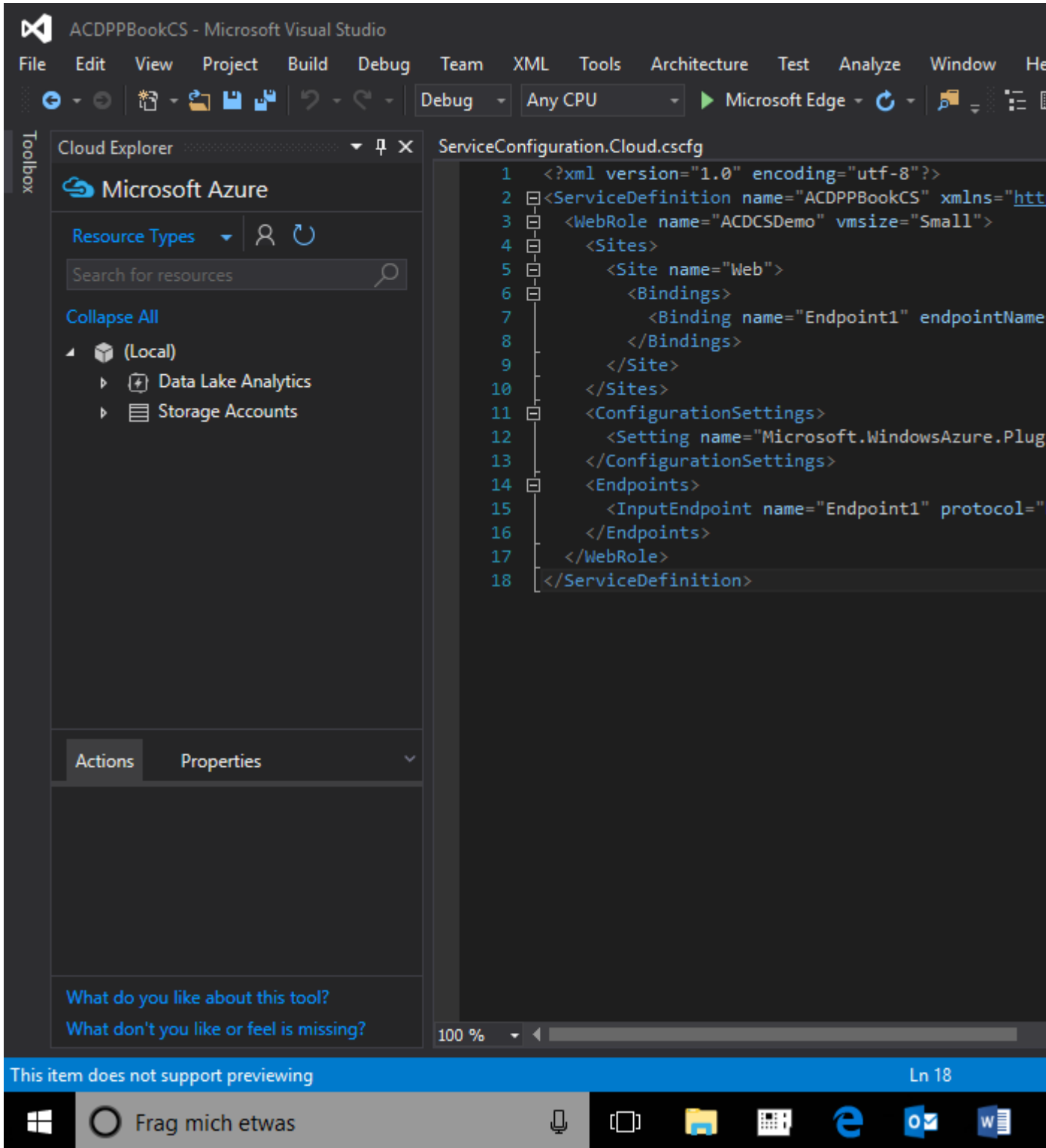

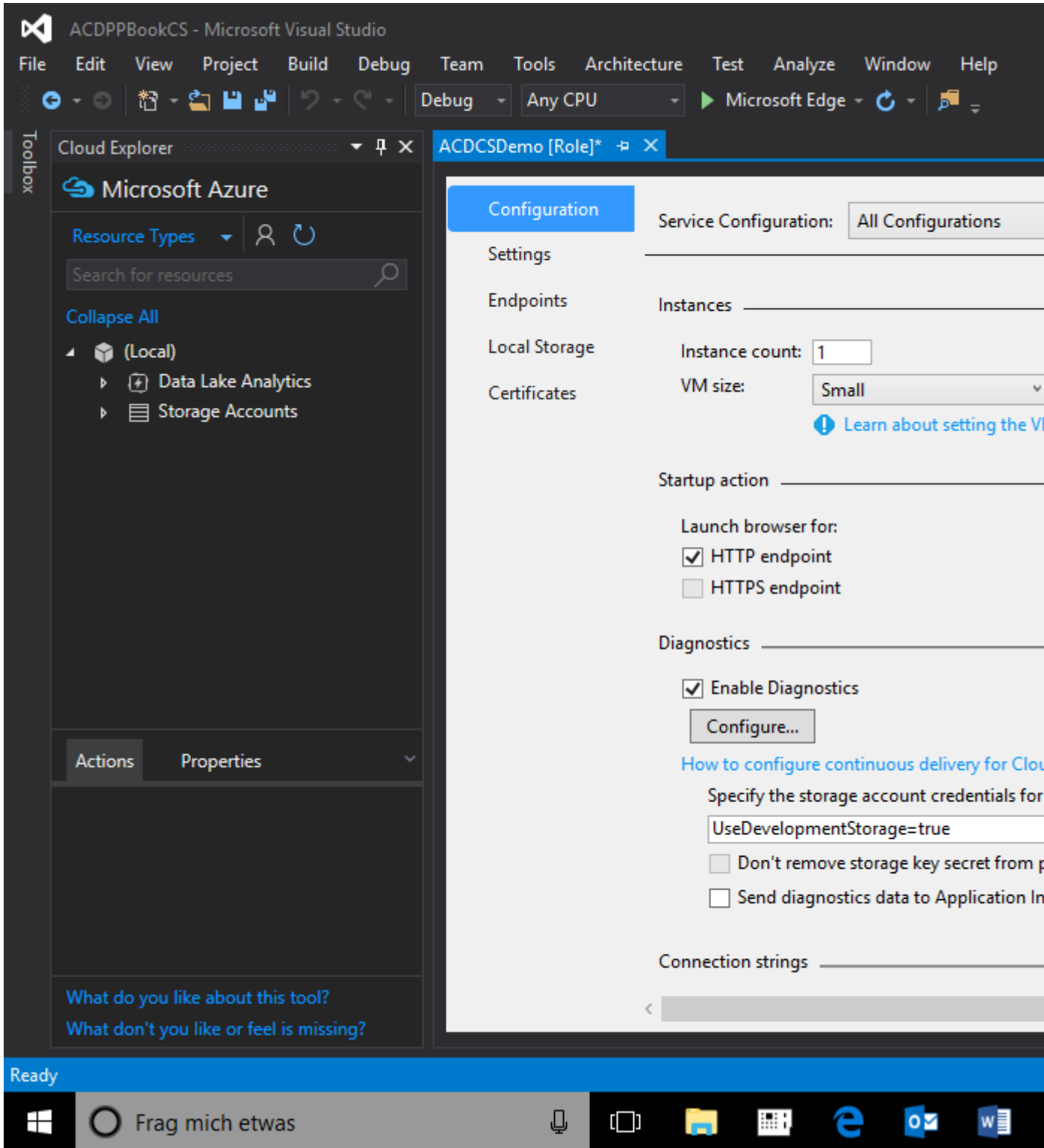

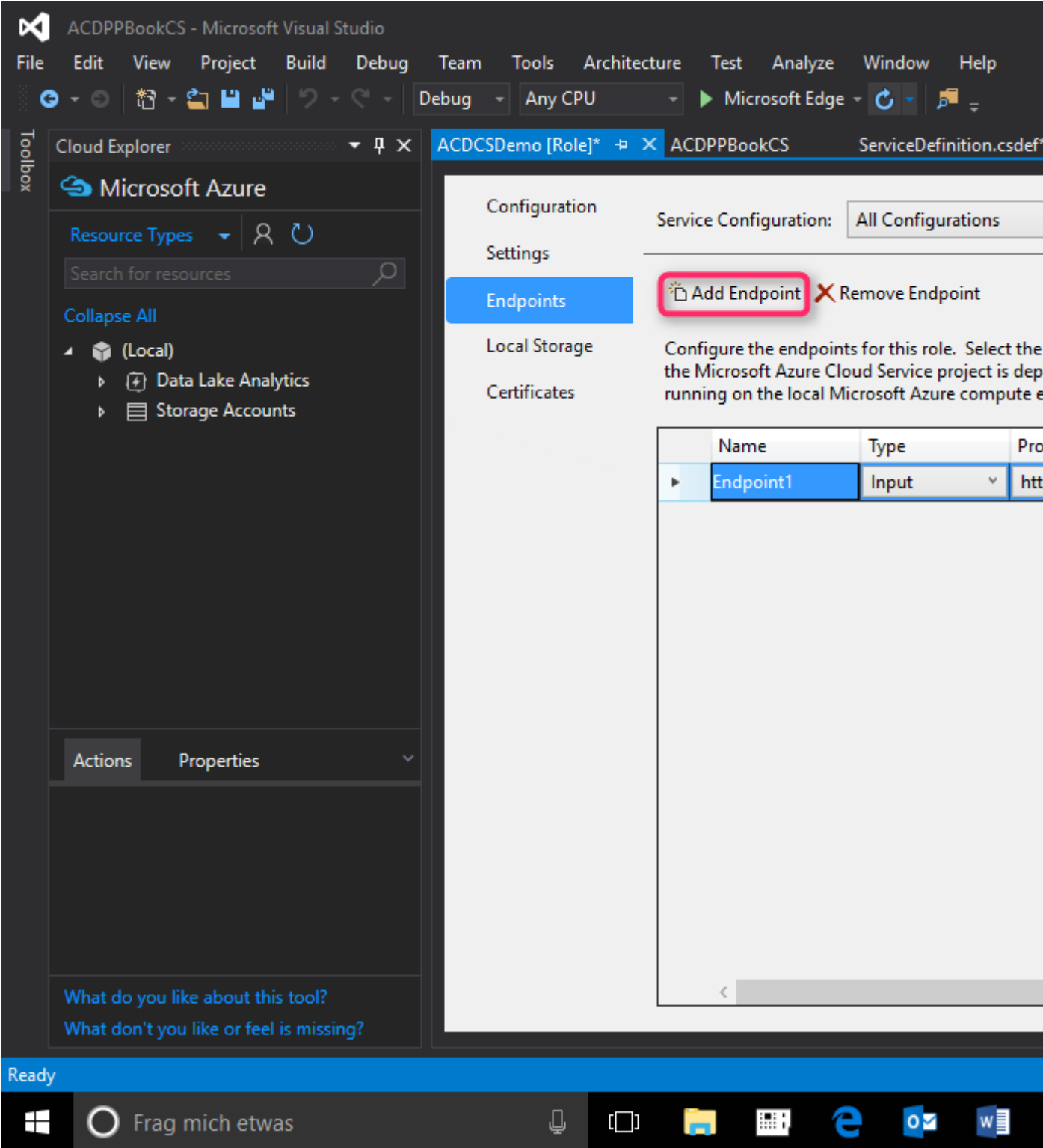

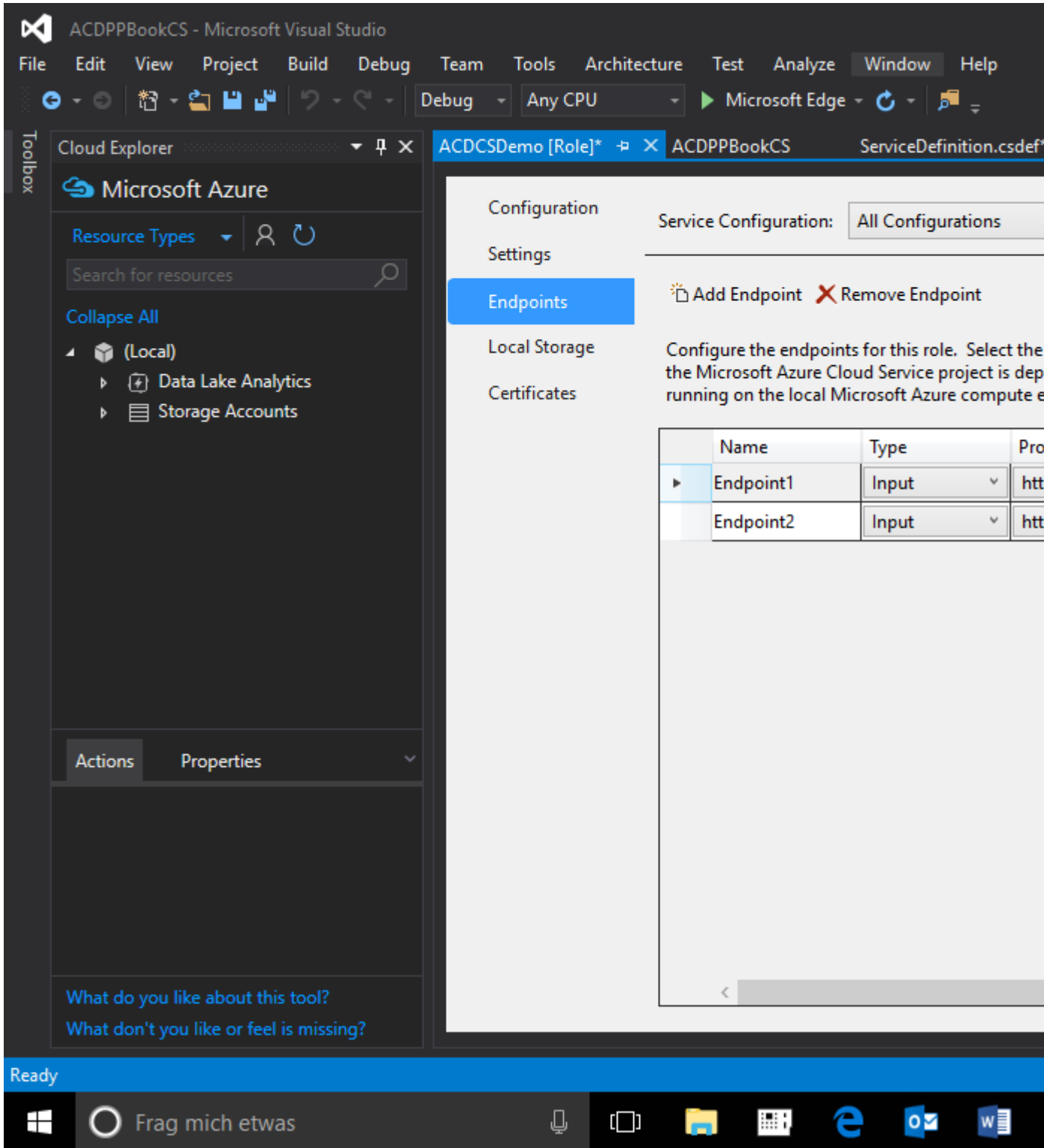

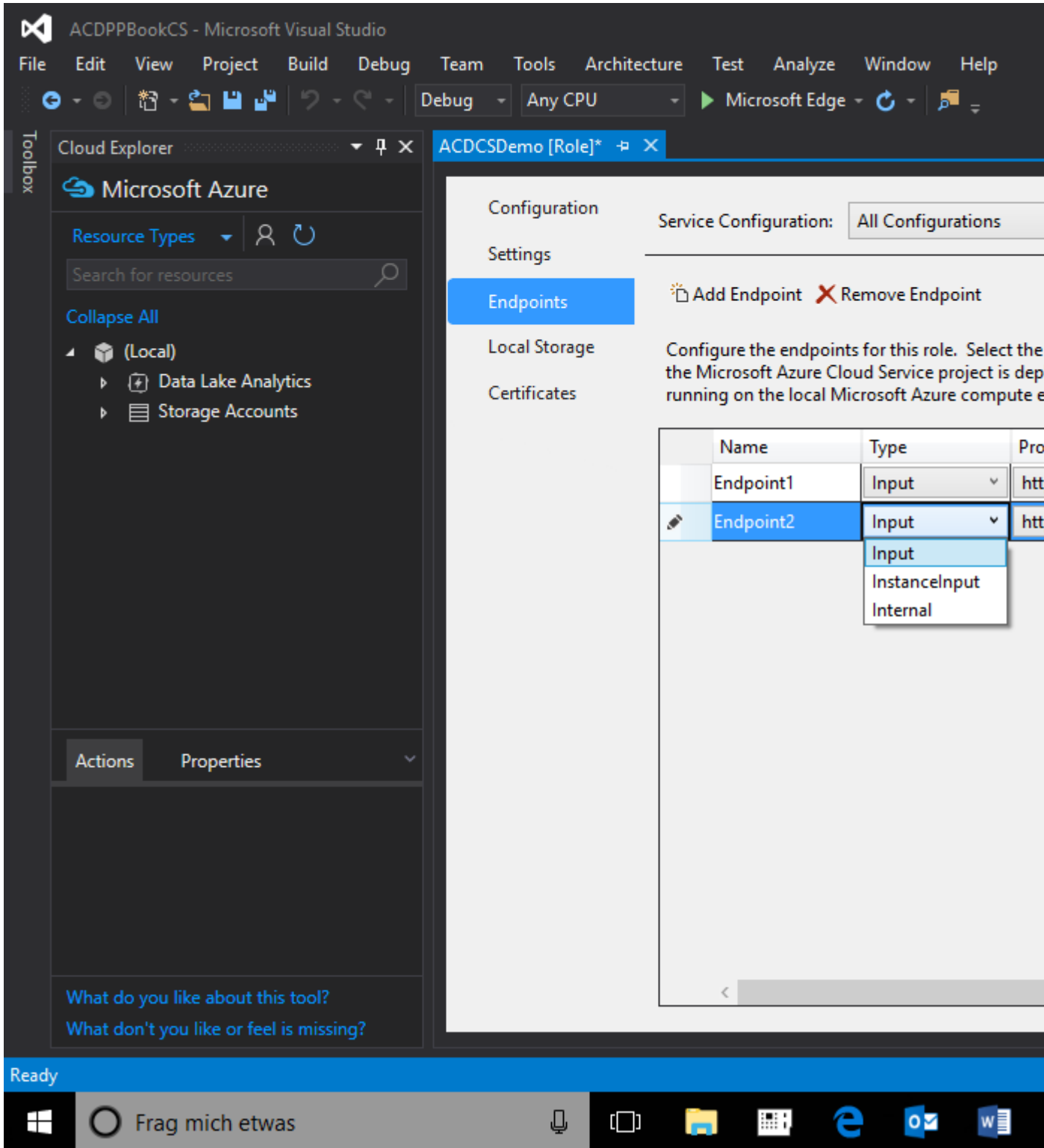

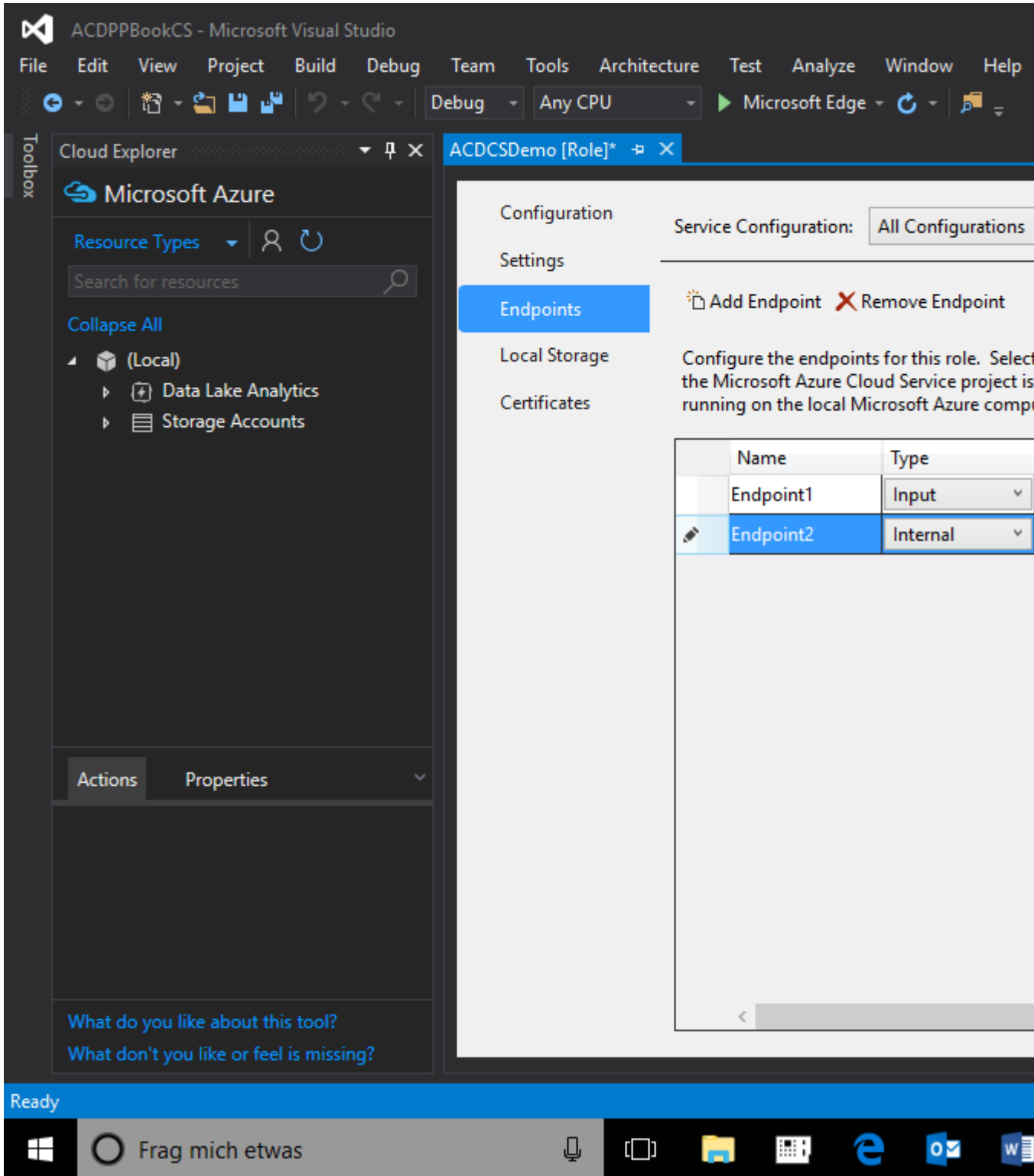

Toolbox

Cloud Explorer

Microsoft Azure

Resource Types

Search for resources

Collapse All

- (Local)
 - Data Lake Analytics
 - Storage Accounts

Actions Properties

What do you like about this tool?
What don't you like or feel is missing?

ACDCSDemo [Role]*

Configuration Service Configuration: All Configurations

Settings

Endpoints

Local Storage

Certificates

Configure the endpoints for this role. Select the the Microsoft Azure Cloud Service project is depl running on the local Microsoft Azure compute e

| Name | Type | Pro |
|-----------|-------|-----|
| Endpoint1 | Input | htt |
| Endpoint2 | Input | htt |
| | | htt |
| | | htt |
| | | tcp |
| | | udp |

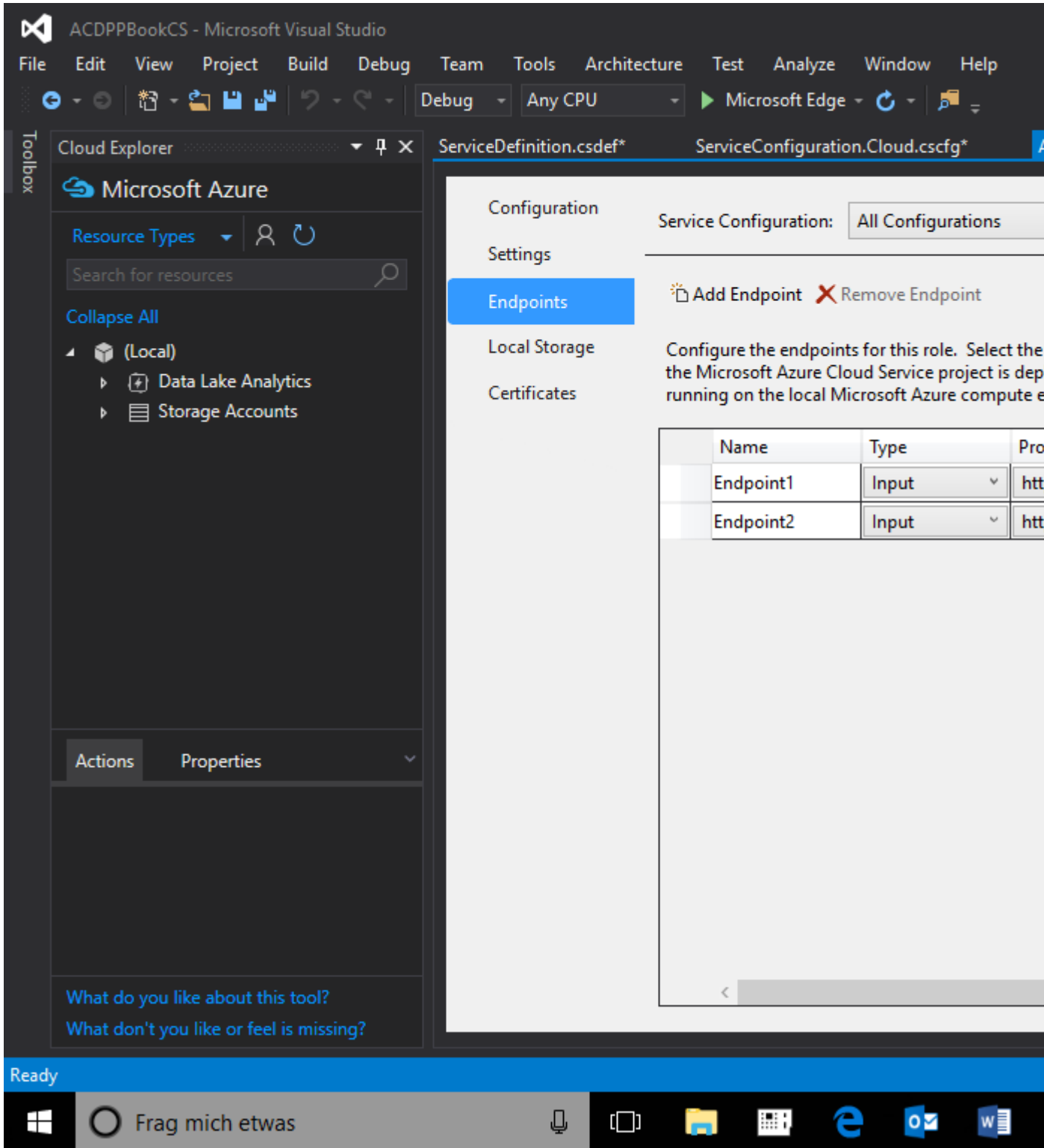

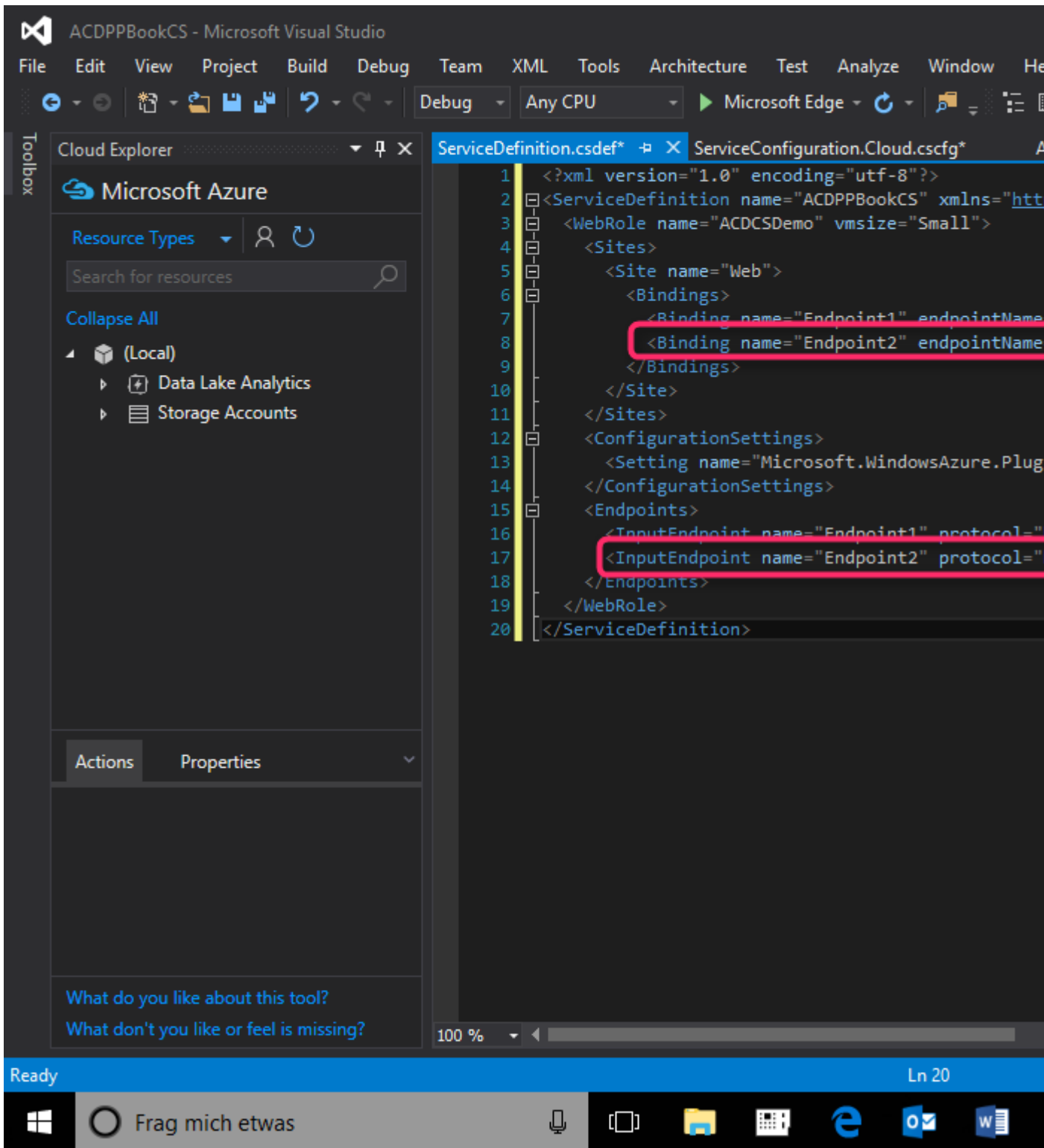

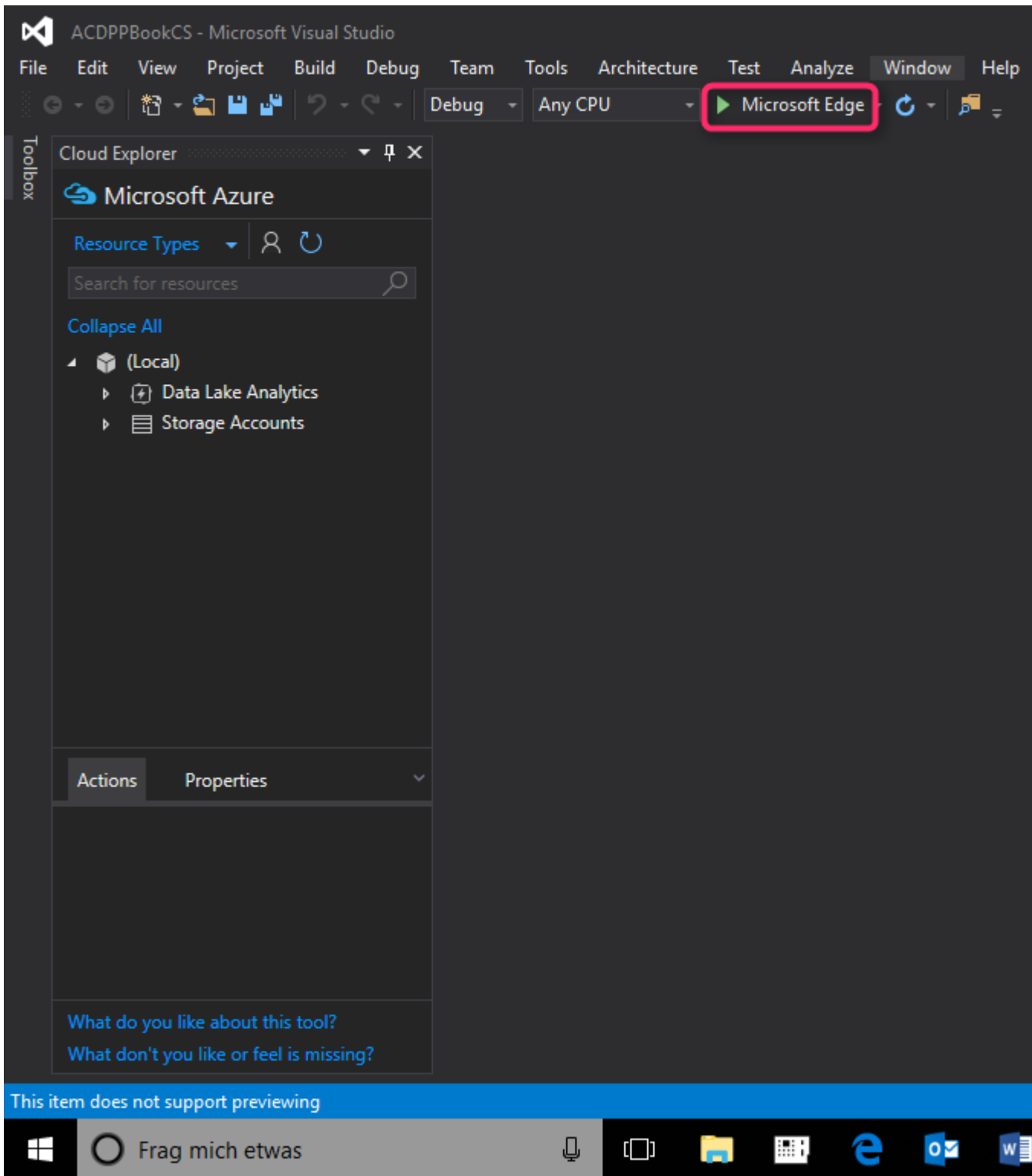

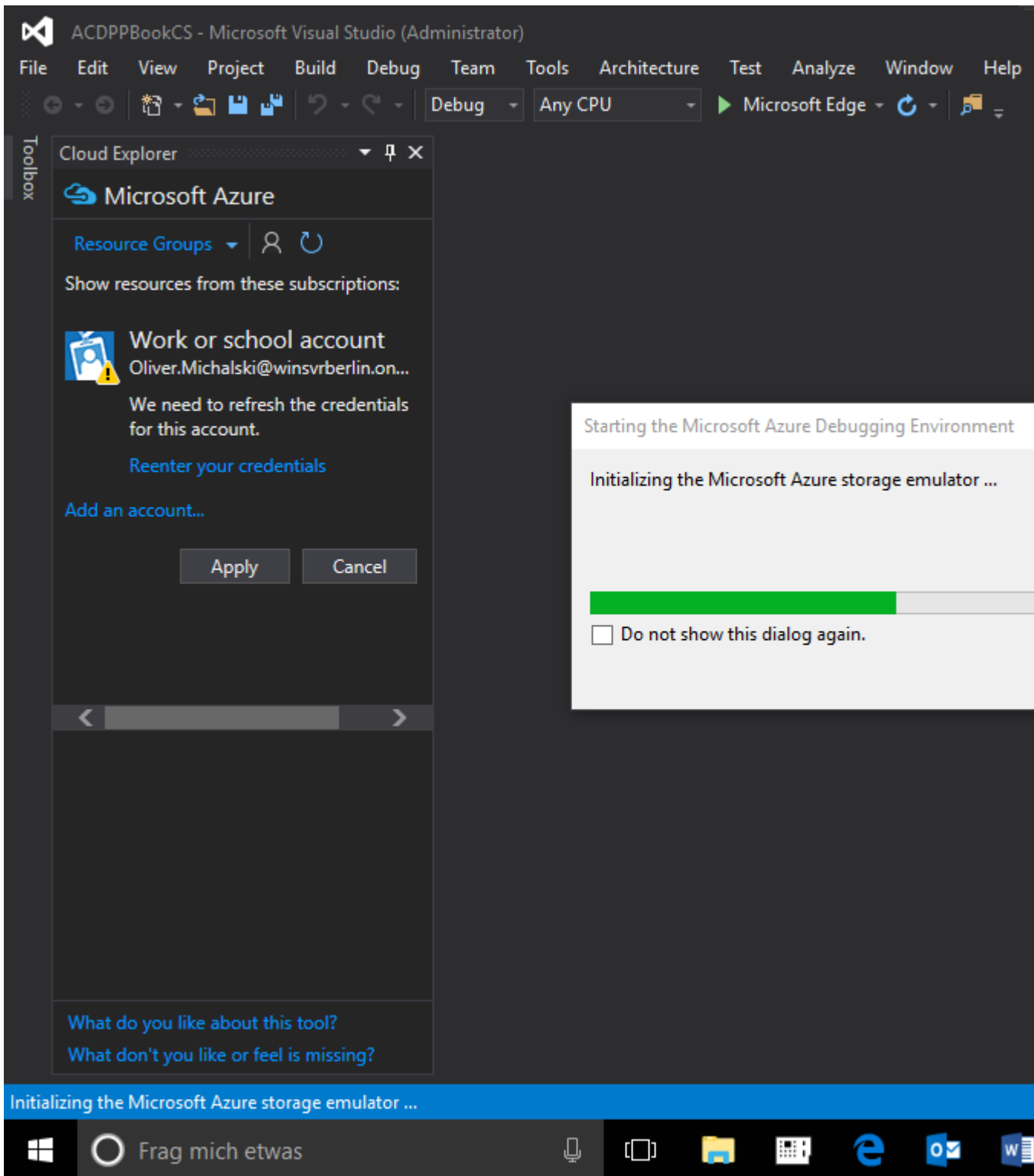

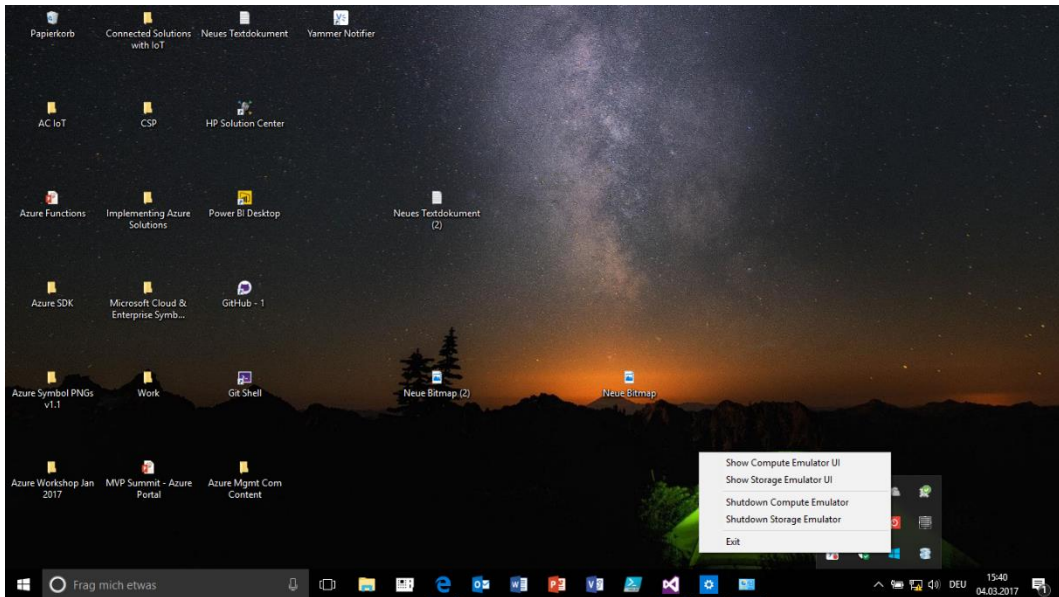
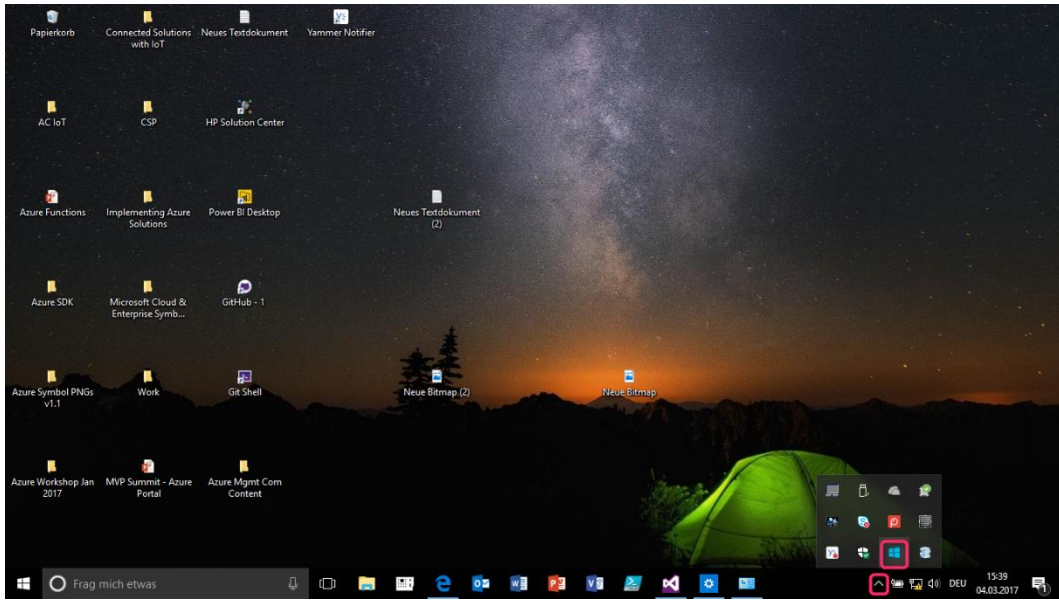

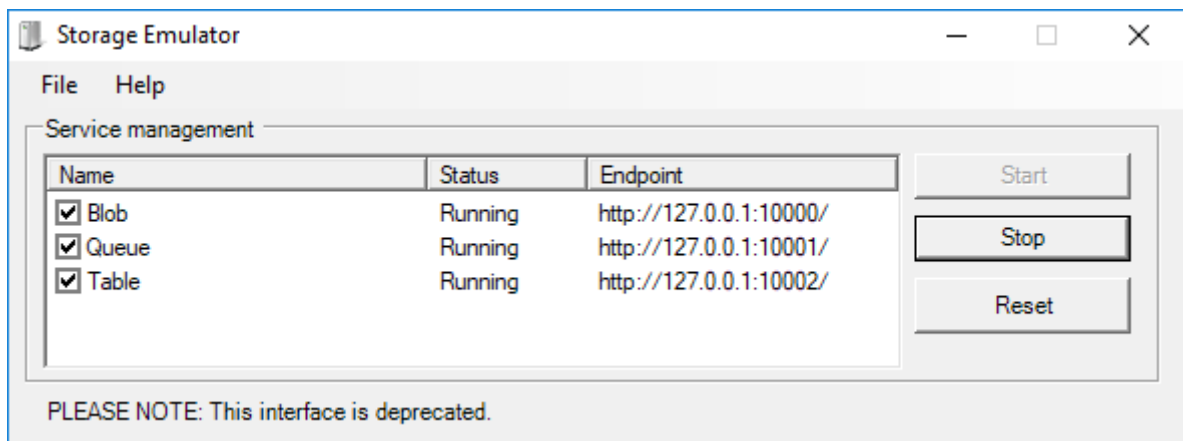
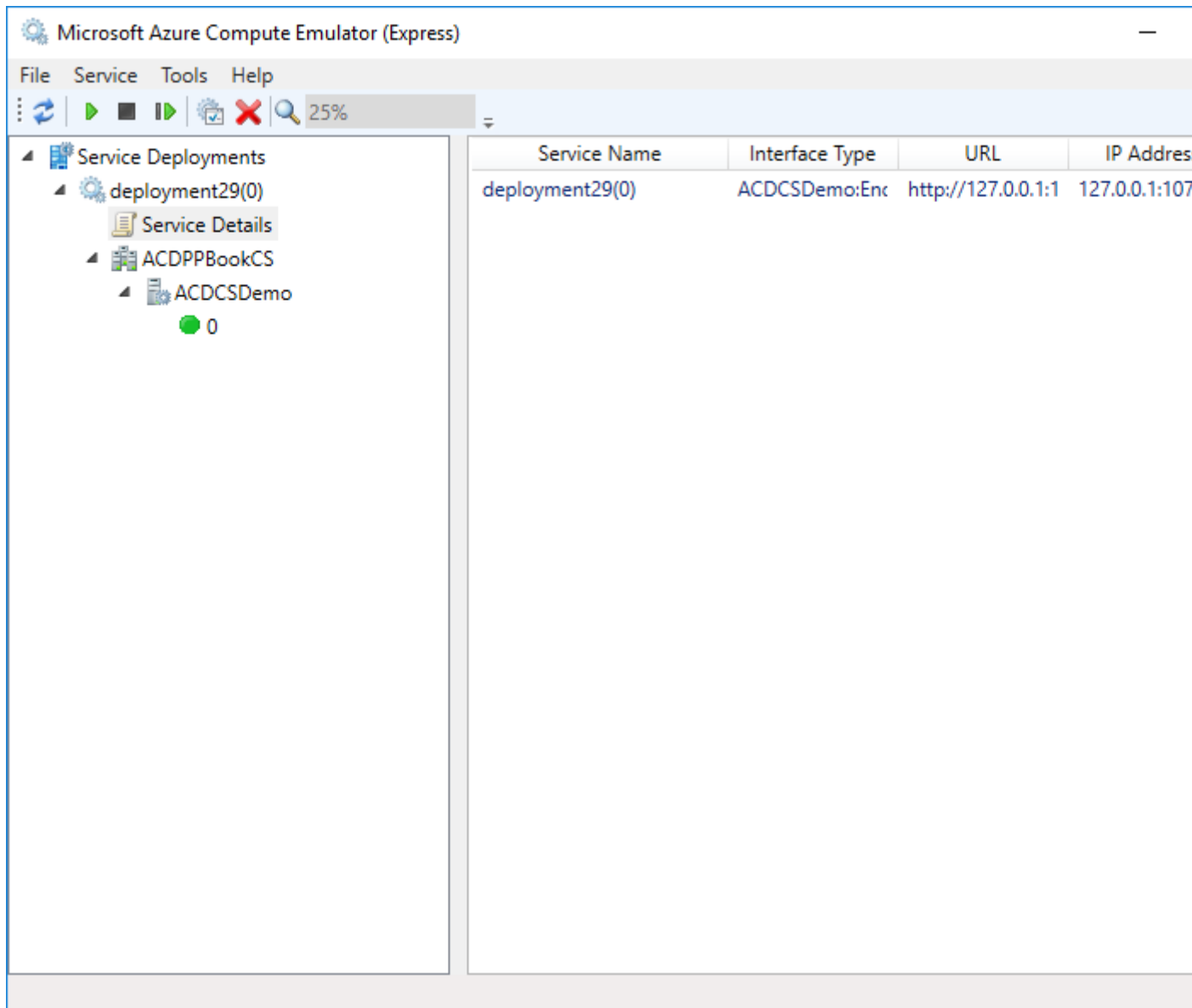

ASP.NET

ASP.NET is a free web framework for building great Web JavaScript.

[Learn more »](#)

Getting started

ASP.NET MVC gives you a powerful, patterns-based way to build dynamic websites that enables a clean separation of concerns and gives you full control over markup for enjoyable, agile development.

[Learn more »](#)

Get more libraries

NuGet is a free Visual Studio extension that makes it easy to add, remove, and update dependencies in your Visual Studio projects.

[Learn more »](#)

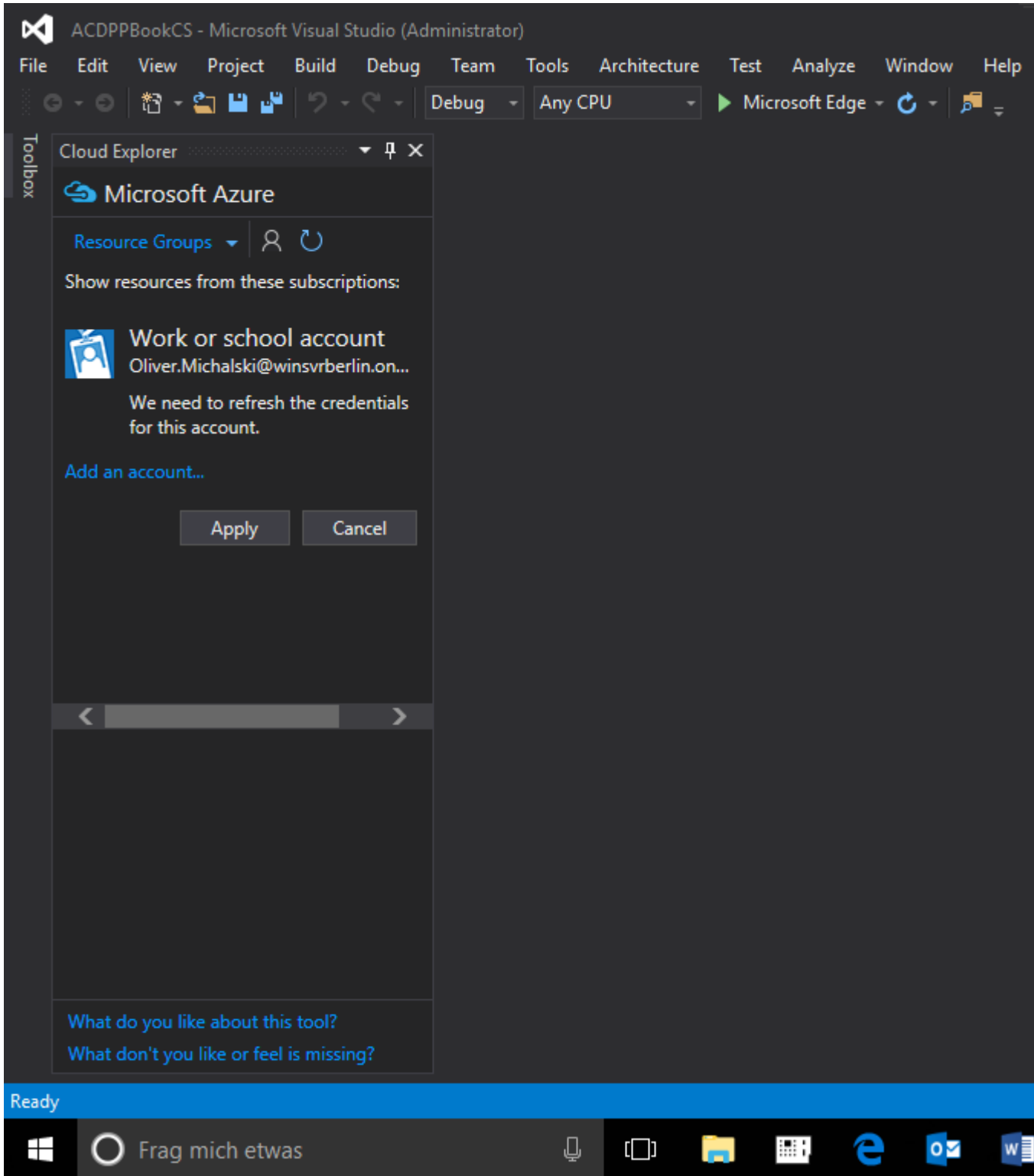



Microsoft Azure Publish Sign In

Sign in

Settings

Diagnostics

Summary

 Microsoft account
oliver-michalski@t-online.de

Choose your subscription:

Microsoft Azure Sponsorship

[Online privacy statement](#)

< Previous

Next >

Publish

Cancel



Microsoft Azure Publish Settings

Sign in

Settings

Diagnostics

Summary

Common Settings | Advanced Settings

Cloud Service:

acdppbookcs2 (West Europe)

Environment:

Staging

Build configuration:

Release

Service configuration:

Cloud

Enable Remote Desktop for all roles [Settings...](#)

Enable Web Deploy for all web roles (requires Remote Desktop)

[Online privacy statement](#)

< Previous

Next >

Publish

Cancel



Microsoft Azure Publish Settings

Sign in

Settings

Diagnostics

Summary

Common Settings **Advanced Settings**

Deployment label:

ACDPPBookCS

Append current date and time

Storage account:

acddemo (West Europe)

Delete deployment on failure

Deployment update [Settings...](#)

Enable IntelliTrace [Settings...](#)

Enable profiling [Settings...](#)

Enable Remote Debugger for all roles

[Online privacy statement](#)

< Previous

Next >

Publish

Cancel



Diagnostics Settings

Sign in

Settings

Diagnostics

Summary

Send diagnostics data to Application Insights

Sending diagnostics data to Application Insights will enable you to easily diagnose issues with your Cloud Service like role startup error and recycling.

Enabling this option will update the diagnostics configuration (diagnostics.wadcfgx) for all roles to send diagnostics errors to Application Insights. You can make further updates to the diagnostics configuration from the Role designer. This option will not install the Application Insights SDK to your project.

[Learn more about Application Insights](#)

Send telemetry to:

ACDPPBookCS (New resource) ▼



[Configure settings...](#)

[Online privacy statement](#)

< Previous

Next >

Publish

Cancel



Microsoft Azure Publish Summary

- Sign in
- Settings
- Diagnostics
- Summary**

Target profile:

| | |
|--------------------------------------|-----------------------------------|
| Deployment update: | Enabled |
| Subscription: | Microsoft Azure Sponsorship |
| Cloud Service: | acdppbookcs2 (West Europe) |
| Environment: | Staging |
| Build configuration: | Release |
| Service configuration: | Cloud |
| Remote Desktop: | Disabled |
| Web Deploy: | Disabled |
| Deployment label: | ACDPPBookCS - 10.05.2017 12:38:20 |
| Storage account: | acddemo (West Europe) |
| Delete deployment on failure: | Disabled |
| IntelliTrace: | Disabled |

[Online privacy statement](#)

< Previous

Next >

Publish

Cancel

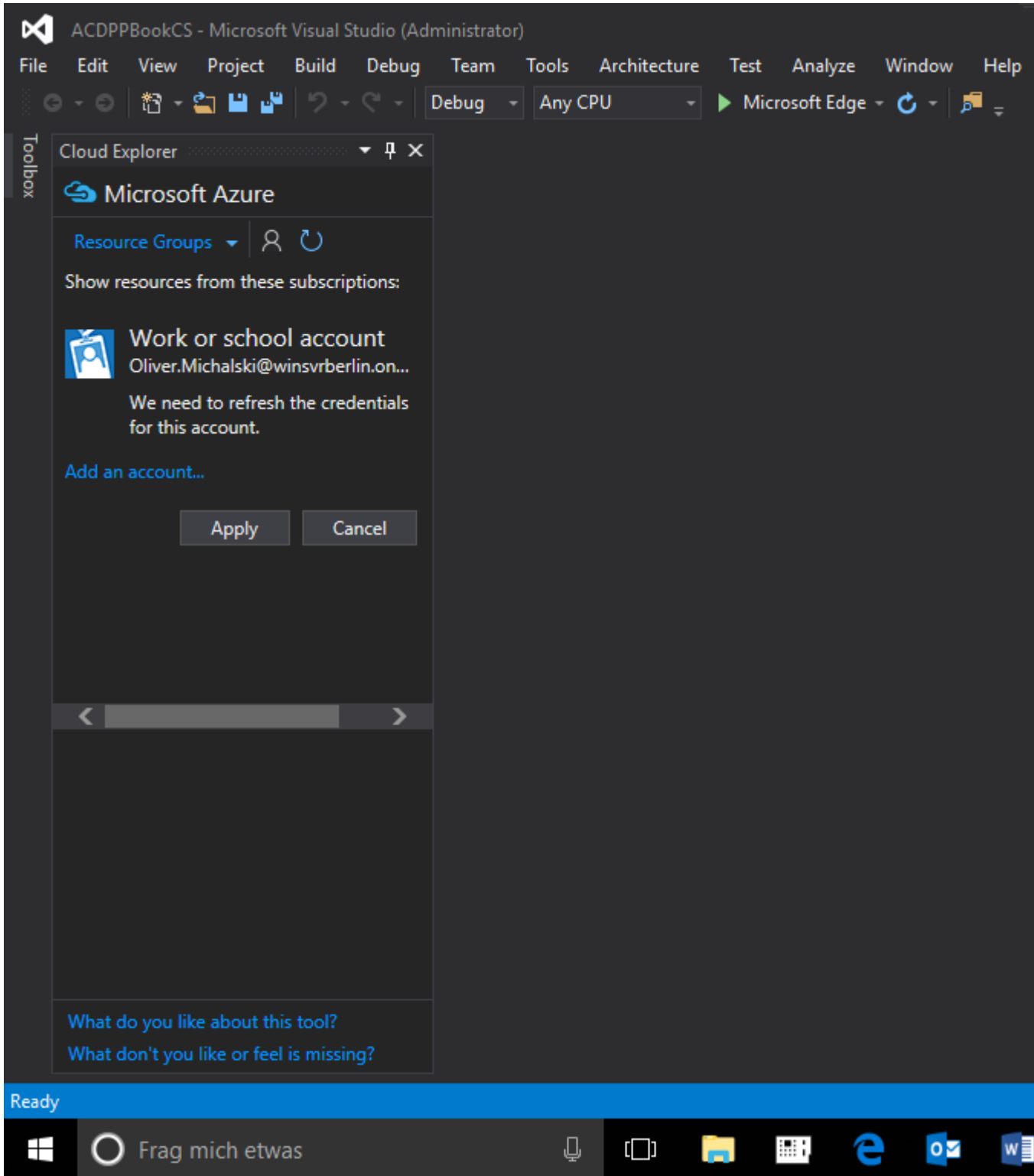

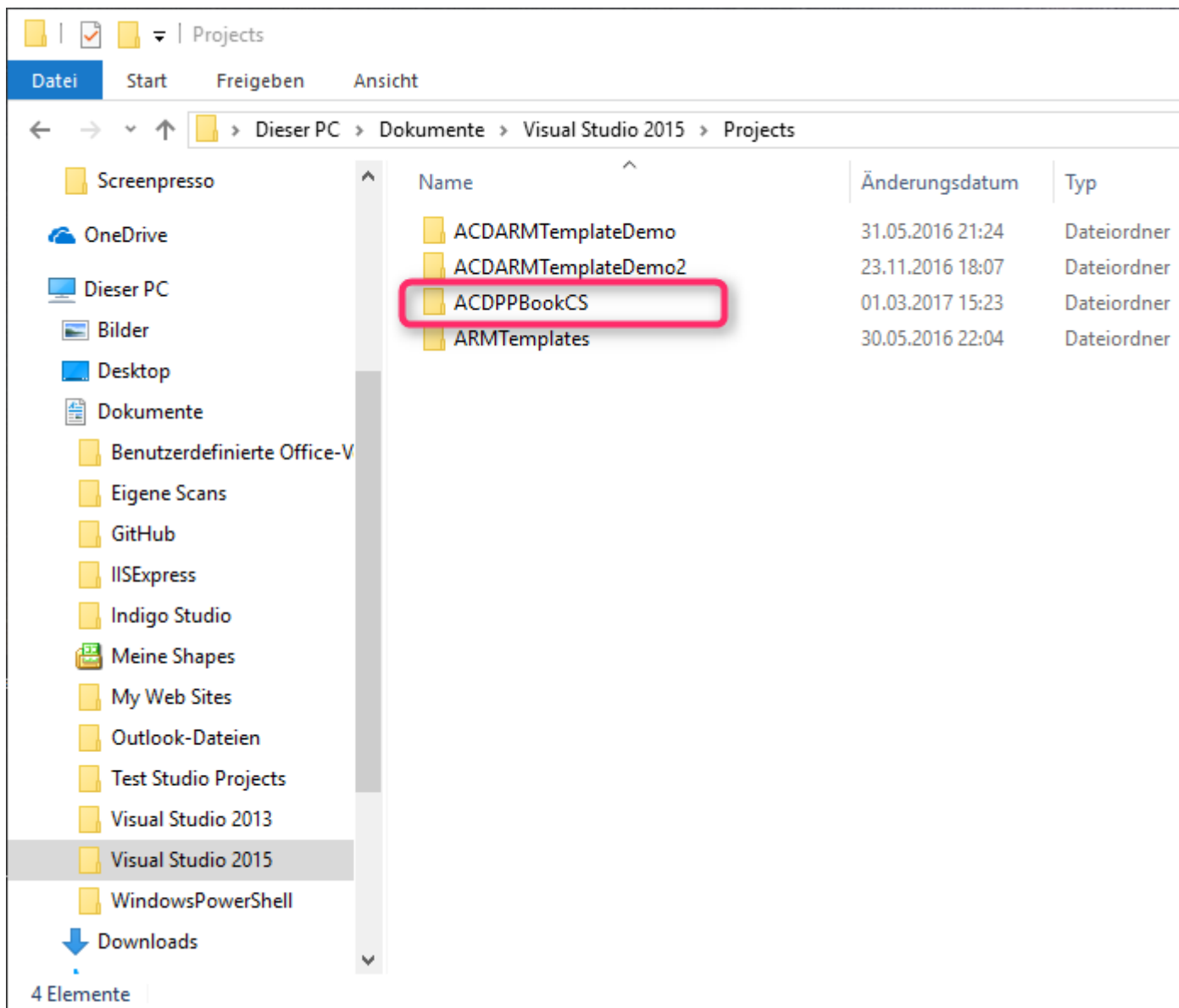
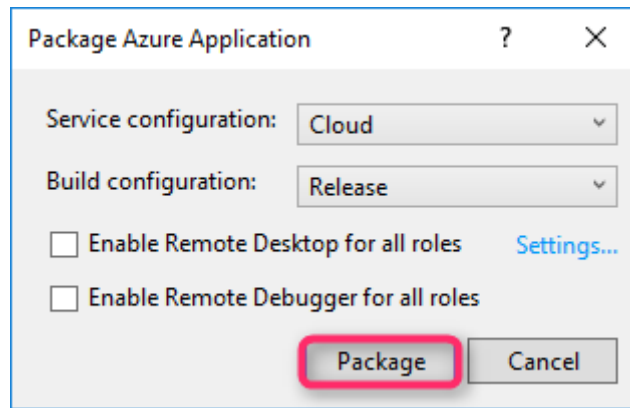

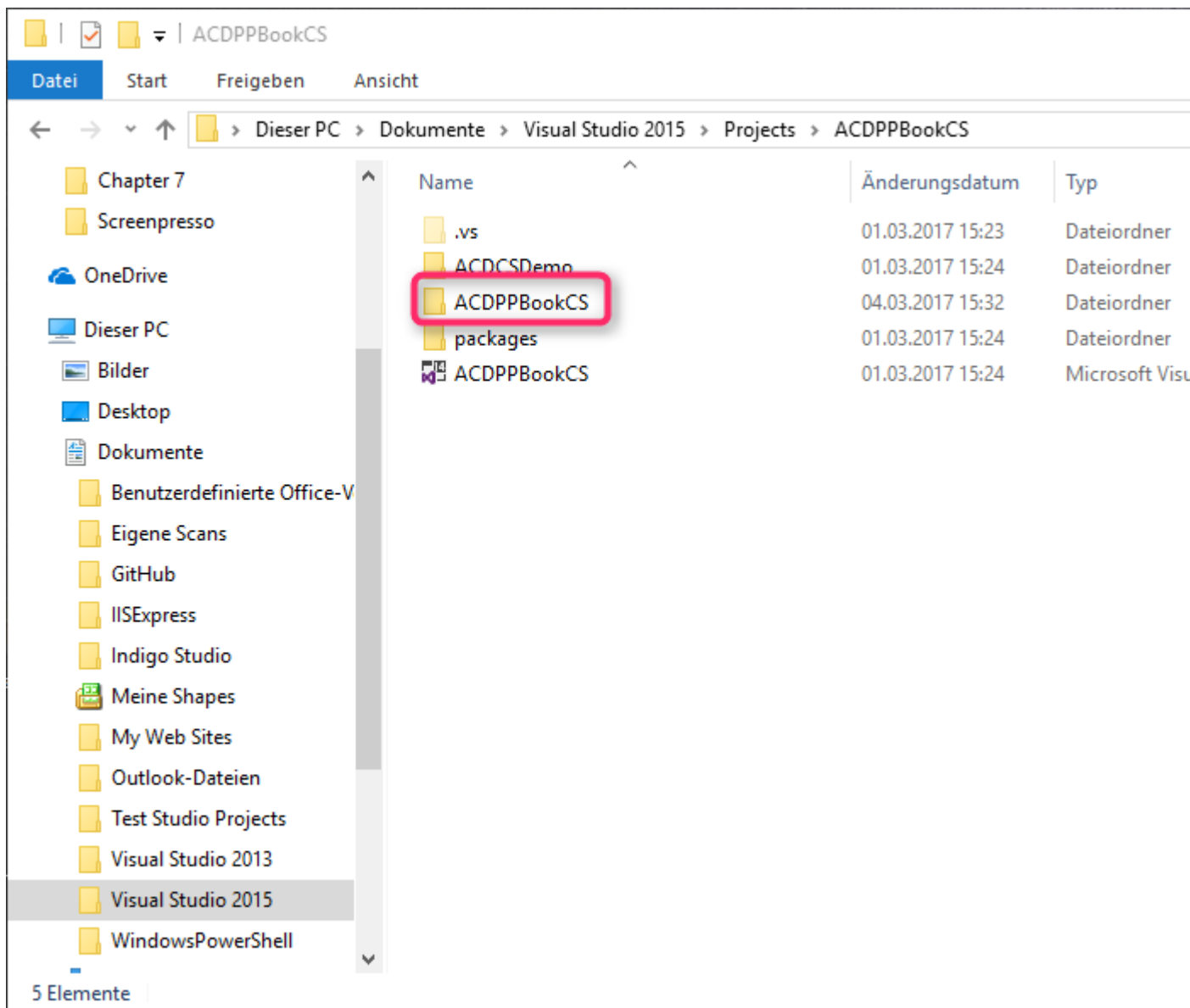

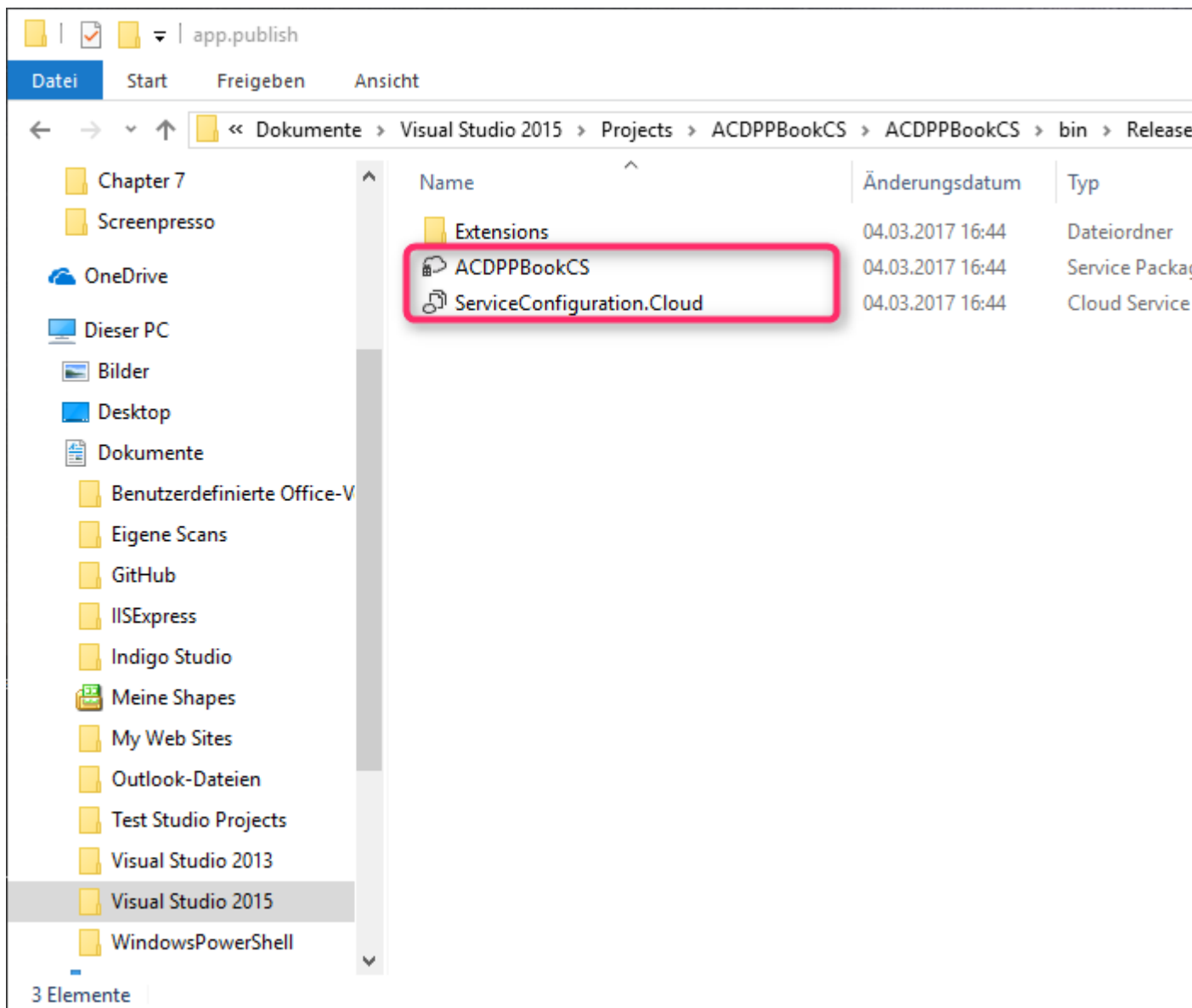



acdppbookcs - Staging

Cloud service (classic)

Search (Ctrl+/)

- Overview
- Activity log
- Access control (IAM)
- Diagnose and solve problems
- SETTINGS
 - Antimalware
 - Certificates
 - Configuration
 - Extensions
 - Instances
 - Remote Desktop
 - Scale

Staging slot **Upload** Start Swap

No deployment

Essentials

Resource group (change)
acdppbook
Status
-
Location
North Europe
Subscription name (change)
Visual Studio Enterprise
Subscription ID
02f13438-c22f-4f1b-ad33-0f9f2eef0ba6

Roles and instances

| NAME | STATUS | S |
|------|--------|---|
|------|--------|---|

You have nothing deployed to the current environment.



Upload a package

acdppbookcs - Staging



This will create a new 'Staging' deployment

* Storage account ⓘ
Configure required settings

* Deployment label
Enter the deployment label...

Package (.cspkg, .zip)

Select a file

Configuration (.cscfg)

Select a file

Deploy even if one or more roles contain a single instance ⓘ

Start deployment ⓘ

OK

Choose storage account

Refresh

Subscription Visual Studio Enterprise

Location: North Europe SKU: Not Premium_LRS Kind:

Search storage accounts

| NAME | TYPE |
|---------------|---------------|
| acddevstor | Standard-LRS |
| acdilot | Standard-LRS |
| acdppbookstor | Standard-RAGR |



Upload a package

acdppbookcs - Staging

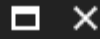

This will create a new 'Staging' deployment



* Storage account ⓘ

acdppbookstor



* Deployment label

acdtest



Package (.cspkg, .zip)

Select a file



Configuration (.cscfg)

Select a file



Deploy even if one or more roles contain a single instance ⓘ



Start deployment ⓘ



OK





Upload a package

acdppbookcs - Staging

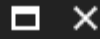

This will create a new 'Staging' deployment



* Storage account ⓘ

acdppbookstor



* Deployment label

acdtest



Package (.cspkg, .zip)

ACDPPBookCS.cspkg



ACDPPBookCS.cspkg



Configuration (.cscfg)

Select a file



Deploy even if one or more roles contain a single instance ⓘ



Start deployment ⓘ



OK





Upload a package

acdppbookcs - Staging

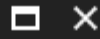

This will create a new 'Staging' deployment

* Storage account ⓘ

acdppbookstor

* Deployment label

acdtest ✓

Package (.cspkg, .zip)

ACDPPBookCS.cspkg ✓

ACDPPBookCS.cspkg

Configuration (.cscfg)

ServiceConfiguration.Cloud.cscfg ✓

ServiceConfiguration.Cloud.cscfg

Deploy even if one or more roles contain a single instance ⓘ

Start deployment ⓘ

OK



Upload a package

acdppbookcs - Staging

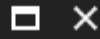

This will create a new 'Staging' deployment

* Storage account ⓘ

acdppbookstor

* Deployment label

acctest

Package (.cspkg, .zip)

ACDPPBookCS.cspkg

ACDPPBookCS.cspkg

Configuration (.cscfg)

ServiceConfiguration.Cloud.cscfg

ServiceConfiguration.Cloud.cscfg

Deploy even if one or more roles contain a single instance ⓘ

Start deployment ⓘ

OK

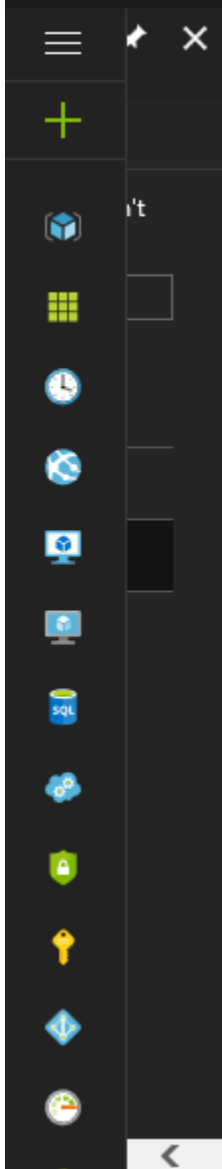

acdppbookcs - Staging
Cloud service (classic)

Search (Ctrl+/)

- Overview
- Activity log
- Access control (IAM)
- Diagnose and solve problems

SETTINGS

- Antimalware
- Certificates
- Configuration
- Extensions
- Instances
- Remote Desktop
- Scale

Staging slot Update Stop Swap

Running (1 instance: 1 Starting VM) →

Essentials ^

Resource group (change)
acdppbook

Status
Running

Location
North Europe

Subscription name (change)
Visual Studio Enterprise

Subscription ID
02f13438-c22f-4f1b-ad33-0f9f2eef0ba6

Roles and instances

| NAME | STATUS |
|----------------|-------------|
| ▼ ACDCSDemo | |
| ACDCSDemo_IN_0 | Starting VM |

Chapter 8: Implementing Azure Container Service

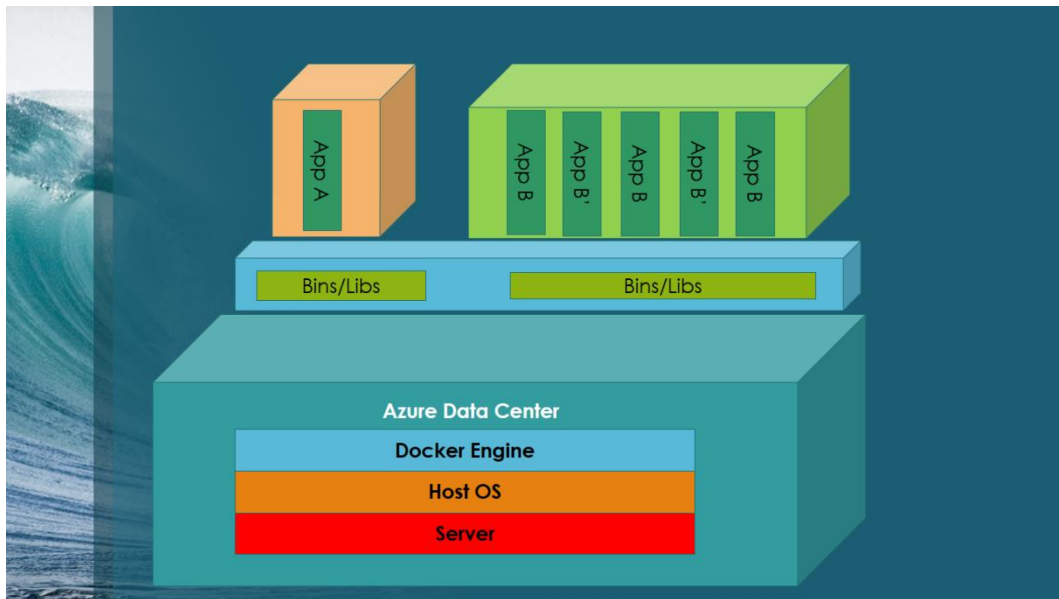
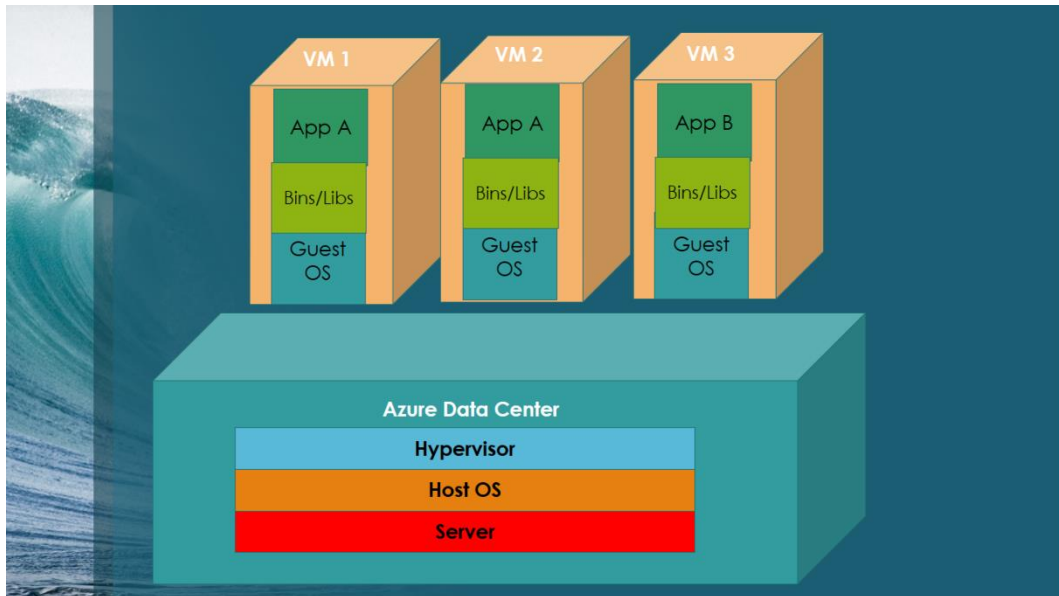

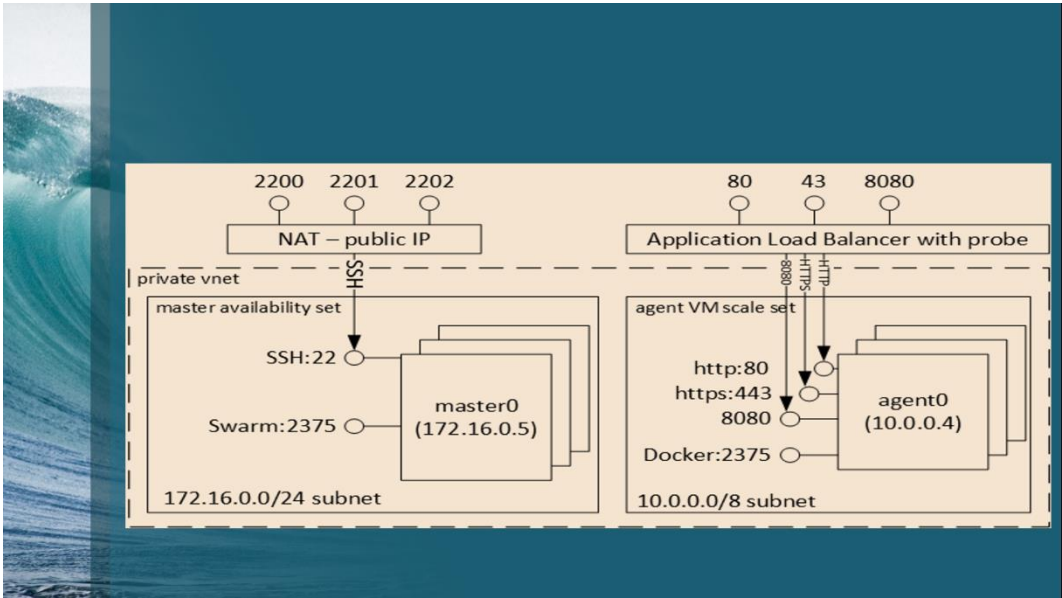
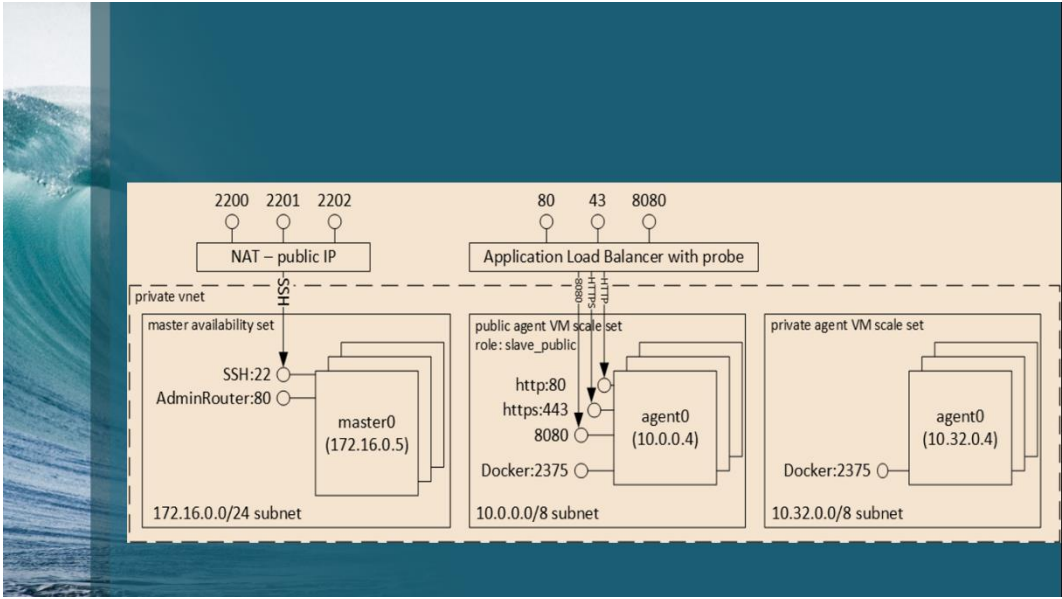

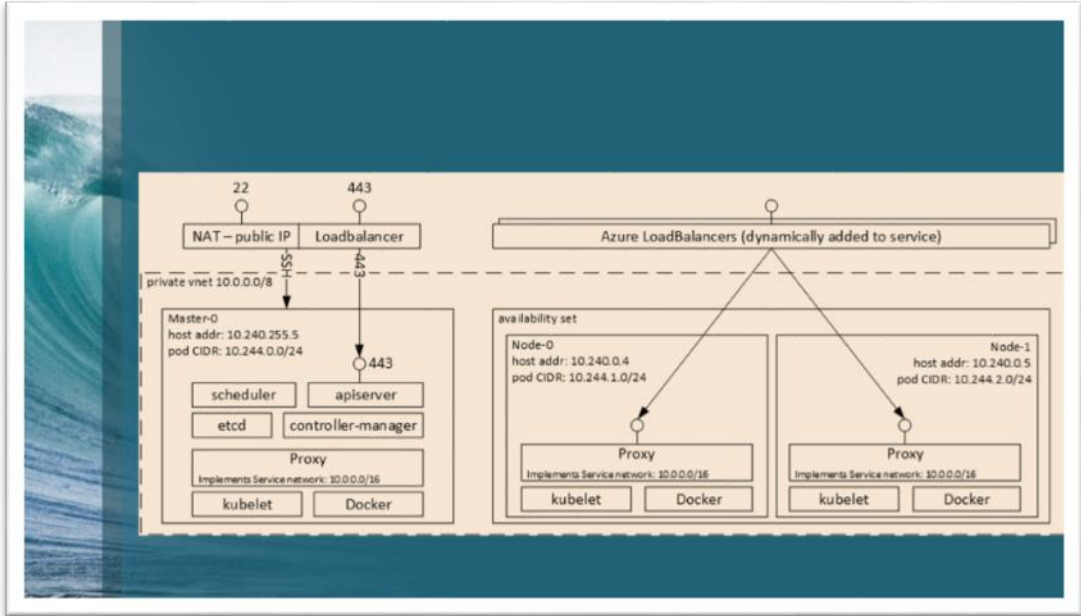



New

- Resource groups
- All resources
- Recent
- App Services
- Virtual machines (classic)
- Virtual machines
- SQL databases
- Cloud services (classic)
- Security Center
- Subscriptions
- Azure Active Directory
- Monitor
- Billing
- Help + support

Dashboard

+ New dashboard

Edit dashboard

Share

- All resources
ALL SUBSCRIPTIONS
- acdppbookstor
 - acdeventhubdev-ns
 - acdmlwsp
 - acdcsiotdemo
 - Dtlacdtestlab
 - acdiotthdev
 - acdappservplan
 - acddemoportal
 - acddemoportal

Service health MY RESOURCES

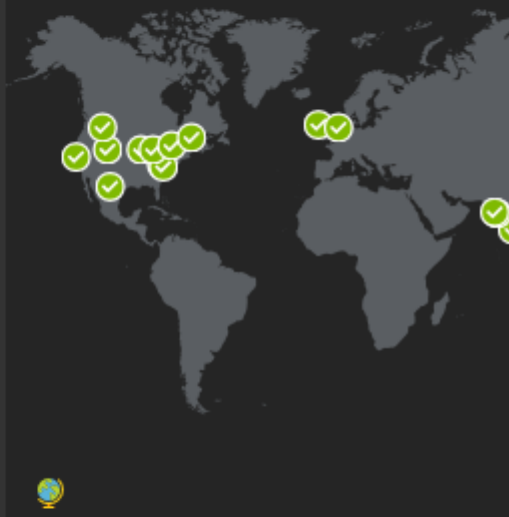







New □ ×

 *Search the marketplace*

MARKETPLACE See all

- Compute** >
- Networking >
- Storage >
- Web + Mobile >
- Databases >
- Intelligence + analytics >
- Internet of Things >
- Enterprise Integration >
- Security + Identity >
- Developer tools >
- Monitoring + Management >
- Add-ons >

Compute □ ×

-  value scale-out performance available.
-  **SQL Server 2016 SP1 Enterprise on Windows Server 2016**
Enterprise version of SQL Server 2016 SP1 for transactional, data
-  **Virtual machine scale set**
Deploy multiple instances of a single image.
-  **Azure Container Service**
A pre-configured environment for scalable deployment and management of containerized
-  **Azure Container Registry (preview)**
PREVIEW Manage a Docker private registry as a first-class Azure resource.
-  **Function App**
Write any function in minutes – whether to run a simple job that cleans up a database or build a



New



Web + Mobile



Databases



Intelligence + analytics



Internet of Things



Enterprise Integration



Security + Identity



Developer tools



Monitoring + Management



Add-ons



Containers



Blockchain



RECENT



SQL Database
Microsoft



Containers



FEATURED APPS

[See all](#)



Azure Container Service
A pre-configured environment for scalable deployment and management of containerized

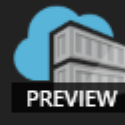

Azure Container Registry (preview)
Manage a Docker private registry as a first-class Azure resource.



Docker EE for Azure (Standard/Advanced)
Docker EE for Azure is an integrated platform to build, ship and run

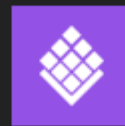

DC/OS on Azure
DC/OS is a production proven solution to run containers and Big Data workloads.



RancherOS
RancherOS is a 20mb Linux Distro that Runs Docker as Pid1 and all services as custom containers



+ New

Virtual machines (classic)

Virtual machines

SQL databases

Cloud services (classic)

Security Center

Subscriptions

Azure Active Directory

Monitor

Billing

Help + support

Azure Advisor

More services >



Azure Container Service

Microsoft

Azure Container Service (ACS) provides a way to simplify the creation, configuration, management of a cluster of virtual machines that are preconfigured to run container applications. Using an optimized configuration of popular open-source scheduling tools, ACS enables you to use your existing skills or draw upon a large and growing community expertise to deploy and manage container-based applications on Microsoft Azure.

ACS leverages Docker images to ensure that your application containers are fully portable. It supports your choice of DC/OS (powered by Apache Mesos) or Docker Swarm for orchestration, and ensures that these applications can be scaled to thousands, even tens of thousands of instances.

The Azure Container service enables you to take advantage of the enterprise grade features of Docker while still maintaining application portability, including at the orchestration layers.

There are no fees for any of the software installed by default as part of ACS. All default components are implemented by open source software.

ACS is currently available for Standard A, D, DS, G and GS series Linux virtual machines. There are no charges for the compute instances you choose, as well as the other underlying infrastructure resources consumed such as storage and networking. There are no incremental charges for the service itself.

Deployment will typically take 15-20 minutes. Once complete you can access and manage your cluster.

Select a deployment model ⓘ

Resource Manager

Create



+ New

Virtual machines (classic)

Virtual machines

SQL databases

Cloud services (classic)

Security Center

Subscriptions

Azure Active Directory

Monitor

Billing

Help + support

Azure Advisor

More services >

Create Azure Container Ser...

1 Basics
Configure basic settings

2 Master configuration
Provide master information

3 Agent configuration
Provide agent information

4 Summary
Azure Container Service

Basics

* Orchestrator

Subscription

Visual Studio Enterpris

* Resource group

Create new

Location

North Europe

OK





+ New

Virtual machines (classic)

Virtual machines

SQL databases

Cloud services (classic)

Security Center

Subscriptions

Azure Active Directory

Monitor

Billing

Help + support

Azure Advisor

More services >

Create Azure Container Ser... ☐ ✕

1 Basics >
Configure basic settings

2 Master configuration >
Provide master information

3 Agent configuration >
Provide agent information

4 Summary >
Azure Container Service

Basics

* Orchestrator ⓘ

- DC/OS
- Kubernetes
- Swarm
- visual studio enterprise

* Resource group ⓘ

Create new

Location

North Europe

OK



+ New

Virtual machines (classic)

Virtual machines

SQL databases

Cloud services (classic)

Security Center

Subscriptions

Azure Active Directory

Monitor

Billing

Help + support

Azure Advisor

More services >

Create Azure Container Ser... ☐ ✕

1 Basics >
Configure basic settings

2 Master configuration >
Provide master information

3 Agent configuration >
Provide agent information

4 Summary >
Azure Container Service

Basics

* Orchestrator ⓘ

DC/OS

Subscription

Visual Studio Enterprise

* Resource group ⓘ

Create new

acdppbac

Location

North Europe

OK





+ New

Virtual machines (classic)

Virtual machines

SQL databases

Cloud services (classic)

Security Center

Subscriptions

Azure Active Directory

Monitor

Billing

Help + support

Azure Advisor

More services >

Create Azure Container Ser...

1 Basics 
Configure basic settings

2 Master configuration 
Provide master information

3 Agent configuration 
Provide agent information

4 Summary 
Azure Container Service

Basics

* Orchestrator 

DC/OS

Subscription

Visual Studio Enterprise

* Resource group 

Create new

acdppbac

Location

North Europe

OK





+ New

Virtual machines (classic)

Virtual machines

SQL databases

Cloud services (classic)

Security Center

Subscriptions

Azure Active Directory

Monitor

Billing

Help + support

Azure Advisor

More services >

Create Azure Container Ser... □ ×

1 Basics >
Configure basic settings

2 Master configuration >
Provide master information

3 Agent configuration >
Provide agent information

4 Summary >
Azure Container Service

Basics

* Orchestrator ⓘ

DC/OS

Subscription

Visual Studio Enterprise

* Resource group ⓘ

Create new

acdppbac

Location

North Europe

OK





+ New

Virtual machines (classic)

Virtual machines

SQL databases

Cloud services (classic)

Security Center

Subscriptions

Azure Active Directory

Monitor

Billing

Help + support

Azure Advisor

More services >

Create Azure Container Ser... ☐ ✕

1 Basics Done ✓

2 Master configuration >
Provide master information

3 Agent configuration >
Provide agent information

4 Summary >
Azure Container Service

Master configura

* DNS name prefix ⓘ

Master credentials

* User name ⓘ

* SSH public key ⓘ

Settings

Master count ⓘ

1

VM diagnostics ⓘ

Disabled Enabled

OK



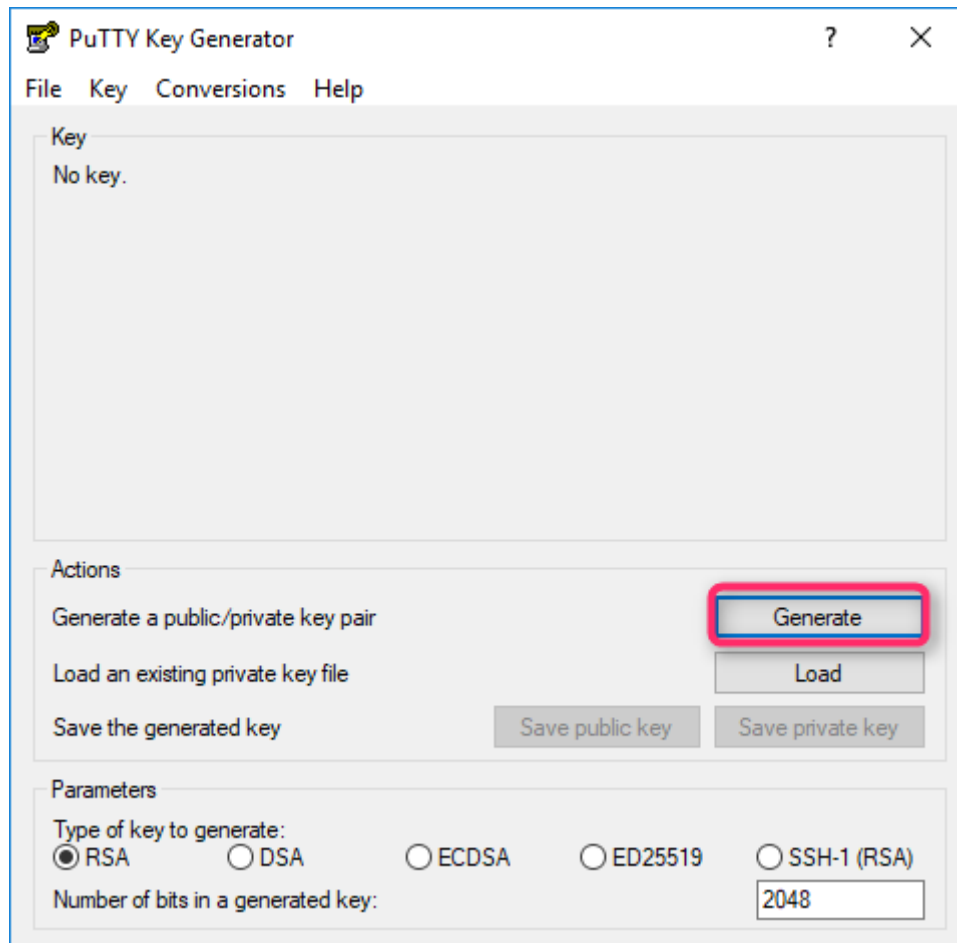

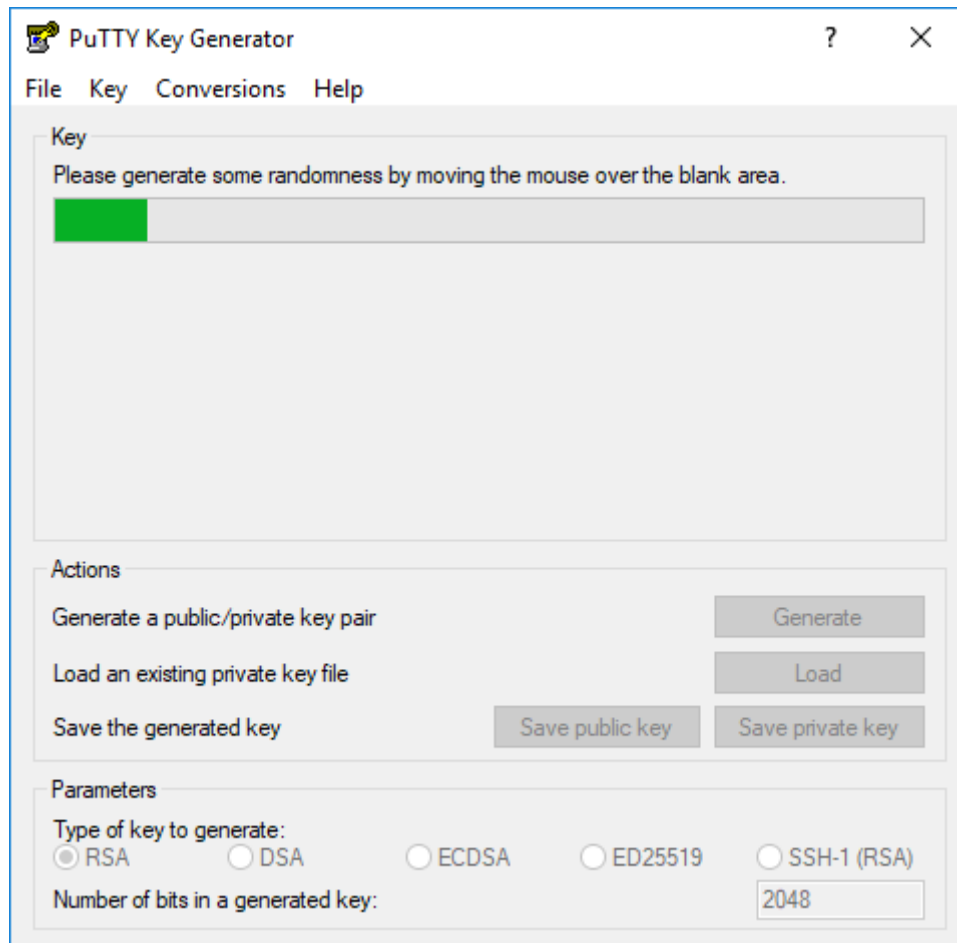

PuTTY Key Generator

File Key Conversions Help

Key

Public key for pasting into OpenSSH authorized_keys file:

```
ssh-rsa AAAAB3NzaC1yc2EAAAABJQAAQEAqkRkUM0Jv+E7DwoQ
+YMesl8/jzuz9zBaLZwZRcYfaabGw/S7k9qyXo7AH+YUzaaMF/XnrEj4bxQ7HTT1V
+UL82I3vwraKyGmcCd4bfiPM1AL79o6p
+XFaSPpsdlwtV3KGoq94YU84P1PgkzlluUoBlalF1aXJrMYbkj4t6TRAKX1QBWmHzv
gwoQLrdIAM8TY91r9ylvo52Rs46yP/TljzOYNREGHV5duEFBJbl5M3sSTkWXzU0+Gj
```

Key fingerprint: ssh-rsa 2048 d0:91:90:b5:4d:e0:b6:00:b1:07:4a:cc:c7:51:44:73

Key comment: rsa-key-20170322

Key passphrase:

Confirm passphrase:

Actions

Generate a public/private key pair

Load an existing private key file

Save the generated key

Parameters

Type of key to generate:
 RSA DSA ECDSA ED25519 SSH-1 (RSA)

Number of bits in a generated key:

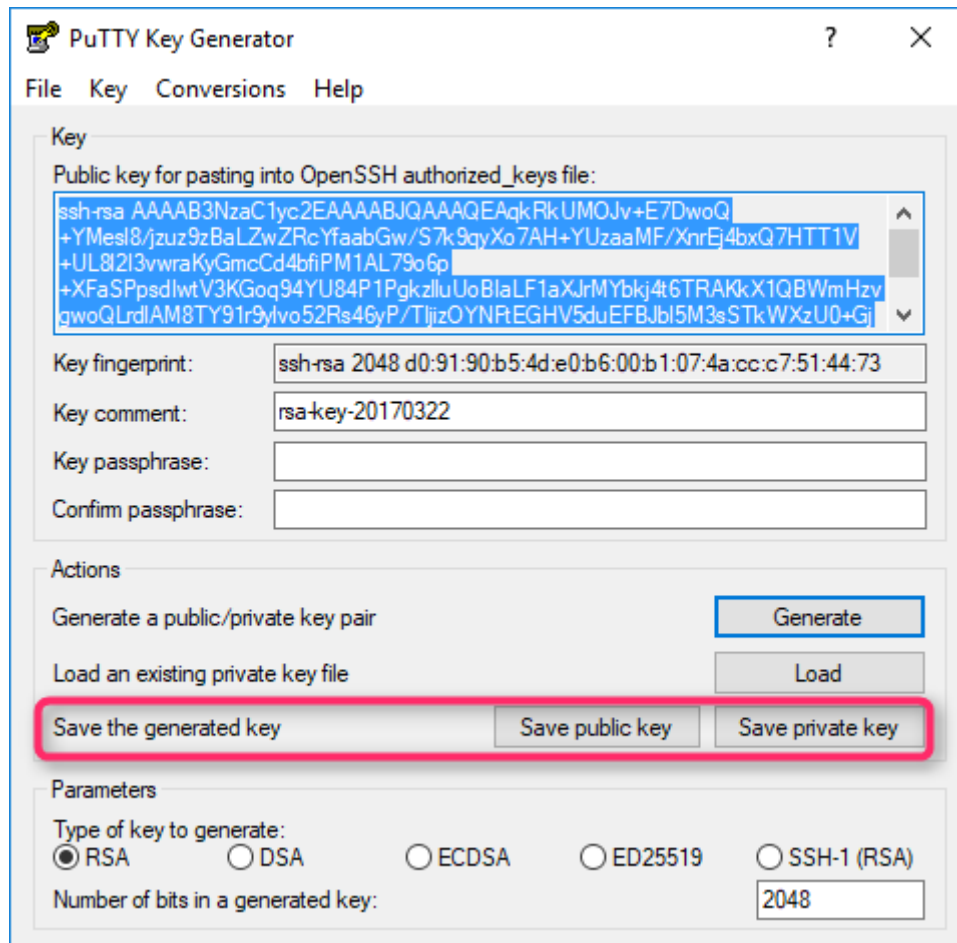



Create Azure Container Ser... □ ×



1 Basics ✓
Done

2 Master configuration >
Provide master information

3 Agent configuration >
Provide agent information

4 Summary >
Azure Container Service

Master configuration □ ×

* DNS name prefix ⓘ
 ✓

Master credentials

* User name ⓘ
 ✓

* SSH public key ⓘ

```
---- BEGIN SSH2 PUBLIC KEY ----  
Comment: "rsa-key-20170307"  
AAAAB3NzaC1yc2EAAAABJQAAAQEA50t
```

✓

Settings

Master count ⓘ
 ▼

VM diagnostics ⓘ



Create Azure Container Ser... □ ×



1 Basics ✓
Done

2 Master configuration ✓
Done

3 Agent configuration >
Provide agent information

4 Summary >
Azure Container Service

Agent configuration □ ×

* Agent count ⓘ

1

* Agent virtual machine size ⓘ

1x Standard DS2 >

OK



Create Azure Container Ser... □ ×



1 Basics Done ✓

2 Master configuration Done ✓

3 Agent configuration Provide agent information >

4 Summary Azure Container Service >

Agent configuration □ ×

* Agent count ⓘ

* Agent virtual machine size ⓘ

1x Standard DS2 >

OK





Create Azure Container Ser... □ ×



1 Basics ✓
Done

2 Master configuration ✓
Done

3 Agent configuration >
Provide agent information

4 Summary >
Azure Container Service

Agent configuration □ ×

* Agent count ⓘ

1

* Agent virtual machine size ⓘ >

1x Standard_A1_v2

OK



Summary

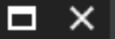

Validation passed



Basics

Subscription Visual Studio Enterprise
Resource group acdppbac
Location North Europe



Orchestrator DC/OS



Master configuration

DNS name prefix acdacs1
User name olmich
SSH public key ---- BEGIN SSH2 PUBLIC KEY ---- Comment: "rsa-key-20170307" ...
Master count 1
VM diagnostics Disabled



Agent configuration

Agent count 1
Agent virtual machine size Standard_A1_v2



OK

[Download template and parameters](#)



Summary

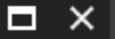

Validation passed



Basics

Subscription Visual Studio Enterprise
Resource group acdppbac
Location North Europe



Orchestrator DC/OS



Master configuration

DNS name prefix acdacs1
User name olmich
SSH public key ---- BEGIN SSH2 PUBLIC KEY ---- Comment: "rsa-key-20170307" ...
Master count 1
VM diagnostics Disabled



Agent configuration

Agent count 1
Agent virtual machine size Standard_A1_v2



OK

[Download template and parameters](#)



Template



Download Add to library Deploy



Automate deploying resources with Azure Resource Manager templates in a single, coordinated operation.



Template Parameters CLI CLI 2.0 (Preview) PowerShell .NET Ruby



Parameters (14)



Variables (18)



Resources (1)



[concat('containerservice-', resourc...



```
1 {
2   "$schema": "https://schema.management.azure.com/schemas/2019-04-01/azureResourceTemplates.json#",
3   "contentVersion": "1.0.0.0",
4   "parameters": {
5     "masterDnsNamePrefix": {
6       "type": "string",
7       "metadata": {
8         "description": "Sets the
9         domain name and the regionalized DNS zone
10      }
11    },
12    "agentDnsNamePrefix": {
13      "type": "string",
14      "metadata": {
15        "description": "Sets the
16        domain name and the regionalized DNS zone
17      }
18    }
19  }
20 }
```



New

Resource groups

All resources

Recent

App Services

Virtual machines (classic)

Virtual machines

SQL databases

Cloud services (classic)

Security Center

Subscriptions

Azure Active Directory

Monitor

Dashboard

+ New dashboard

Edit dashboard

Share

... X

All resources
ALL SUBSCRIPTIONS

- acdppbookcs
- acdsiotdemo
- acdiotdemo
- ServiceMap(acdberlin)
- acdsqlddev
- acdberlin
- acdeventhubdev-ns
- acdiotthdev
- acdiot

[See more](#)

Service health MY RESOURCES





New

Resource groups

All resources

Recent

App Services

Virtual machines (classic)

Virtual machines

SQL databases

Cloud services (classic)

Security Center

Subscriptions

Azure Active Directory

Monitor

Dashboard

+ New dashboard

Edit dashboard

Share

... X

All resources
ALL SUBSCRIPTIONS

- containerservice-acd|
- acdppbookcs
- acdcsiotdemo
- acdiotdemo
- ServiceMap(acdberlir
- acdsqlddev
- acdberlin
- acdeventhubdev-ns
- acdiotthdev

[See more](#)

Service health MY RESOURCES





acdppbac
Resource group



Search (Ctrl+/)



Overview



Activity log



Access control (IAM)



Tags

SETTINGS



Quickstart



Resource costs



Deployments



Properties



Locks



Automation script



MONITORING



Add



Columns

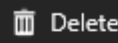

Delete

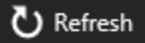

Refresh



More

Essentials

Filter by name...

24 items

NAME



dcos-master-availabilitySet-877AA539



containerservice-acdppbac



dcos-agent-lb-877AA539



dcos-master-lb-877AA539



dcos-master-877AA539-nic-0



dcos-agent-private-nsg-877AA539



dcos-agent-public-nsg-877AA539



dcos-master-nsg-877AA539



dcos-agent-ip-acdacs1agents-877AA539



dcos-master-in-acdacs1mmt-877AA539



acdppbac
Resource group



Search (Ctrl+/)



Overview



Activity log



Access control (IAM)



Tags

SETTINGS



Quickstart



Resource costs



Deployments



Properties



Locks



Automation script



MONITORING



Add

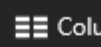

Columns

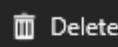

Delete

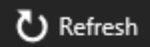

Refresh



More

Essentials

Filter by name...

24 items

NAME

cuixclo3inuqinzagntpri2

i0lxclo3lhuqih2agntpri3

lxclo3lhuqih2agntpri4

lxclo3lhuqih2diag0

lxclo3lhuqih2mstr0

o0lxclo3lhuqih2agntpri4

dcos-master-877AA539-0

dcos-agent-private-877AA539-vmss0

dcos-agent-public-877AA539-vmss0

dcos-vnet-877AA539



containerservice-acdppbac

Container service

Search (Ctrl+/)

Overview

Activity log

Access control (IAM)

Tags

SETTINGS

Quickstart

Agents

Releases

Properties

Locks

Automation script

SUPPORT + TROUBLESHOOTING

Delete

Essentials ^

Resource group (change)

acdppbac

Location

North Europe

Subscription name (change)

Visual Studio Enterprise

Subscription ID

02f13438-c22f-4f1b-ad33-0f9f2eef0ba6

1 agent pool

| NAME | VM SIZE |
|-----------|----------------|
| agentpool | Standard_A1_v2 |

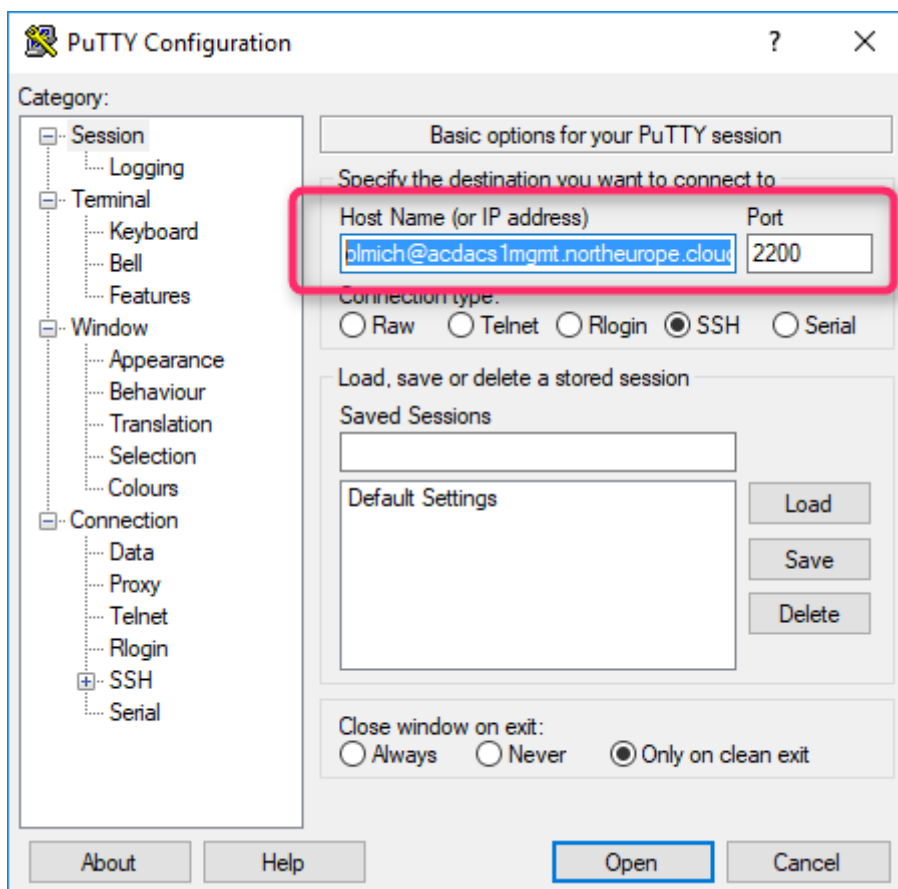
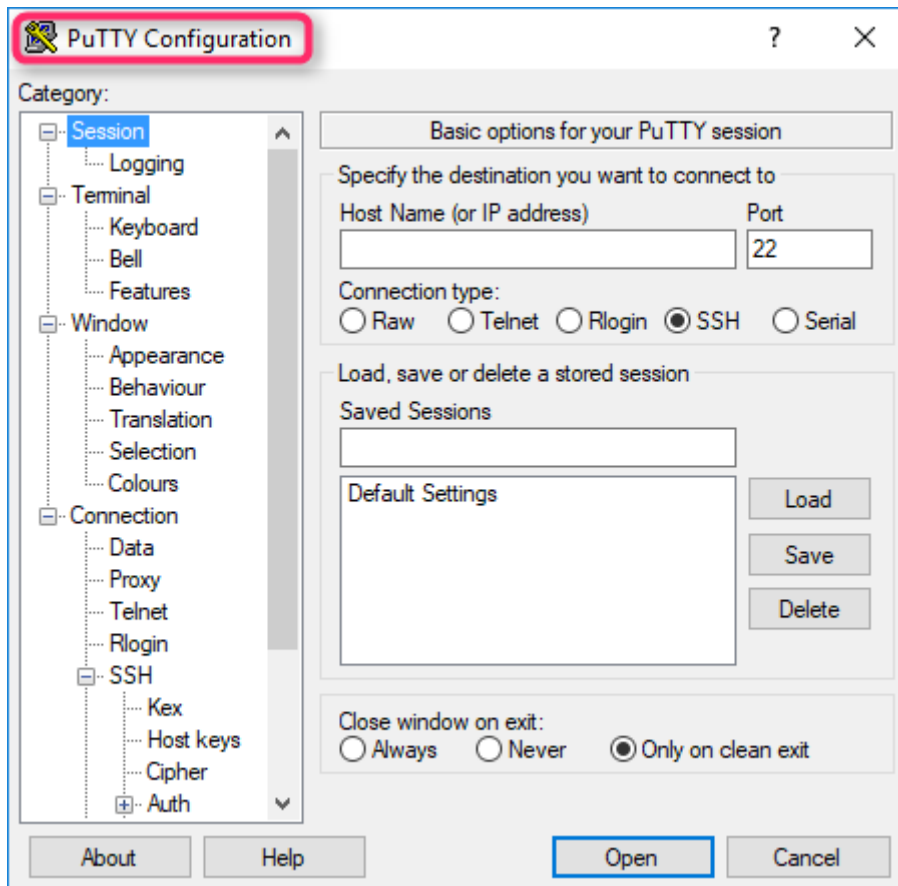

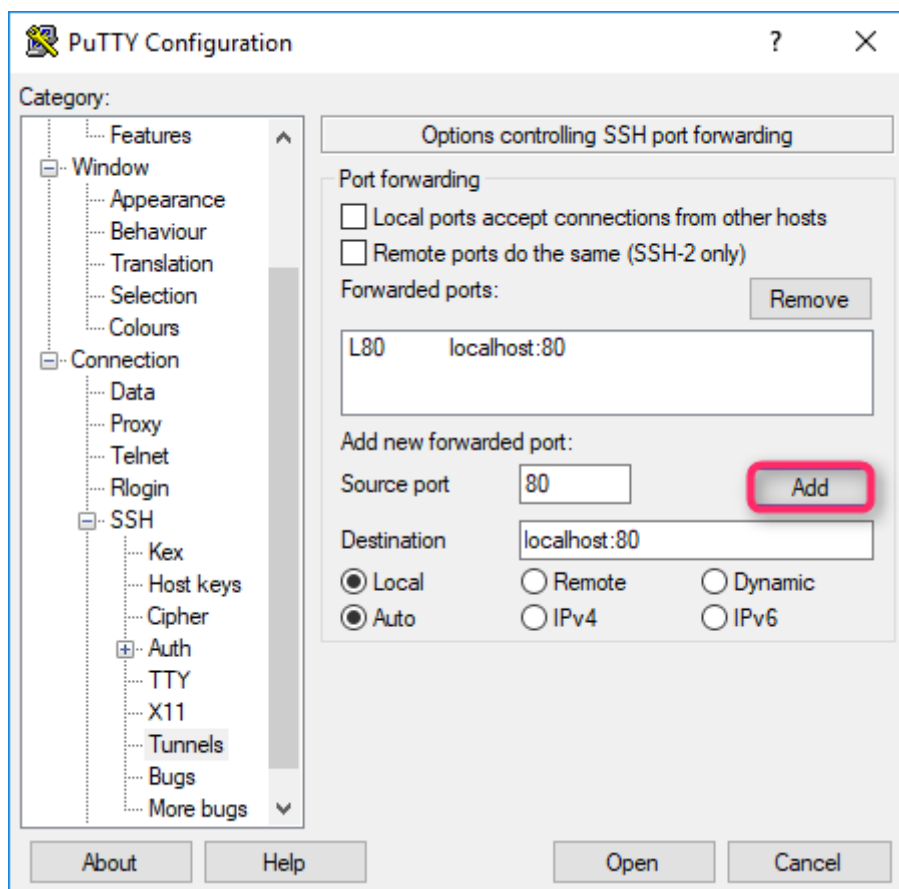
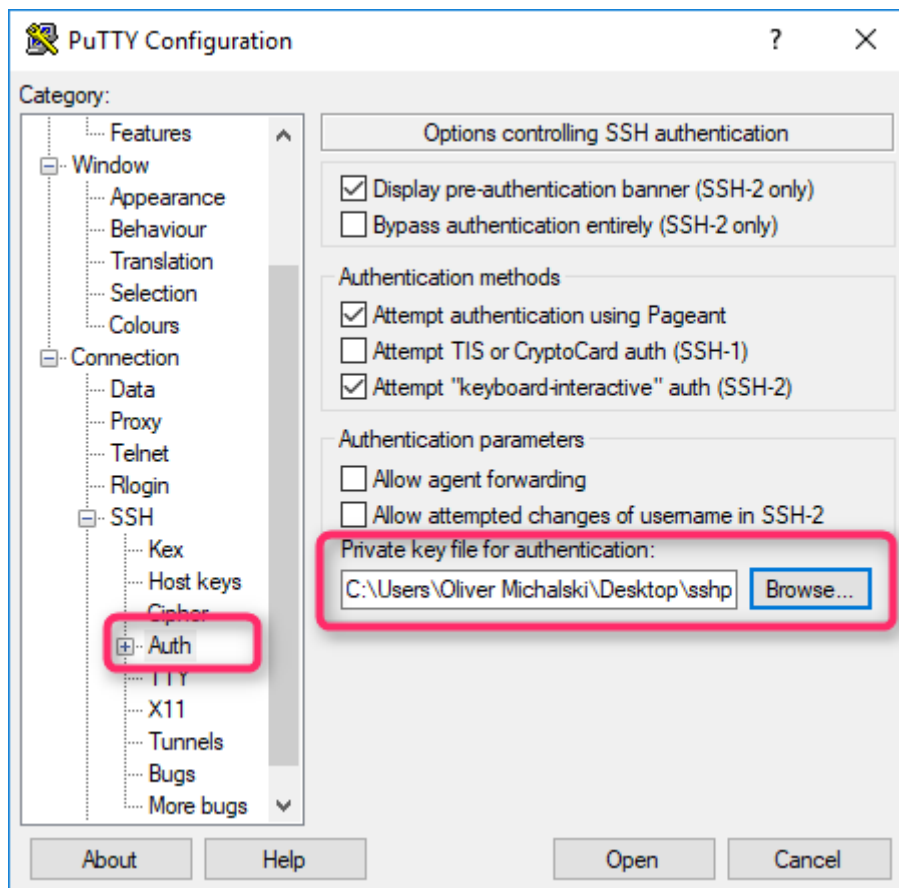

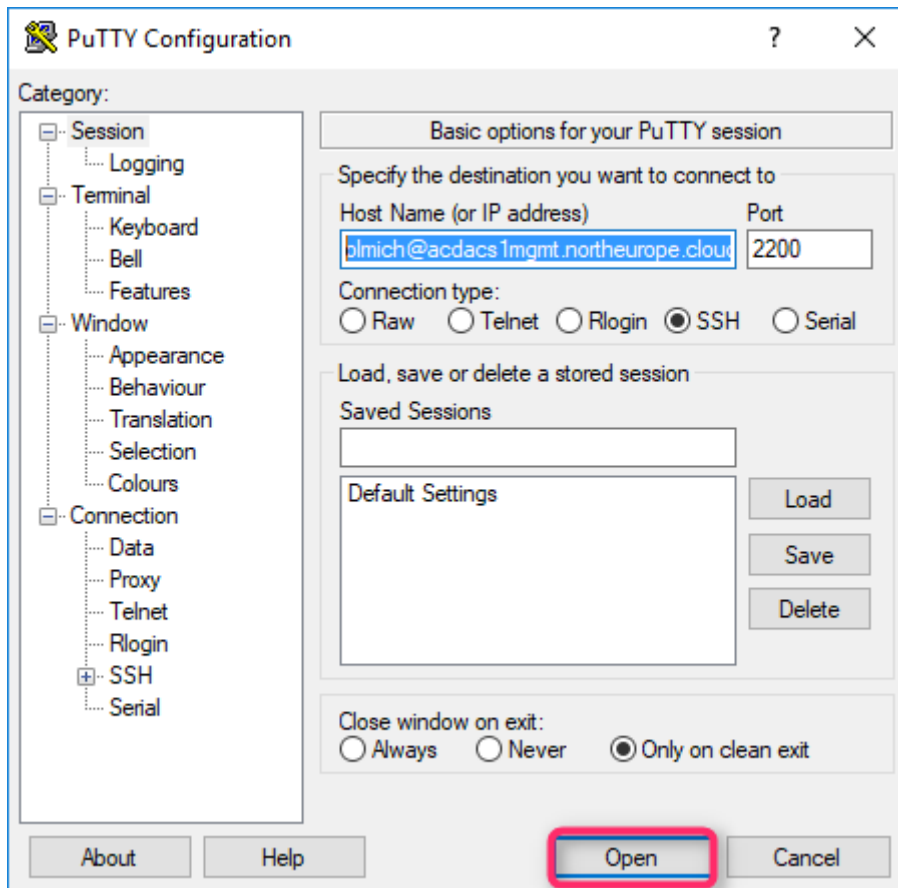

dcos-master-ip-acdacs1m...
172.16.0.5

Dashboard

Services

Jobs

Network

Nodes

Universe

System

CPU Allocation

0%
0 of 2 Shares

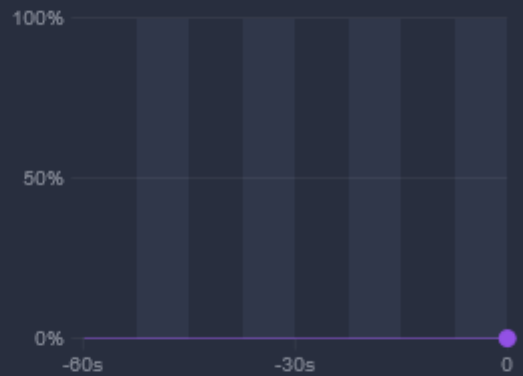

Services Health

No Services Running

dcos-master-ip-acdacs1m...
172.16.0.5

 Dashboard

 Services

 Jobs

 Network

 Nodes

 Universe

 System

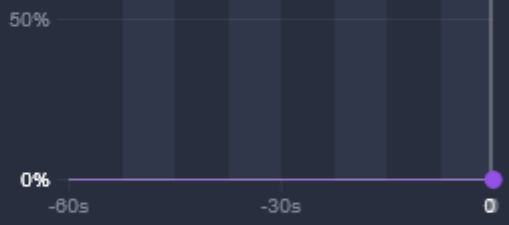

Services Health

No Services Running

Use the DC/OS command line tools to find and install services.



dcos-master-ip-acdacs1m...
172.16.0.5

- Dashboard
- Services
- Jobs
- Network
- Nodes
- Universe
- System**

Overview

Filter | All 35 | He

- NAME
- Admin Router Agent
- Admin Router Master
- Admin Router Reloader
- Admin Router Reloader
- Admin Router Reloader Timer
- Admin Router Reloader Timer
- Diagnostics
- Diagnostics socket
- DNS Dispatcher
- DNS Dispatcher Watchdog

dcos-master-ip-acdacs1m...
172.16.0.5

- Dashboard
- Services
- Jobs
- Network
- Nodes
- Universe**
- System

Packages Installed

Search

Selected Packages



arangodb3

3.1.x

Install Package



artifi

4.

Install

dcos-master-ip-acdacs1m...
172.16.0.5

- Dashboard
- Services
- Jobs
- Network
- Nodes
- Universe**
- System

Packages Installed



spark

1.0.8-2.1.0-1

Install Package

Community Packages



arangodb

0.4.0



artifactory-lb

4.14.1



avi

2.0



STATUS

- Running
- Deploying
- Suspended
- Delayed
- Waiting

HEALTH

- Healthy
- Unhealthy
- Unknown

RESOURCES

- Volumes

Applications

Name ▲

No Ap
Do more with M



STATUS

- Running
- Deploying
- Suspended
- Delayed
- Waiting

HEALTH

- Healthy
- Unhealthy
- Unknown

RESOURCES

- Volumes

Applications

Name ▲

Create G
Enter a path for the ne

Create Group



STATUS

- Running
- Deploying
- Suspended
- Delayed
- Waiting

HEALTH

- Healthy
- Unhealthy
- Unknown

RESOURCES

- Volumes

Applications

Name ▲

New Application

General

Docker Container

Ports & Service Discovery

Environment Variables

Labels

Health Checks

Volumes

Optional

ID

CPU(s) Memory (MB)

Command

May be left blank if a container image is used

Master a497cf31-0add-4ee6-adad-ce019024fd28

Cluster:
dcos-master-ip-acdacs1mgmt-877AA539
Server: 172.16.0.5:5050
Version: 1.0.3
Built: a month ago by
Started: yesterday
Elected: yesterday

LOG

Agents

| | |
|-------------|---|
| Activated | 2 |
| Deactivated | 0 |

Tasks

| | |
|----------|---|
| Staging | 0 |
| Starting | 0 |
| Running | 0 |
| Killing | 0 |
| Finished | 0 |
| Killed | 0 |

Active Tasks

| ID | Name | State |
|------------------|------|-------|
| No active tasks. | | |

Completed Tasks

| ID | Name | State |
|---------------------|------|-------|
| No completed tasks. | | |

Orphan Tasks

| ID | Name | State |
|------------------|------|-------|
| No orphan tasks. | | |

Active Frameworks

| ID ▼ | Host | User | Name | Role | Principal |
|---------------------------|------------|------|-----------|--------------|---------------|
| ...adad-ce019024fd28-0001 | 172.16.0.5 | root | metronome | * | |
| ...adad-ce019024fd28-0000 | 172.16.0.5 | root | marathon | slave_public | dcos_marathon |

Inactive Frameworks

| ID ▼ | Host | User | Name | Role | Principal | Active Tasks | CPUs |
|------|------|------|------|------|-----------|--------------|------|
|------|------|------|------|------|-----------|--------------|------|

Completed Frameworks

| ID ▼ | Host | User | Name | Role | Principal |
|------|------|------|------|------|-----------|
|------|------|------|------|------|-----------|

Agents

| ID ▼ | Host | CPUs (Allocated / Total) | GPUs (Allocated / Total) |
|-------------------------|-----------|--------------------------|--------------------------|
| ...adad-ce019024fd28-S1 | 10.0.0.4 | 0 / 1 | 0 / 0 |
| ...adad-ce019024fd28-S0 | 10.32.0.4 | 0 / 1 | 0 / 0 |

Outstanding Offers

| ID ▼ | Framework | Host | CPU |
|------|-----------|------|-----|
|------|-----------|------|-----|

Chapter 9: Implementing Azure Security



| Azure AD Privileged Identity Management | | | |
|---|--|-----------|-----|
| Results | | | |
| NAME | | PUBLISHER | CAT |
|  Azure AD Privileged Identity Management | | Microsoft | Sec |



Privileged Identity Man... ✪ □ ×
Security + Identity

↻ Reverify

Privileged Identity Management and Azure Multi-Factor Authentication (MFA) work together to help you manage access to secure applications and services. Before you get started with PIM, we need to make sure that you're able to use MFA.

Verify your identity with Azure MFA now. If you haven't registered yet, we'll help you do that.

 Verify my identity 

Privileged Identity Man...   
Security + Identity



 Reverify



Verification completed successfully. Click "Create" to start the Privileged Identity Management process

Protect your organization 
Standardverzeichnis

- 1 Discover privileged roles >
- 2 Convert users to eligible >
- 3 Review the changes to your users in privileged roles >

Privileged Identity Mana...   
Standardverzeichnis



Activate my roles



Manage privileged roles



Review privileged access

Privileged Identity Management

Contoso



Settings



Refresh



Wizard

Activity

Add tiles (+)

Alerts

2

Roles are being activated too frequently

Administrators aren't using their privileged roles

Users in admin roles

17 Users



Audit history



Quick start

Role summary

Add tiles (+)

Roles

| ROLE NAME | MFA ENABLED | USERS | ACTIVE | ELIGIBLE |
|-------------------------------|-------------|-------|----------|----------|
| Security Reader | Yes | 1 | 1 (100%) | 0 (0%) |
| Global Administrator | Yes | 9 | 5 (56%) | 4 (44%) |
| Privileged Role Administra... | Yes | 11 | 3 (27%) | 8 (73%) |
| Security Administrator | Yes | 9 | 3 (33%) | 7 (78%) |
| Password Administrator | Yes | 2 | 0 (0%) | 2 (100%) |
| User Administrator | Yes | 2 | 1 (50%) | 2 (100%) |

Access reviews

Add tiles (+)

Current access reviews

[CLICK HERE TO VIEW ALL REVIEWS](#)

Security Administrator

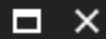

Save Discard

Activations

Maximum Activation duration (hours) ⓘ

6

Notifications

Send email notifying admins of activation ⓘ

Incident/Request Ticket

Require Incident/Request ticket number during activation ⓘ

Multi-Factor Authentication

Require Azure Multi-Factor Authentication for activation ⓘ

Policy name

Sign-in risk remediation policy

Assignments

 Users ⓘ

All users



 Conditions ⓘ

Select conditions



Controls

 Access ⓘ

Select a control



Review

 Estimated impact ⓘ

Number of sign-ins impacted



Enforce Policy

On

Off

Policy name

User risk remediation policy

Assignments

 Users ⓘ

All users



 Conditions ⓘ

Select conditions



Controls

 Access ⓘ

Select a control



Review

 Estimated impact ⓘ

Number of users impacted



Enforce Policy

On

Off

standardverzeichnis

[DASHBOARD](#)[USERS](#)[GROUPS](#)[APPLICATIONS](#)[DOMAINS](#)[DIRECTORY INTEGRATION](#)[CONFIGURE](#)

| SECURITY AND HEALTH STATUS | STATUS (LAST 30 DAYS) | DETAILS | |
|---|-----------------------|--|--|
| PRODUCTIVITY | | | |
| > Application Usage | 6 | View Application Usage | |
| SECURITY | | | |
| > Users At Risk | 0 | View Users At Risk | |
| > Risk Events | 0 | View Risk Events | |
| MANAGEABILITY | | | |
| > Self-Service Password Resets out of Registrations | 0 out of 0 | View SSPR Activity | |
| > Self-Service Group Management | 0 | View SSGM Activity | |
| CONFIGURE SERVICE | | | |
| PRODUCTIVITY | | | |
| > Integrated Applications | 3 application(s) used | Configure/Add/Remove | |
| SECURITY | | | |
| > Cloud Multi-Factor Authentication | Enabled for 0 user(s) | Configure | |
| > Security and Usage Reports | Opted In | View Reports | |
| MANAGEABILITY | | | |
| > Connect Health | Disabled | Configure | |
| > Tenant Branding | Not Configured | Configure | |
| > Self Service Password Reset | Disabled | Configure | |

ee sync for user settings and app data. Enable Enterprise State Roaming.

[LEARN HOW TO ENABLE](#)[DON](#)

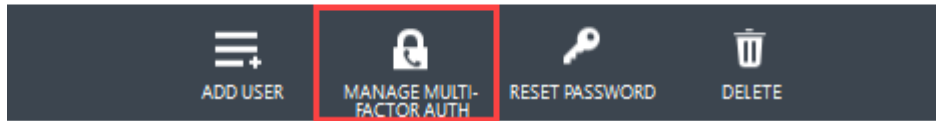

Microsoft Azure

multi-factor authentication

users service settings

Note: only users licensed to use Microsoft Online Services are eligible for Multi-Factor Authentication. [Learn more about how to](#) Before you begin, take a look at the [multi-factor auth deployment guide](#).

View: ▾



Multi-Factor Auth status: ▾

[bulk update](#)

| <input type="checkbox"/> | DISPLAY NAME ▲ | USER NAME | MULTI-FACTOR AUTH STATUS |
|--------------------------|----------------|------------|--------------------------|
| <input type="checkbox"/> | Frederik | [REDACTED] | Disabled |
| <input type="checkbox"/> | [REDACTED] | [REDACTED] | [REDACTED] |
| <input type="checkbox"/> | [REDACTED] | [REDACTED] | [REDACTED] |

| <input checked="" type="checkbox"/> | DISPLAY NAME ▲ | USER NAME | MULTI-FACTOR AUTH STATUS |
|-------------------------------------|----------------|------------|--------------------------|
| <input checked="" type="checkbox"/> | Frederik | [REDACTED] | Disabled |
| <input type="checkbox"/> | [REDACTED] | [REDACTED] | [REDACTED] |
| <input type="checkbox"/> | [REDACTED] | [REDACTED] | [REDACTED] |



About enabling multi-factor auth

Please read the [deployment guide](#) if you haven't already.

If your users do not regularly sign in through the browser, you can send them to this link to register for multi-factor auth: <https://aka.ms/MFASetup>

enable multi-factor auth

cancel







Updates successful

Multi-factor auth is now enabled for the selected accounts.

close

Multi-Factor Authentication

Results

| NAME | PUBLISHER |
|---|--------------|
|  Multi-Factor Authentication | Microsoft |
|  Azure Active Directory | Microsoft |
|  Soha Cloud - VPN Plan | Soha Systems |
|  Soha Cloud - Premium Plan | Soha Systems |

Create [↗](#)

NEW



MEDIA SERVICE
NOT AVAILABLE



SERVICE BUS



MOBILE ENGAGEMENT
NOT AVAILABLE



VISUAL STUDIO TEAM SERVICES



BIZTALK SERVICE



CDN
NOT AVAILABLE



AUTOMATION
NOT AVAILABLE



SCHEDULER
NOT AVAILABLE

DIRECTORY



QUICK CREATE

ACCESS CONTROL

MULTI-FACTOR AUTH PROVIDER



Konto schützen

Aufgrund der aktivierten Überprüfung in zwei Schritten muss die Anforderung 88ACD in Ihrer Microsoft Authenticator-App genehmigt werden.

 Es wird auf die Genehmigung der Anforderung 88ACD gewartet.

Ich melde mich häufig auf diesem Gerät an. Bitte keine Anforderungsgenehmigungen mehr anfordern.

[Probleme?](#)

Abbrechen

[Nutzungsbedingungen](#)

[Datenschutz und Cookies](#)

[Impressum](#)

multi-factor authentication and location based access rules

ENABLE ACCESS RULES

OFF

ON

APPLY TO

ALL USERS

GROUPS

Except

RULES

Require multi-factor authentication

Require multi-factor authentication when not at work

Block access when not at work

[Click here to define/edit your work network location](#)

device based access rules

ENABLE ACCESS RULES

OFF

ON

New
PREVIEW

Info

Name

Example: 'Device compliance app policy'

Assignments

- Users and groups
0 users and groups selected
- Cloud apps
0 cloud apps selected
- Conditions
0 conditions selected

Controls

- Grant
0 controls selected

Enable policy

On Off

Conditions
PREVIEW

Info

- Sign-in risk
Not configured
- Device platforms
Not configured
- Locations
Not configured
- Client apps
Not configured

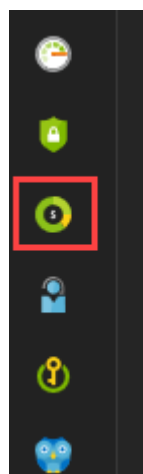

Billing

Standardverzeichnis - PREVIEW

 Search (Ctrl+/)

 Overview

 Diagnose and solve problems

BILLING ACCOUNT

 Invoices



 Contact info

 Billing address

 Payment methods

SUPPORT + TROUBLESHOOTING

 New support request

 New subscription  Manage

3/9/2017



The billing information shown here pertains to subscriptions you've created. To view billing information for a subscription with, go to the blade for that subscription or resource.

Billing

Billing history

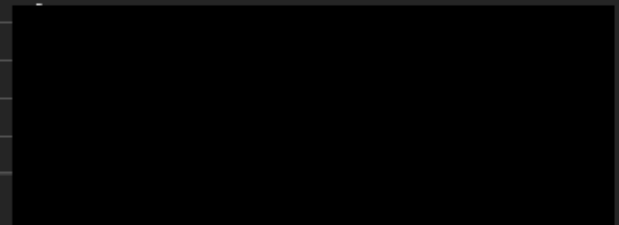

Payment methods



Subscription costs

Active subscriptions you've created

2 Subscriptions 

| | SUBSCRIPTION ID | NAME | OFFER | LA |
|---|-----------------|-------------------|-------|-----|
|  | [REDACTED] | Visual Studio ... | MSDN | 0.0 |
|  | [REDACTED] | Visual Studio ... | MSDN | 0.0 |



Visual Studio Enterprise

Subscription

Search (Ctrl+*/*)



Overview



Access control (IAM)



Diagnose and solve problems

BILLING



Invoices



Cost analysis



External services



Payment methods

















Partner information



Email my invoice

Roles

Visual Studio Enterprise

| NAME | USERS | GROUPS |
|--|-------|--------|
|  Owner ⓘ | 0 | 1 |
|  Contributor ⓘ | 0 | 0 |
|  Reader ⓘ | 0 | 0 |
|  API Management Service Contributor ⓘ | 0 | 0 |
|  API Management Service Operator Role ⓘ | 0 | 0 |
|  API Management Service Reader Role ⓘ | 0 | 0 |
|  Application Insights Component Contributor ⓘ | 0 | 0 |
|  Automation Operator ⓘ | 0 | 0 |
|  Backup Contributor ⓘ | 0 | 0 |
|  Backup Operator ⓘ | 0 | 0 |
|  Backup Reader ⓘ | 0 | 0 |
|  BizTalk Contributor ⓘ | 0 | 0 |
|  CDN Endpoint Contributor ⓘ | 0 | 0 |
|  CDN Endpoint Reader ⓘ | 0 | 0 |

Owner

Visual Studio Enterprise

+ Add ≡ Permissions

| USER | ACCESS |
|---|-----------|
|  Subscription admins ⓘ | Inherited |

Add inbound security rule

AzureDemoVM-nsg

 Basic

* Name 

denyRdpIn 

* Priority 

1100 

* Source 

Any CIDR block Tag

* Protocol 

Any TCP UDP

* Source port range 

*

* Destination 

Any CIDR block Tag

* Destination port range 

3389 

* Action 

Deny Allow



implementingazuredemo - Encryption

Storage account

Search (Ctrl+/)

- Overview
- Activity log
- Access control (IAM)
- Tags
- Diagnose and solve problems

SETTINGS

- Access keys
- Configuration
- Shared access signature
- Properties
- Locks
- Automation script

BLOB SERVICE

- Containers
- CORS
- Custom domain
- Encryption**
- Metrics
- Usage

Save Discard



Storage service encryption protects your data at rest. Azure Storage encrypts y access it.

Currently, this feature is available only for the Azure Blob service. Note that aft blobs in this storage account will remain unencrypted.

[Learn more](#)

* Storage service encryption

Disabled Enabled

 Save  Discard

Storage service encryption prevents unauthorized access to your data. Currently, this feature is available for blobs in this storage account.

[Learn more](#)

* Storage service encryption





Disabled Enabled

Monitor - Activity log

Microsoft - PREVIEW

 Search (Ctrl+/)

EXPLORE

-  Activity log
-  Metrics
-  Diagnostics logs
-  Log search



MANAGE

-  Alerts

HEALTH

-  Resource health

ADVANCED

-  Application Insights
-  Management solutions

Columns Export Log search

Gain insights into Azure activities using log search and visualization for FREE

Select query ...



Insights (Last 24 hours): 0 failed deployments | 0 role a
fired | 0 outage notifications

* Subscription

Resource group

Resource

Resource type

Visual Studio Enterprise

All resource groups

All resources

All resource types

Timespan

Event category

* Event severity

Event initiated by

Last week

All categories

4 selected

Email or name or serv...

Apply

Reset

implementingazuredemo

Blob Containers

File Shares

Queues

Tables

\$MetricsCapacityBlob

\$MetricsHourPrimaryTransactionsBl

\$MetricsHourPrimaryTransactionsQ

\$MetricsHourPrimaryTransactionsTa

Security Center - Overview

Search (Ctrl+/)

GENERAL

Overview

Security policy

Quickstart

Welcome

PREVENTION

Recommendations

Partner solutions

DETECTION

Security alerts

Power BI Filter Log Integration

Getting things ready for your subscriptions. This may take a few minutes.

Prevention

Resource security health

Virtual machines

Networking

SQL & Data

HIGH SEVERITY 14 resources
HEALTHY 1 resource

Just in time VM access



PROTECTED 7 VMs
APPROVED REQUESTS 363 Total

Policy

Quickstart

Security policy

Visual Studio Enterprise

 Save  Discard

Data collection

Collect data from virtual machines ⓘ

On Off

Choose a storage account per regi...
(create automatically) >

Policy components



Prevention policy >



Email notifications >



Pricing tier >

Prevention policy

Visual Studio Enterprise

Show recommendations for

| | | |
|---------------------------------|--|------------------------------|
| System updates ⓘ | <input checked="" type="checkbox"/> On | <input type="checkbox"/> Off |
| OS vulnerabilities ⓘ | <input checked="" type="checkbox"/> On | <input type="checkbox"/> Off |
| Endpoint protection ⓘ | <input checked="" type="checkbox"/> On | <input type="checkbox"/> Off |
| Disk encryption | <input checked="" type="checkbox"/> On | <input type="checkbox"/> Off |
| Network security groups | <input checked="" type="checkbox"/> On | <input type="checkbox"/> Off |
| Web application firewall | <input checked="" type="checkbox"/> On | <input type="checkbox"/> Off |
| Next generation firewall | <input checked="" type="checkbox"/> On | <input type="checkbox"/> Off |
| Vulnerability Assessment | <input checked="" type="checkbox"/> On | <input type="checkbox"/> Off |
| Storage Encryption | <input checked="" type="checkbox"/> On | <input type="checkbox"/> Off |
| SQL auditing & Threat detection | <input checked="" type="checkbox"/> On | <input type="checkbox"/> Off |
| SQL Encryption | <input checked="" type="checkbox"/> On | <input type="checkbox"/> Off |

Recommendations

Filter

| DESCRIPTION ^ | RESOURCE ^ | STATE ^ | SEVERITY ^ | |
|--|-------------------|----------|------------|-----|
| Enable advanced security for subscriptions | 2 subscriptions | Resolved | ● High | ... |
| Enable data collection for subscriptions | 1 subscriptions | Resolved | ● High | ... |
| Add a Next Generation Firewall | 2 endpoints | Resolved | ● High | ... |
| Enable Network Security Groups on subnets | 2 subnets | Resolved | ● High | ... |
| Enable Auditing & Threat detection on SQL ... | projectnamic... | Open | ! High | ... |
| Enable Auditing & Threat detection on SQL ... | projectnamic... | Resolved | ● High | ... |
| Apply disk encryption | 3 virtual mac... | Open | ! High | ... |
| Enable encryption for Azure Storage Account | 11 storage acc... | Open | ! High | ... |
| Restrict access through Internet facing end... | 2 virtual mac... | Resolved | ▲ Medium | ... |
| Add a vulnerability assessment solution | 2 virtual mac... | Resolved | ▲ Medium | ... |
| Enable Transparent Data Encryption | projectnamic... | Resolved | ▲ Medium | ... |
| Provide security contact details | 2 subscriptions | Open | ⚠ Medium | ... |

Chapter 10: Skill Wrap Up and Migration Scenario

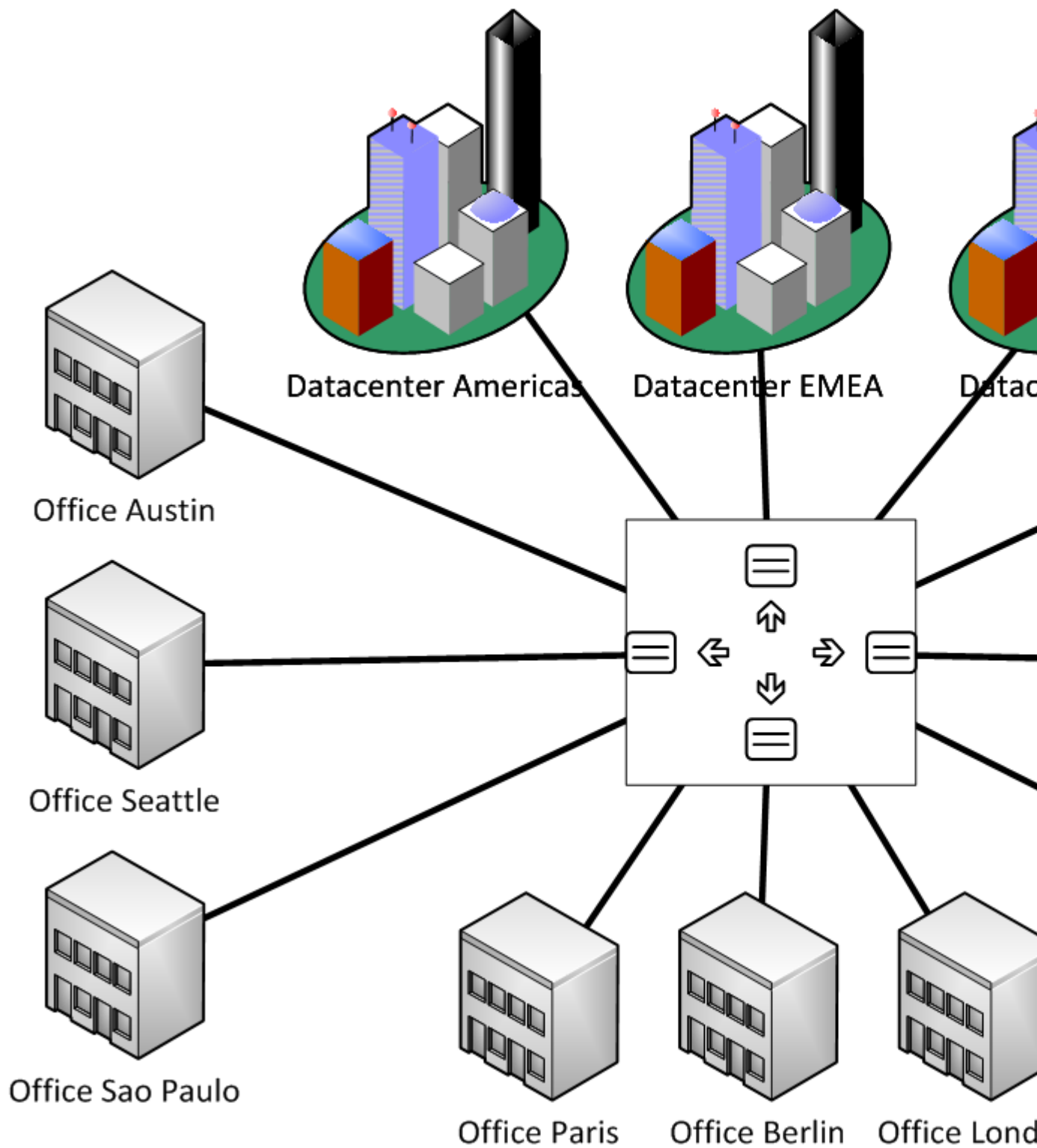

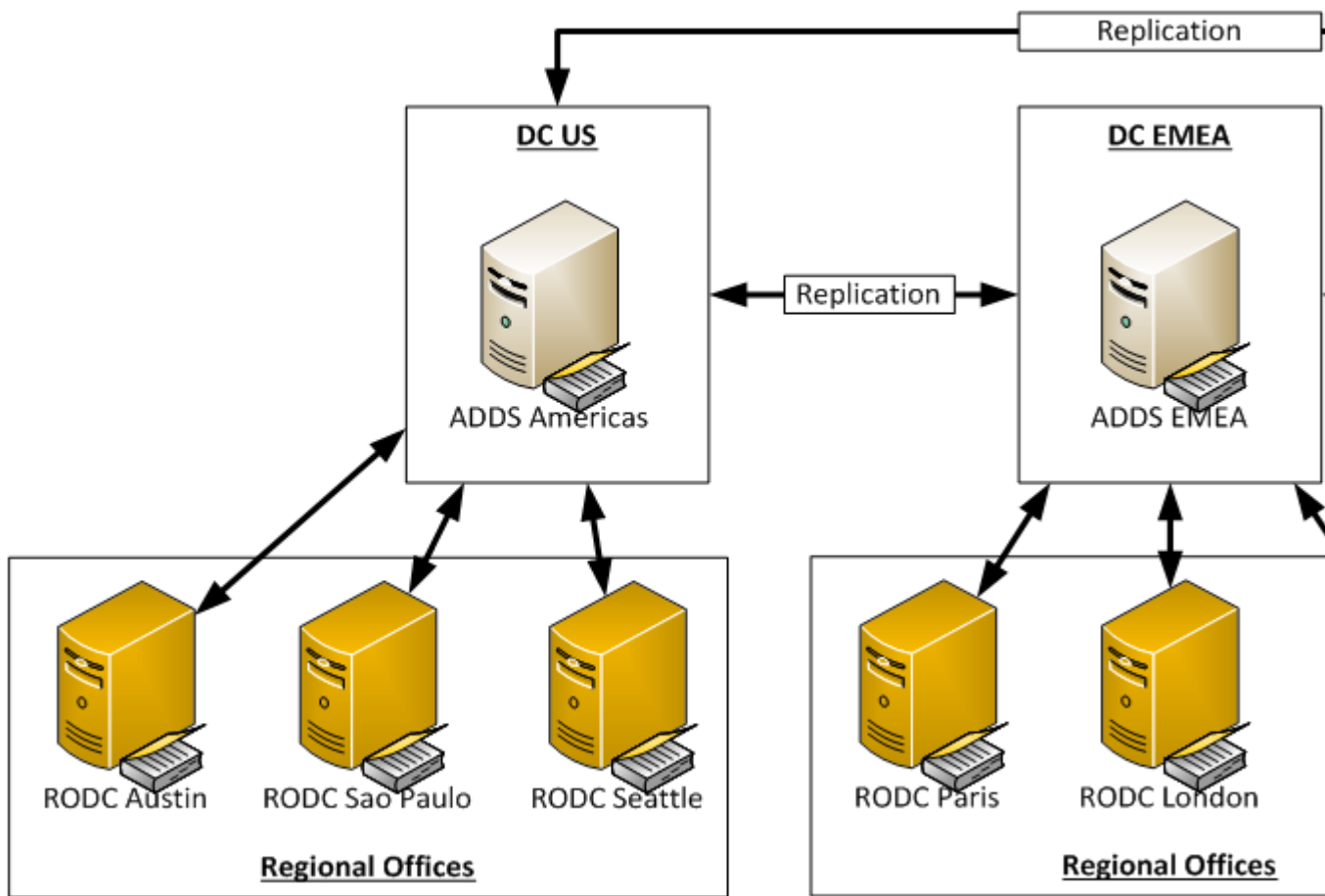

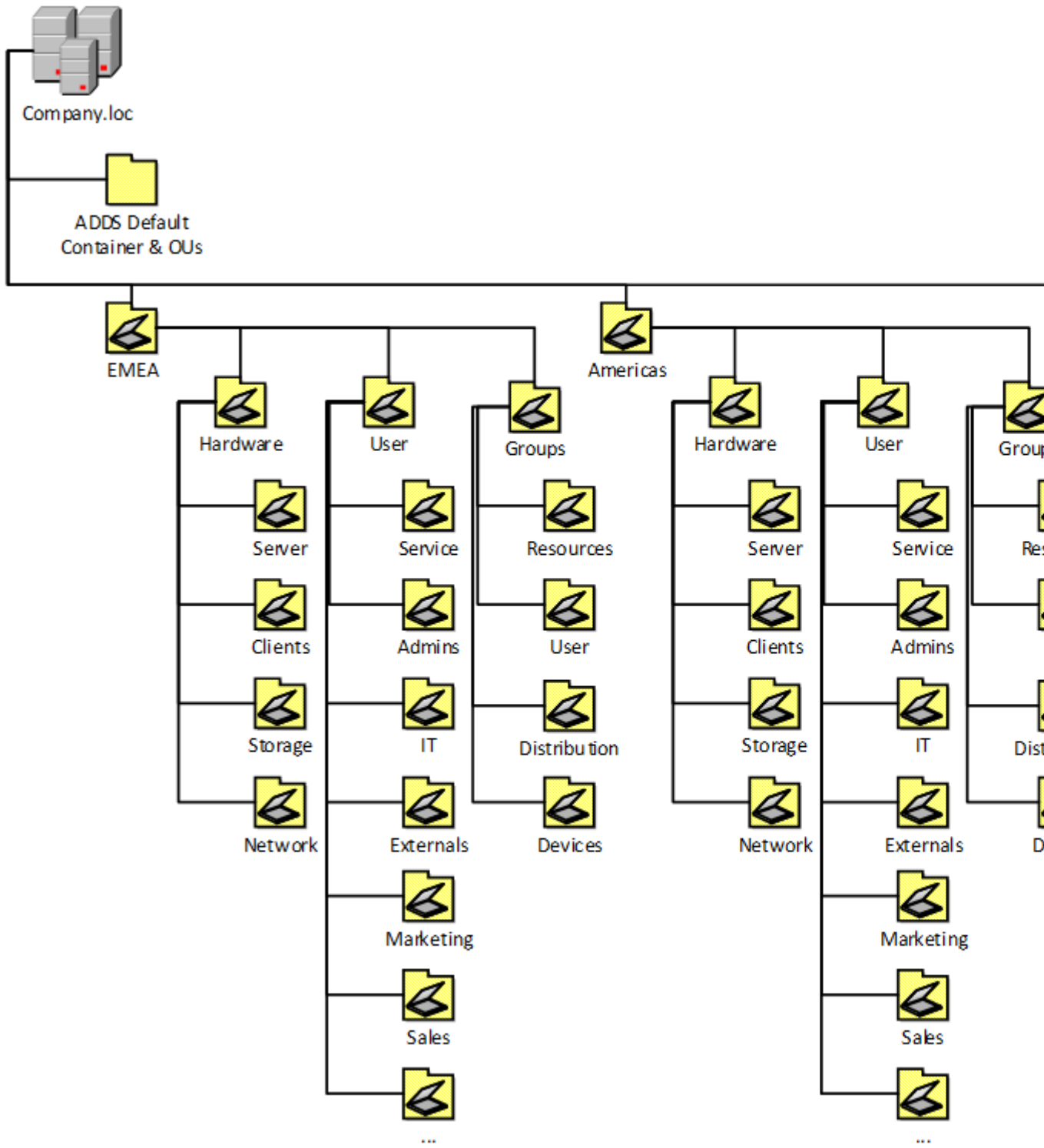

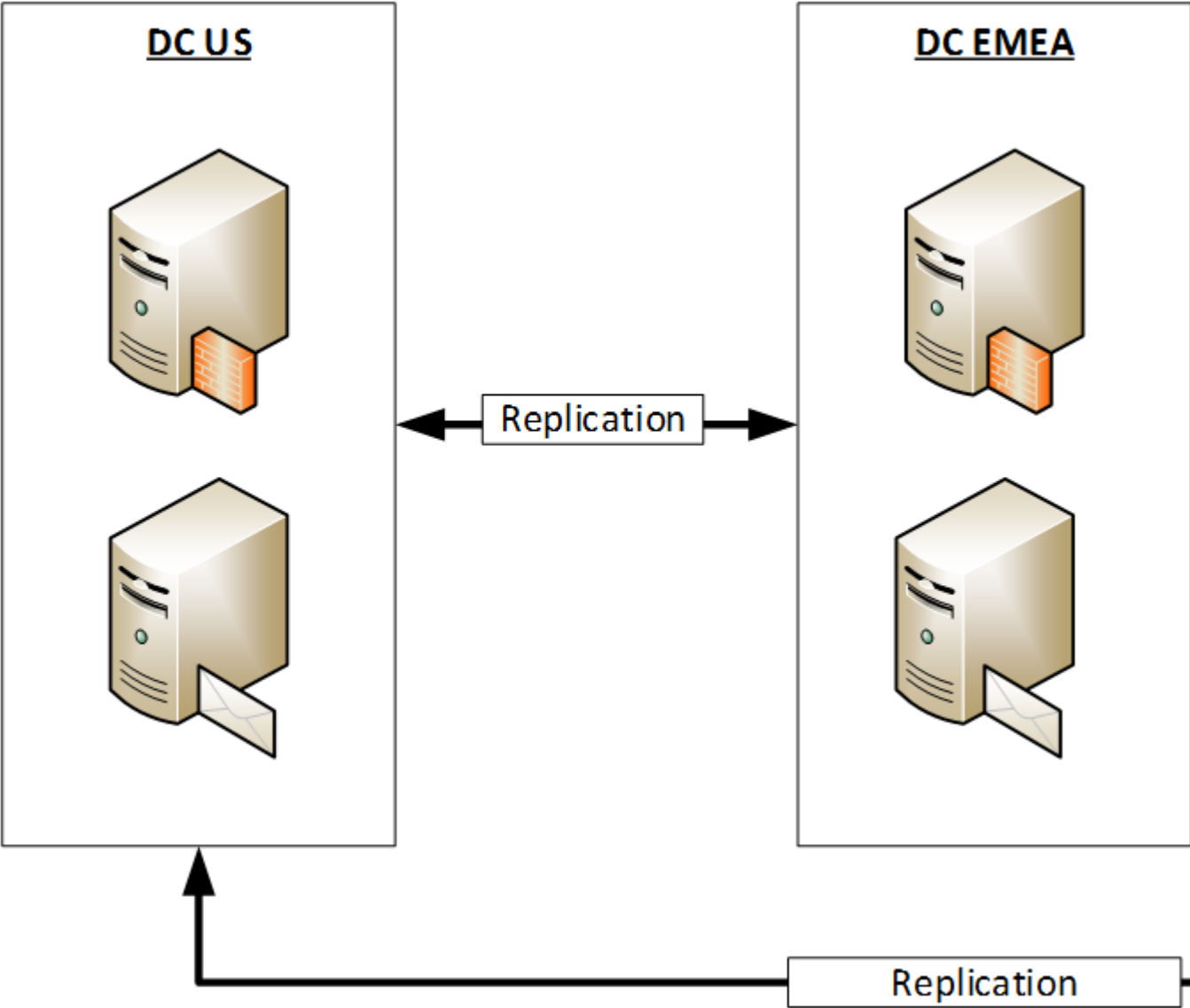

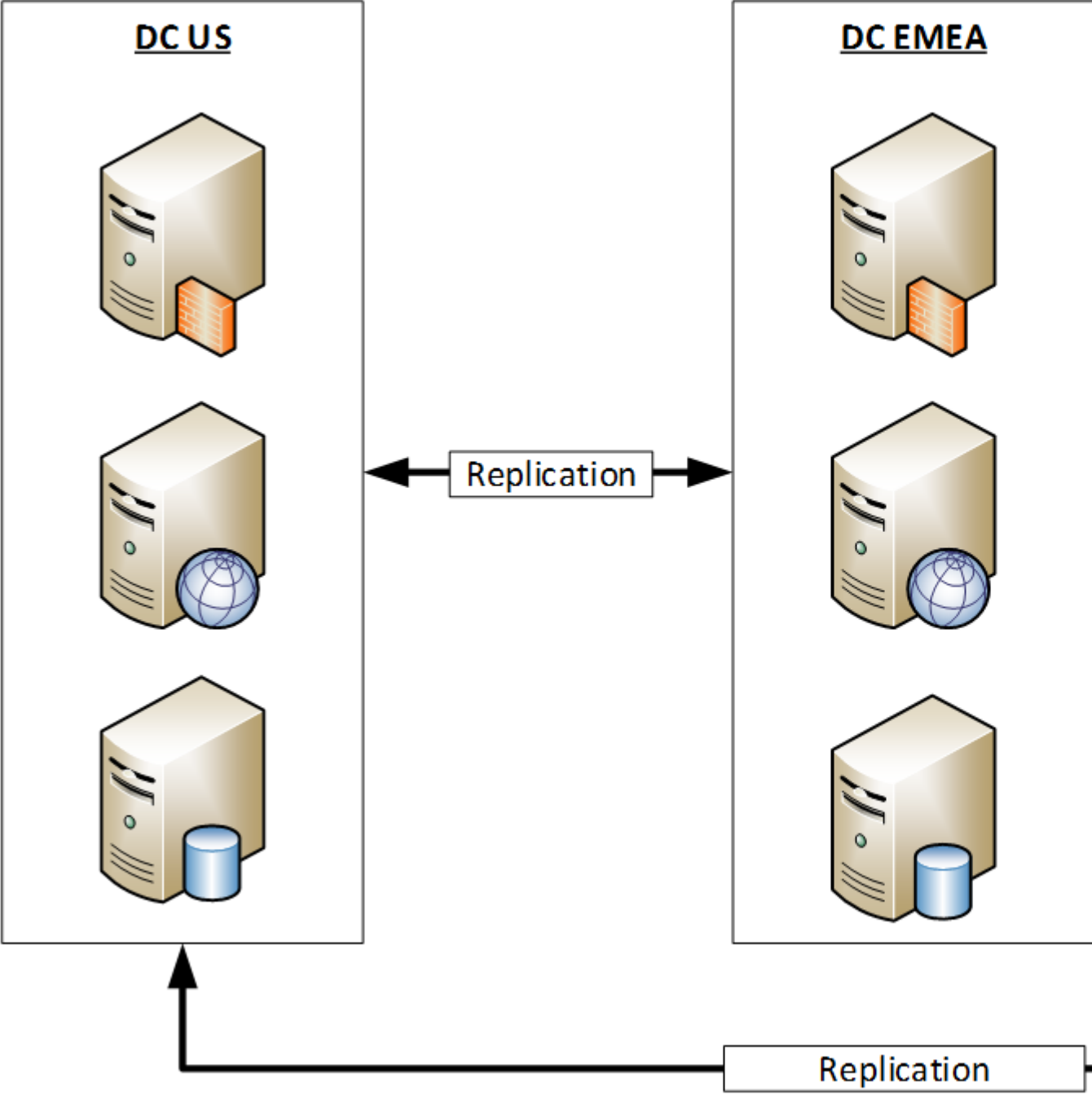

DC EMEA



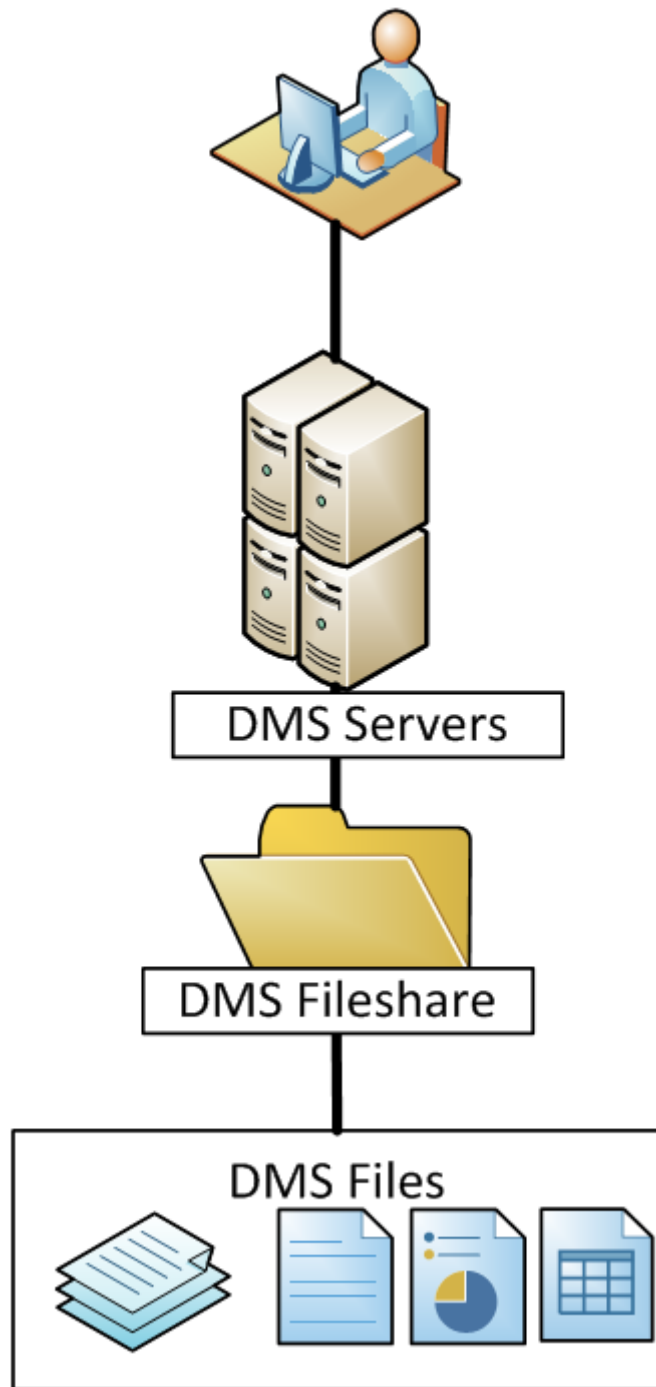

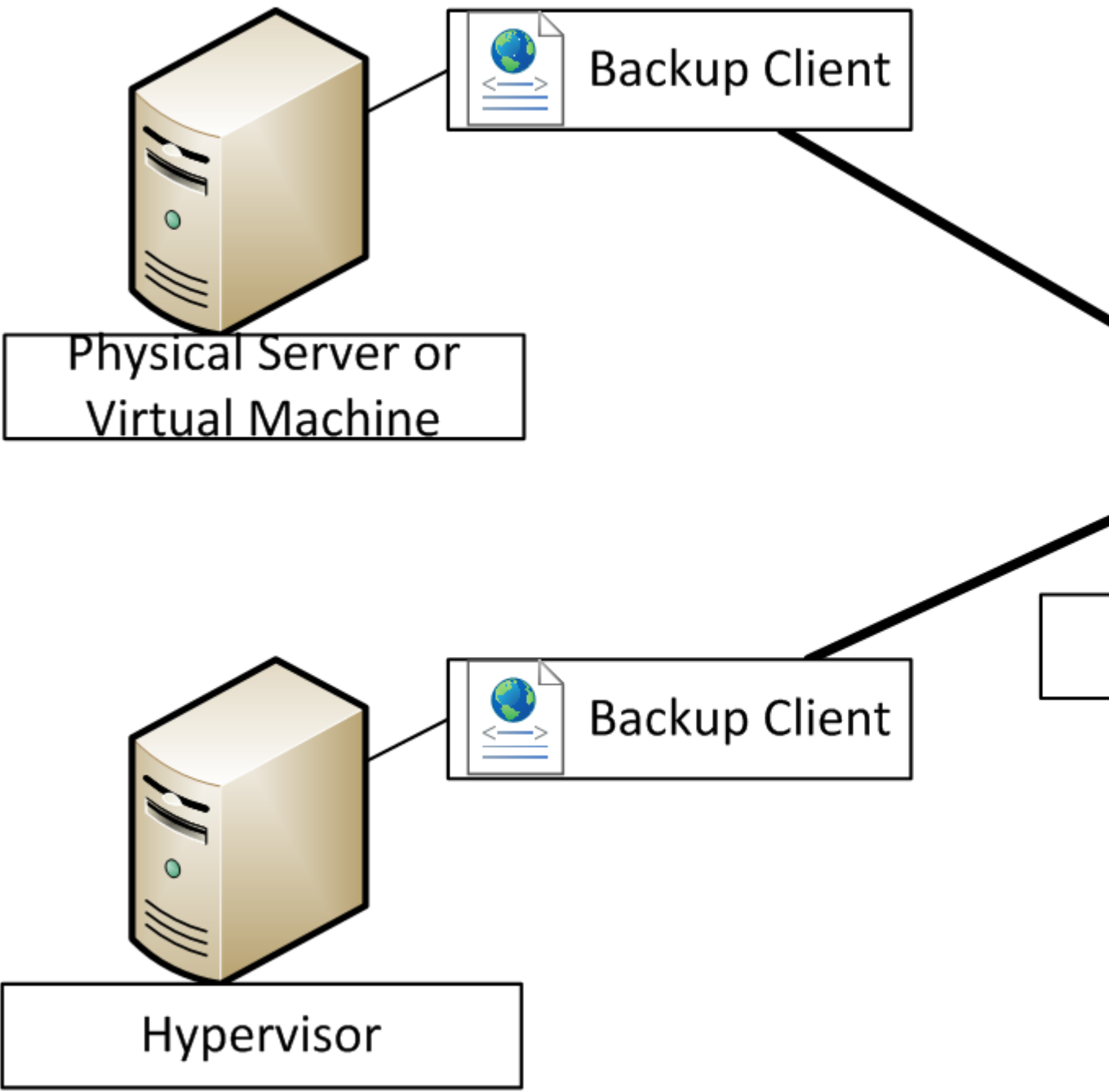

DFS Namespace

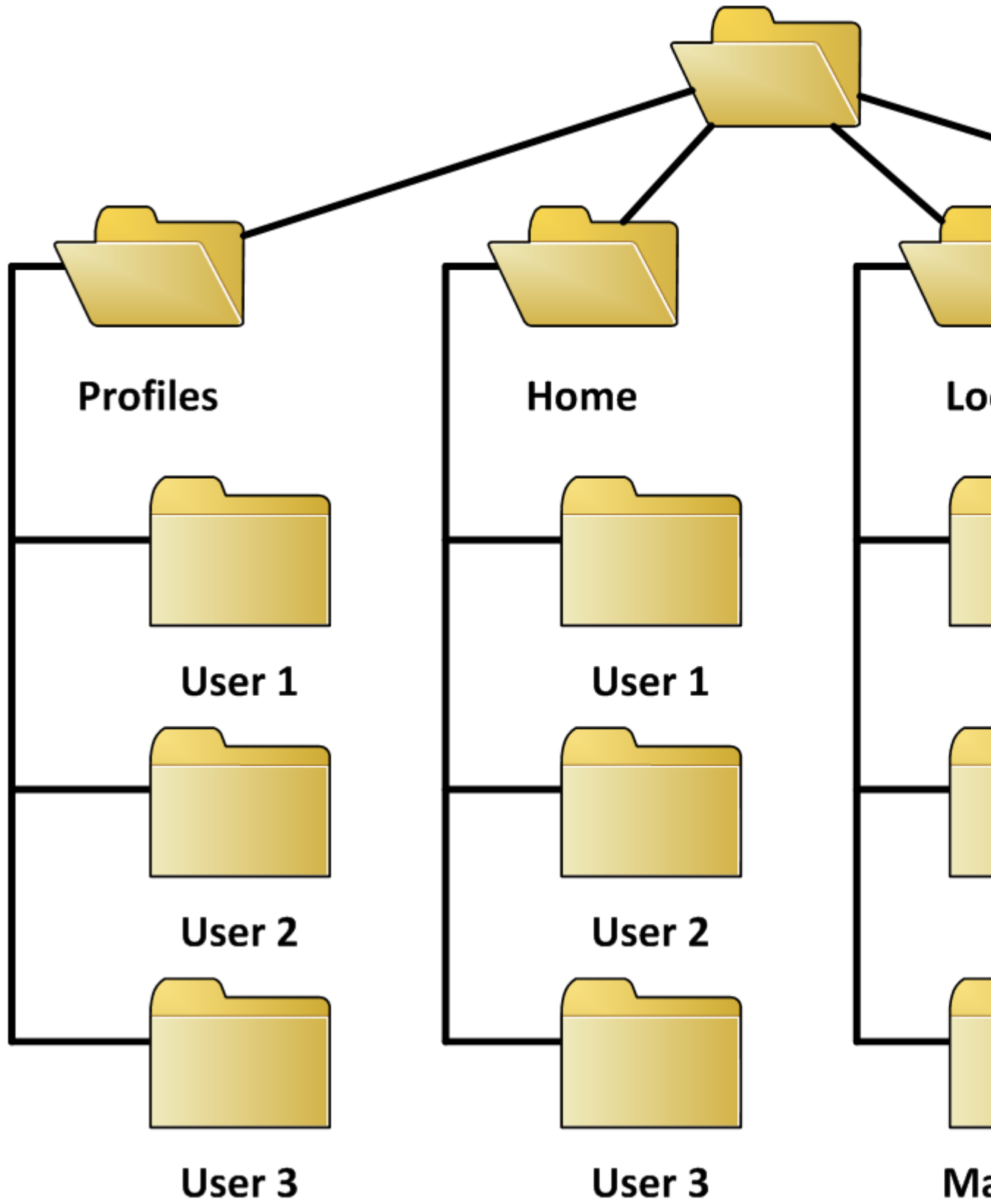

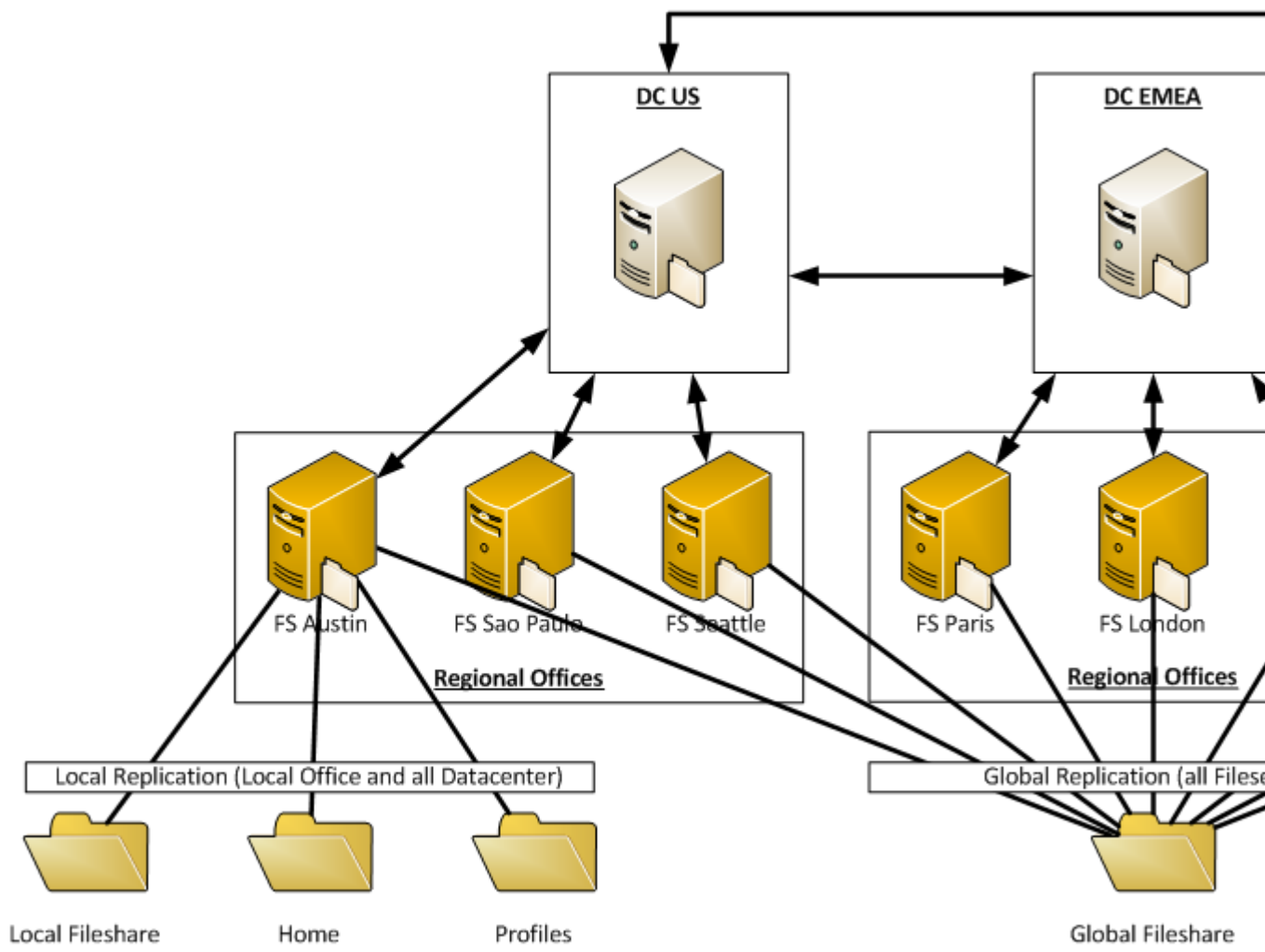

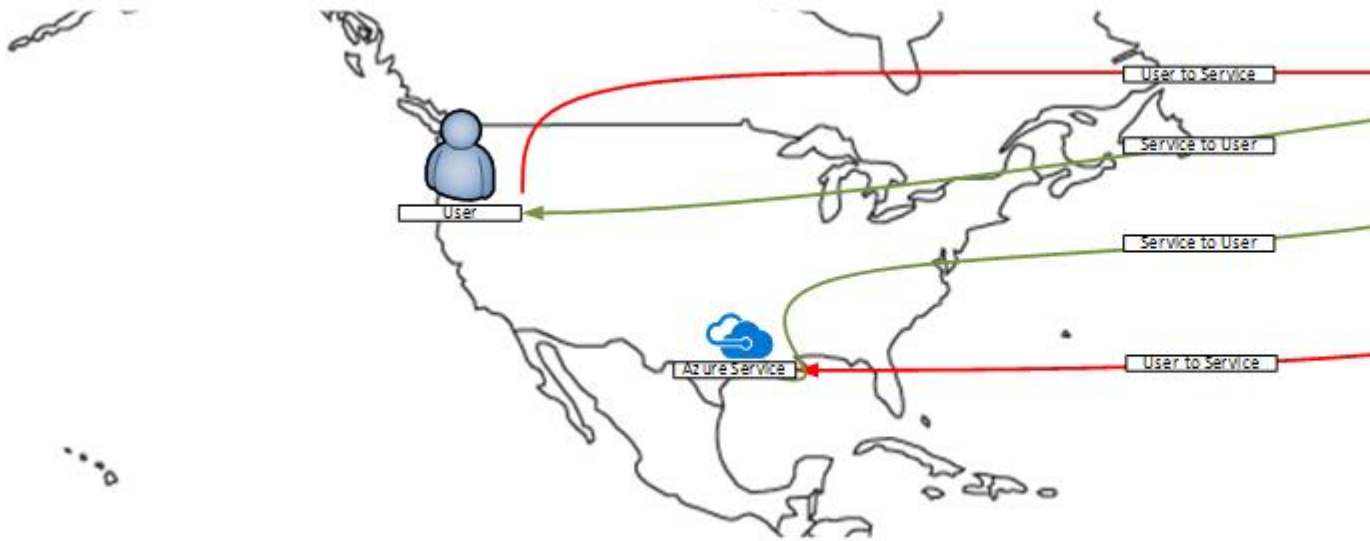

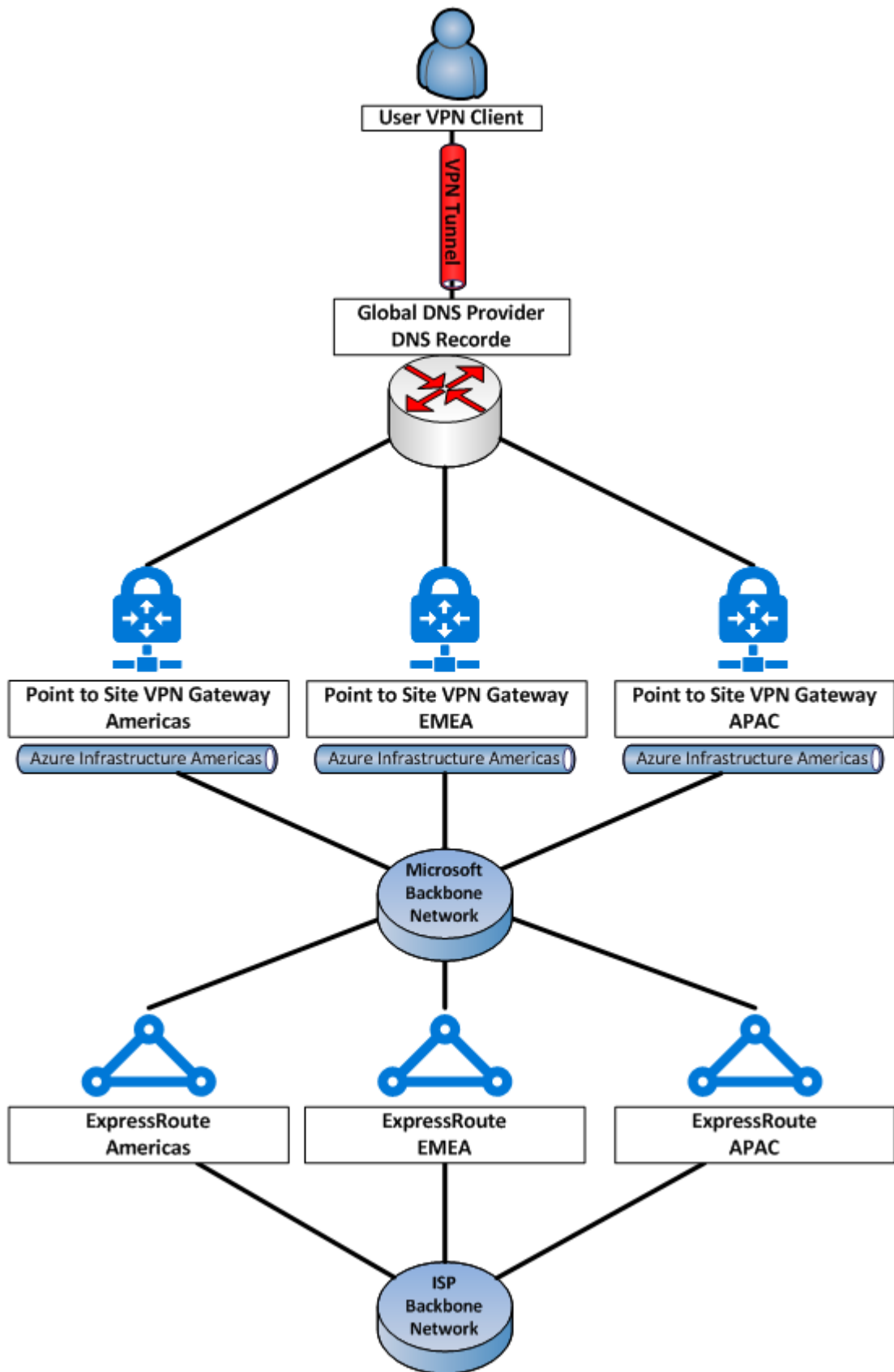

AWE-Demo-GW01 - Point-to-site configuration
Virtual network gateway

Save Discard Download VPN...

Search (Ctrl+/)

- Overview
- Activity log
- Access control (IAM)
- Tags
- Diagnose and solve problems

SETTINGS

- Configuration
- Connections
- Point-to-site configuration 1**

i Add at least one root certificate in order to be able to download the VPN client.

Connection health

| | |
|-----------------|---|
| Connections | 0 |
| Ingress (bytes) | 0 |
| Egress (bytes) | 0 |

Address pool

Root certificates

| NAME | PUBLIC CERTIFICATE DATA | 2 |
|------|-------------------------|-----|
| | | ... |

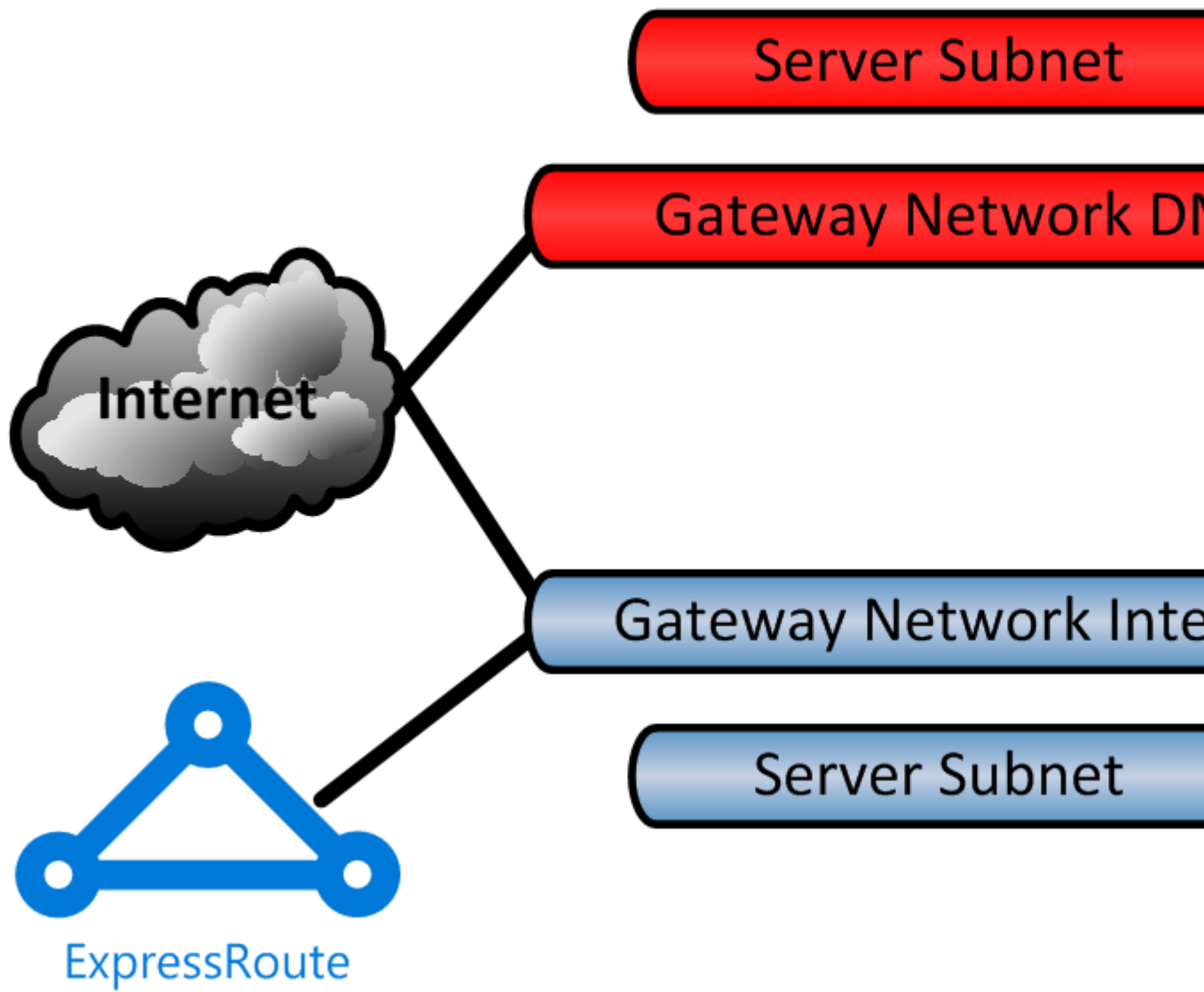

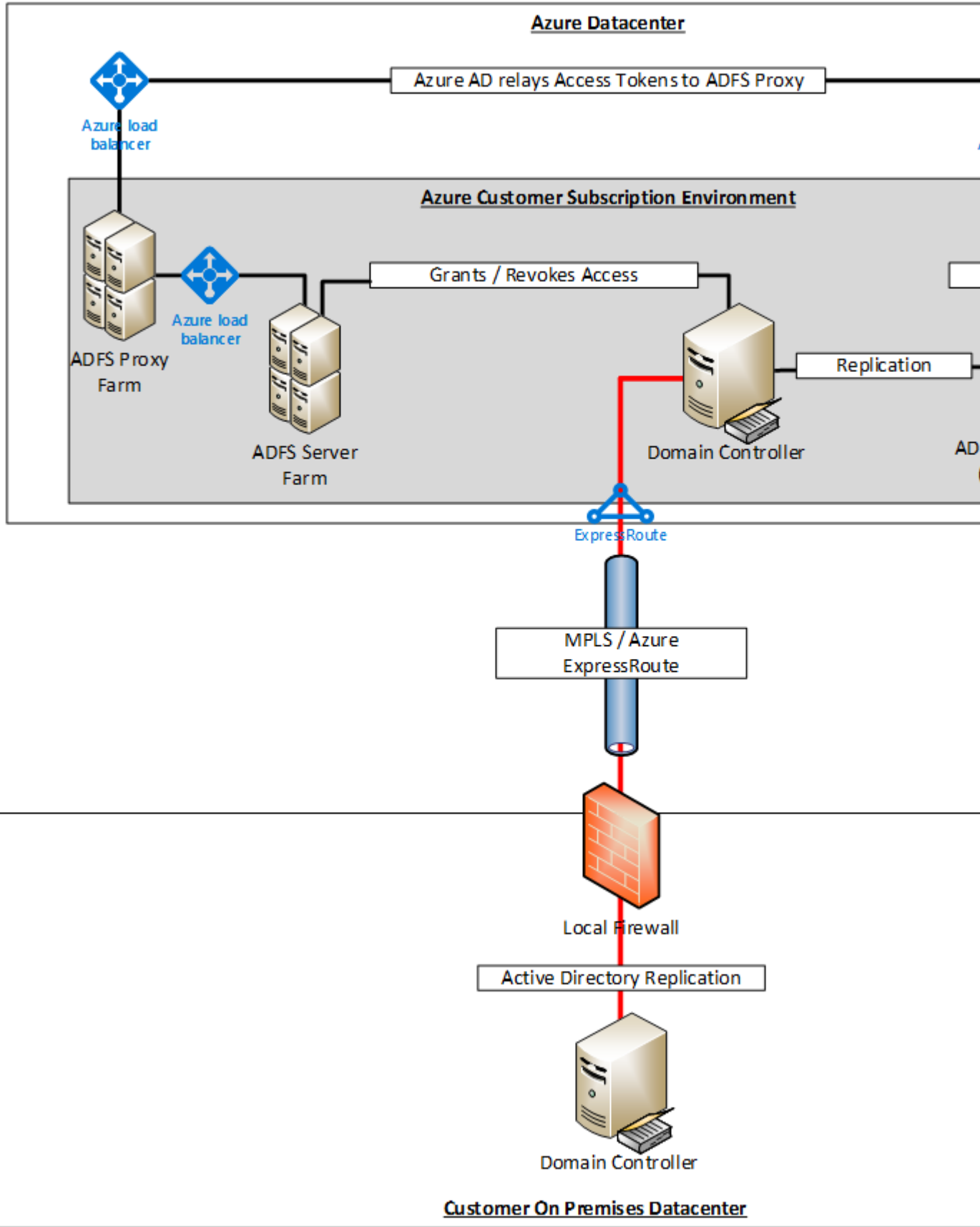



SharePoint admin center

site collections

infopath

user profiles

bcs

term store

records management

search

secure store

apps

sharing

settings

configure hybrid

device access

business connectivity services

[Manage BDC Models and External Content Types](#)

Manage External Content Types that are not restricted to an App. These

connection settings for apps

[Manage connections to online services](#)



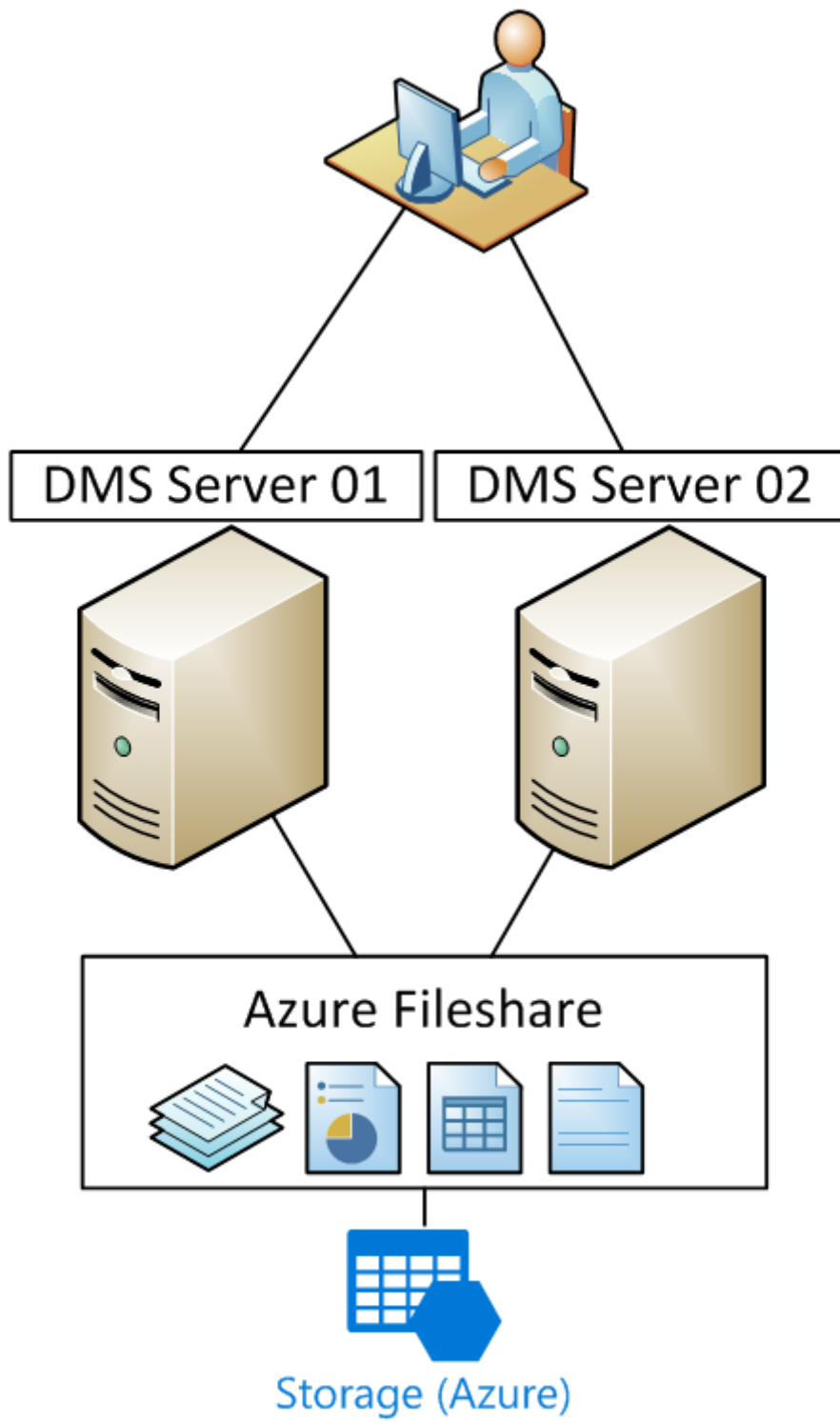

Manage connection settings to online OData services. You can configur

[Manage connections to on-premises services](#)

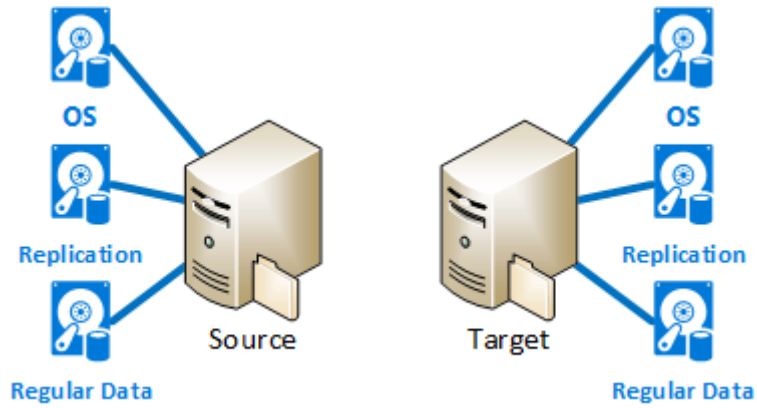
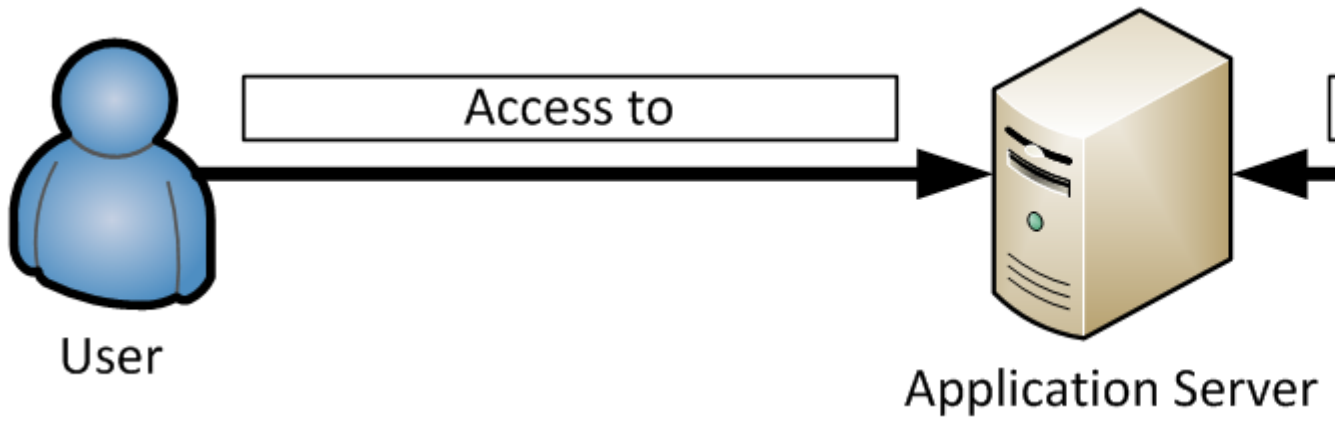
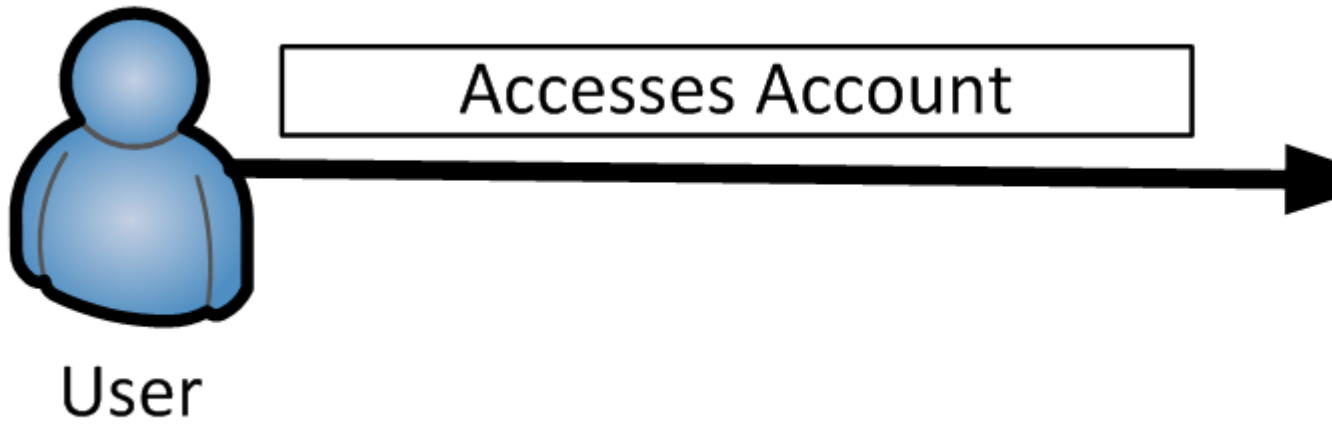
Manage connection settings to OData services that are on-premises. Yo





| | | | | | |
|---|----------------------|--|----------------------|--|----------------------|
| DS1_V2 Standard ★ | | DS2_V2 Standard ★ | | DS3_V2 Standard | |
| 1 | Core | 2 | Cores | 4 | Cores |
| 3.5 | GB | 7 | GB | 14 | GB |
|  2 | Data disks |  4 | Data disks |  8 | Data disks |
|  3200 | Max IOPS |  6400 | Max IOPS |  12800 | Max IOPS |
|  7 GB | Local SSD |  14 GB | Local SSD |  28 GB | Local SSD |
|  | Load balancing |  | Load balancing |  | Load balancing |
|  | Premium disk support |  | Premium disk support |  | Premium disk support |
| 59,60 | | 119,21 | | 238,42 | |
| EUR/MONTH (ESTIMATED) | | EUR/MONTH (ESTIMATED) | | EUR/MONTH (ESTIMATED) | |
| DS4_V2 Standard | | DS5_V2 Standard | | DS11_V2 Standard ★ | |
| 8 | Cores | 16 | Cores | 2 | Cores |
| 28 | GB | 56 | GB | 14 | GB |
|  16 | Data disks |  32 | Data disks |  4 | Data disks |
|  25600 | Max IOPS |  51200 | Max IOPS |  6400 | Max IOPS |
|  56 GB | Local SSD |  112 GB | Local SSD |  28 GB | Local SSD |
|  | Load balancing |  | Load balancing |  | Load balancing |
|  | Premium disk support |  | Premium disk support |  | Premium disk support |

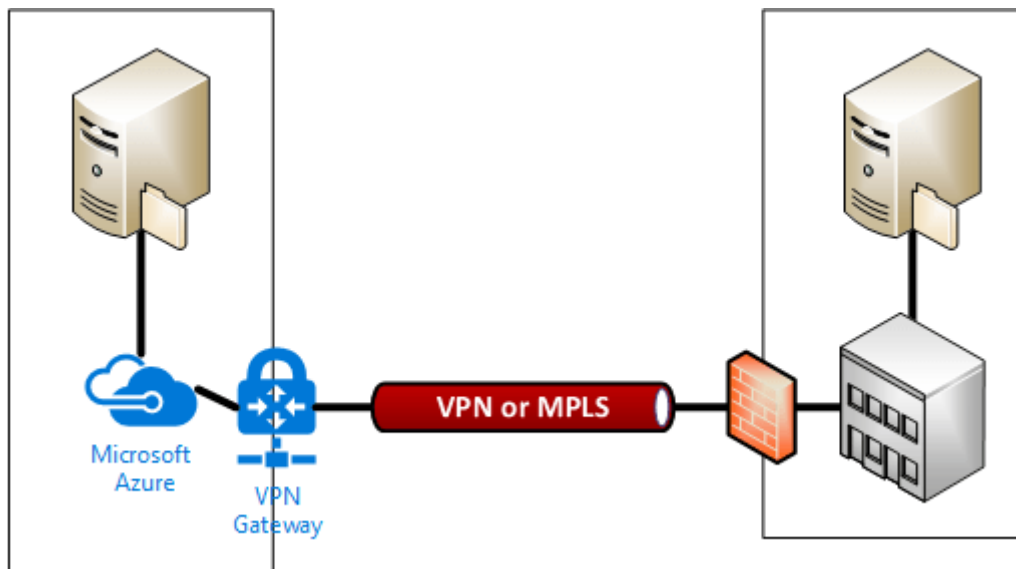

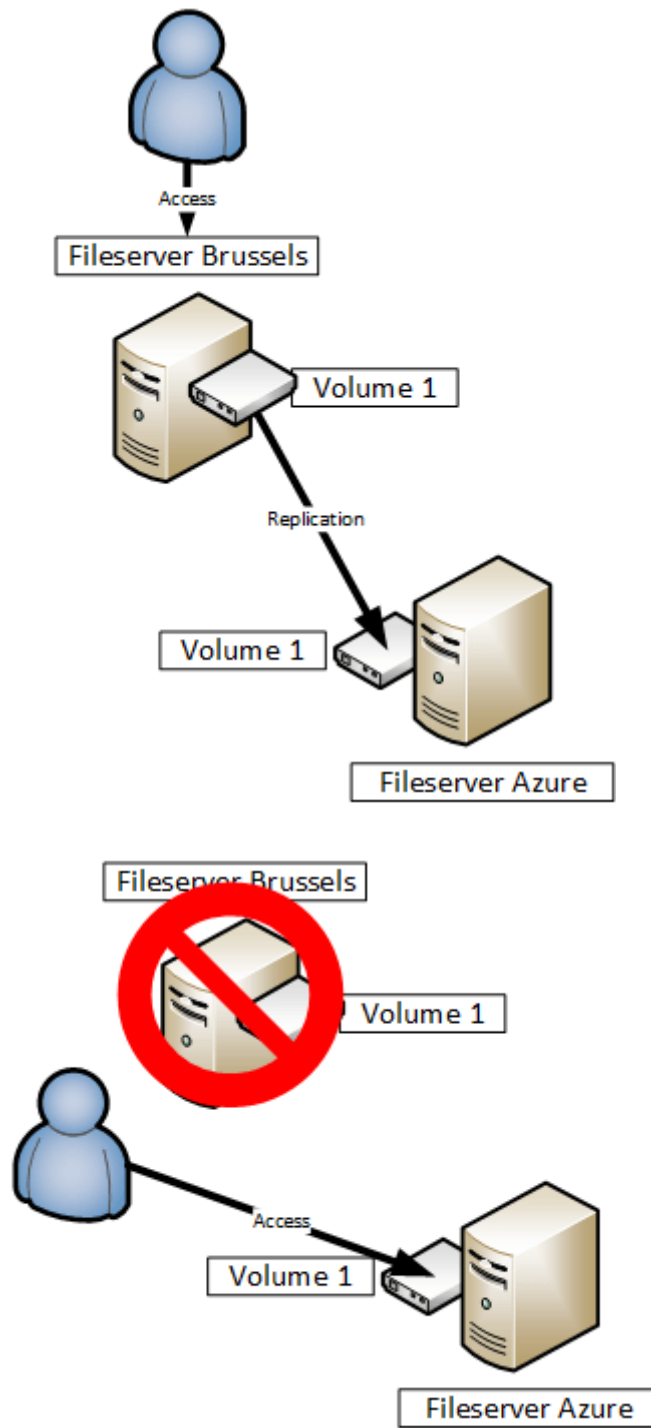

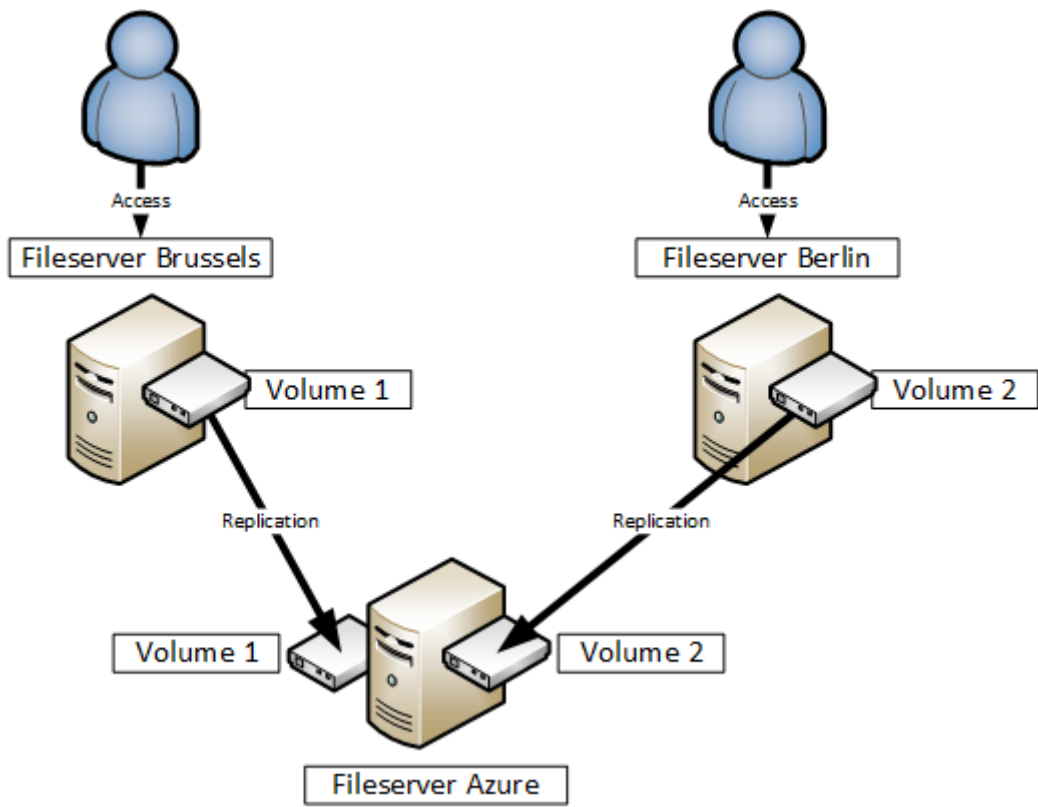















Everything

Filter

TYPO3

Results

| NAME | PUBLISHER | CA |
|--|---------------------------|----|
|  TYPO3 | Bitnami | Co |
|  TYPO3 CMS 6.2 | dkd Internet Service GmbH | W |
|  Hardened Typo3 on CentOS-7.3 | Cognosys Inc. | Co |
|  Hardened Typo3 on Ubuntu 14.04 LTS | Cognosys Inc. | Co |
|  Hardened Typo3 on CentOS-7.3-Professional LIC | Cognosys Inc. | Co |
|  Hardened Typo3 on Ubuntu 14.04 LTS-Pro LIC | Cognosys Inc. | Co |
|  Hardened Typo3 on Ubuntu 14.04 LTS-Ent LIC | Cognosys Inc. | Co |
|  Hardened Typo3 on CentOS-7.3-Enterprise LIC | Cognosys Inc. | Co |
|  Hardened Mautic on Centos 7.3- Enterprise LIC | Cognosys Inc. | Co |
|  Hardened Mautic on Centos 7.3 | Cognosys Inc. | Co |
|  Hardened Mautic on Ubuntu 14.04 LTS | Cognosys Inc. | Co |
|  Hardened Mautic on Centos 7.3-Professional LIC | Cognosys Inc. | Co |
|  Hardened Test Link on Centos | Cognosys Inc. | Co |
|  Hardened Mautic on Ubuntu 14.04 LTS-Ent LIC | Cognosys Inc. | Co |



Recovery Services vaults

DataCenter-Flo

+ Add Columns Refresh

Subscriptions: All 2 selected – Don't see a subscription? [Switch directories](#)

Filter by name...

All subscriptions

1 items

NAME

test

Backup

1 Backup goal
Select

2 Backup policy
Select

3 Items to backup
Select

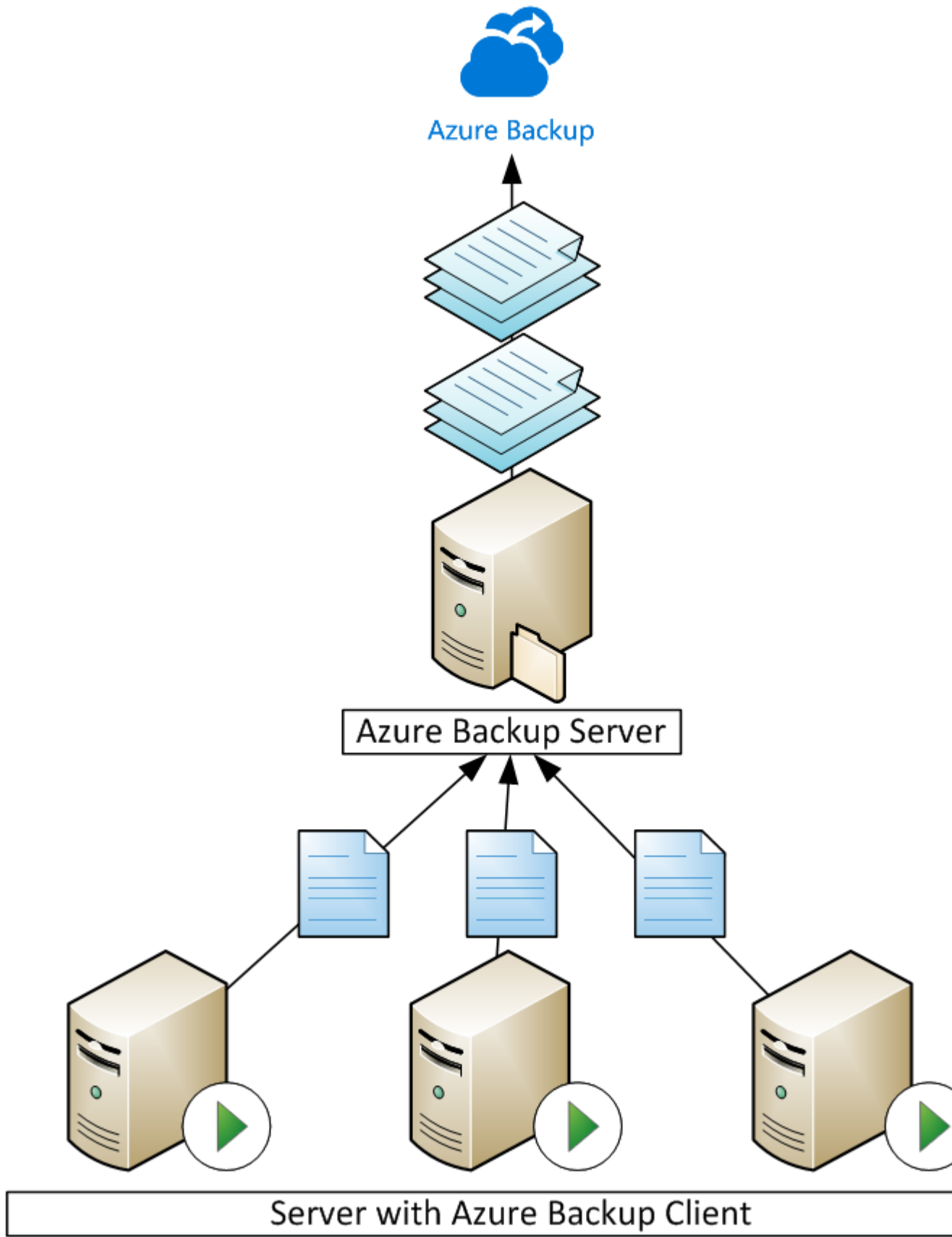

Products

Featured

Compute

Networking

Storage

Web + Mobile

Databases

Intelligence + Analytics

Internet of Things

Enterprise Integration

Security + Identity

Developer Tools

Monitoring + Management



SQL Database

Managed relational SQL Database-as-a-service



SQL Data Warehouse

Elastic data warehouse-as-a-service with enterprise-class



SQL Server Stretch Database

Dynamically stretch on-premises SQL Server databases



DocumentDB

Managed NoSQL document database-as-a-service



Storage

Durable, highly available, and massively scalable cloud



Redis Cache

Access to a secure, dedicated cache for your Azure app



Data Factory

Orchestrate and manage data transformation and mov



Virtual Machine - Domaincontroller



REGION:

West Europe

TYPE:

Windows



ADD MANAGED DISKS

PRICING TIER:

Standard



NOTE: Save up to 40 percent on Windows Server virtual machines using your existing licenses with Software Assurance. [Learn more](#)

INSTANCE SIZE:

A4 v2: 4 cores, 8 GB RAM, 40 GB disk, €0.231/hr

1

Virtual Machines

×

744

Hours

= €171.91/MO

Managed disks

DISK TYPE:

S4 - 32 GB

Standard Managed disk instances have an additional cost of €0.0030 per 100,000 transactions.

1

Disks

×

€0.65

Per month

= €0.65/MO

Sub-total €172.56/MO

Your estimate

1

| | |
|-------------------------|---------|
| Euro (€) | |
| VPN Gateway | €25.89 |
| Virtual Machine - Do... | €172.56 |
| Virtual Machine - AD... | €39.55 |
| Virtual Machine - AD... | €39.55 |
| Virtual Machine - AD... | €41.43 |
| Backup | €0.00 |
| Support Options | €0.00 |

ESTIMATED MONTHLY COST

€318.97

Purchase options >

Export estimate

Prices are estimates and are not intended as actual price quotes.

1

| Service type | Custom name | Region | Description | Estimated Cost |
|--|------------------------------------|-------------|--|------------------|
| VPN Gateway | VPN Gateway | West Europe | static-dynamic tier, 744 gateway hour(s), 50 GB outbound vpn | €25.89 |
| Virtual Machines | Virtual Machine - Domaincontroller | West Europe | 1 Standard virtual machine(s), A4 v2 (4 cores, 8 GB RAM, 40 GB disk size, 744 hours, Managed disks: standard-s4 Disk type with 1 disks | €172.56 |
| Virtual Machines | Virtual Machine - AD Connect | West Europe | 1 Standard virtual machine(s), A1 v2 (1 cores, 2 GB RAM, 10 GB disk size, 744 hours, Managed disks: standard-s4 Disk type with 1 disks | €39.55 |
| Virtual Machines | Virtual Machine - ADFS Server | West Europe | 1 Standard virtual machine(s), A1 v2 (1 cores, 2 GB RAM, 10 GB disk size, 744 hours, Managed disks: standard-s4 Disk type with 1 disks | €39.55 |
| Virtual Machines | Virtual Machine - ADFS Proxy | West US | 1 Standard virtual machine(s), A1 v2 (1 cores, 2 GB RAM, 10 GB disk size, 744 hours, Managed disks: standard-s4 Disk type with 1 disks | €41.43 |
| Backup | Backup | East US | 1 instance(s), 0 GB, 0 GB LRS of storage | €0.00 |
| Support | | | Support | €0.00 |
| Monthly Total | | | | €318.97 |
| Annual Total | | | | €3,827.67 |
| Disclaimer | | | | |
| All prices shown are in Euro (€). This is a summary estimate, not a quote. For up to date pricing information please visit https://azure.microsoft.com/pricing/calculator/ . This estimate was created at 4/7/2017 6:49:39 PM UTC. | | | | |

2

Total Cost of Ownership (TCO) Calculator ^{PREVIEW}

Inputs & Assumptions

Inputs

Assumptions

Region

Currency

Compute

Manual Input Bulk Input

| | | | | | |
|---|---|--|---|---|---|
| Environment <input type="text" value="Physical Servers"/> | Operating system <input type="text" value="Windows"/> | Server count <input type="text" value="20"/> | Proc(s) per server <input type="text" value="4"/> | Core(s) per proc <input type="text" value="4"/> | RAM (GB) <input type="text" value="112"/> |
|---|---|--|---|---|---|

Storage

| | | | | | |
|---|--|---|---|--|-------------------------------------|
| Storage type <input type="text" value="DAS/SAN"/> | Disk Type <input type="text" value="HDD"/> | Capacity <input type="text" value="1"/> <input type="text" value="TB"/> | Backup <input type="text" value="0"/> <input type="text" value="TB"/> | Archive <input type="text" value="0"/> <input type="text" value="TB"/> | <input type="checkbox"/> Enable GRS |
|---|--|---|---|--|-------------------------------------|

Networking

Outbound bandwidth (GB)/Month



Inputs & Assumptions

[Export](#) | [Print](#) | [Get started with Azure](#)

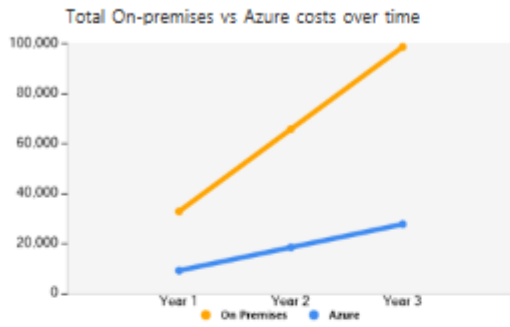

Your estimated cost savings could be as much as **\$71,072 (72%)** over 3 years with Microsoft Azure

Estimated cost savings over 3 years by category

| | |
|-------------|----------|
| Compute | \$43,459 |
| Data center | \$9,169 |
| Networking | \$19,338 |
| Storage | \$410 |
| IT labor | \$1,514 |

On-premises costs breakdown summary

| Category | Costs |
|--------------|-----------------|
| Compute | \$69,696 |
| Hardware | \$55,078 |
| Software | \$9,261 |
| Electricity | \$5,357 |
| Data center | \$9,169 |
| Networking | \$19,338 |
| Storage | \$1,331 |
| IT labor | \$2,429 |
| Total | \$98,906 |

Azure costs breakdown summary

| Category | Web direct costs | CPP costs with EA pricing |
|--------------|------------------|---------------------------|
| Compute | \$41,654 | \$26,237 |
| Data center | \$0 | \$0 |
| Networking | \$0 | \$0 |
| Storage | \$921 | \$921 |
| IT labor | \$915 | \$915 |
| Total | \$43,491 | \$27,834 |

Estimated On-premises costs (3 Years)

| | |
|---|-----------------|
| Compute costs | \$69,696 |
| Data center costs | \$9,169 |
| Networking costs | \$19,338 |
| Storage costs | \$1,331 |
| IT labor costs | \$2,429 |
| Total on-premises costs over 3 years | \$98,906 |

Estimated Azure costs (3 Years)

| | |
|-------------------------------------|-----------------|
| Azure compute costs | \$26,237 |
| Azure data center costs | \$0 |
| Azure networking costs | \$0 |
| Azure storage costs | \$921 |
| IT labor costs | \$915 |
| Total Azure web direct costs | \$43,491 |