

Chapter 1: The Nuts and Bolts of Neural Networks

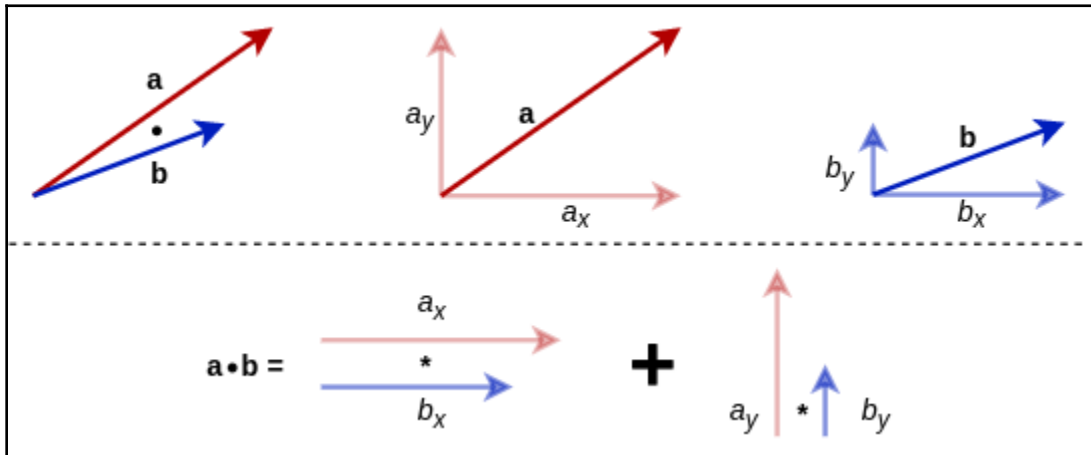

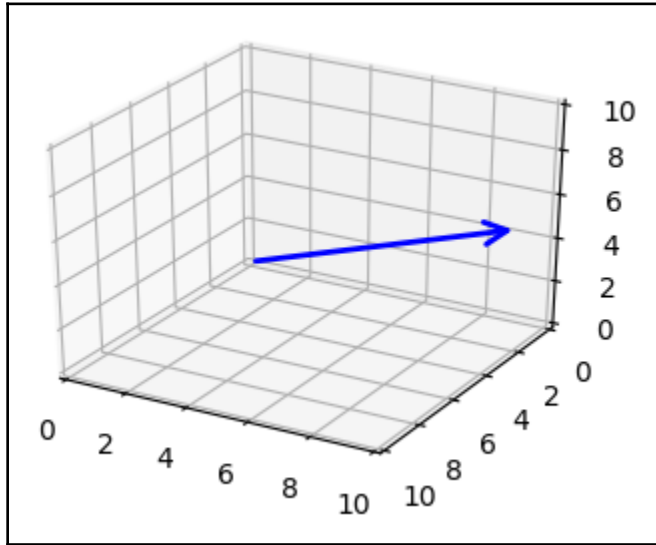

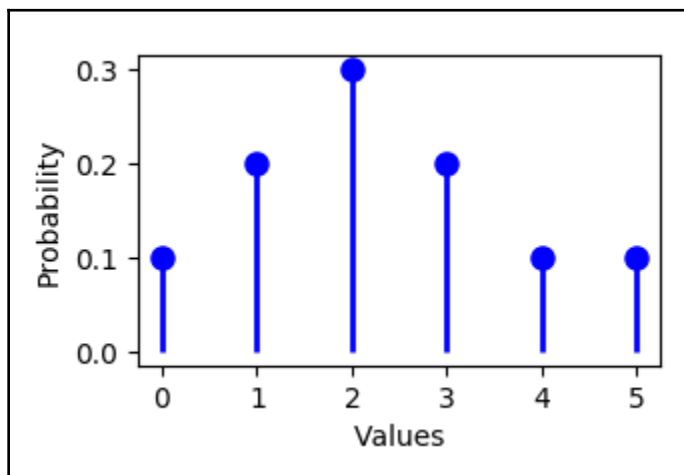

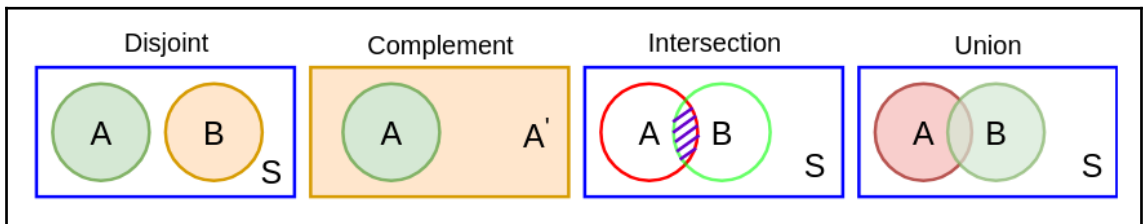
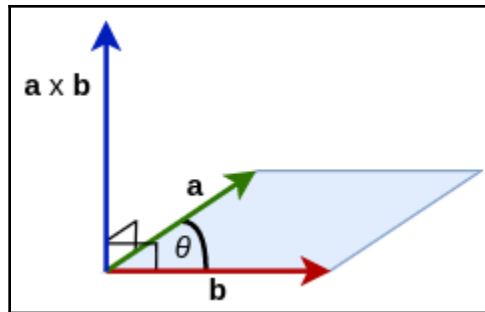
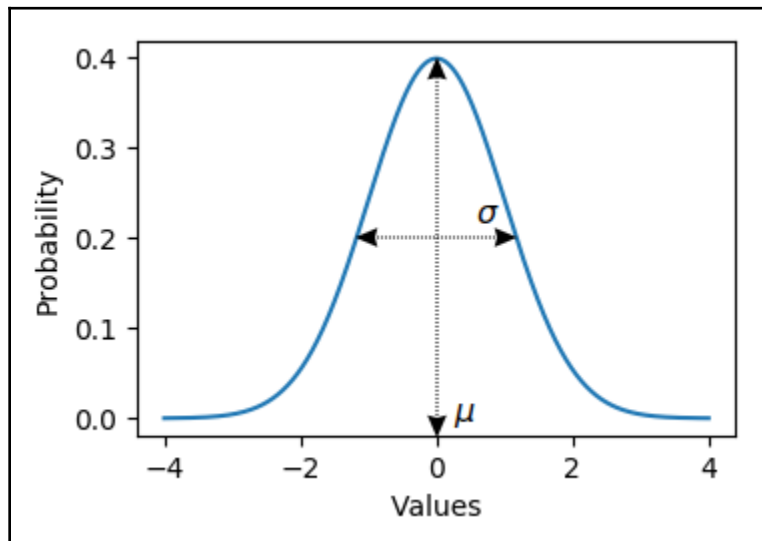
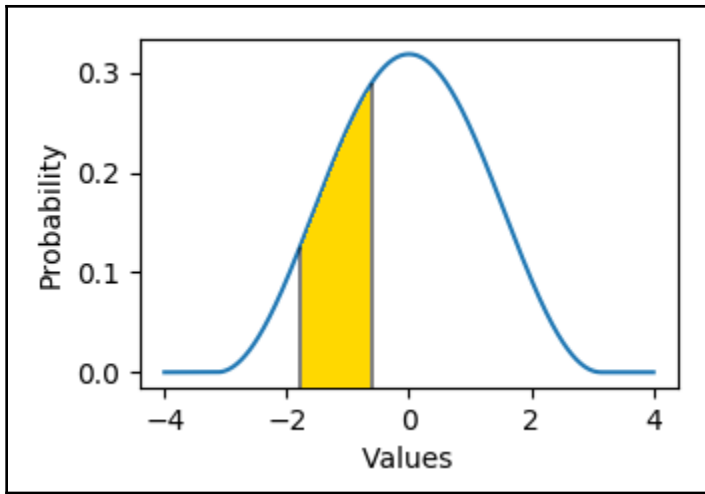
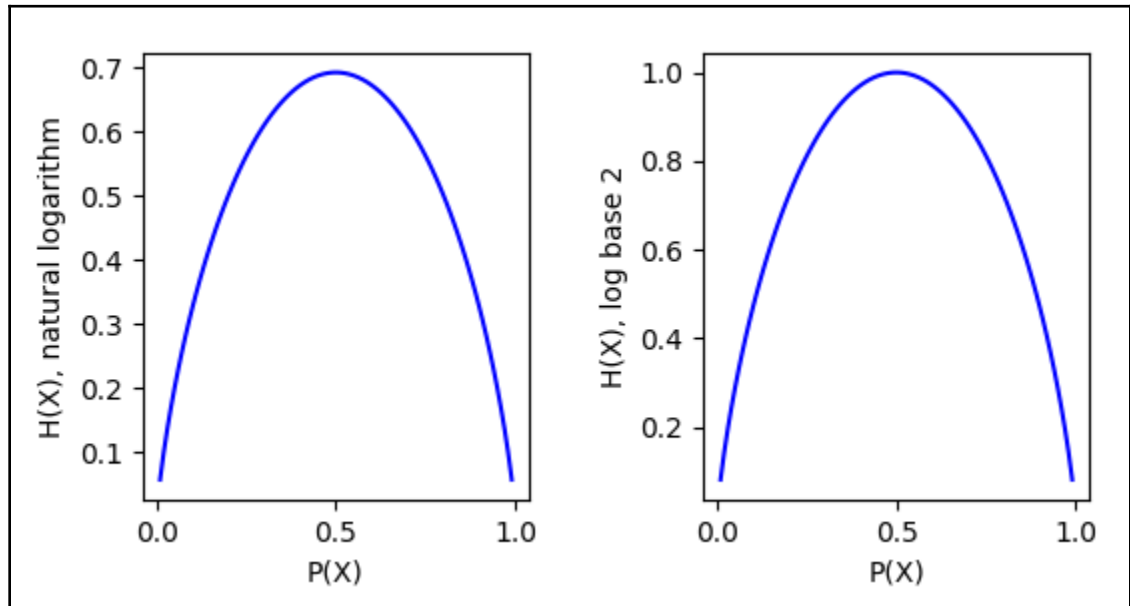
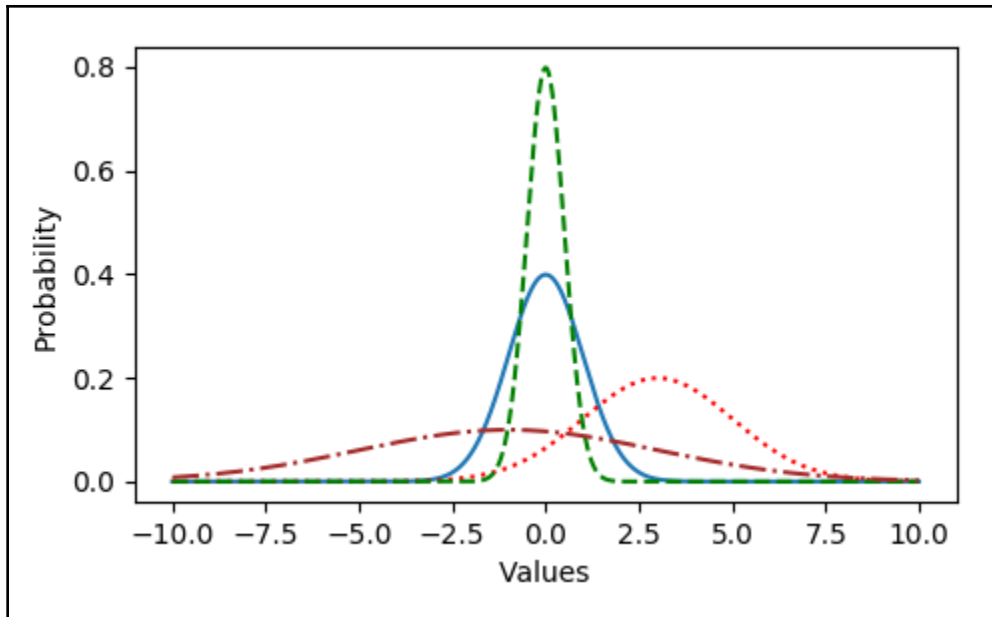

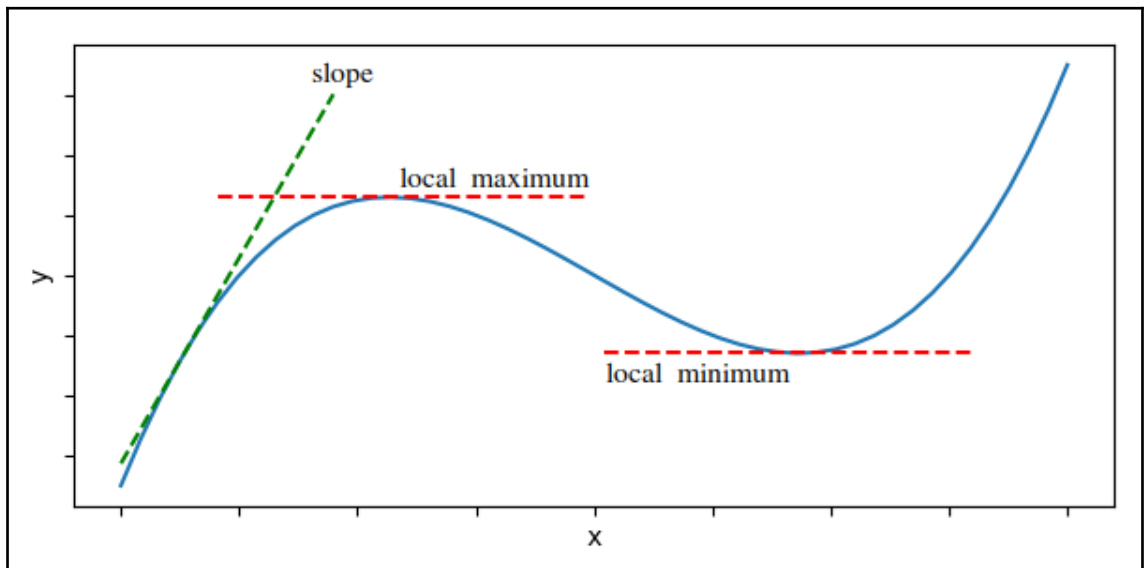
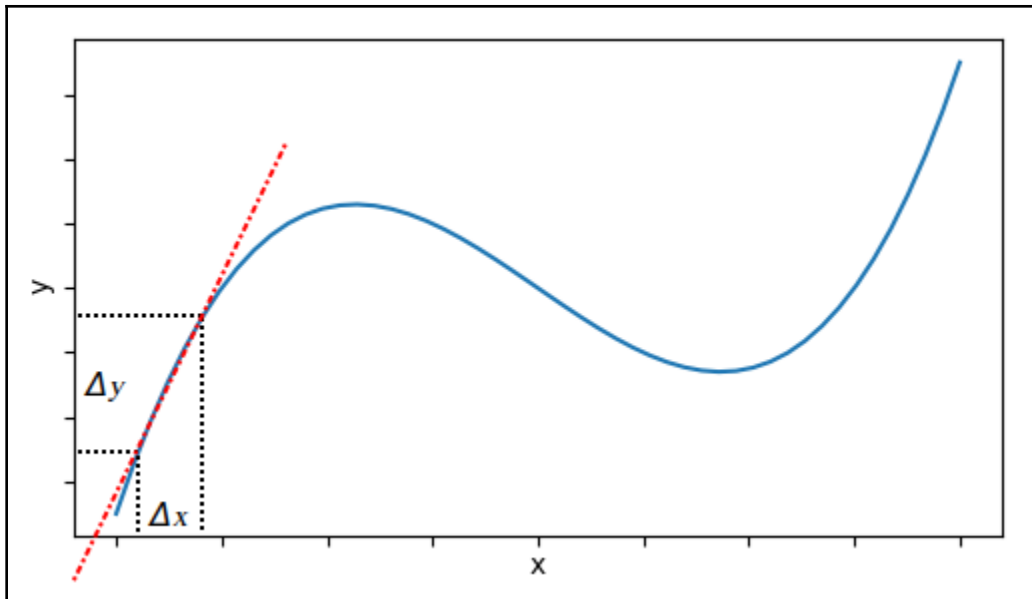

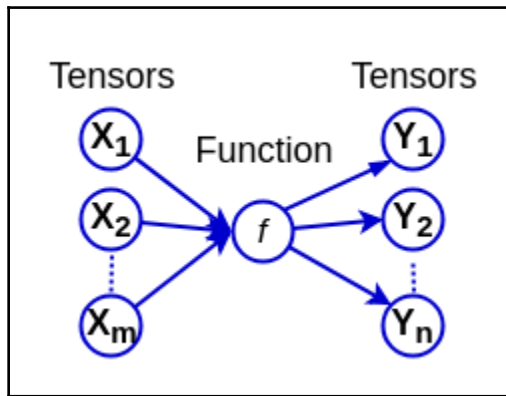
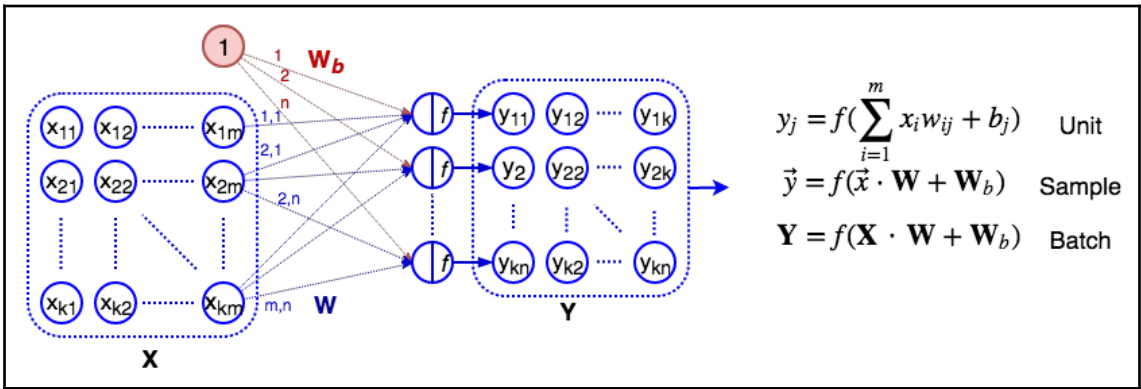
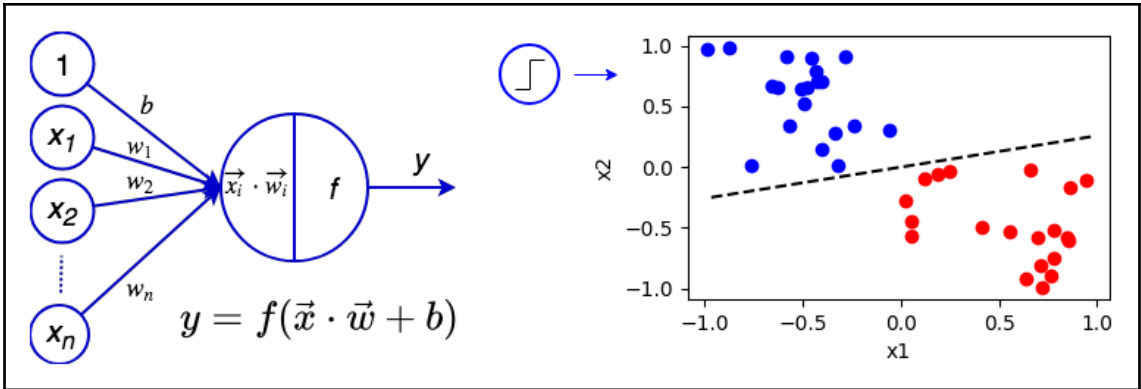

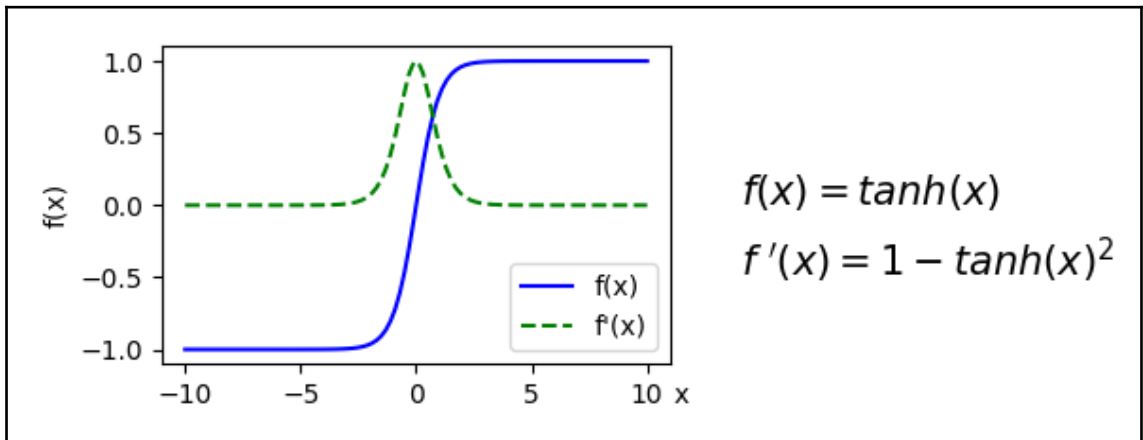
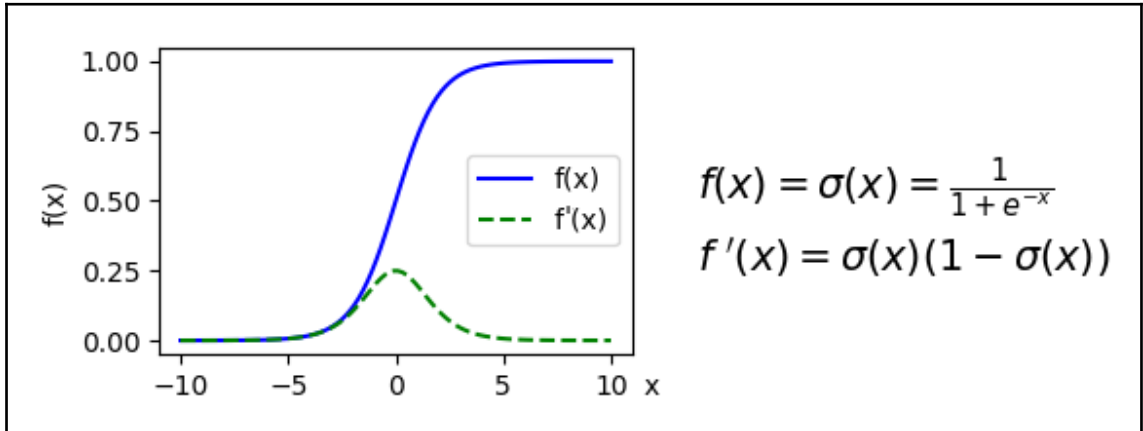
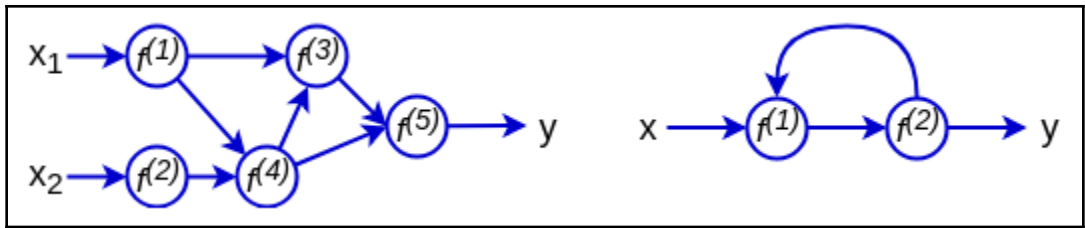

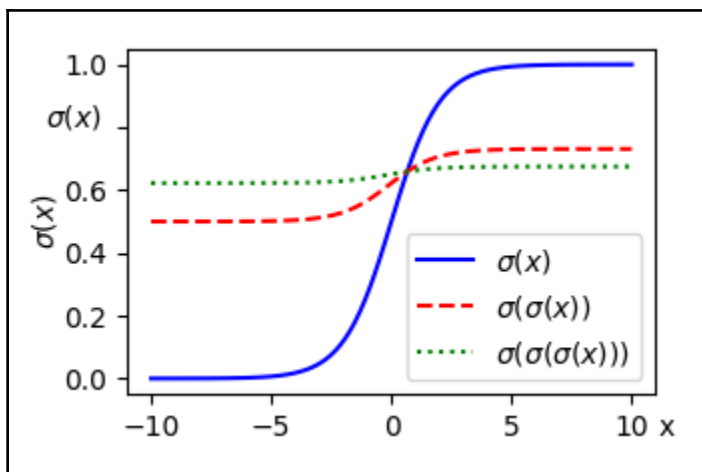
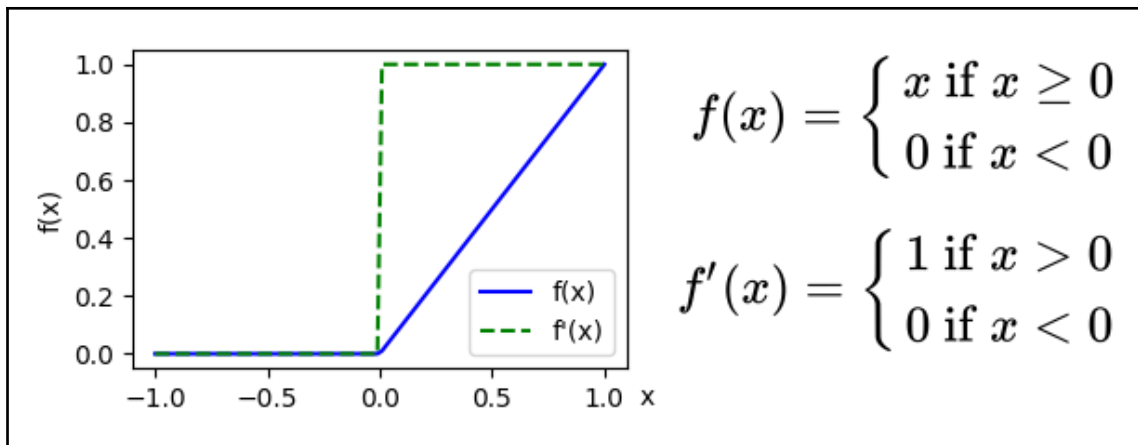

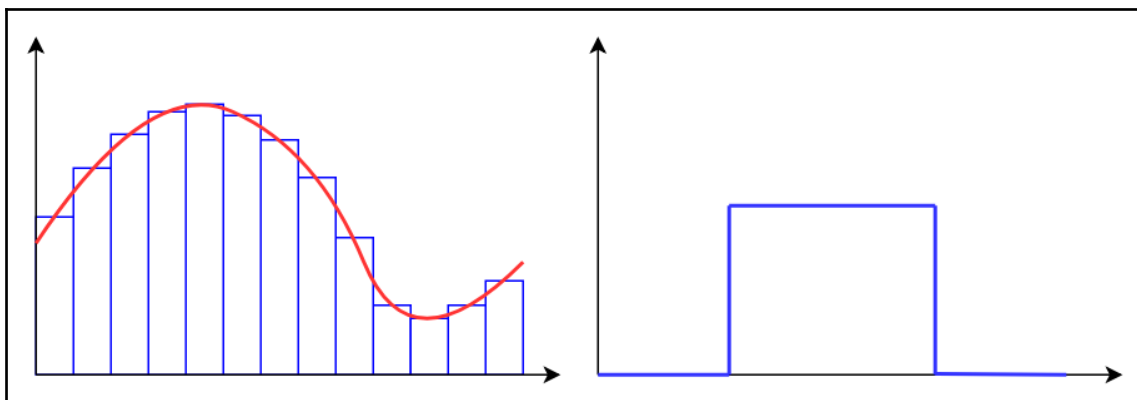
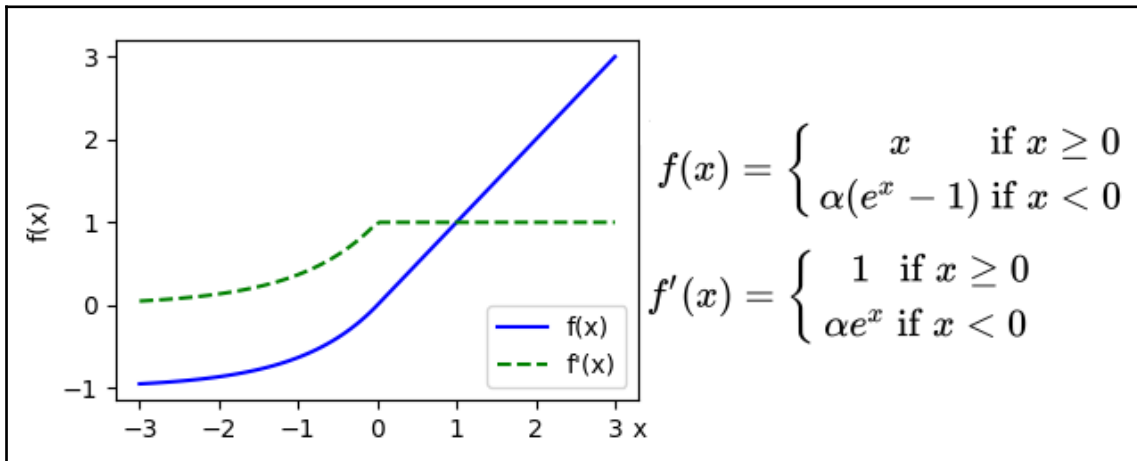
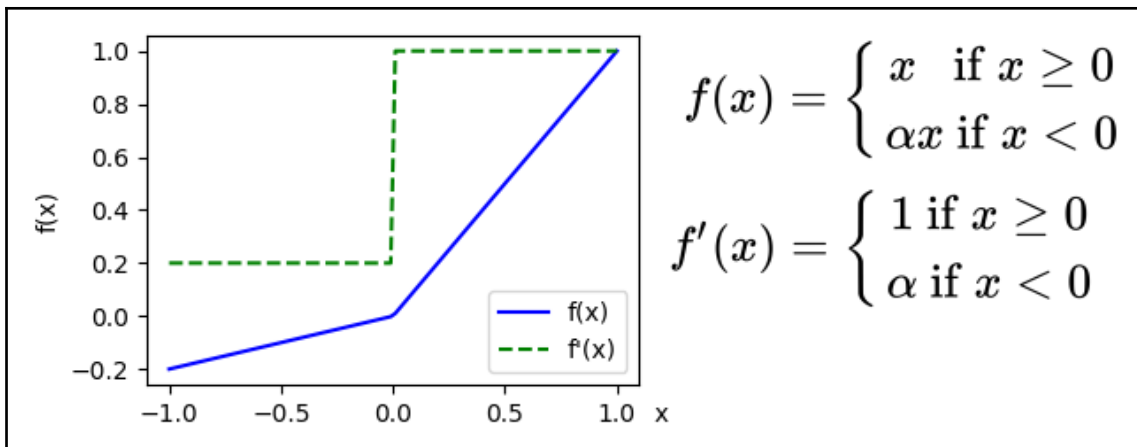

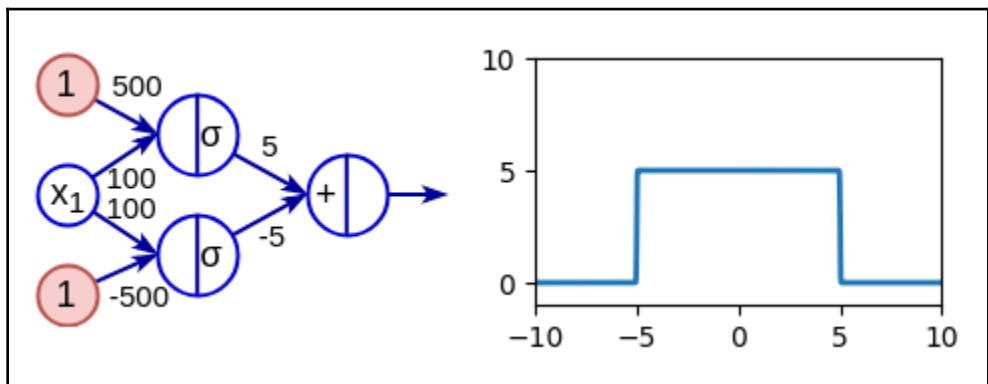
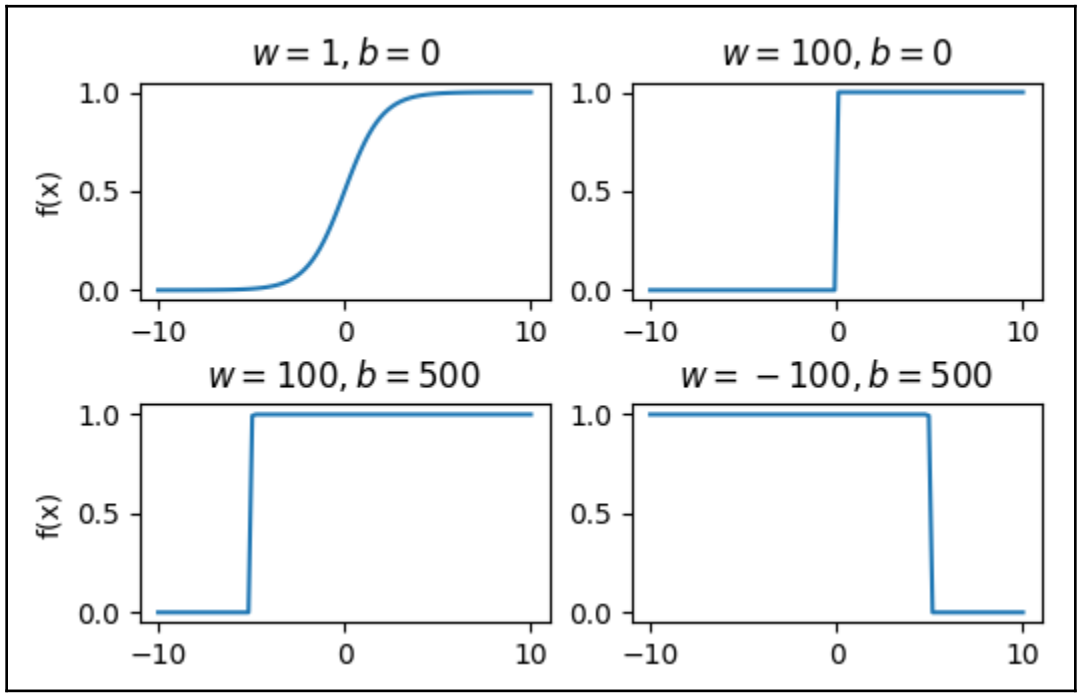
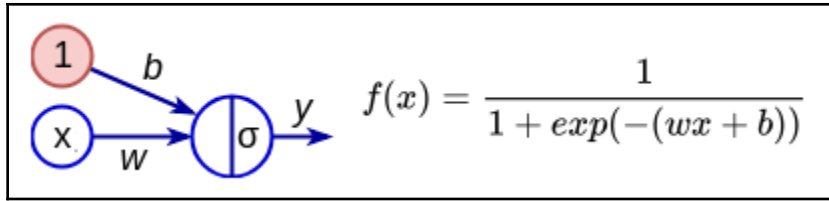

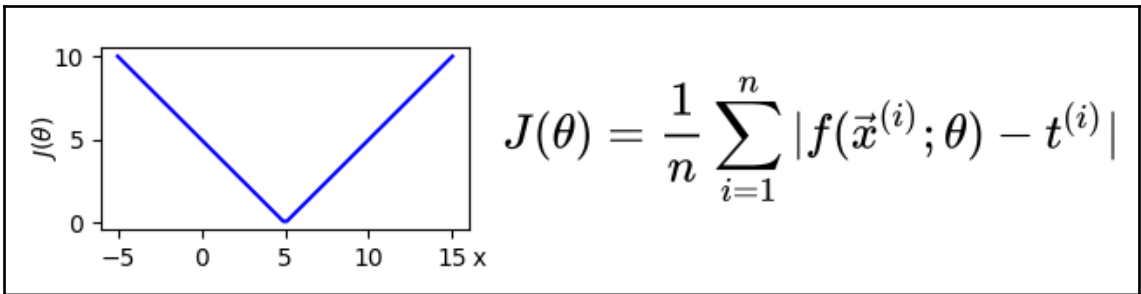
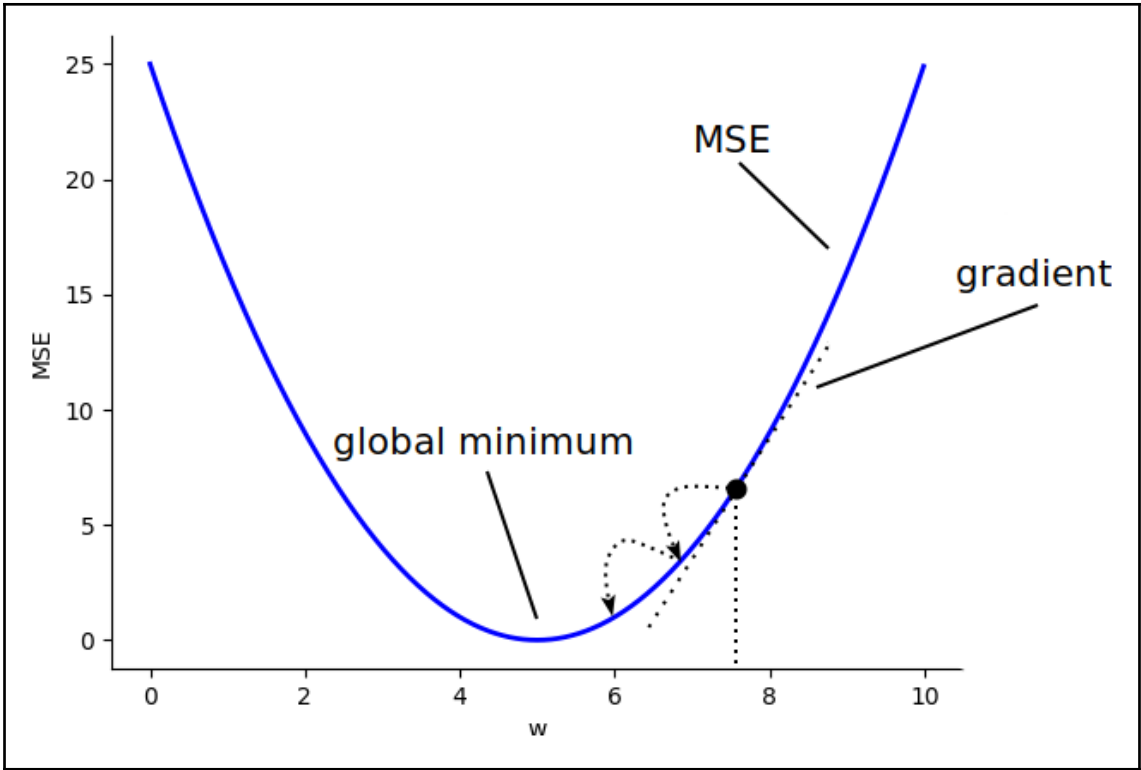

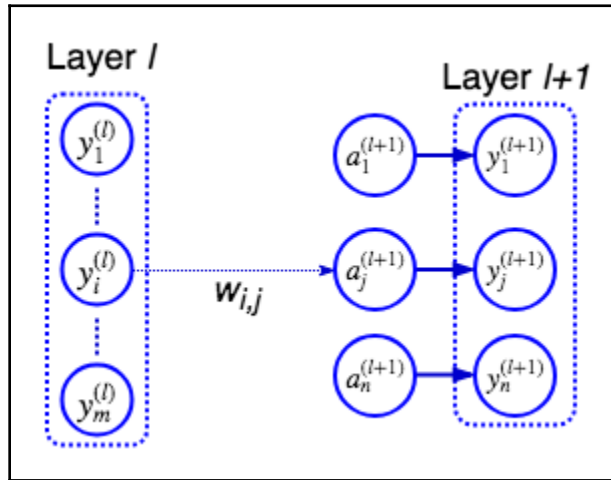
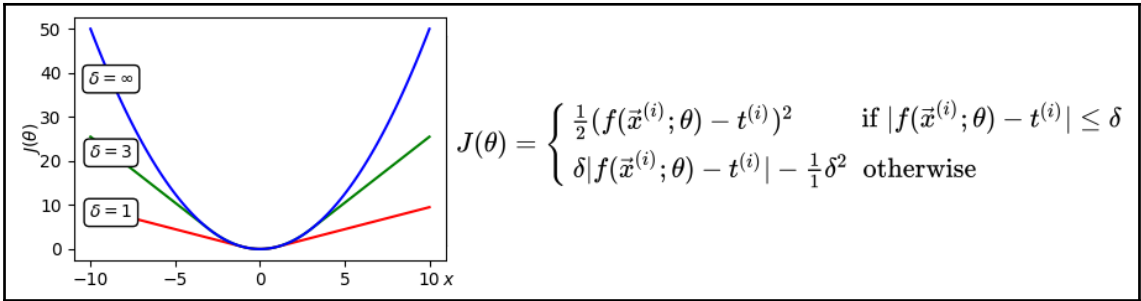

Chapter 2: Understanding Convolutional Networks

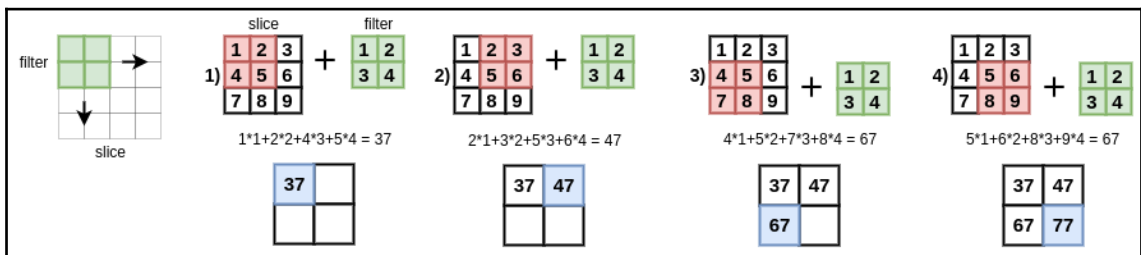
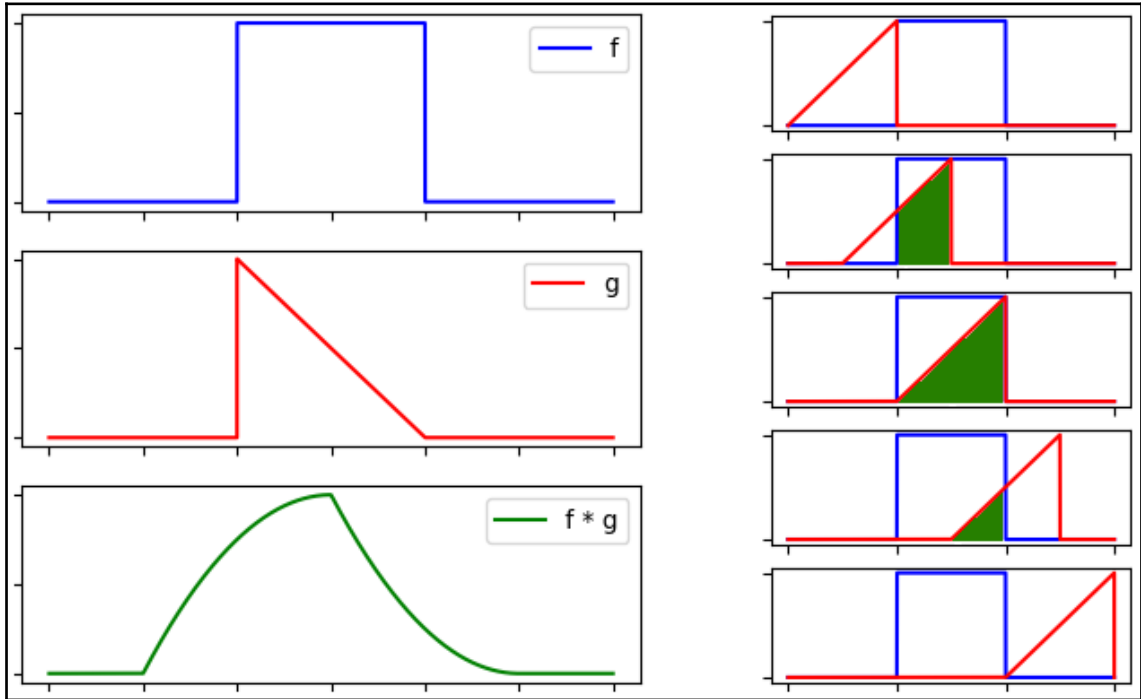

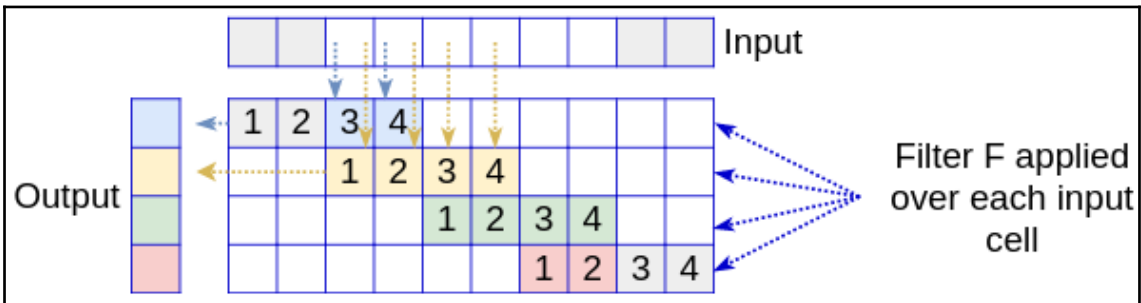
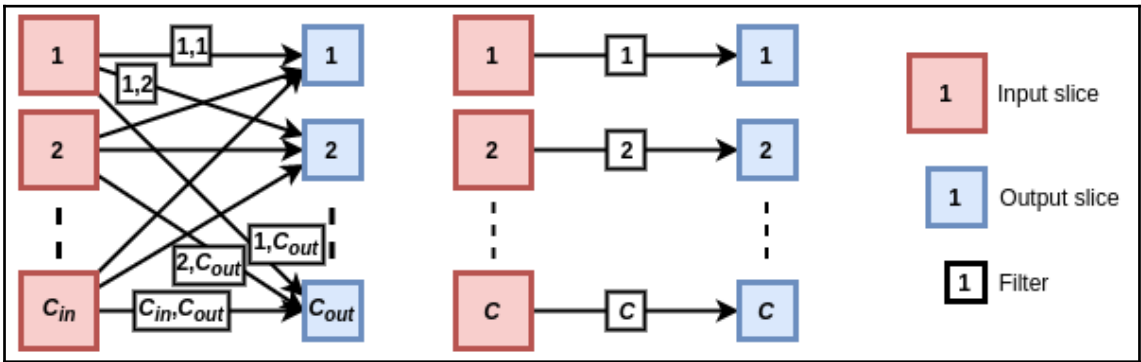
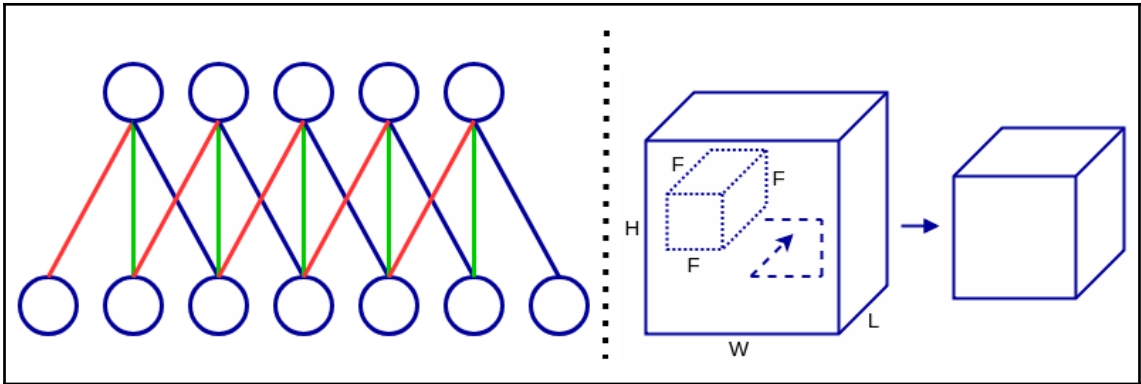

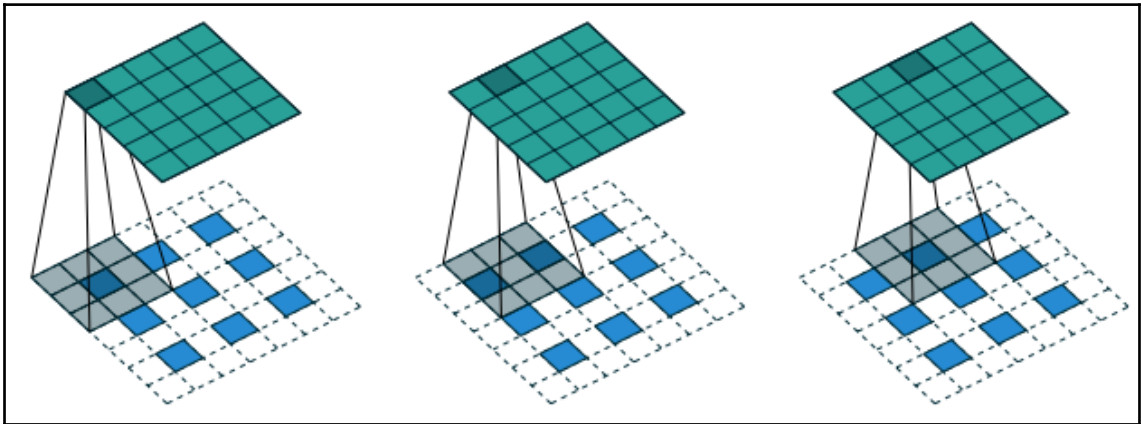
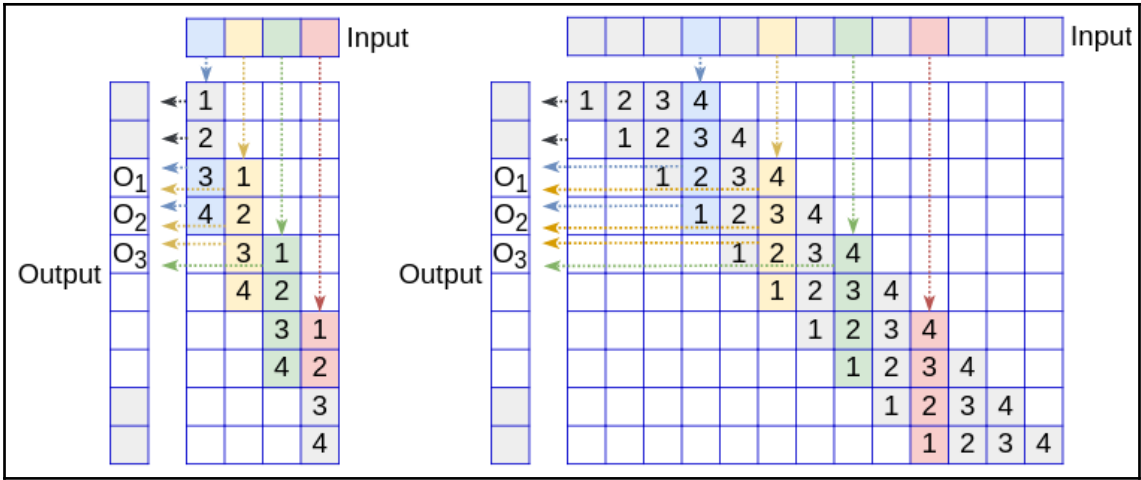

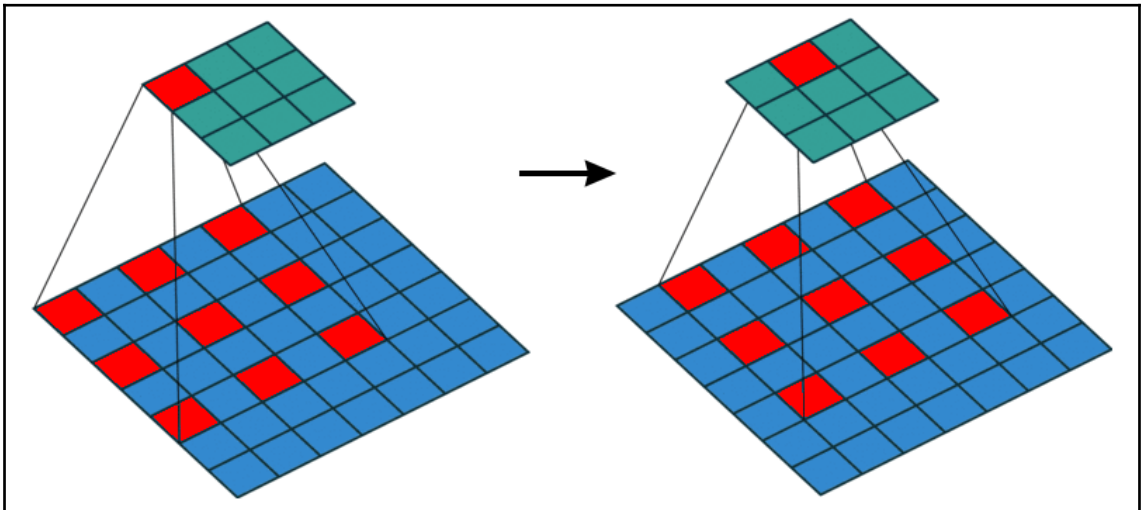
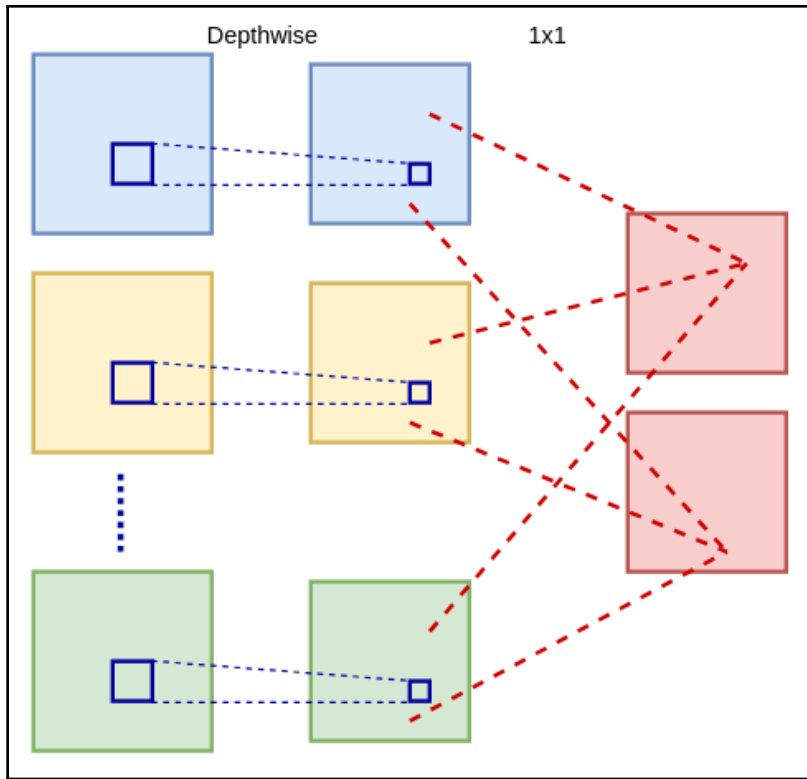

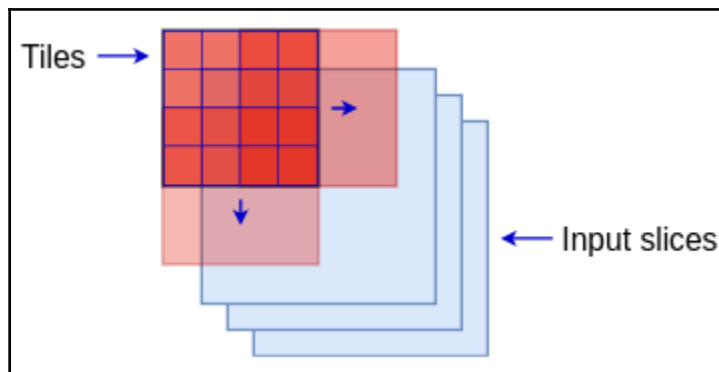
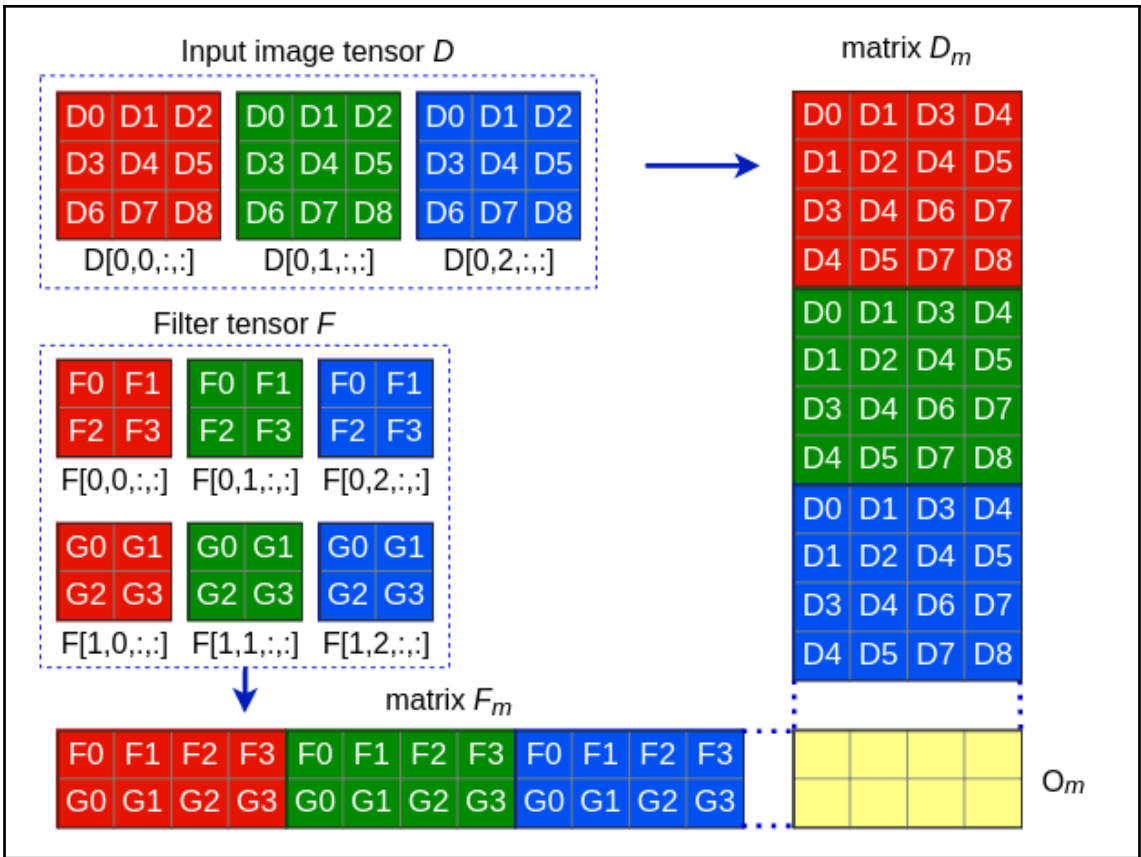

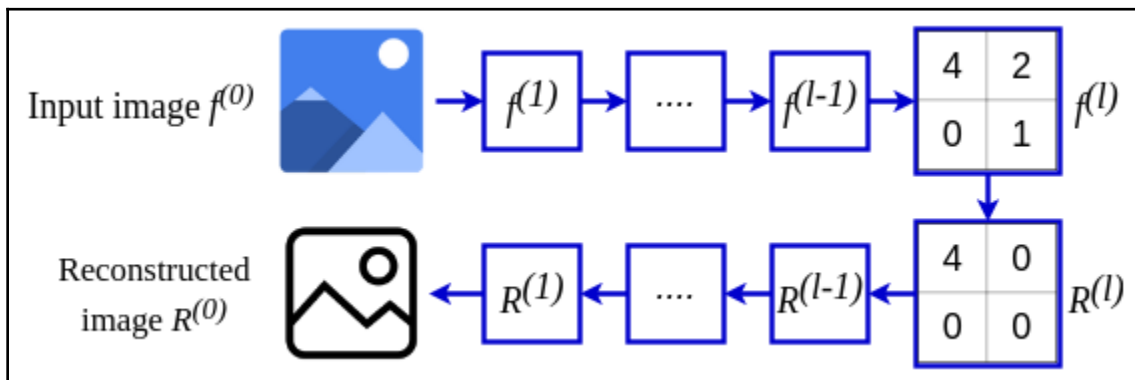
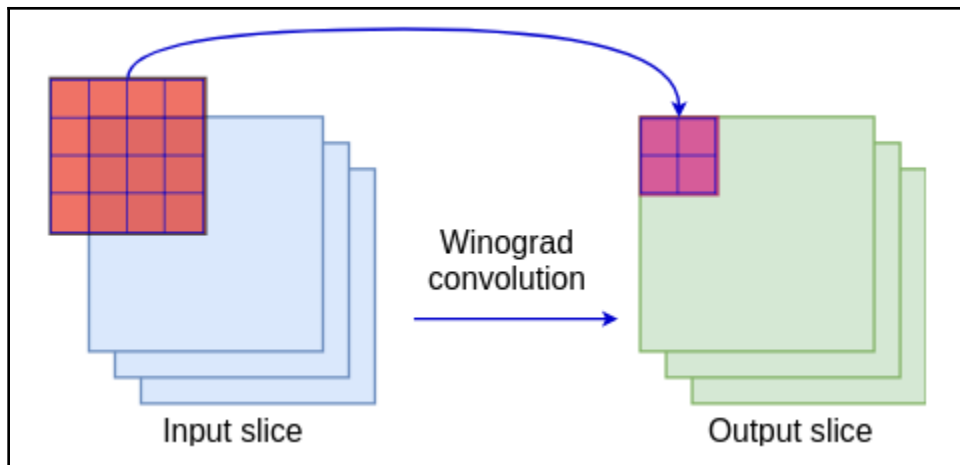

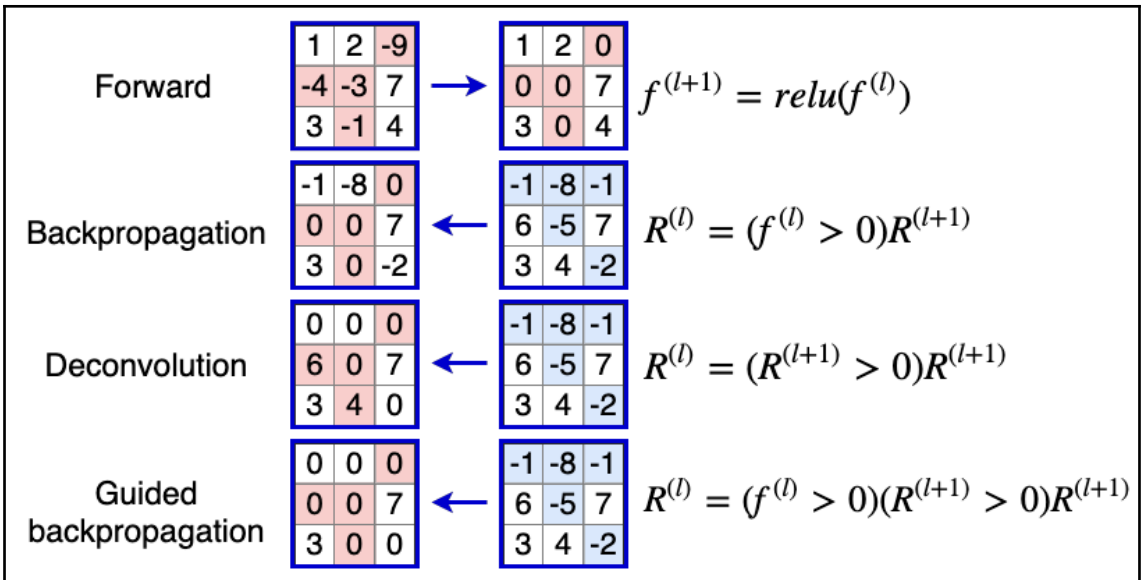

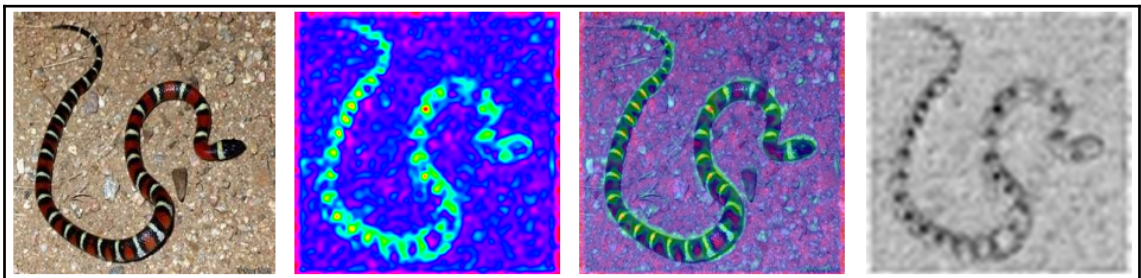
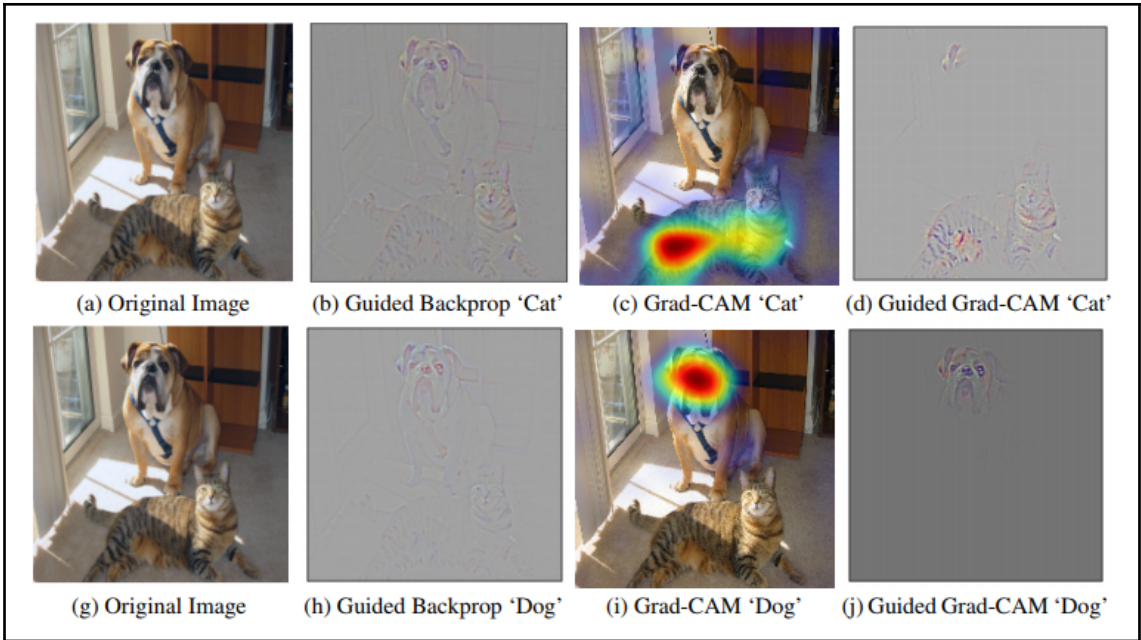

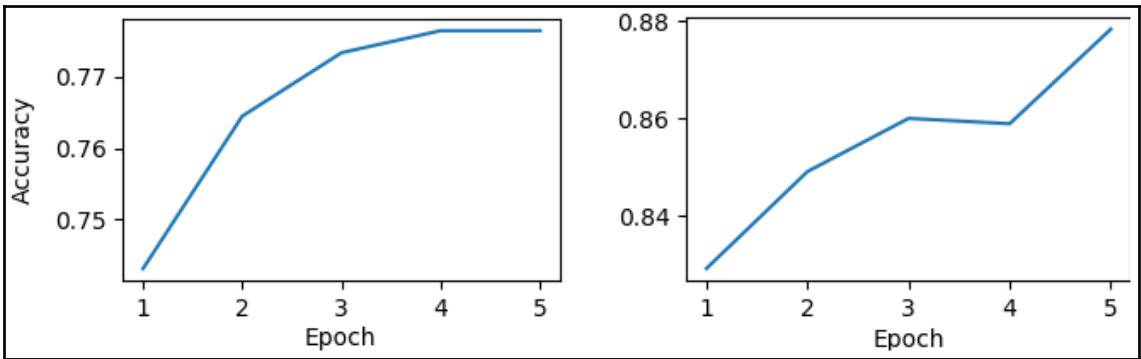
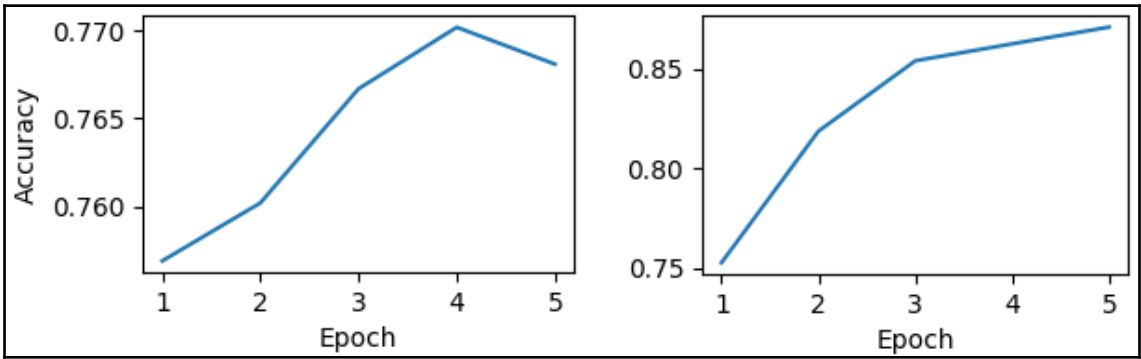
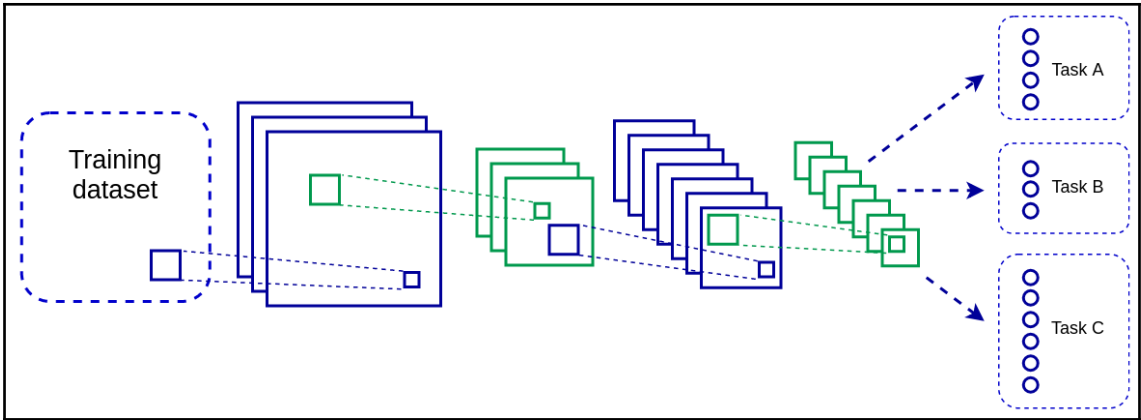

Chapter 3: Advanced Convolutional Networks

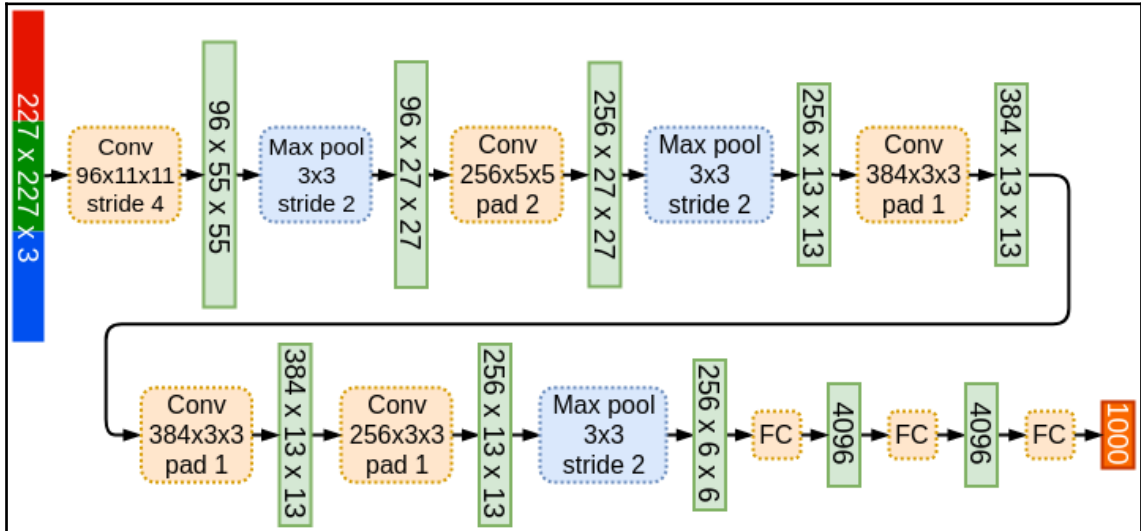

VGG16	VGG19
conv 3x3, 64	conv 3x3, 64
conv 3x3, 64	conv 3x3, 64
max pool	
conv 3x3, 128	conv 3x3, 128
conv 3x3, 128	conv 3x3, 128
max pool	
conv 3x3, 256	conv 3x3, 256
conv 3x3, 256	conv 3x3, 256
conv 3x3, 256	conv 3x3, 256
	conv 3x3, 256
max pool	
conv 3x3, 512	conv 3x3, 512
conv 3x3, 512	conv 3x3, 512
conv 3x3, 512	conv 3x3, 512
	conv 3x3, 512
max pool	
conv 3x3, 512	conv 3x3, 512
conv 3x3, 512	conv 3x3, 512
conv 3x3, 512	conv 3x3, 512
	conv 3x3, 512
max pool	
fc-4096	
fc-4096	
fc-1000	
softmax	

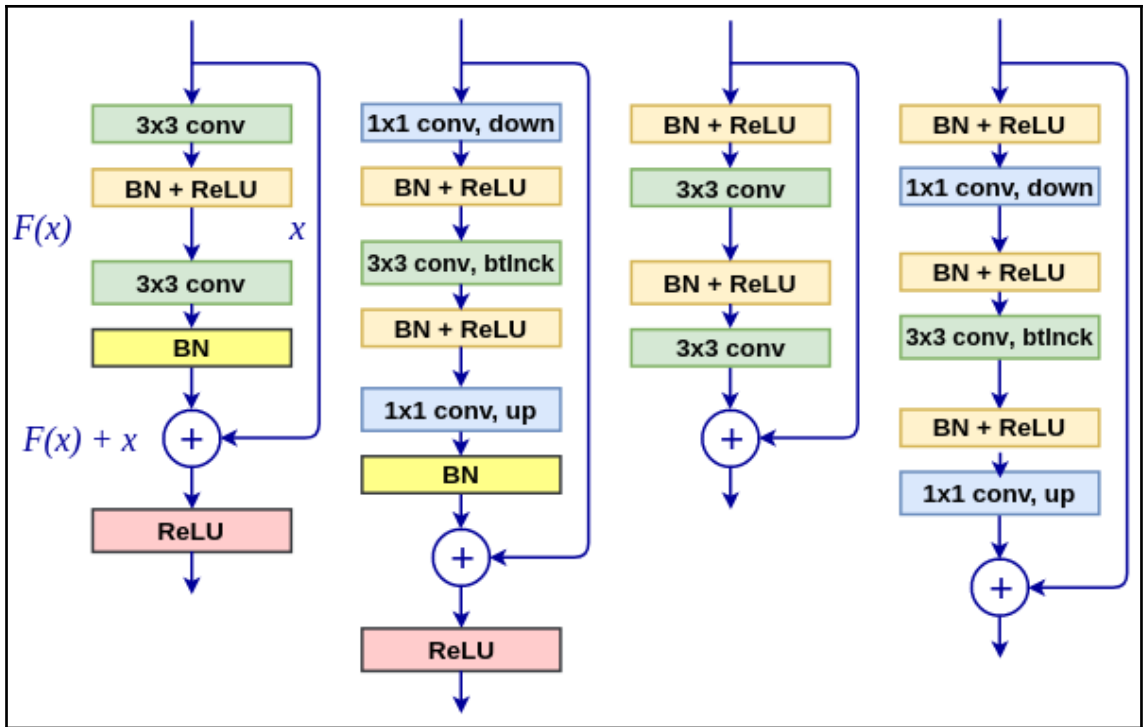

output size	18-layer	34-layer	50-layer	101-layer	152-layer
112x112	7x7 conv, stride 2				
56x56	3x3 max pool, stride 2				
	<div style="border: 1px solid black; padding: 2px; display: inline-block;"> 3x3, 64 3x3, 64 </div> x2	<div style="border: 1px solid black; padding: 2px; display: inline-block;"> 3x3, 64 3x3, 64 </div> x3	<div style="border: 1px solid black; padding: 2px; display: inline-block;"> 1x1, 64 3x3, 64 1x1, 256 </div> x3	<div style="border: 1px solid black; padding: 2px; display: inline-block;"> 1x1, 64 3x3, 64 1x1, 256 </div> x3	<div style="border: 1px solid black; padding: 2px; display: inline-block;"> 1x1, 64 3x3, 64 1x1, 256 </div> x3
28x28	<div style="border: 1px solid black; padding: 2px; display: inline-block;"> 3x3, 128 3x3, 128 </div> x2	<div style="border: 1px solid black; padding: 2px; display: inline-block;"> 3x3, 128 3x3, 128 </div> x4	<div style="border: 1px solid black; padding: 2px; display: inline-block;"> 1x1, 128 3x3, 128 1x1, 512 </div> x4	<div style="border: 1px solid black; padding: 2px; display: inline-block;"> 1x1, 128 3x3, 128 1x1, 512 </div> x4	<div style="border: 1px solid black; padding: 2px; display: inline-block;"> 1x1, 128 3x3, 128 1x1, 512 </div> x8
14x14	<div style="border: 1px solid black; padding: 2px; display: inline-block;"> 3x3, 256 3x3, 256 </div> x2	<div style="border: 1px solid black; padding: 2px; display: inline-block;"> 3x3, 256 3x3, 256 </div> x6	<div style="border: 1px solid black; padding: 2px; display: inline-block;"> 1x1, 256 3x3, 256 1x1, 1024 </div> x6	<div style="border: 1px solid black; padding: 2px; display: inline-block;"> 1x1, 256 3x3, 256 1x1, 1024 </div> x23	<div style="border: 1px solid black; padding: 2px; display: inline-block;"> 1x1, 256 3x3, 256 1x1, 1024 </div> x36
7x7	<div style="border: 1px solid black; padding: 2px; display: inline-block;"> 3x3, 512 3x3, 512 </div> x2	<div style="border: 1px solid black; padding: 2px; display: inline-block;"> 3x3, 512 3x3, 512 </div> x3	<div style="border: 1px solid black; padding: 2px; display: inline-block;"> 1x1, 512 3x3, 512 1x1, 2048 </div> x3	<div style="border: 1px solid black; padding: 2px; display: inline-block;"> 1x1, 512 3x3, 512 1x1, 2048 </div> x3	<div style="border: 1px solid black; padding: 2px; display: inline-block;"> 1x1, 512 3x3, 512 1x1, 2048 </div> x3
1x1	average pool, 1000-d fc, softmax				

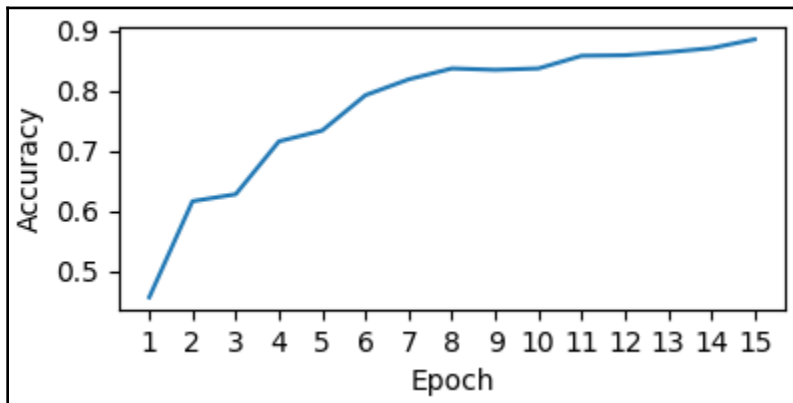

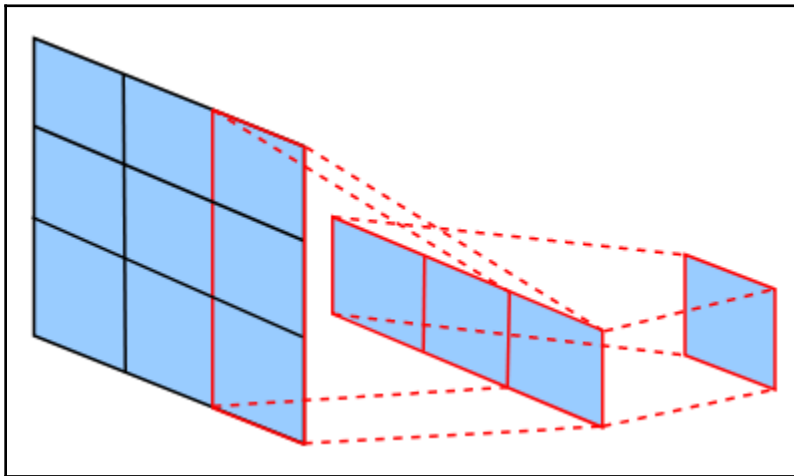
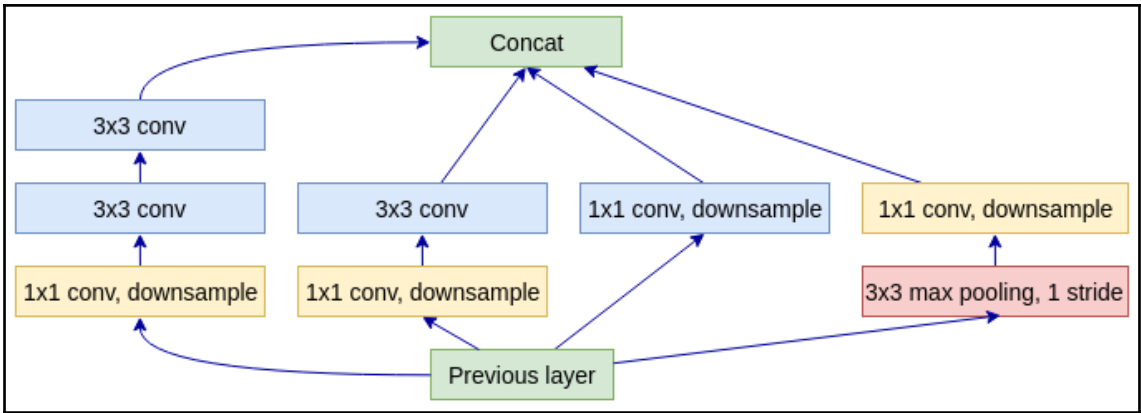
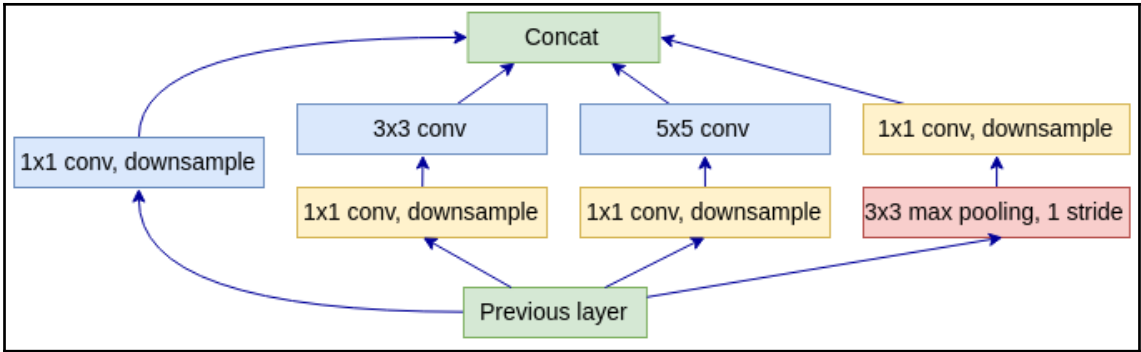

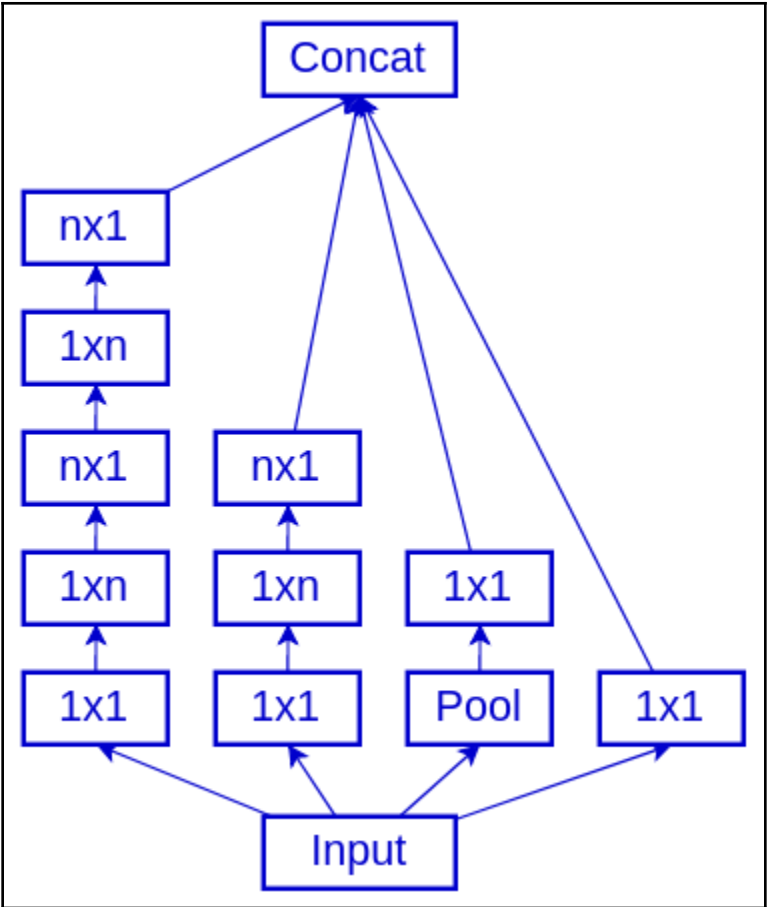

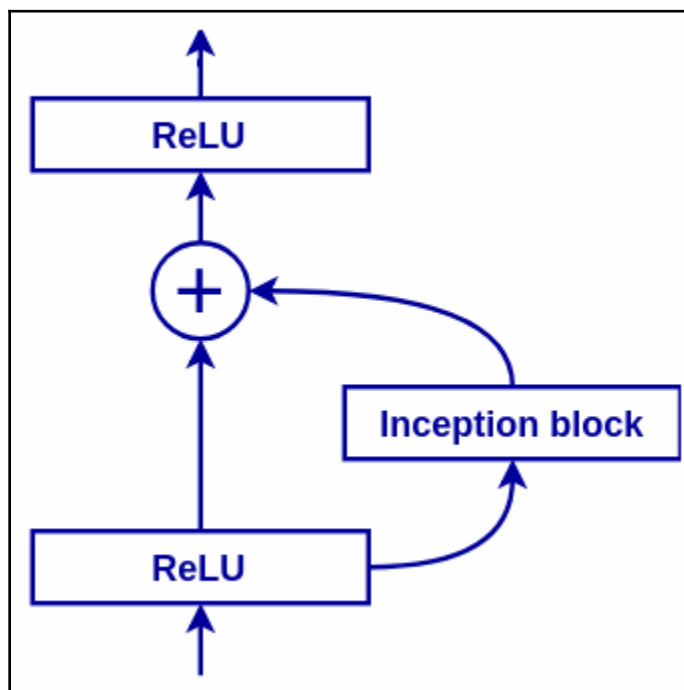
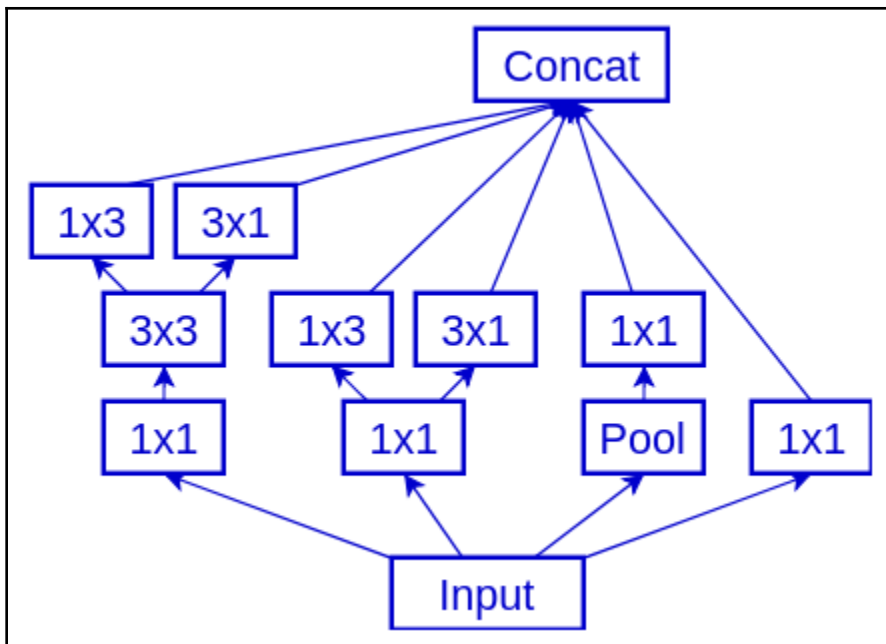

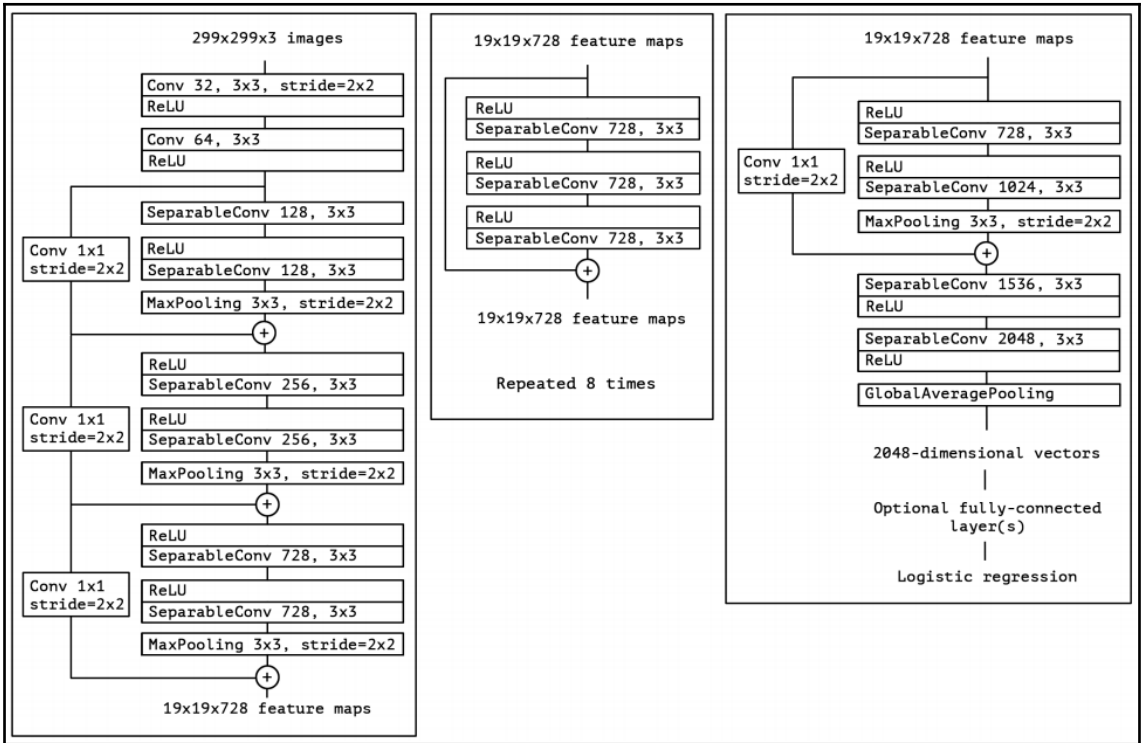
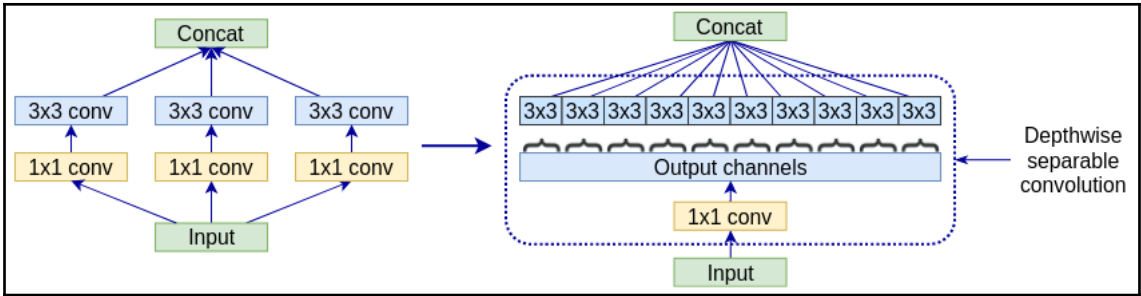

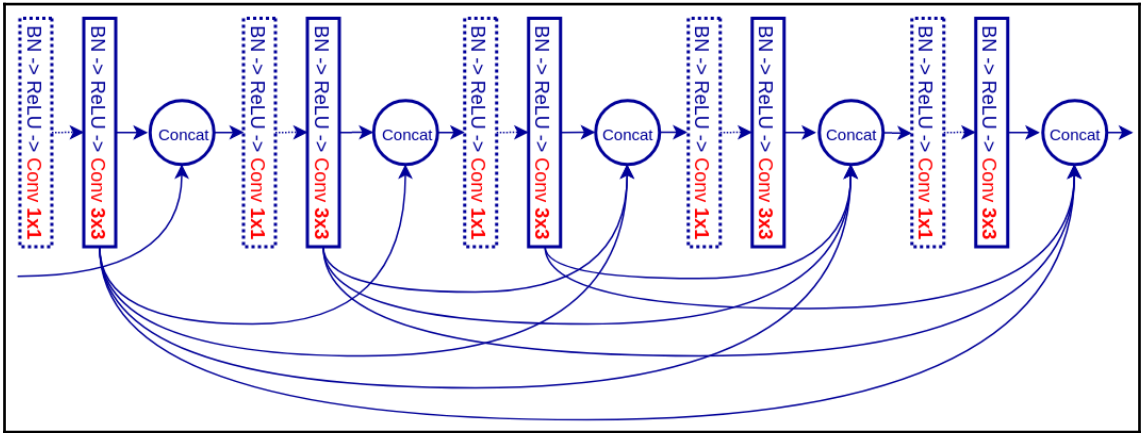
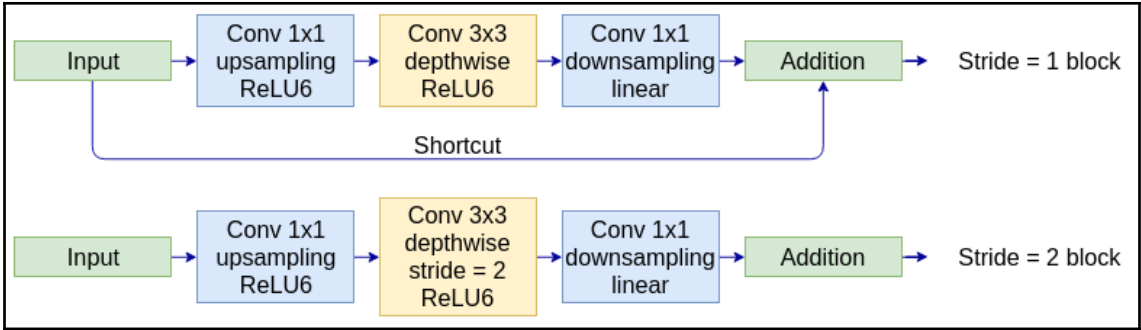

Layers	Output Size	DenseNet-121	DenseNet-169	DenseNet-201	DenseNet-264
Convolution	112 × 112	7 × 7 conv, stride 2			
Pooling	56 × 56	3 × 3 max pool, stride 2			
Dense Block (1)	56 × 56	$\begin{bmatrix} 1 \times 1 \text{ conv} \\ 3 \times 3 \text{ conv} \end{bmatrix} \times 6$	$\begin{bmatrix} 1 \times 1 \text{ conv} \\ 3 \times 3 \text{ conv} \end{bmatrix} \times 6$	$\begin{bmatrix} 1 \times 1 \text{ conv} \\ 3 \times 3 \text{ conv} \end{bmatrix} \times 6$	$\begin{bmatrix} 1 \times 1 \text{ conv} \\ 3 \times 3 \text{ conv} \end{bmatrix} \times 6$
Transition Layer (1)	56 × 56	1 × 1 conv			
	28 × 28	2 × 2 average pool, stride 2			
Dense Block (2)	28 × 28	$\begin{bmatrix} 1 \times 1 \text{ conv} \\ 3 \times 3 \text{ conv} \end{bmatrix} \times 12$	$\begin{bmatrix} 1 \times 1 \text{ conv} \\ 3 \times 3 \text{ conv} \end{bmatrix} \times 12$	$\begin{bmatrix} 1 \times 1 \text{ conv} \\ 3 \times 3 \text{ conv} \end{bmatrix} \times 12$	$\begin{bmatrix} 1 \times 1 \text{ conv} \\ 3 \times 3 \text{ conv} \end{bmatrix} \times 12$
Transition Layer (2)	28 × 28	1 × 1 conv			
	14 × 14	2 × 2 average pool, stride 2			
Dense Block (3)	14 × 14	$\begin{bmatrix} 1 \times 1 \text{ conv} \\ 3 \times 3 \text{ conv} \end{bmatrix} \times 24$	$\begin{bmatrix} 1 \times 1 \text{ conv} \\ 3 \times 3 \text{ conv} \end{bmatrix} \times 32$	$\begin{bmatrix} 1 \times 1 \text{ conv} \\ 3 \times 3 \text{ conv} \end{bmatrix} \times 48$	$\begin{bmatrix} 1 \times 1 \text{ conv} \\ 3 \times 3 \text{ conv} \end{bmatrix} \times 64$
Transition Layer (3)	14 × 14	1 × 1 conv			
	7 × 7	2 × 2 average pool, stride 2			
Dense Block (4)	7 × 7	$\begin{bmatrix} 1 \times 1 \text{ conv} \\ 3 \times 3 \text{ conv} \end{bmatrix} \times 16$	$\begin{bmatrix} 1 \times 1 \text{ conv} \\ 3 \times 3 \text{ conv} \end{bmatrix} \times 32$	$\begin{bmatrix} 1 \times 1 \text{ conv} \\ 3 \times 3 \text{ conv} \end{bmatrix} \times 32$	$\begin{bmatrix} 1 \times 1 \text{ conv} \\ 3 \times 3 \text{ conv} \end{bmatrix} \times 48$
Classification Layer	1 × 1	7 × 7 global average pool			
		1000D fully connected, softmax			

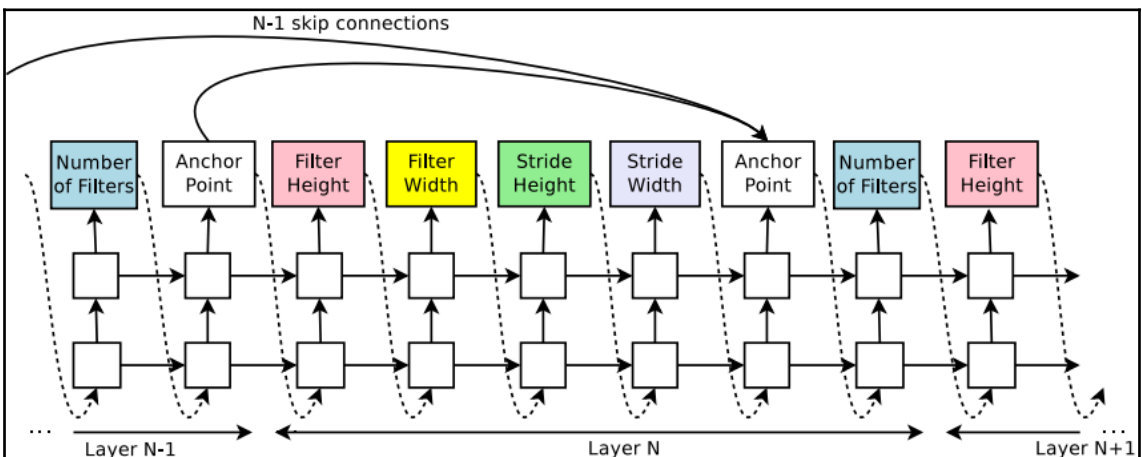
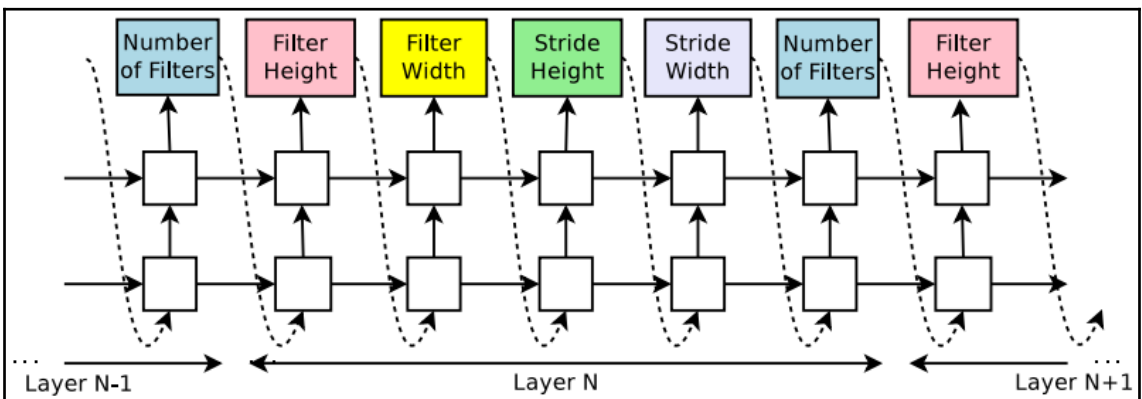
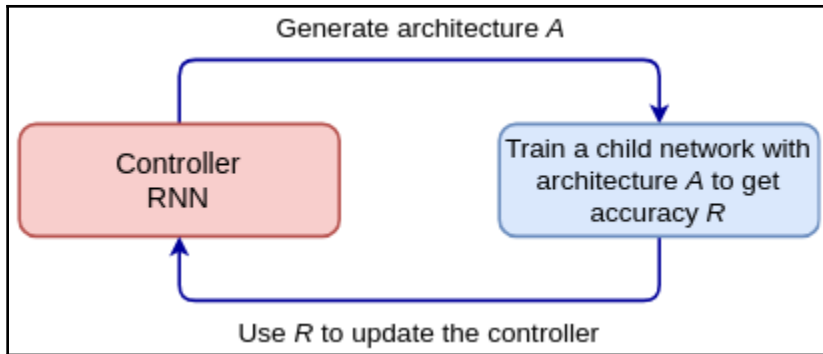

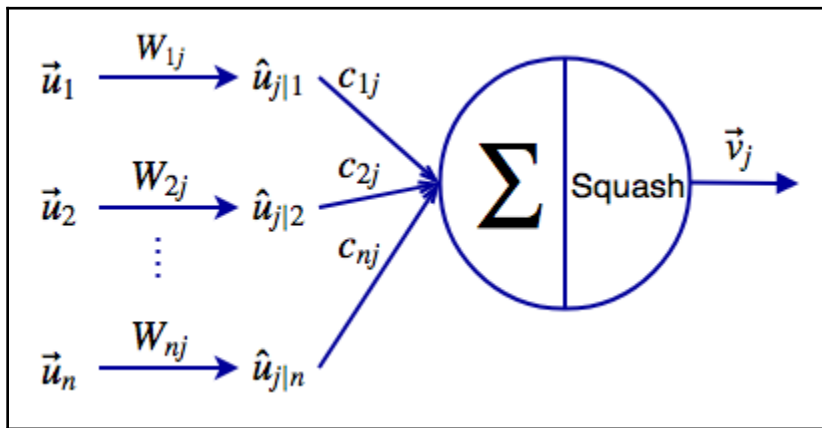
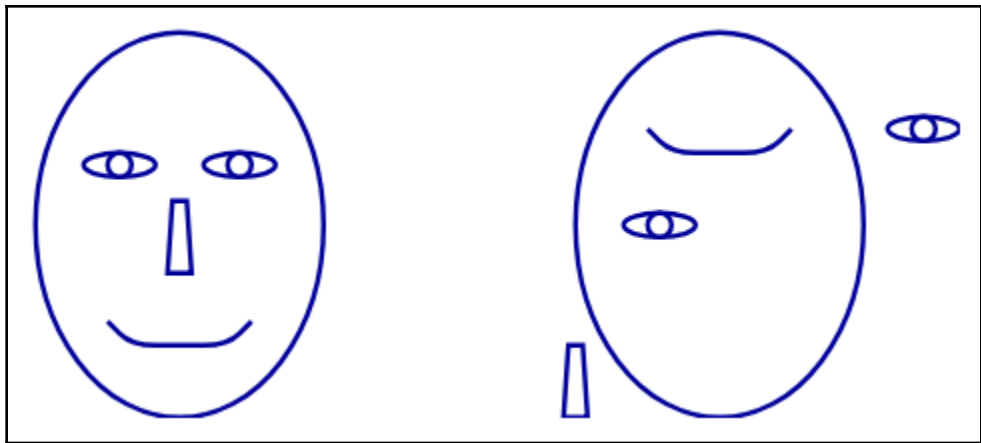

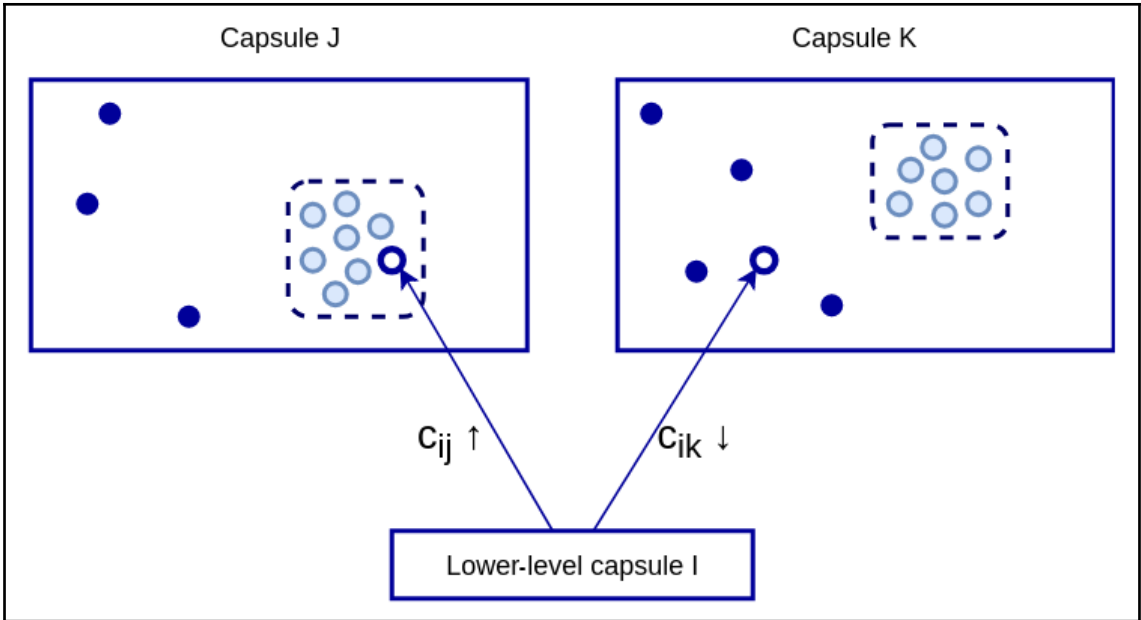

Chapter 4: Object Detection and Image Segmentation



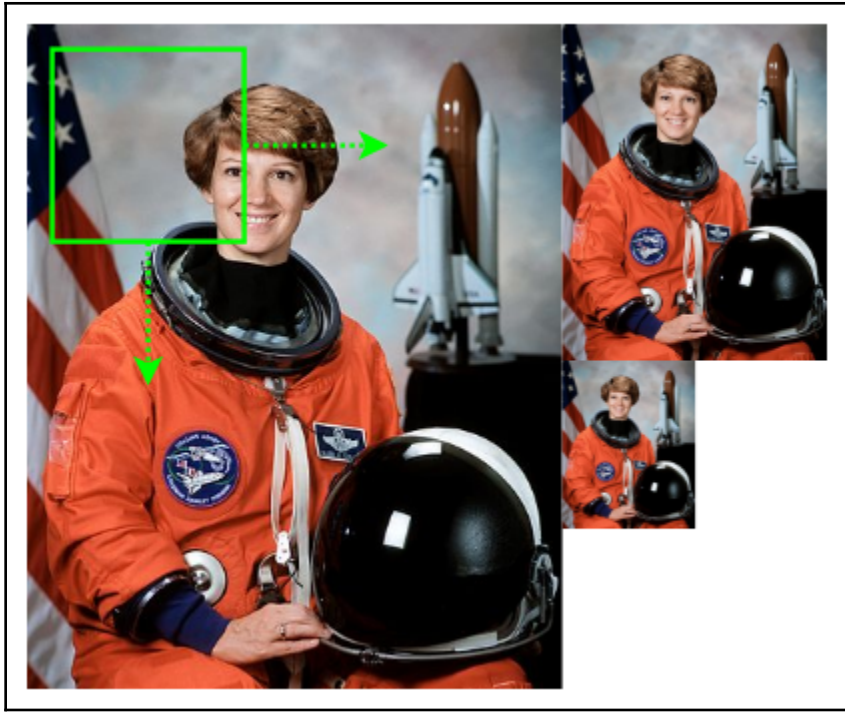

	Type	Filters	Size	Output
	Convolutional	32	3 × 3	256 × 256
	Convolutional	64	3 × 3 / 2	128 × 128
1x	Convolutional	32	1 × 1	
	Convolutional	64	3 × 3	
	Residual			128 × 128
	Convolutional	128	3 × 3 / 2	64 × 64
2x	Convolutional	64	1 × 1	
	Convolutional	128	3 × 3	
	Residual			64 × 64
	Convolutional	256	3 × 3 / 2	32 × 32
8x	Convolutional	128	1 × 1	
	Convolutional	256	3 × 3	
	Residual			32 × 32
	Convolutional	512	3 × 3 / 2	16 × 16
8x	Convolutional	256	1 × 1	
	Convolutional	512	3 × 3	
	Residual			16 × 16
	Convolutional	1024	3 × 3 / 2	8 × 8
4x	Convolutional	512	1 × 1	
	Convolutional	1024	3 × 3	
	Residual			8 × 8
	Avgpool		Global	
	Connected		1000	
	Softmax			

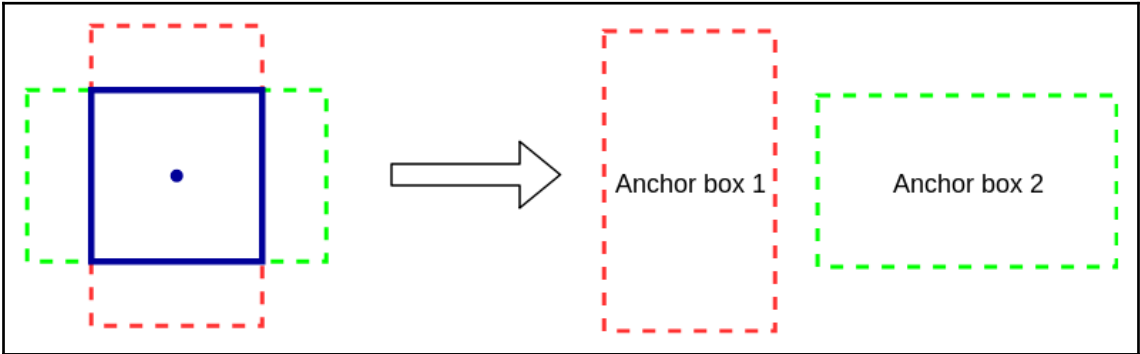
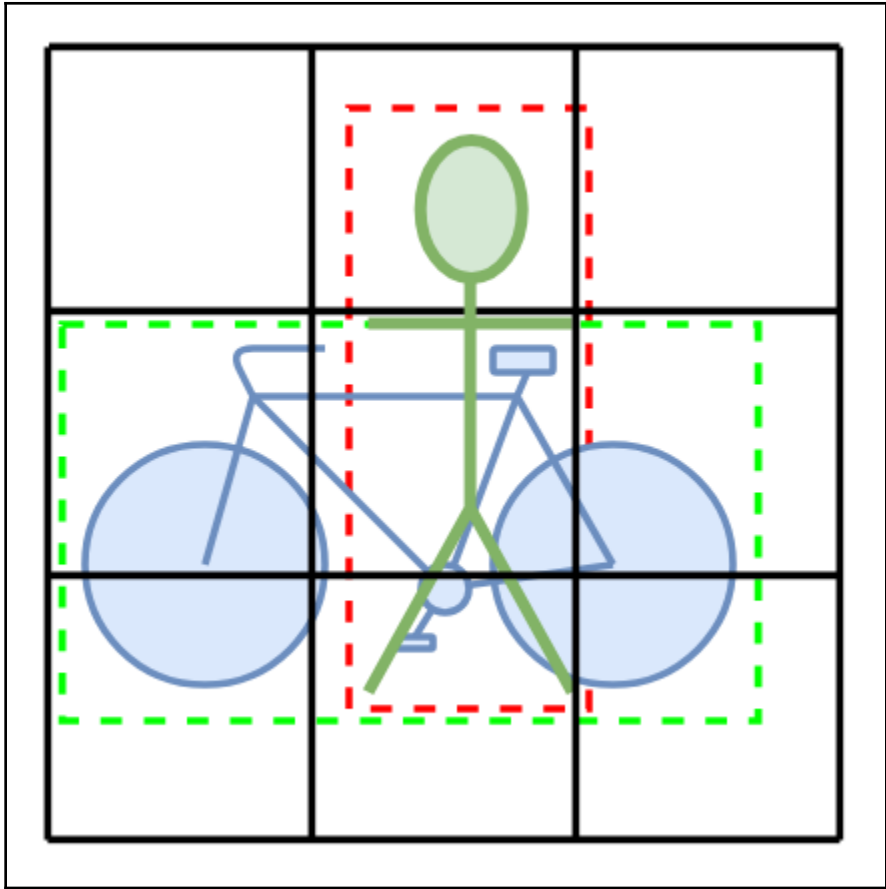

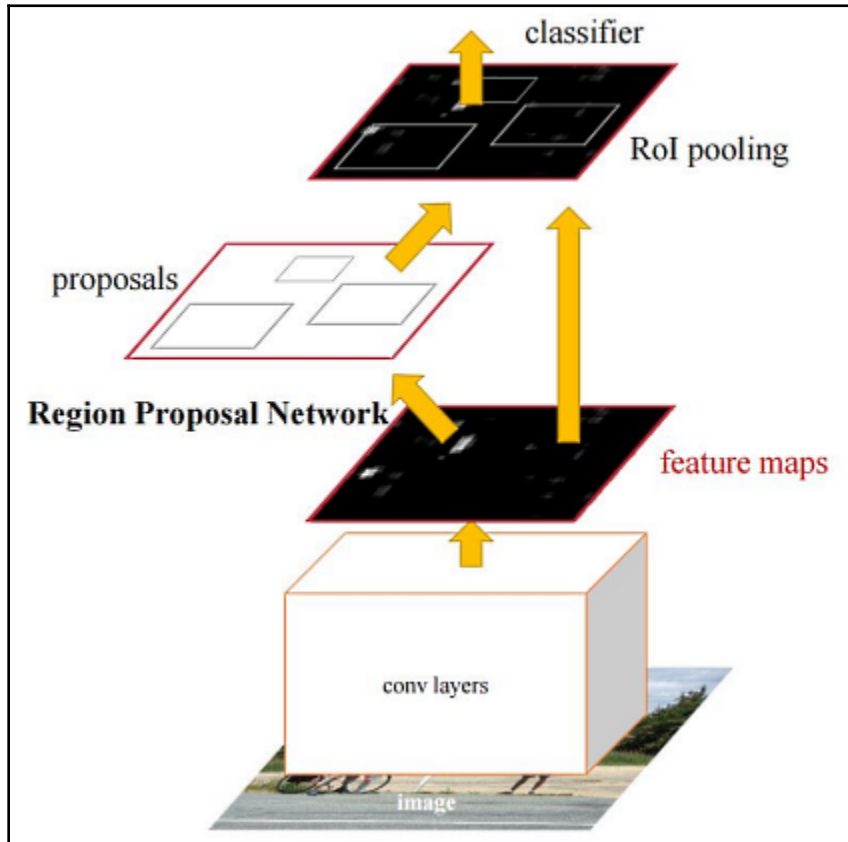
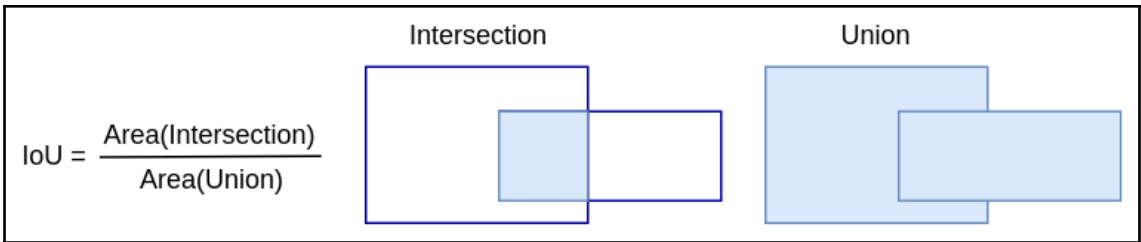

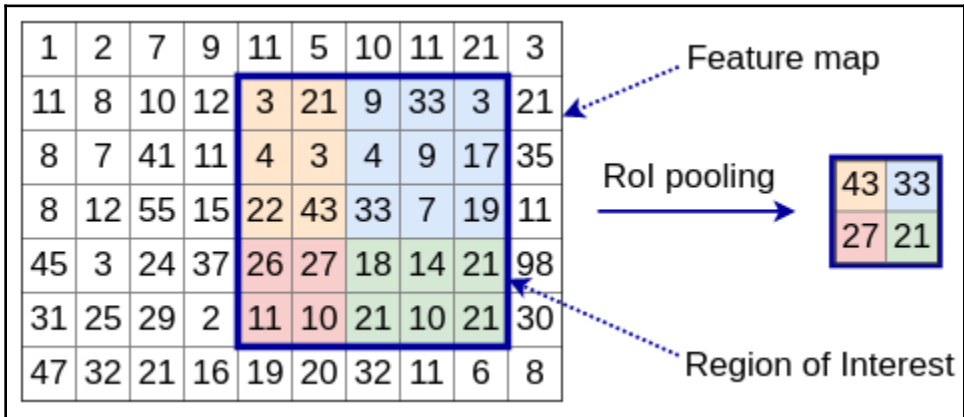
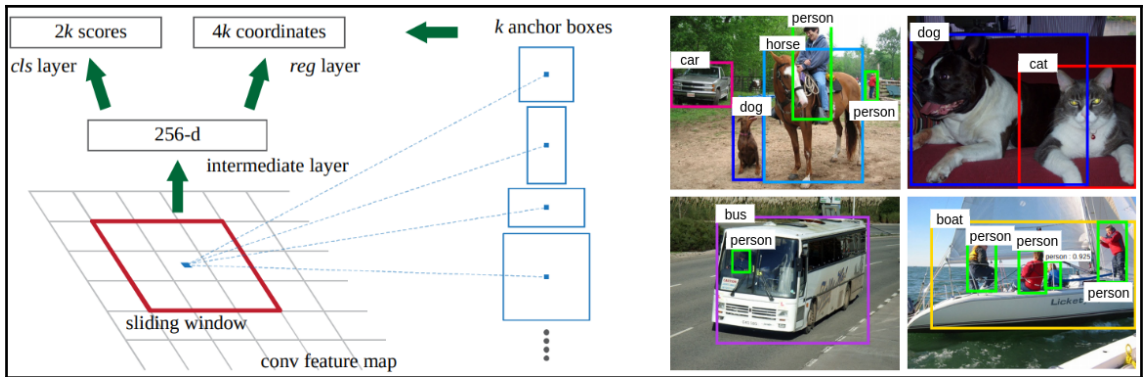



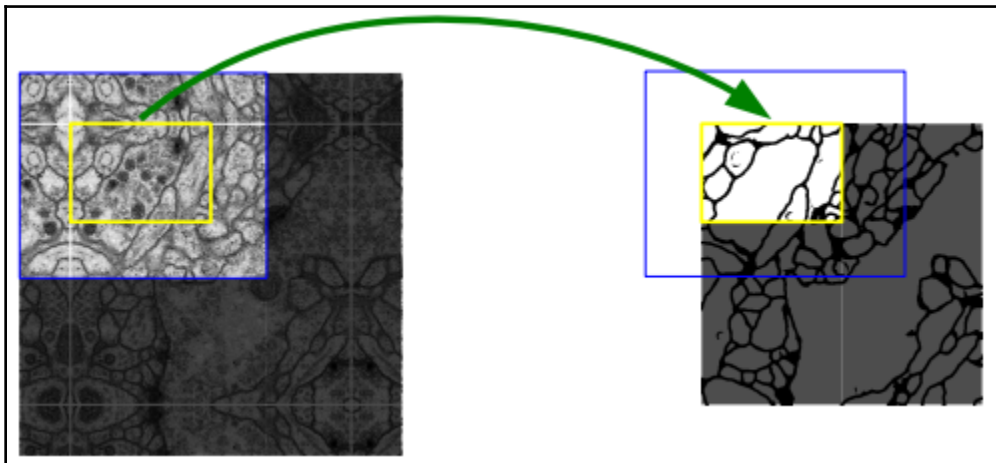
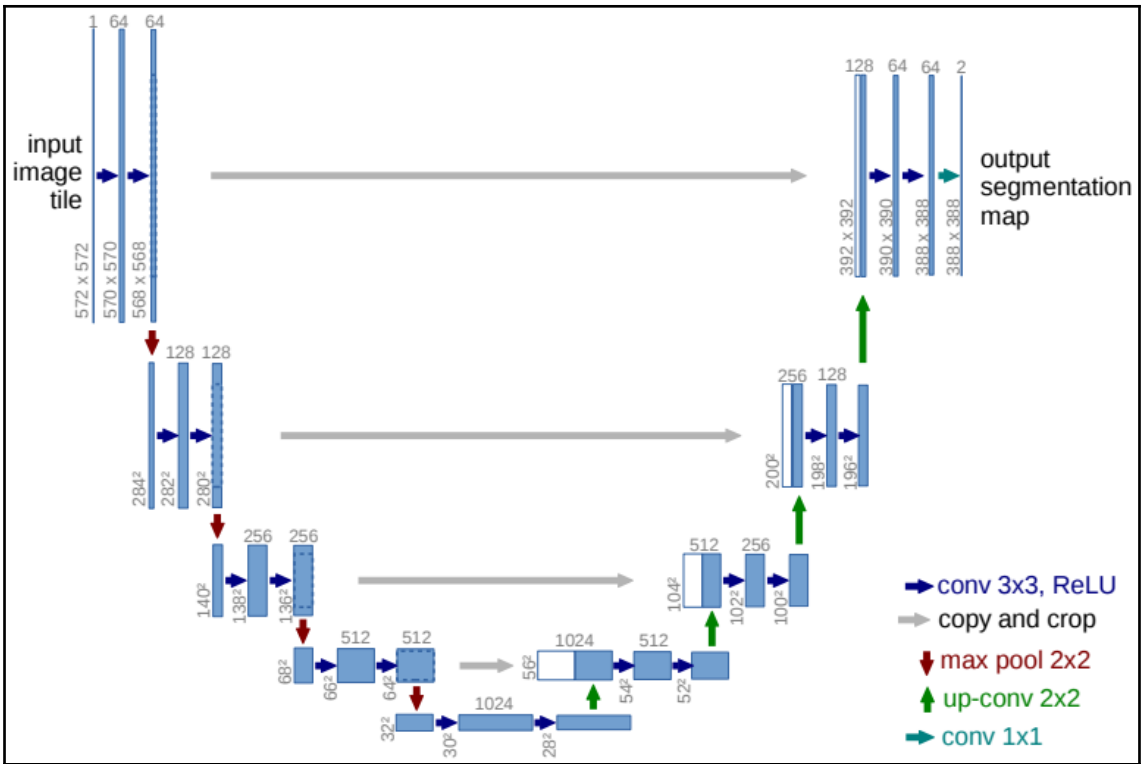

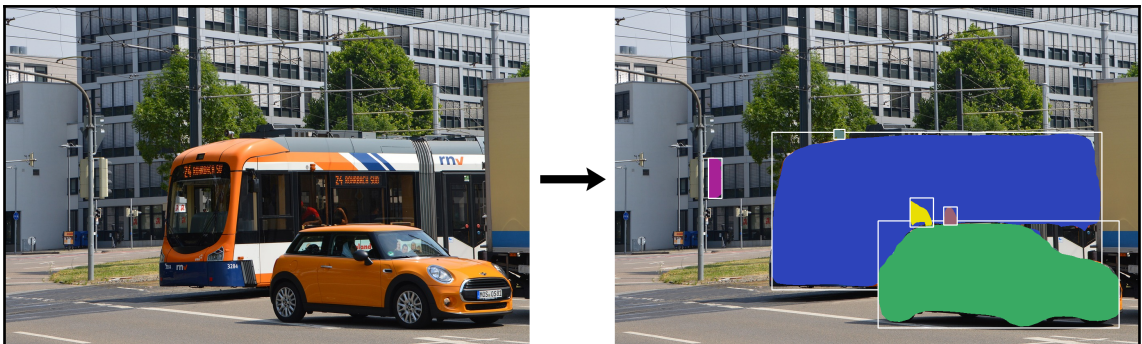
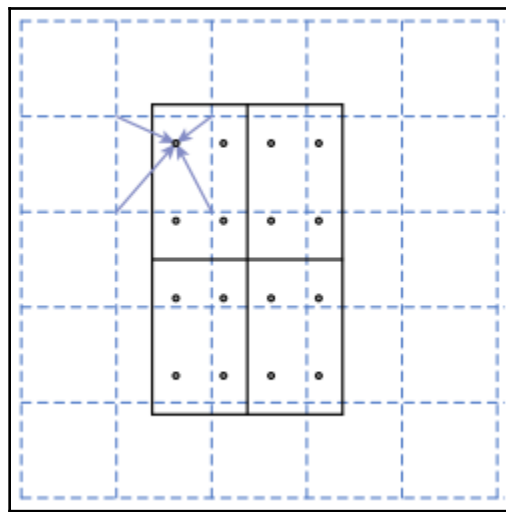
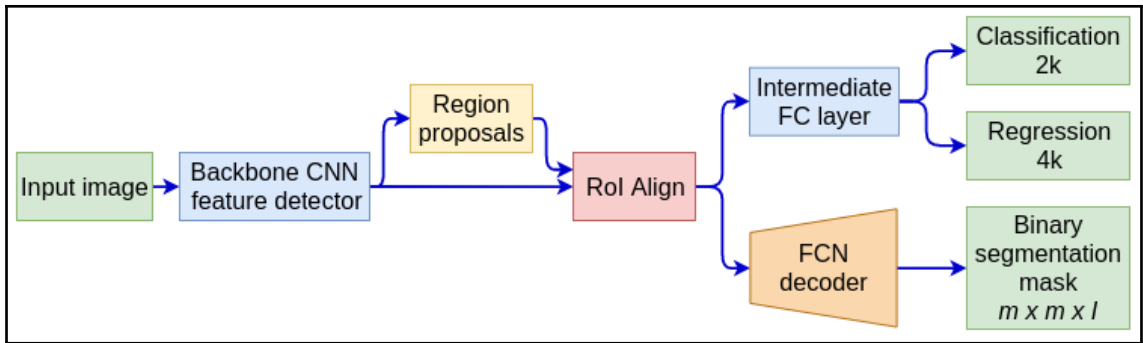

Chapter 5: Generative Models

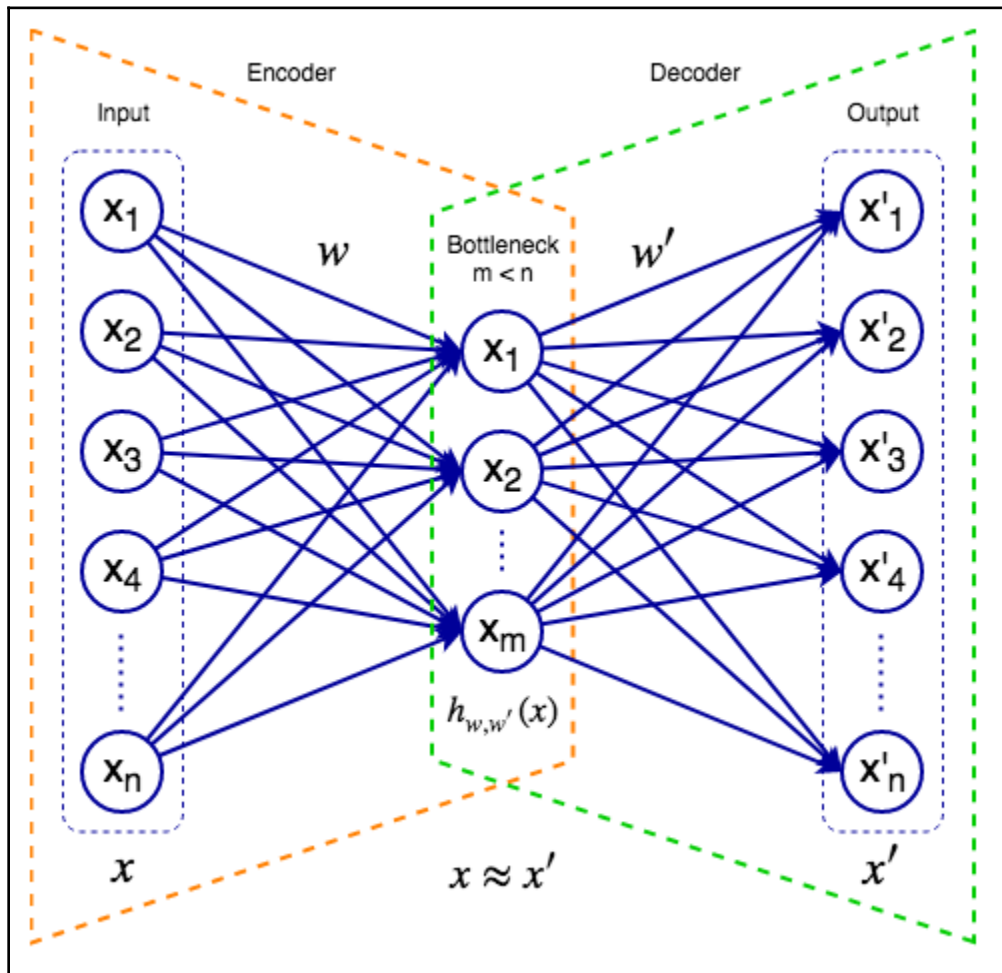

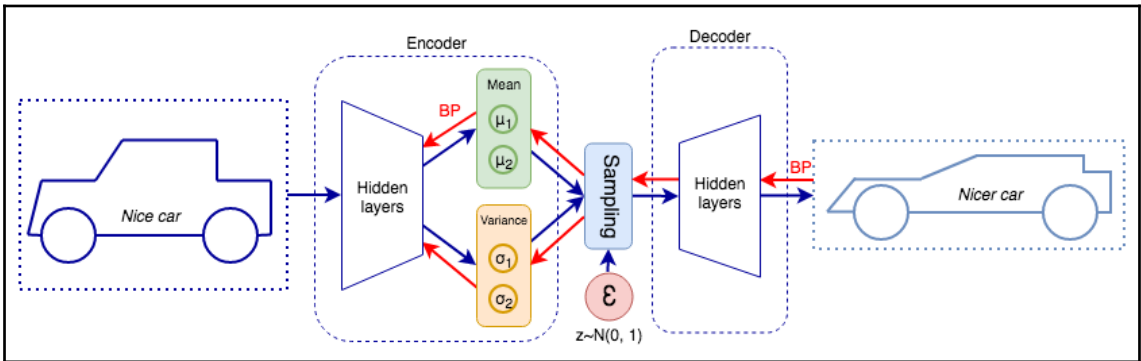
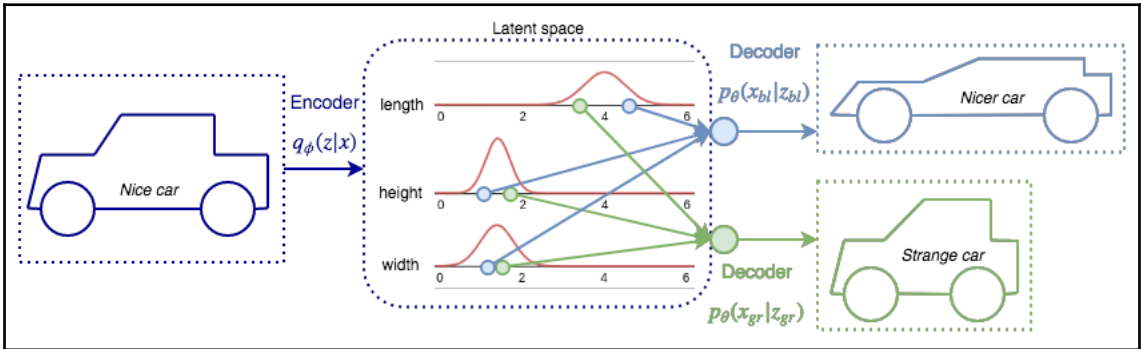
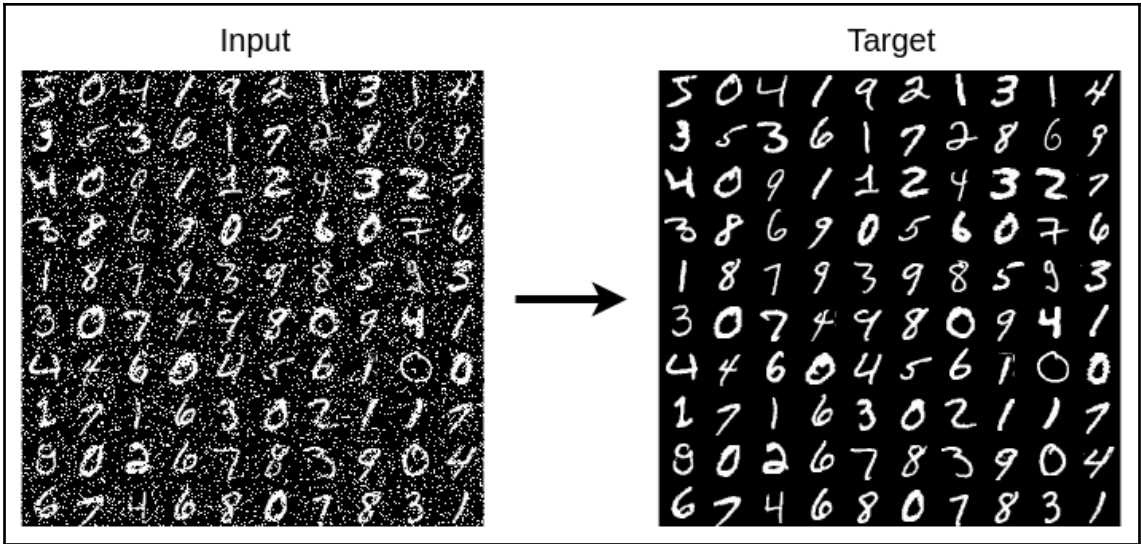

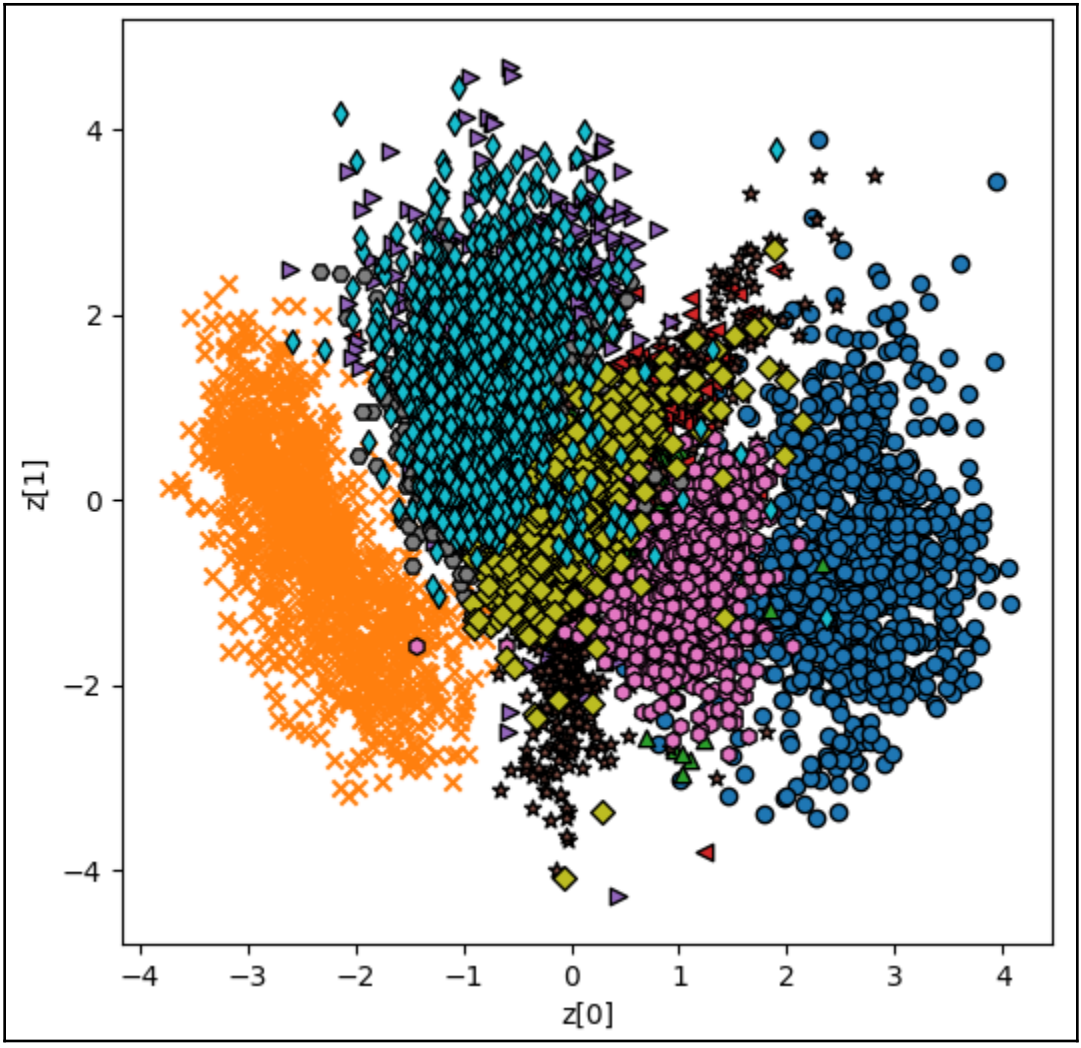

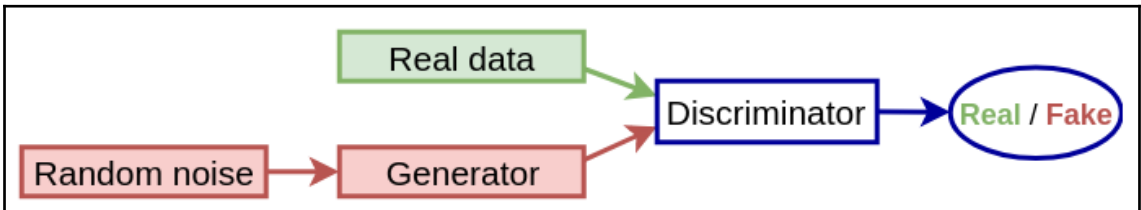
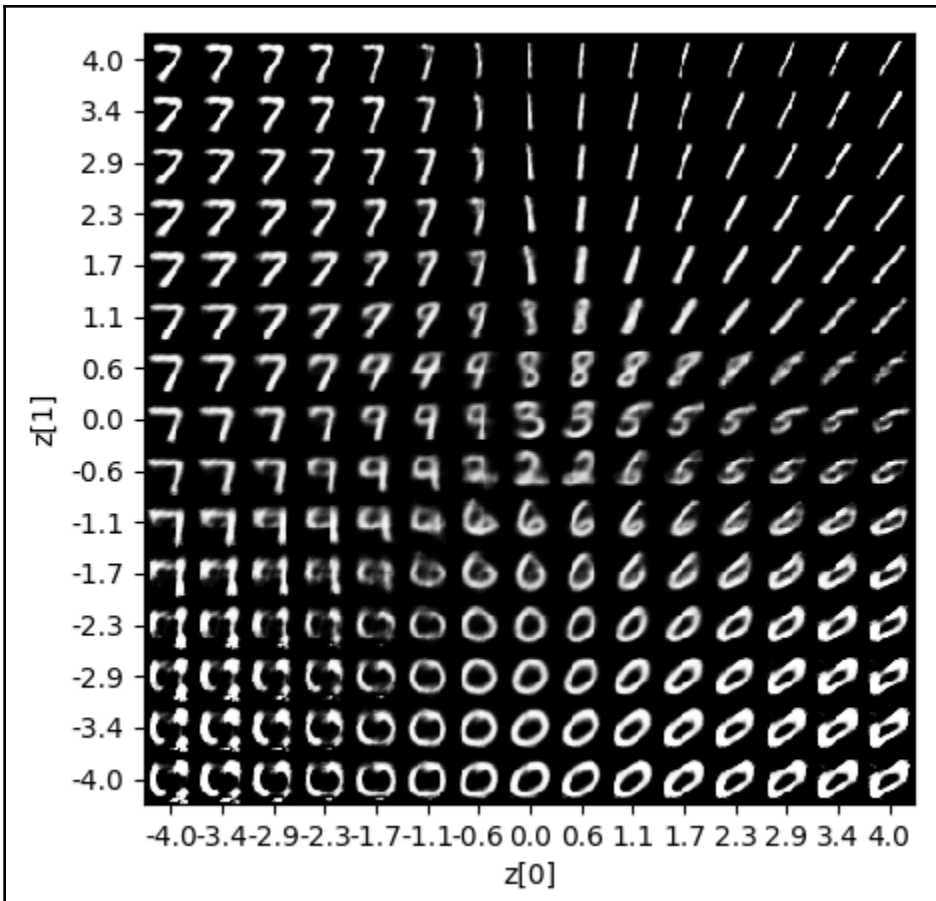

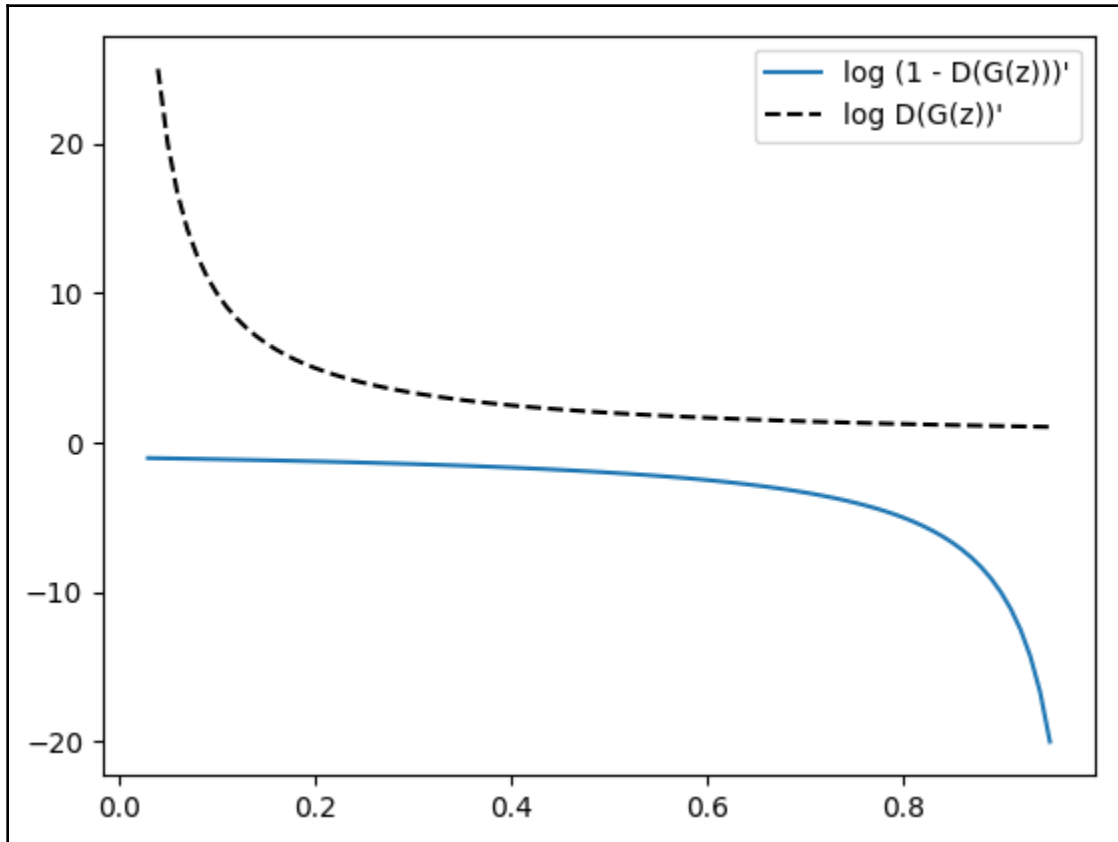
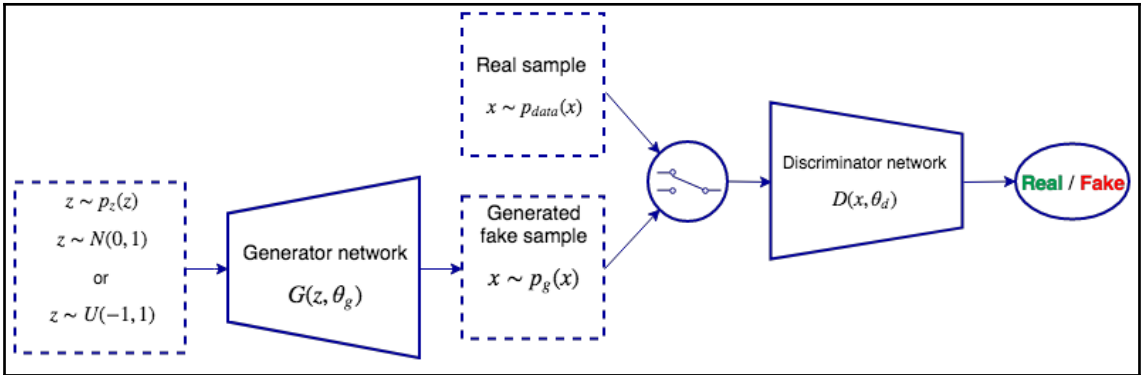

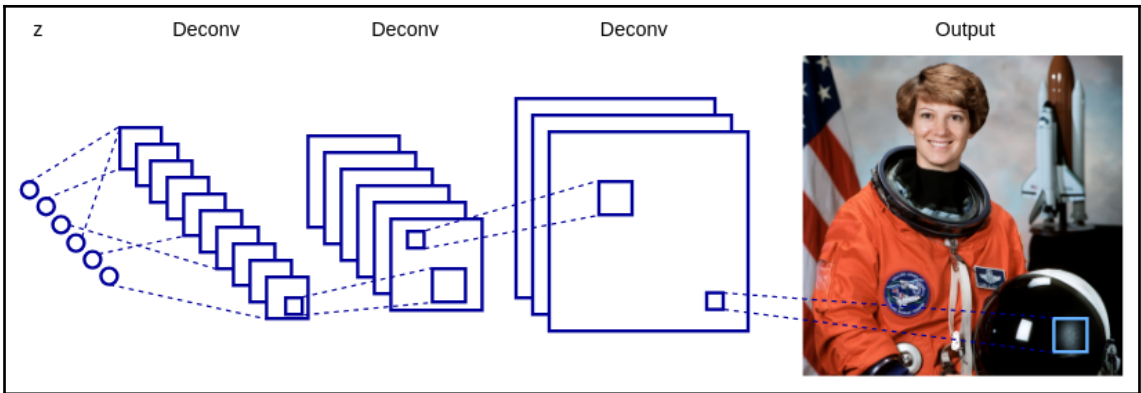

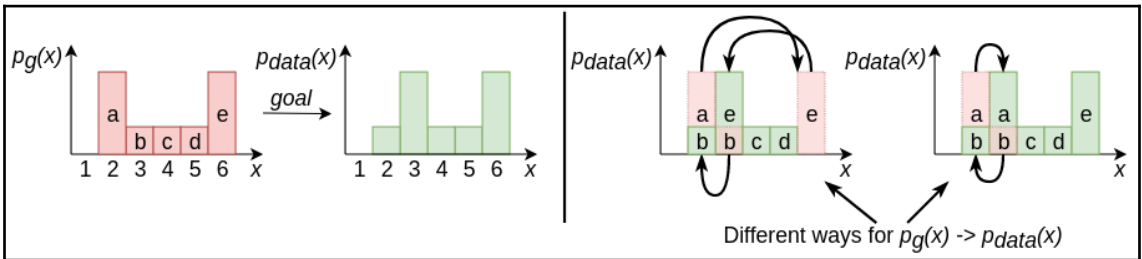
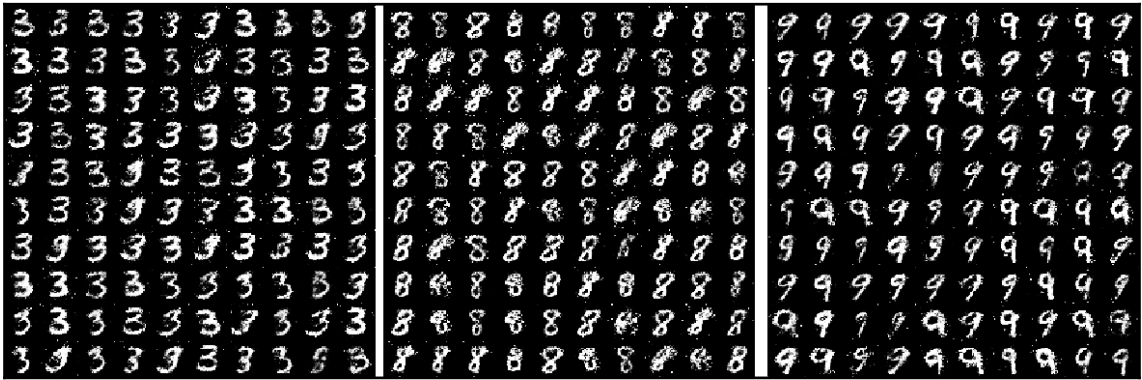
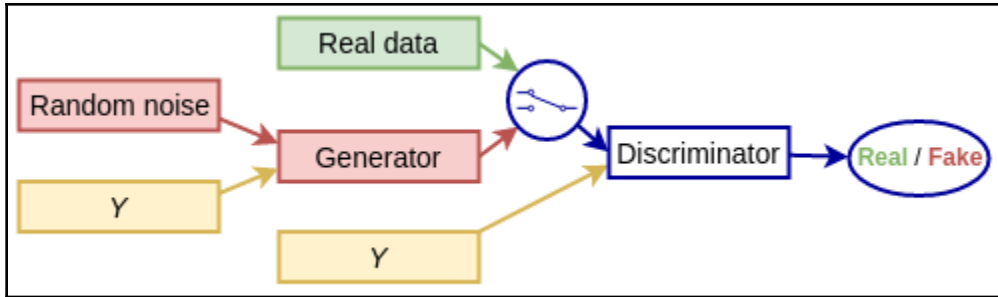

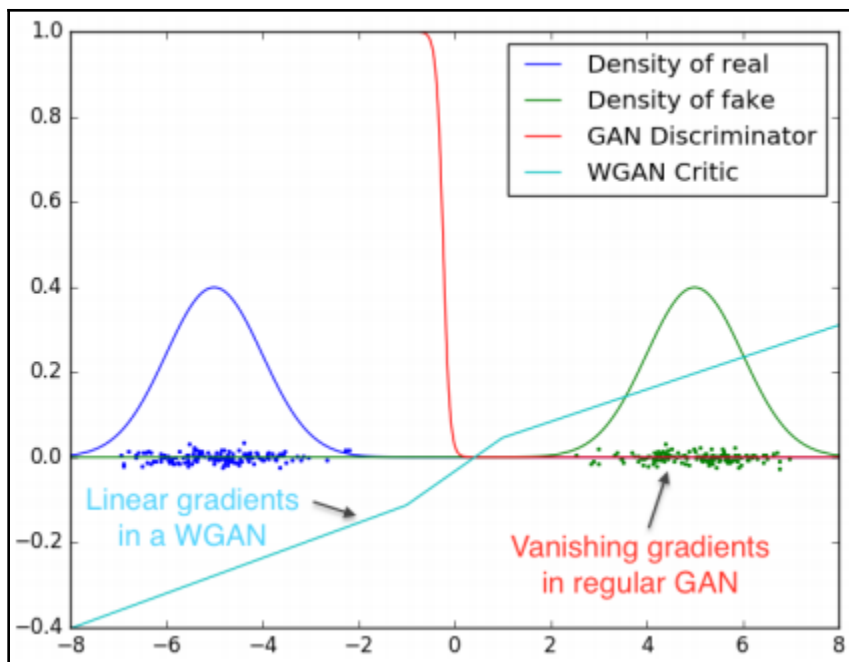

Algorithm 1 WGAN, our proposed algorithm. All experiments in the paper used the default values $\alpha = 0.00005$, $c = 0.01$, $m = 64$, $n_{\text{critic}} = 5$.

Require: : α , the learning rate. c , the clipping parameter. m , the batch size. n_{critic} , the number of iterations of the critic per generator iteration.

Require: : w_0 , initial critic parameters. θ_0 , initial generator's parameters.

```

1: while  $\theta$  has not converged do
2:   for  $t = 0, \dots, n_{\text{critic}}$  do
3:     Sample  $\{x^{(i)}\}_{i=1}^m \sim \mathbb{P}_r$  a batch from the real data.
4:     Sample  $\{z^{(i)}\}_{i=1}^m \sim p(z)$  a batch of prior samples.
5:      $g_w \leftarrow \nabla_w \left[ \frac{1}{m} \sum_{i=1}^m f_w(x^{(i)}) - \frac{1}{m} \sum_{i=1}^m f_w(g_\theta(z^{(i)})) \right]$ 
6:      $w \leftarrow w + \alpha \cdot \text{RMSProp}(w, g_w)$ 
7:      $w \leftarrow \text{clip}(w, -c, c)$ 
8:   end for
9:   Sample  $\{z^{(i)}\}_{i=1}^m \sim p(z)$  a batch of prior samples.
10:   $g_\theta \leftarrow -\nabla_\theta \frac{1}{m} \sum_{i=1}^m f_w(g_\theta(z^{(i)}))$ 
11:   $\theta \leftarrow \theta - \alpha \cdot \text{RMSProp}(\theta, g_\theta)$ 
12: end while

```

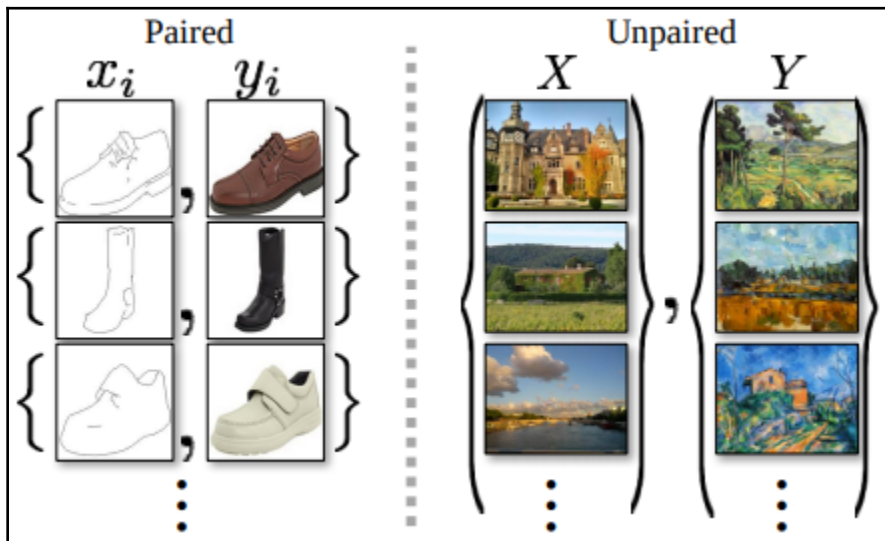

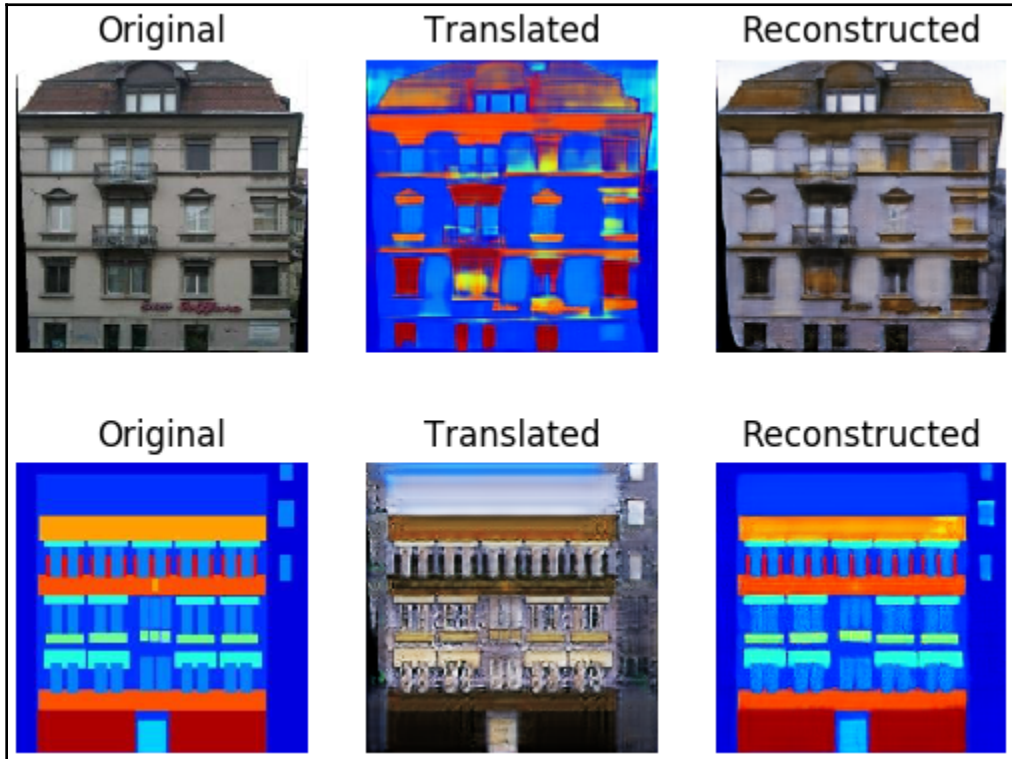
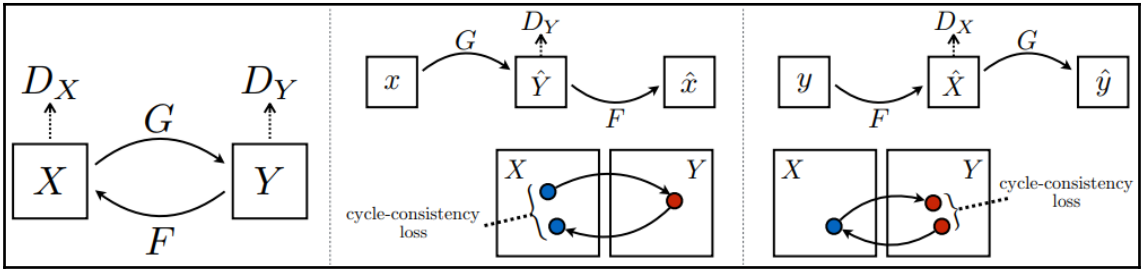



Chapter 6: Language Modeling

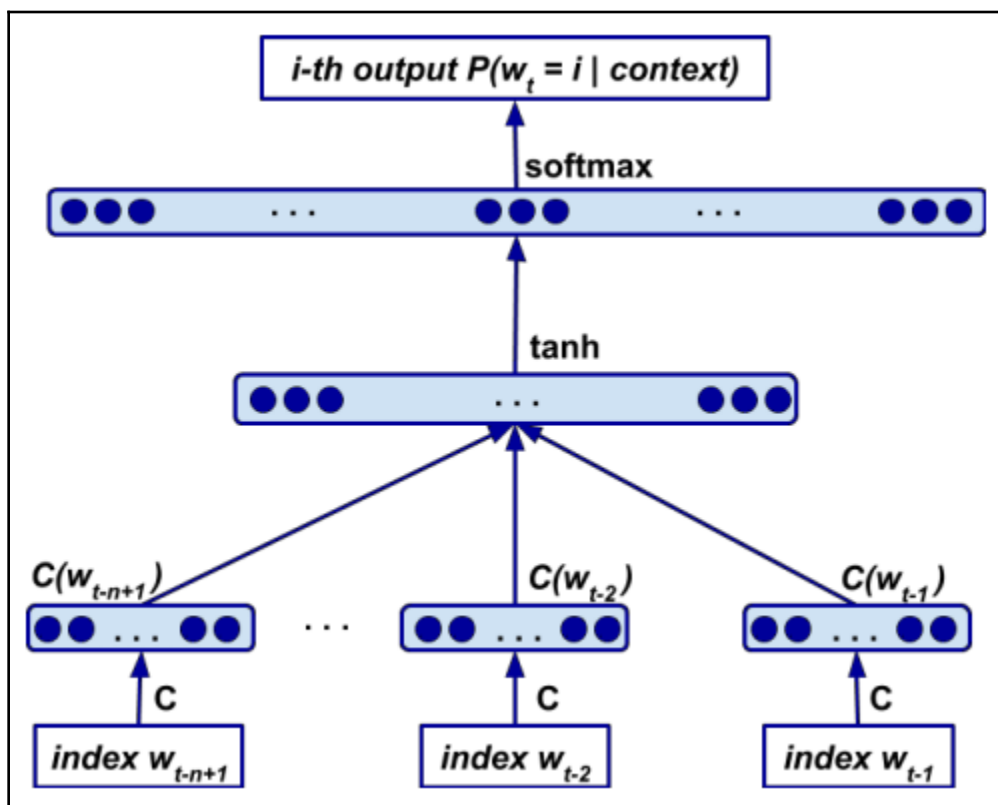
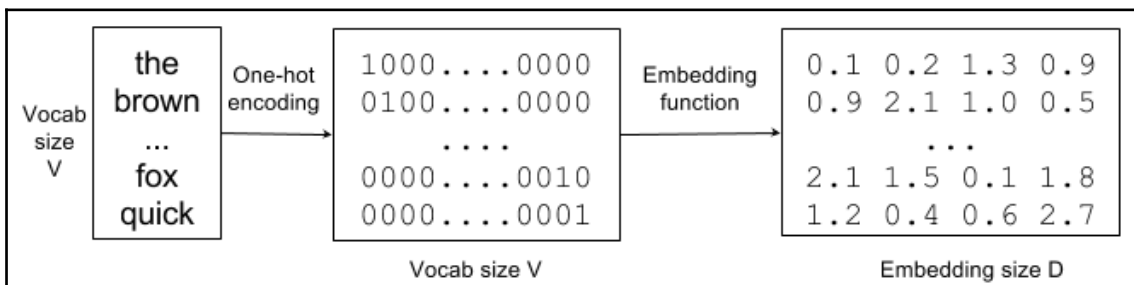

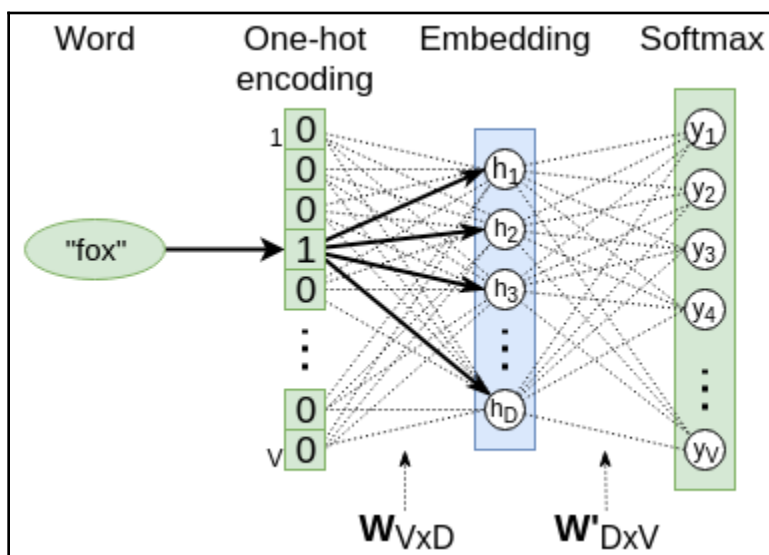
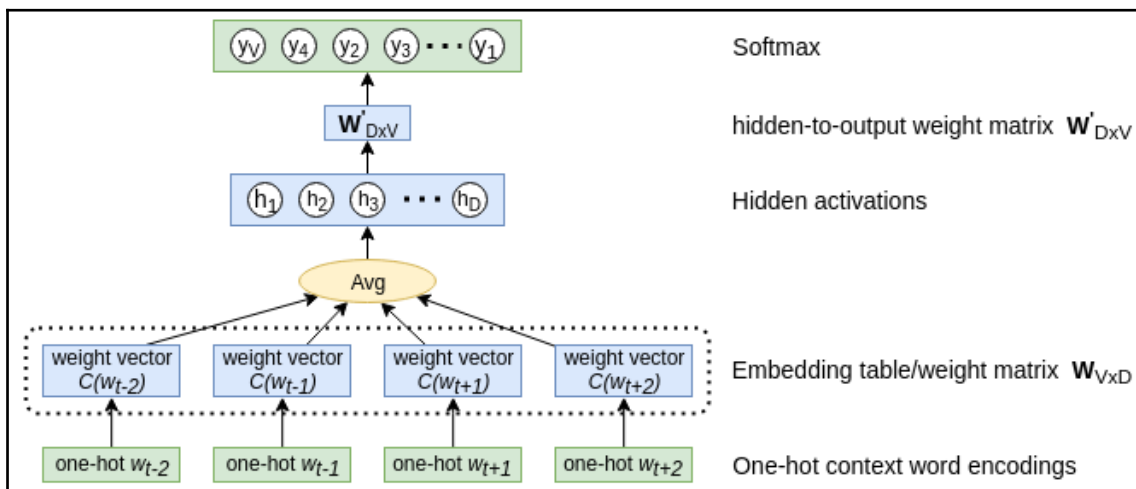
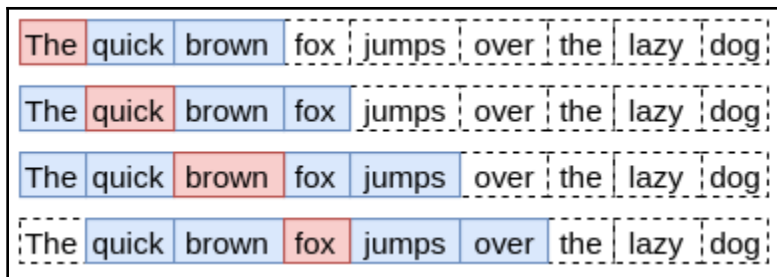

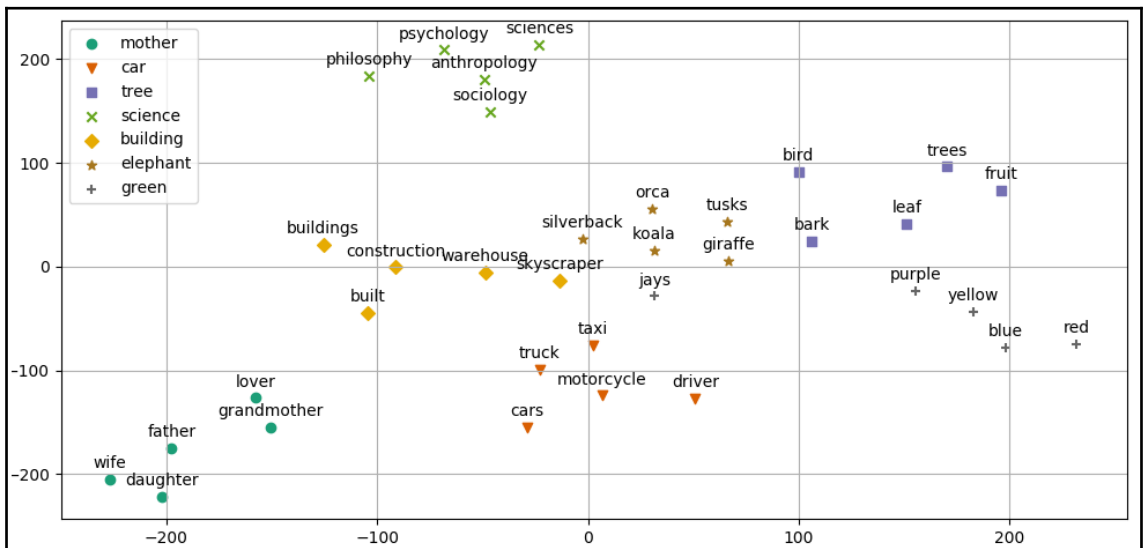
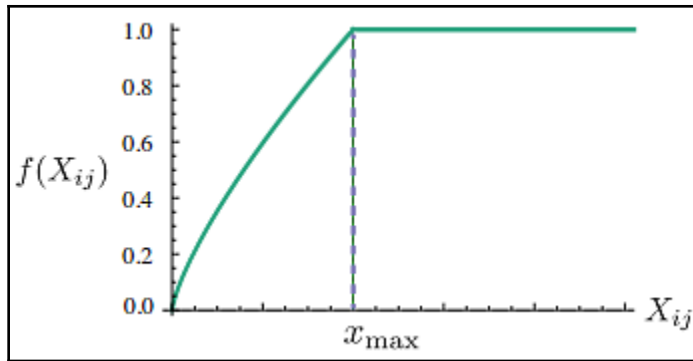

Chapter 7: Understanding Recurrent Networks

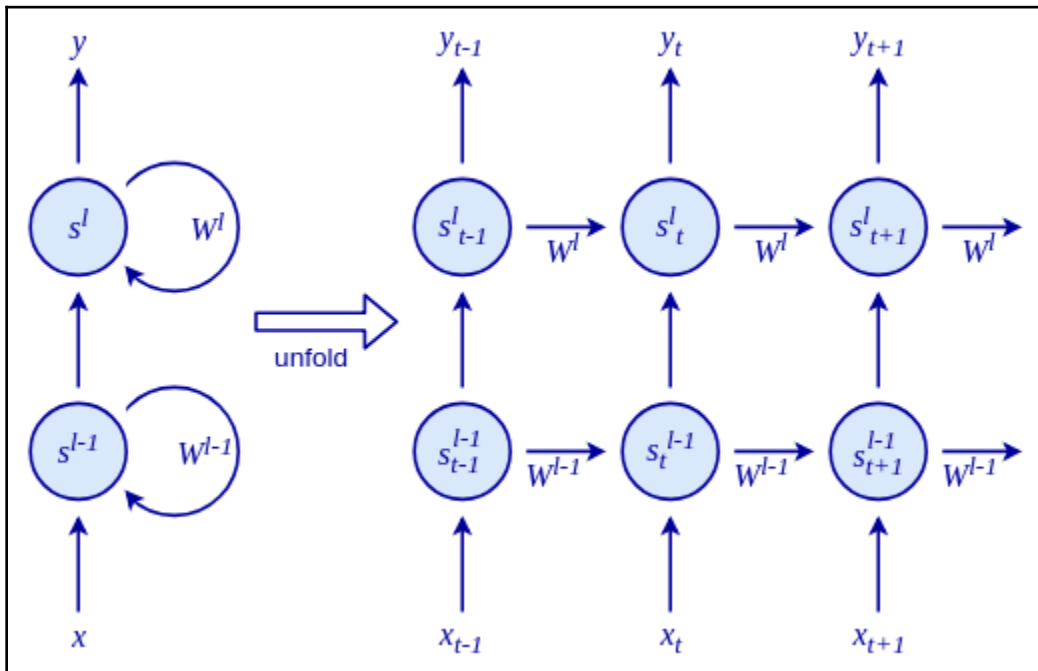
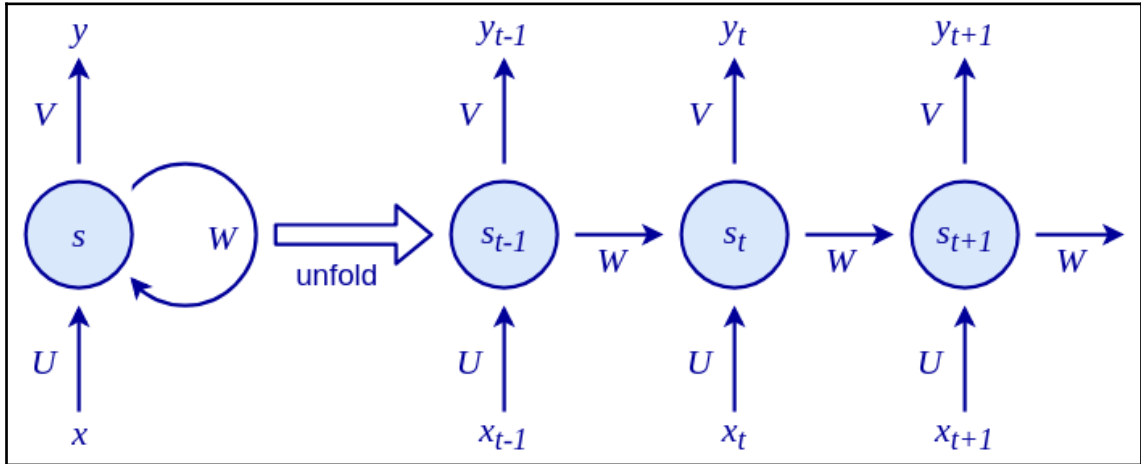

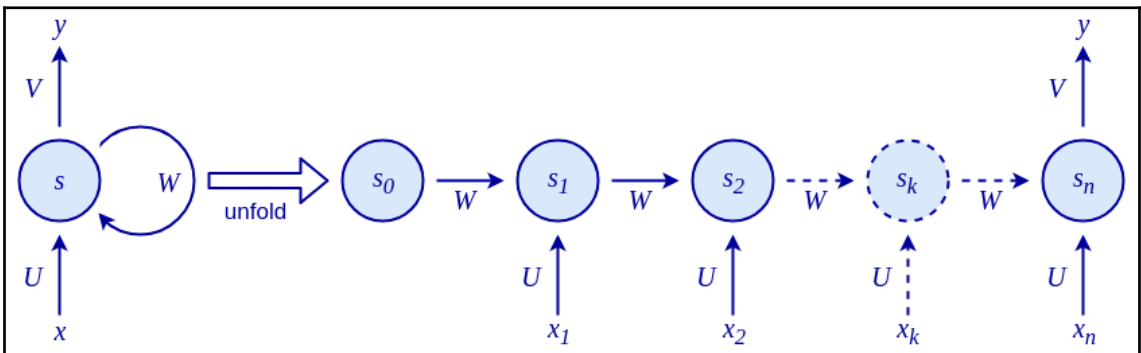
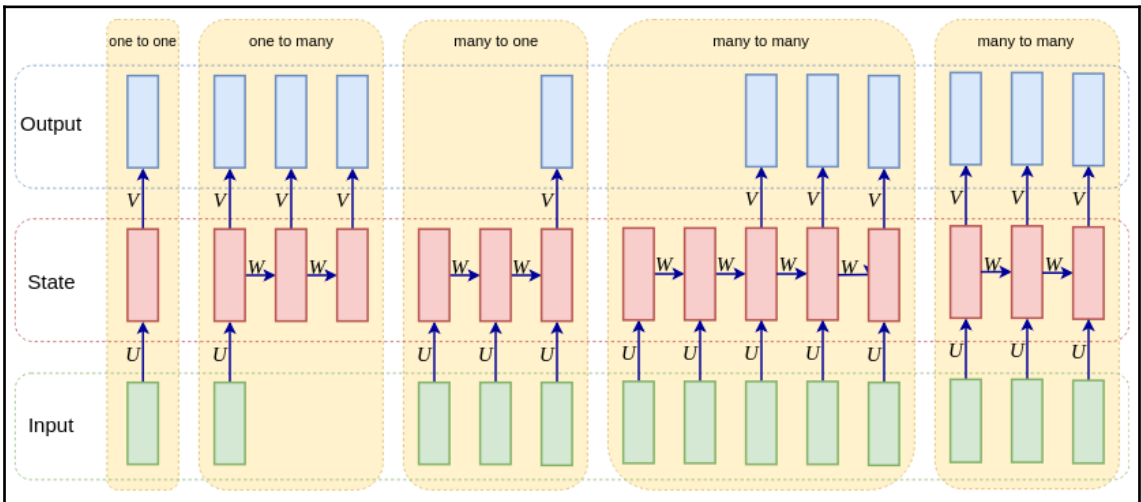
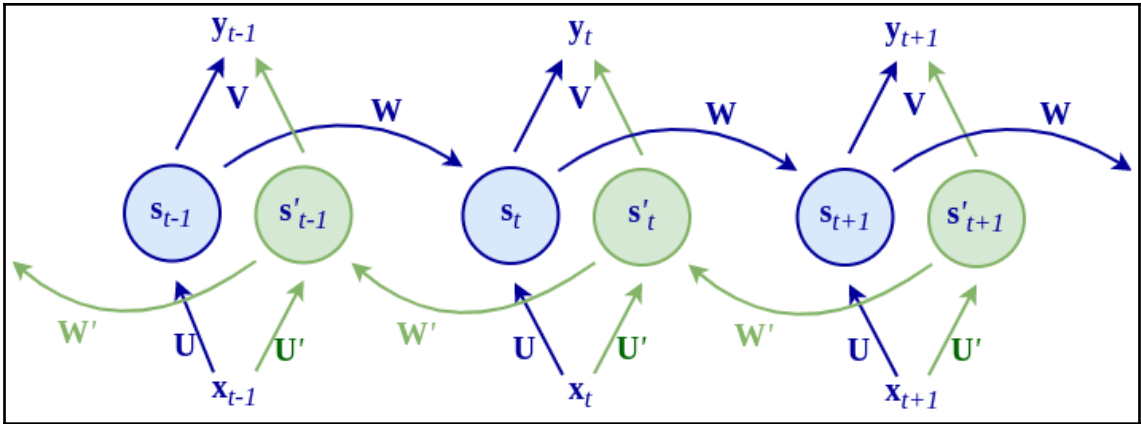

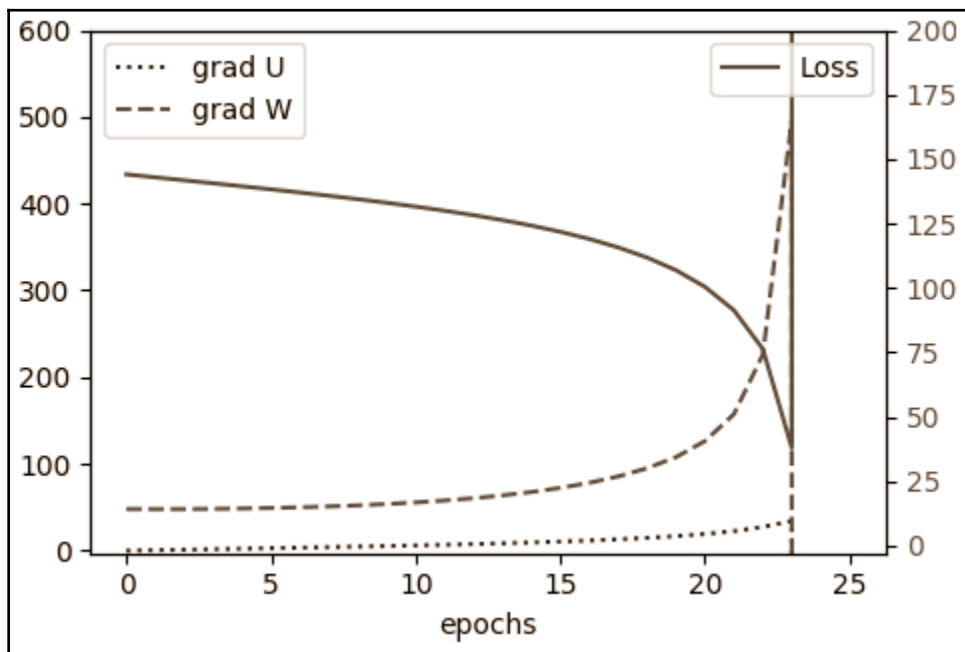
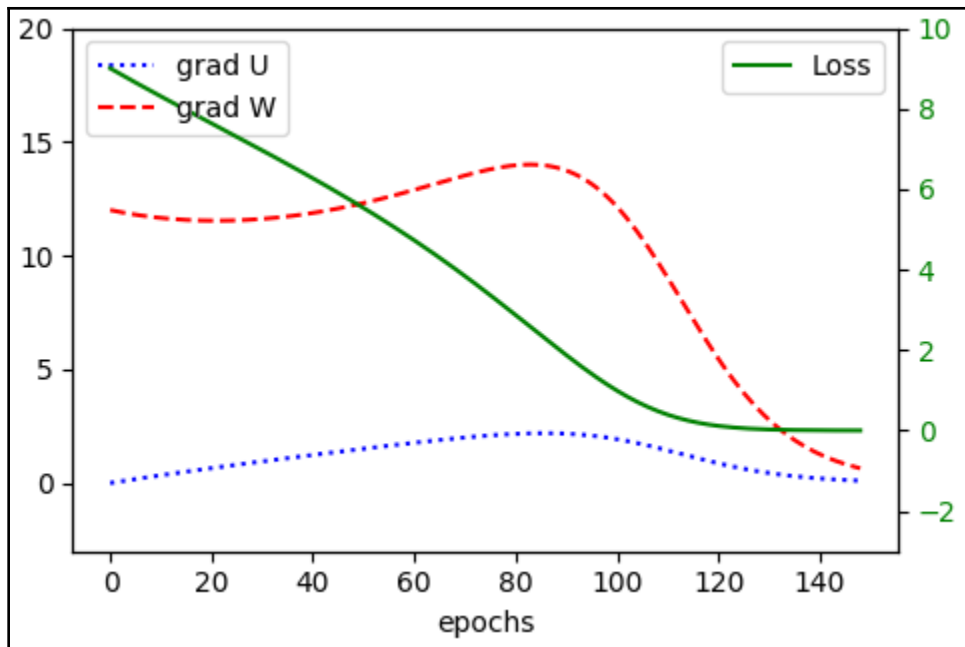

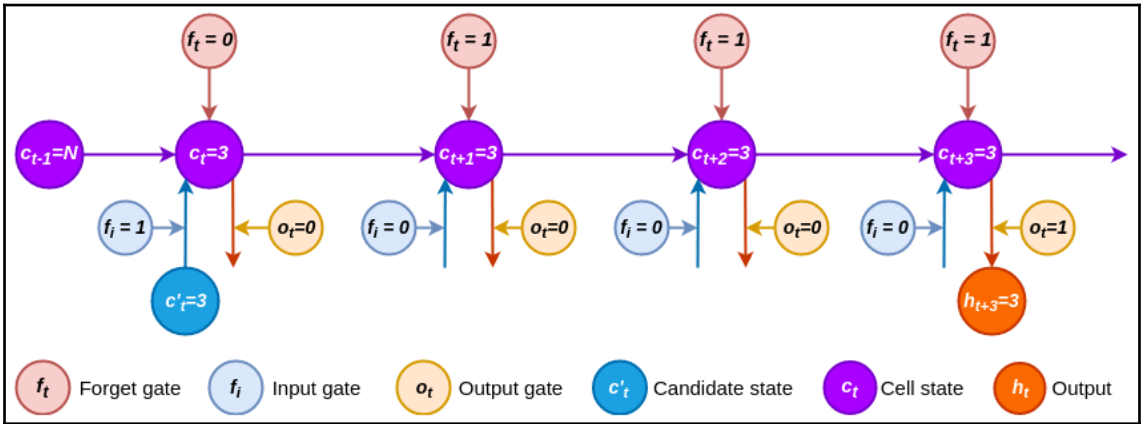
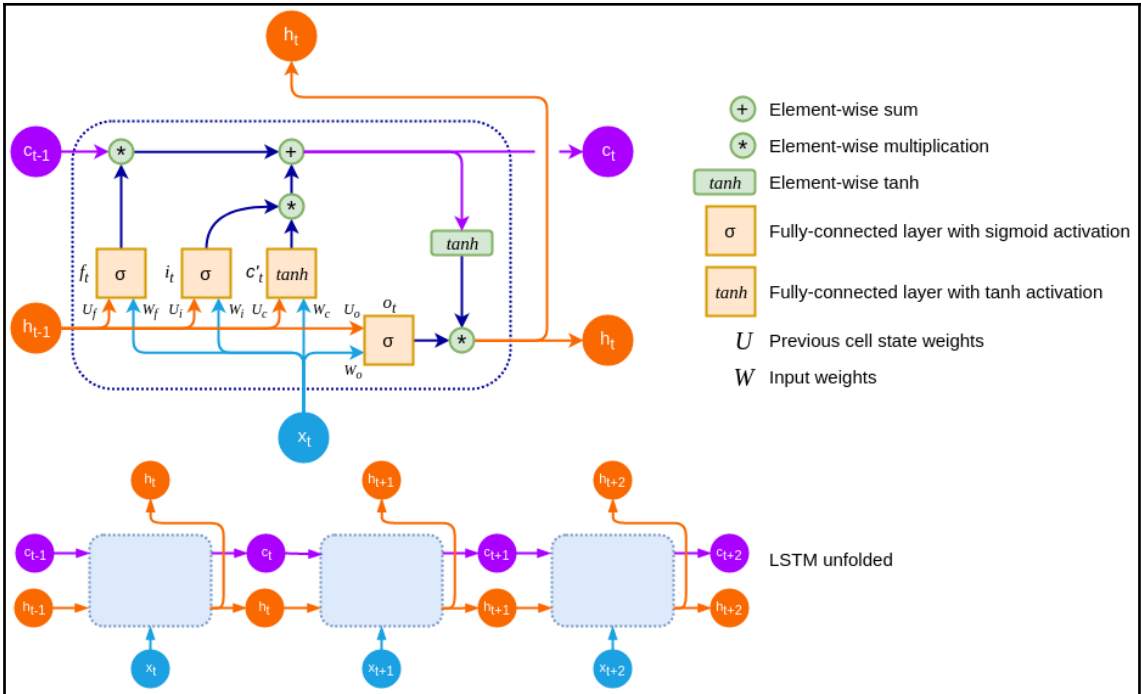

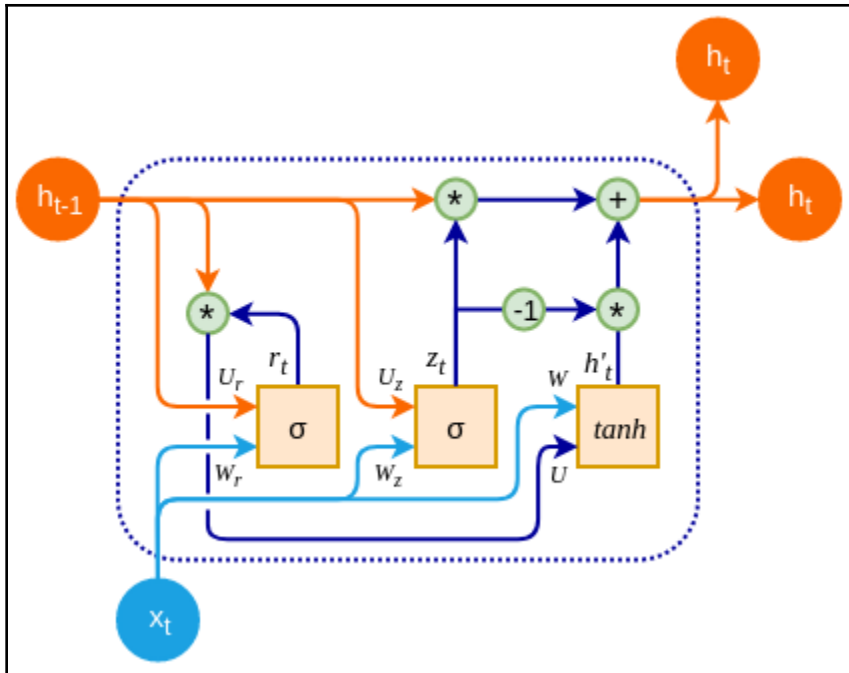
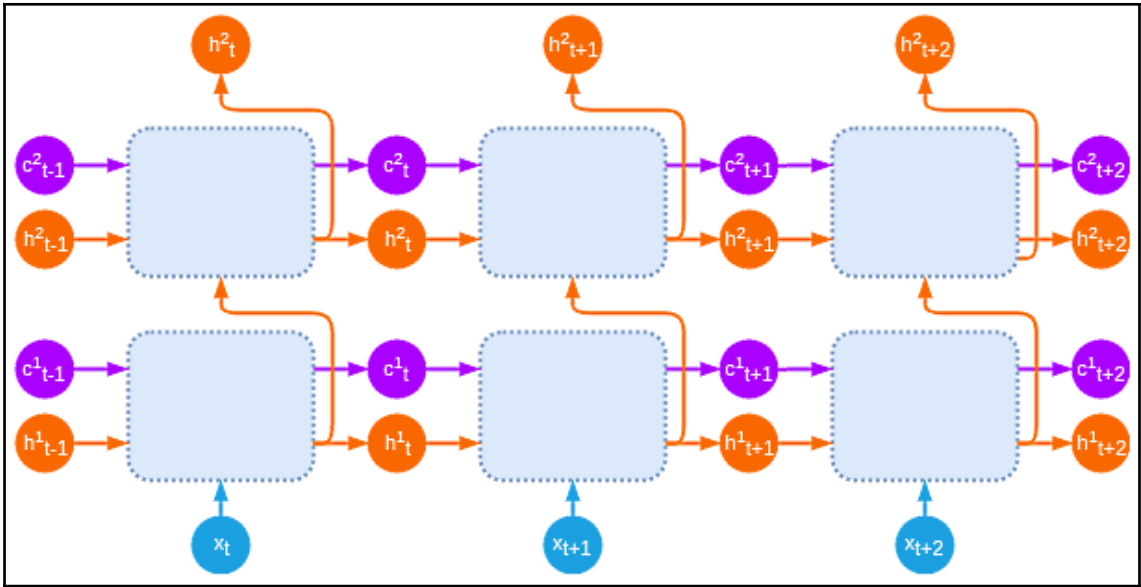

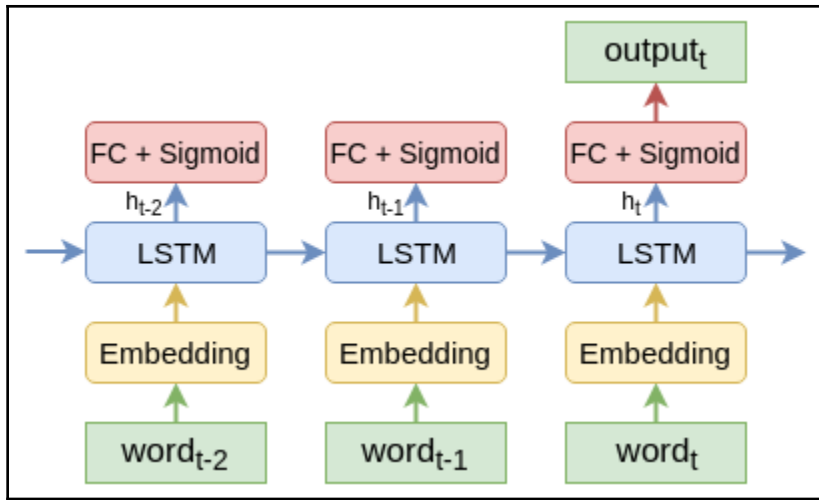

Chapter 8: Sequence-to-Sequence Models and Attention

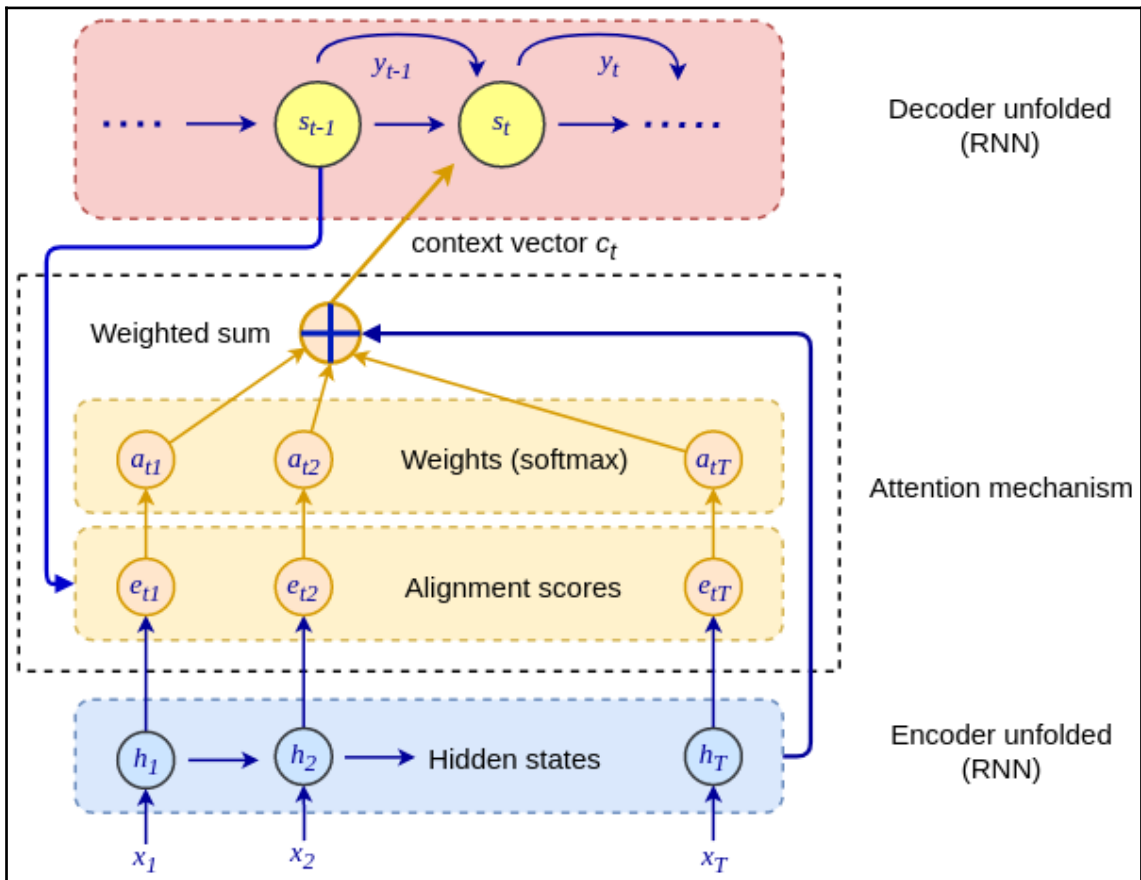
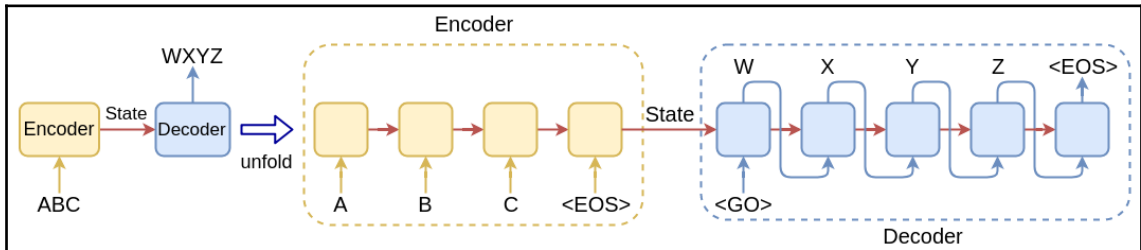

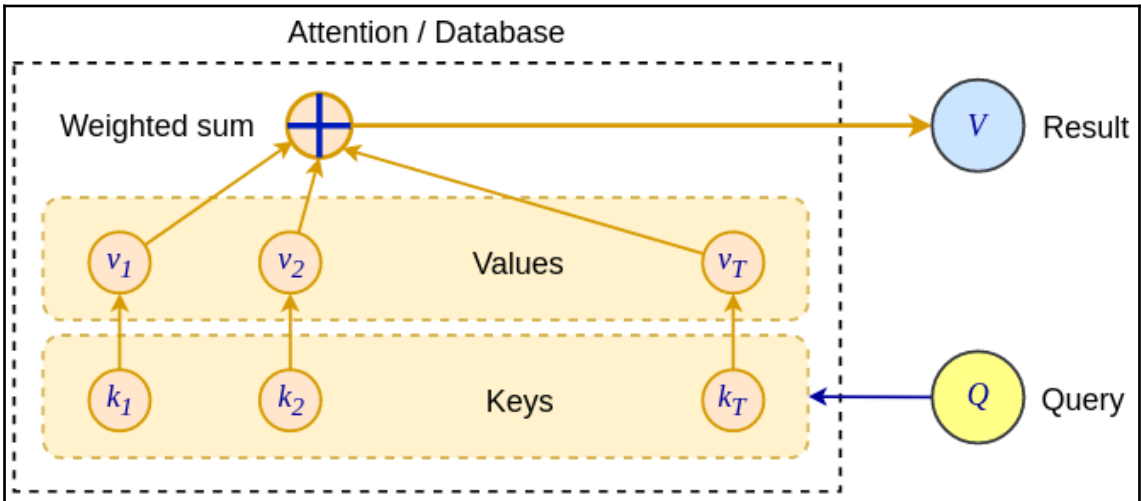
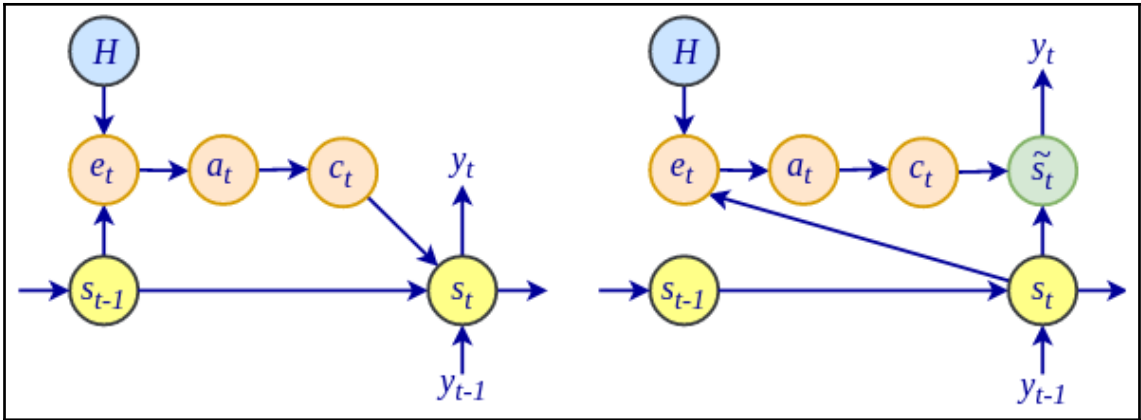

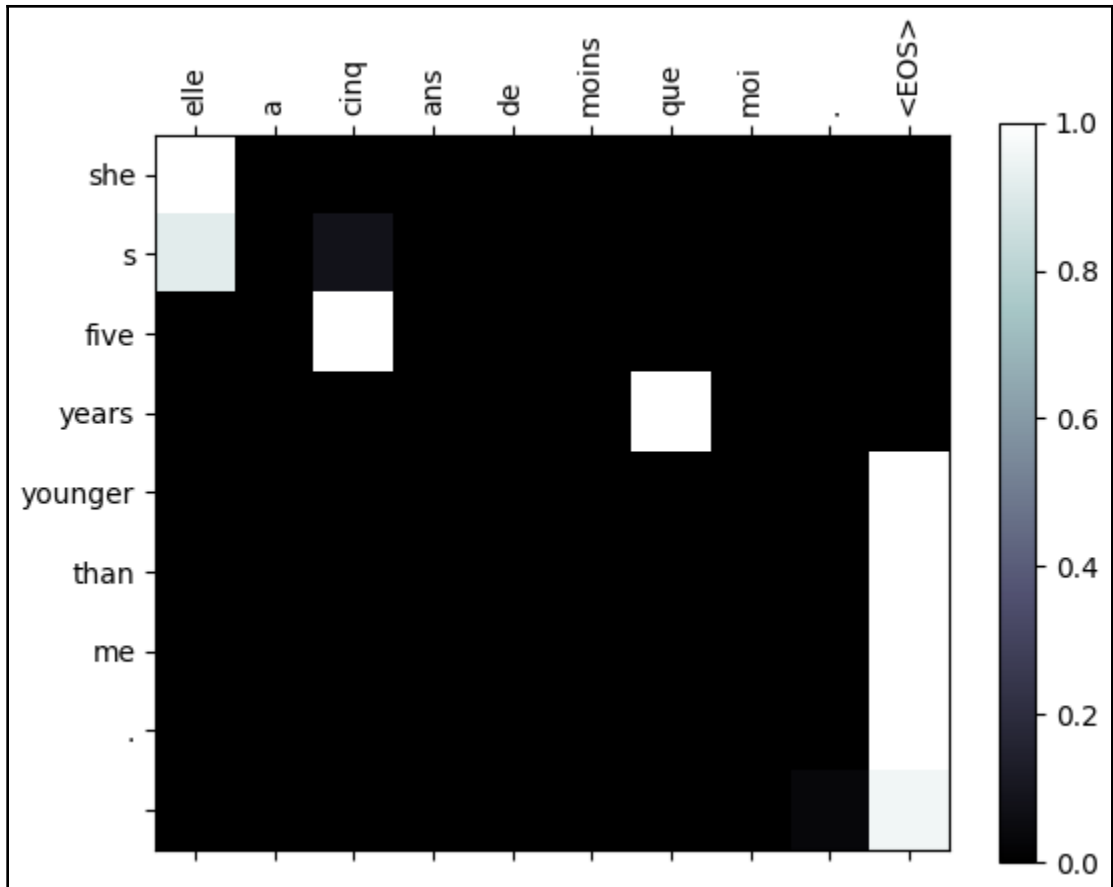

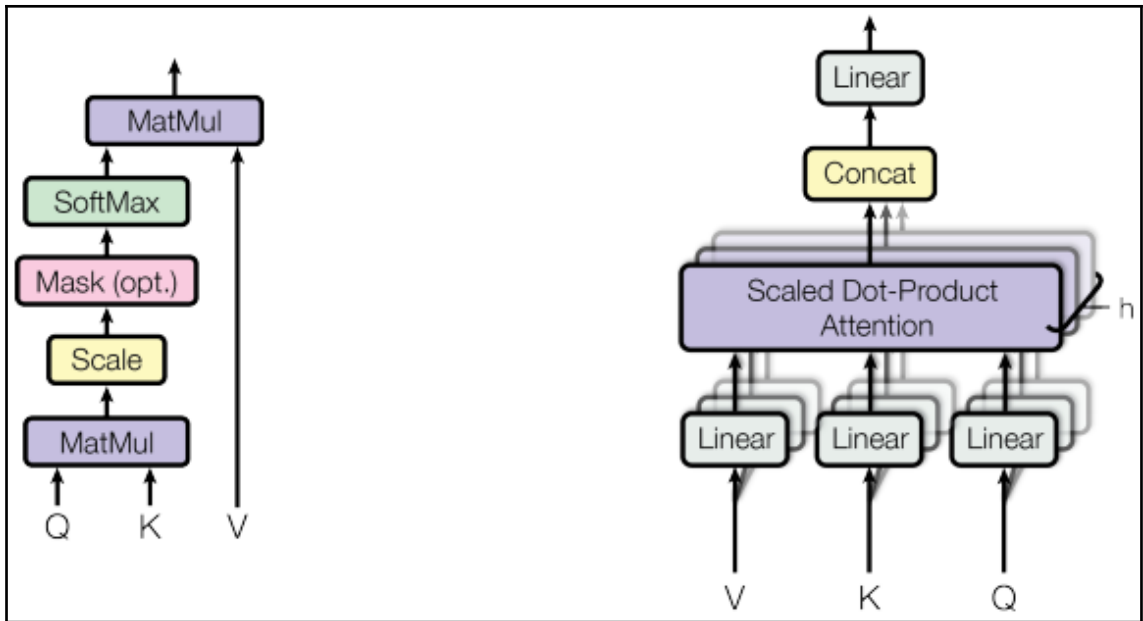

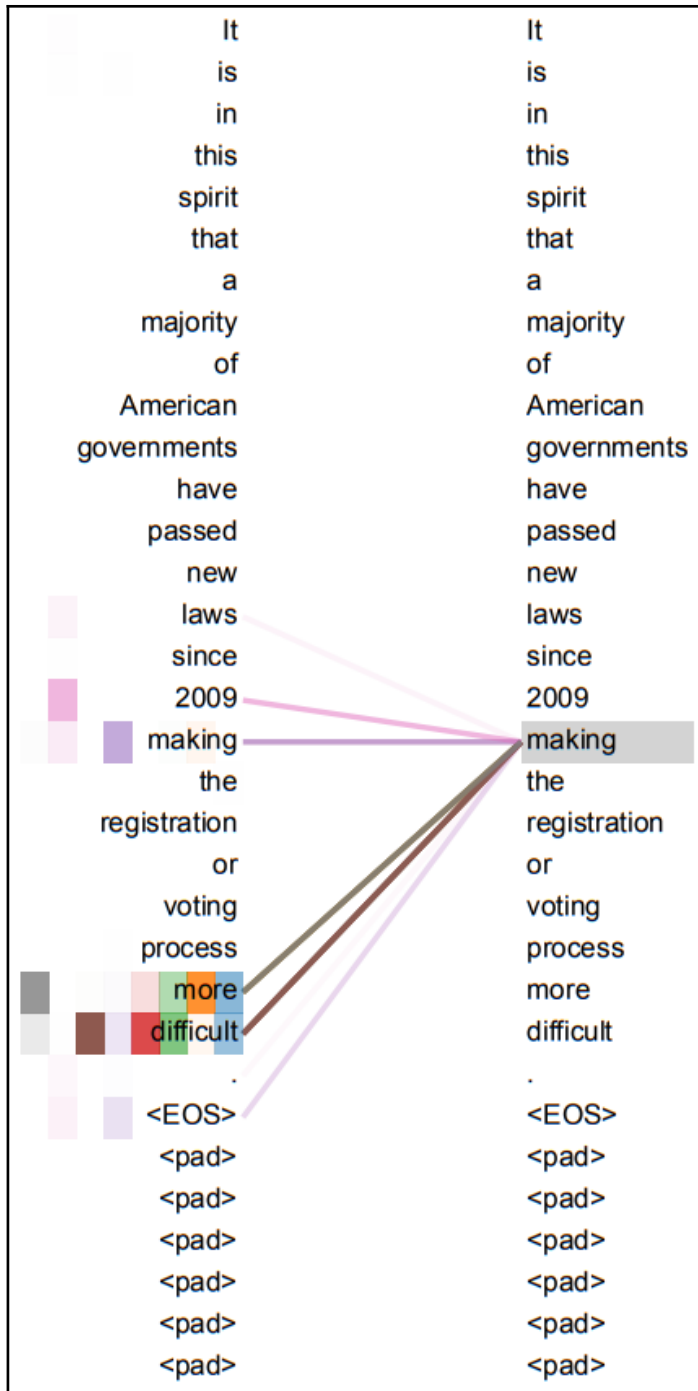

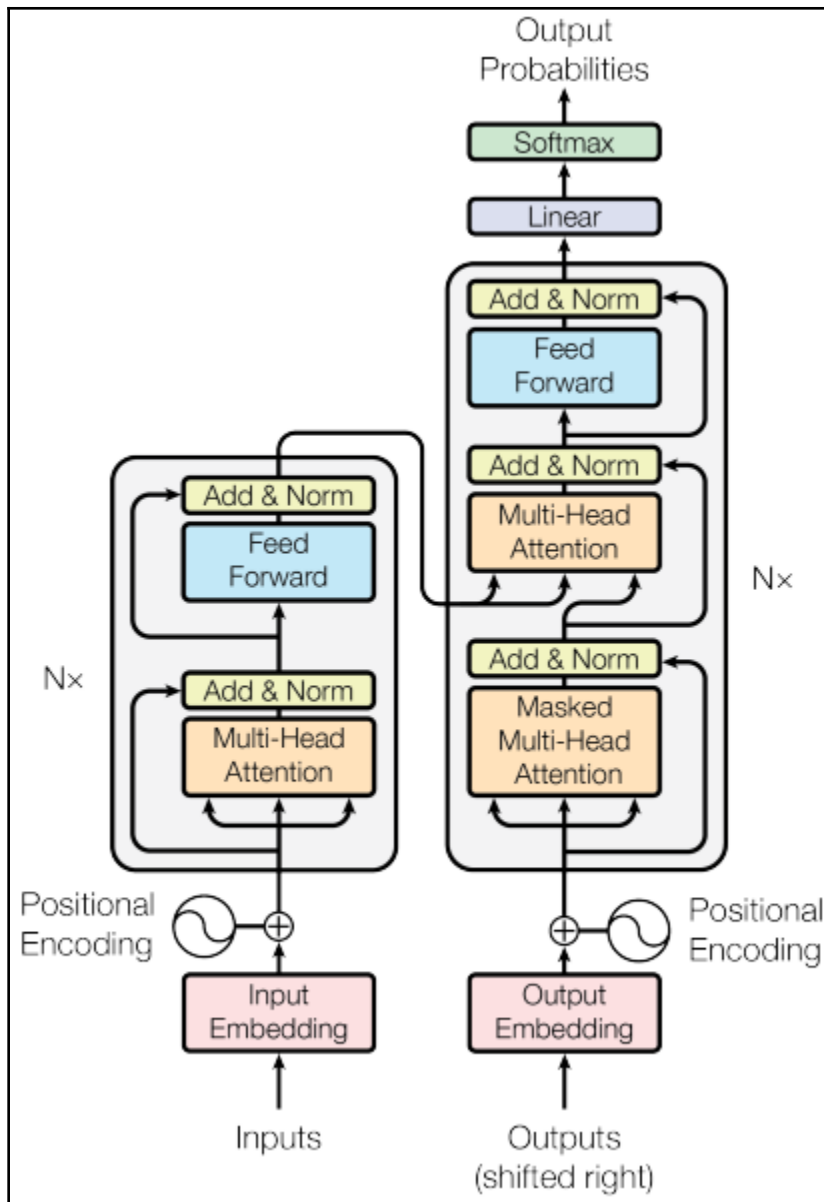

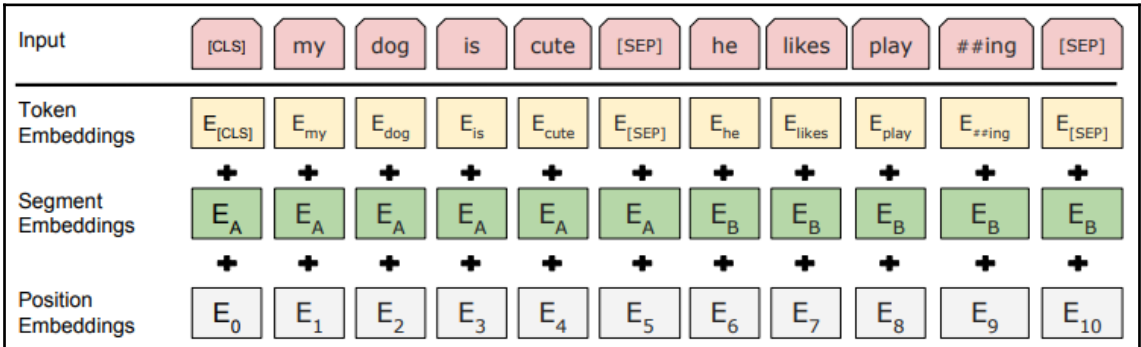
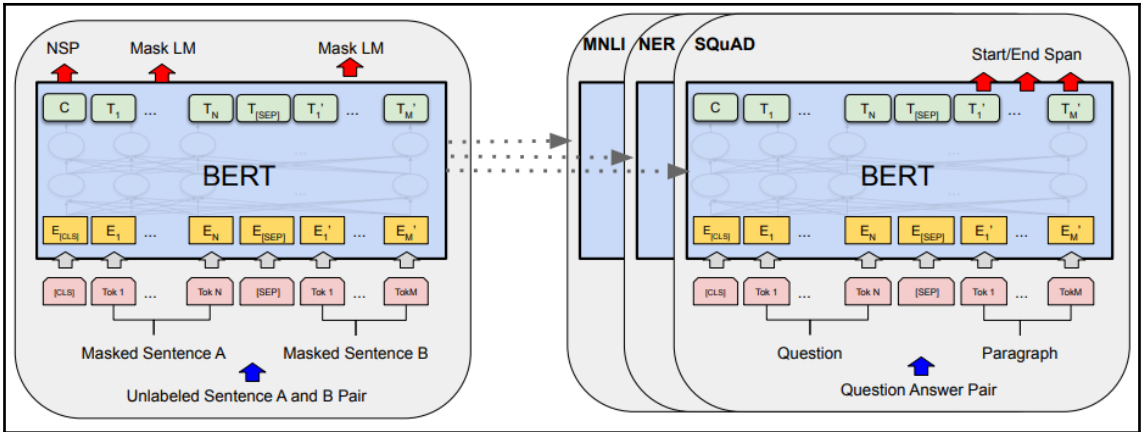

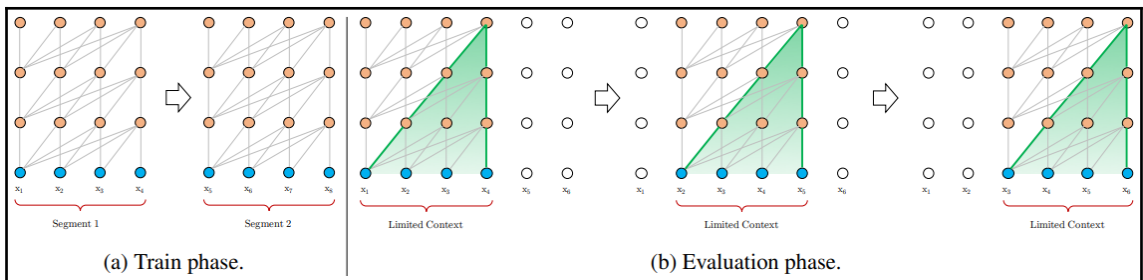
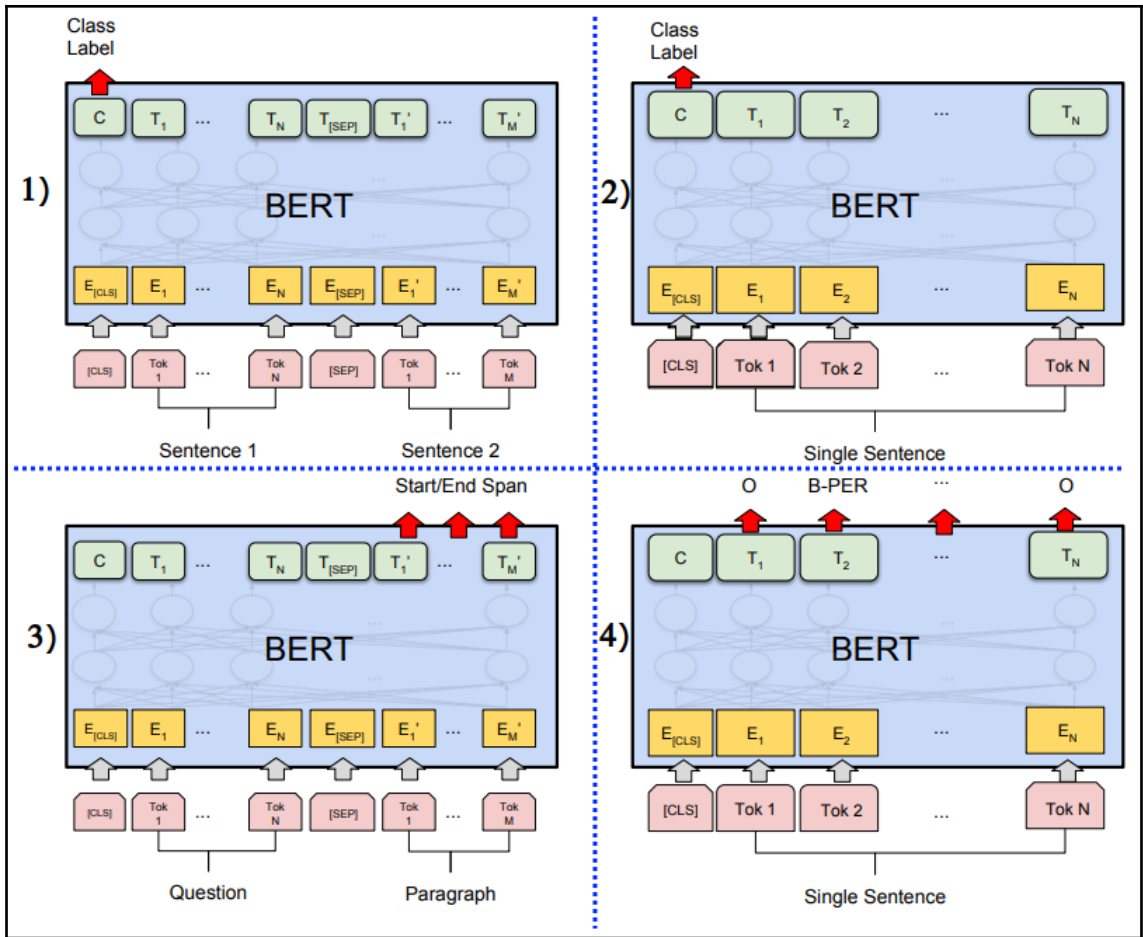

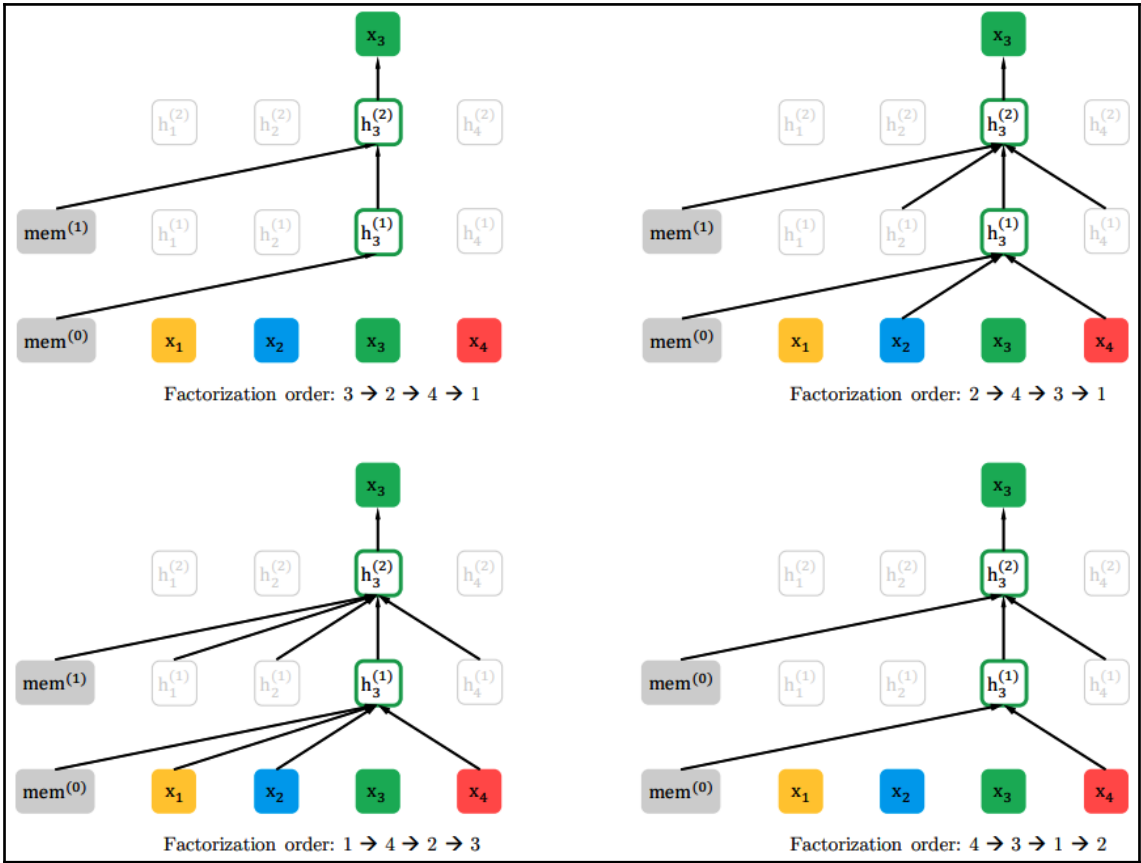
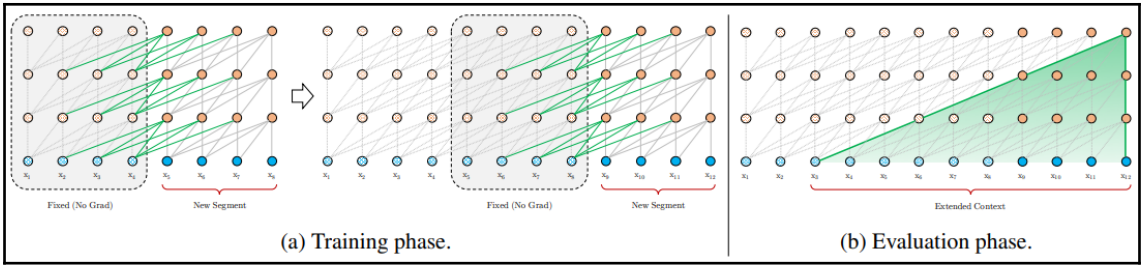

Chapter 9: Emerging Neural Network Designs

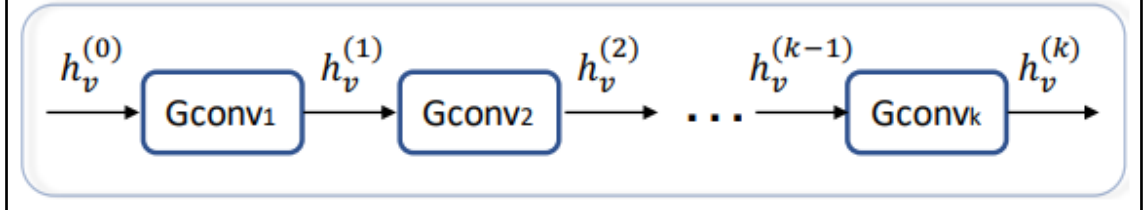
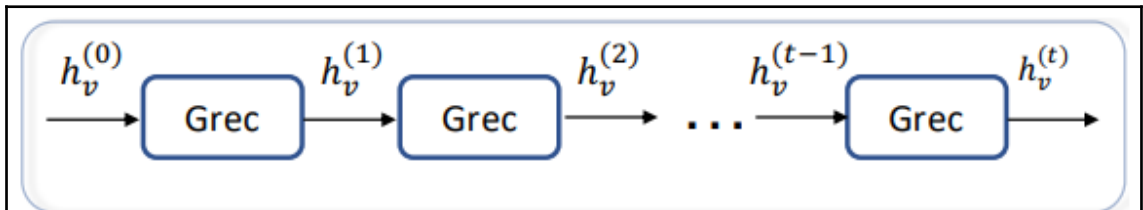
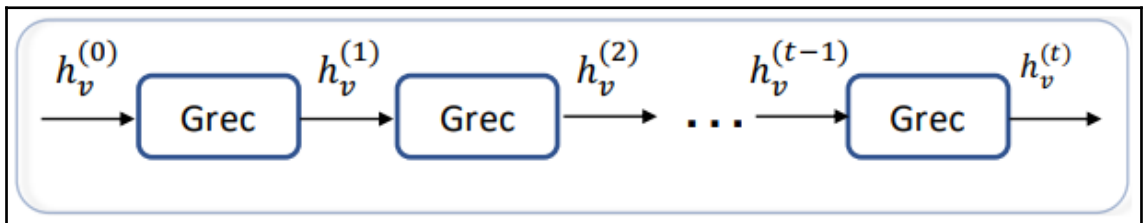
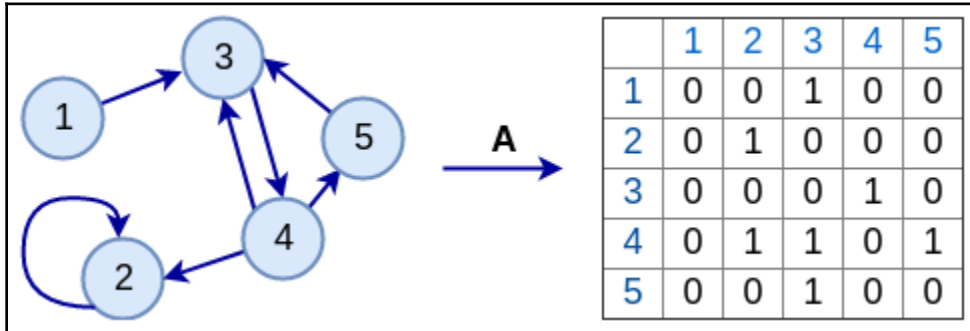

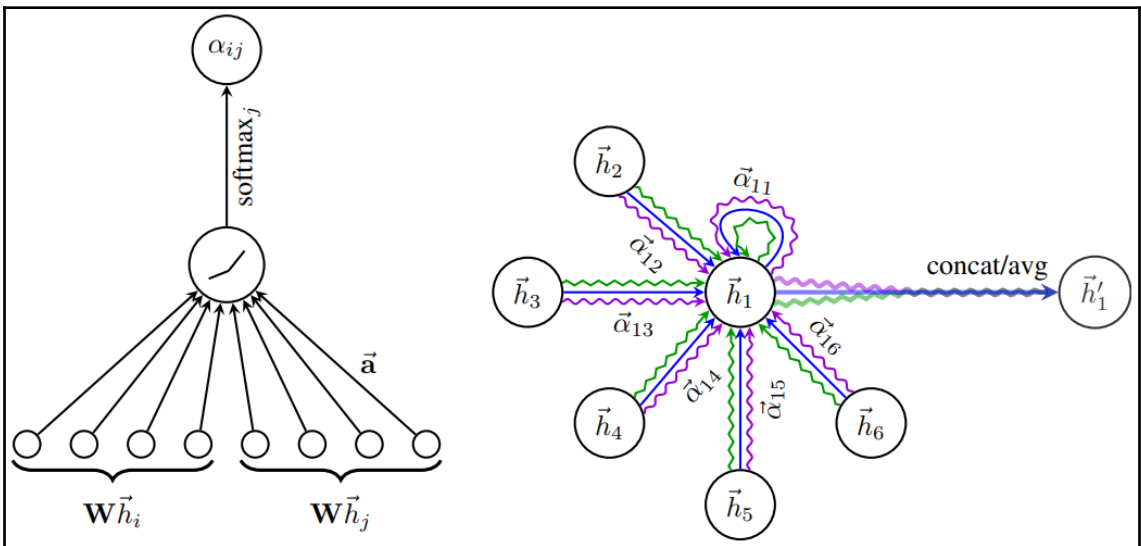
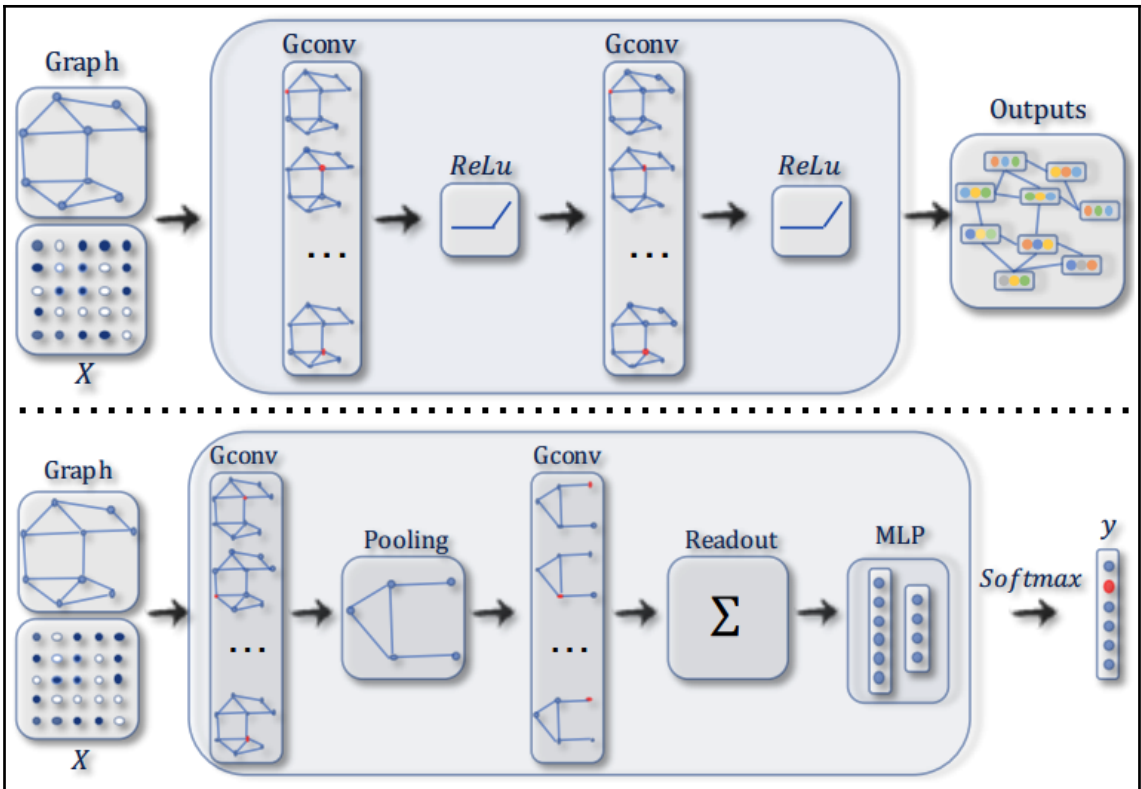

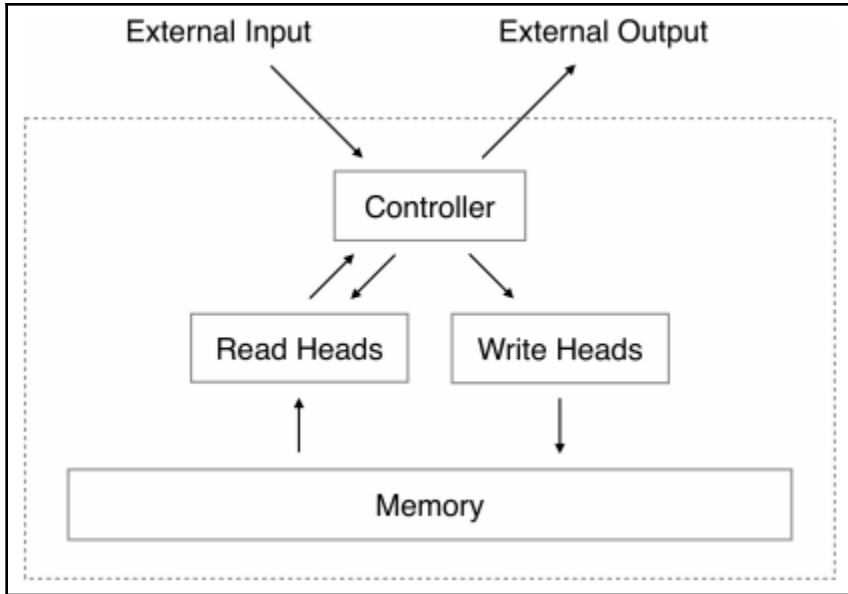
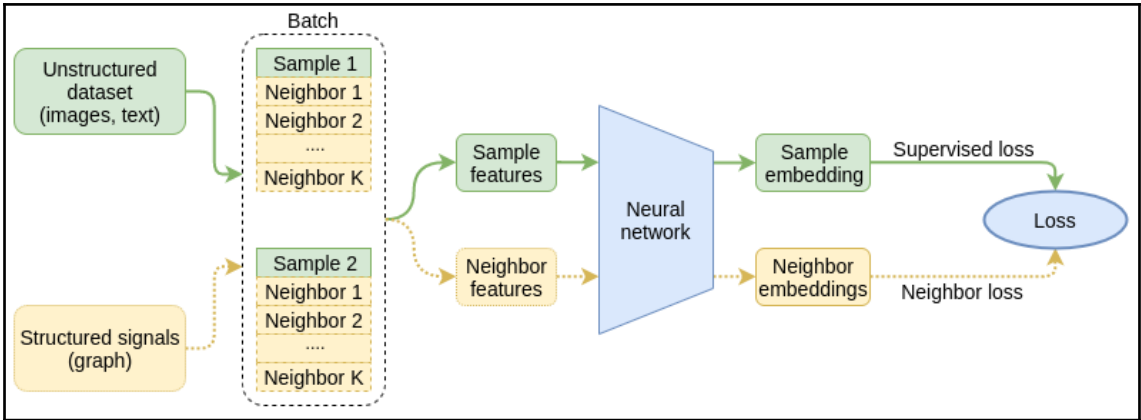
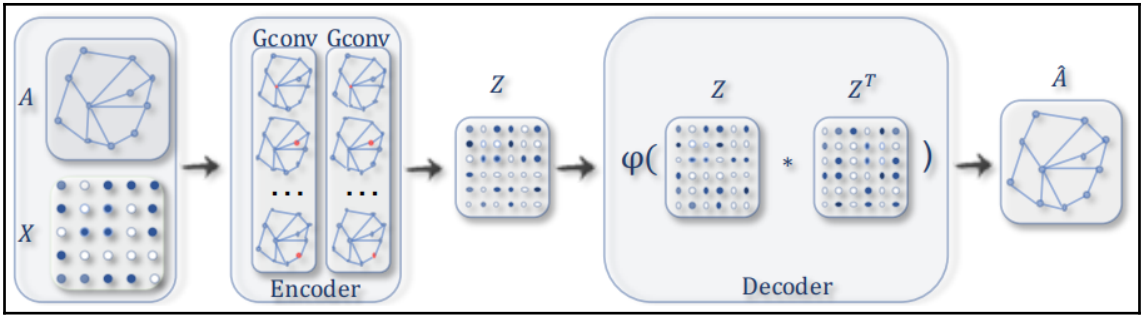

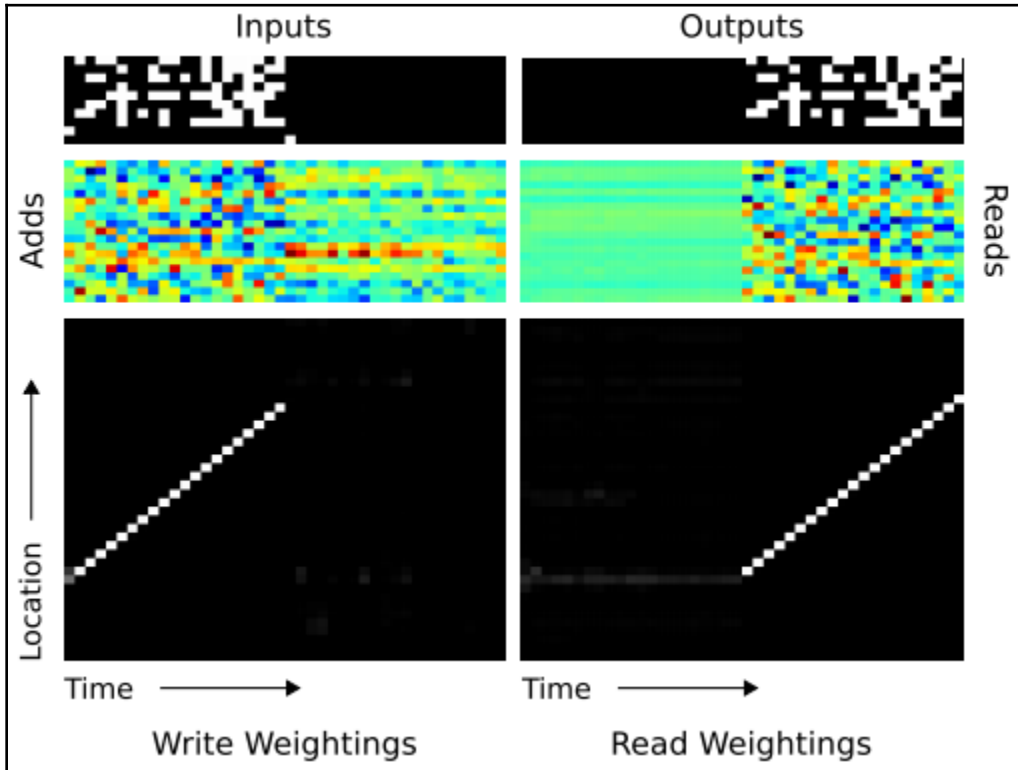
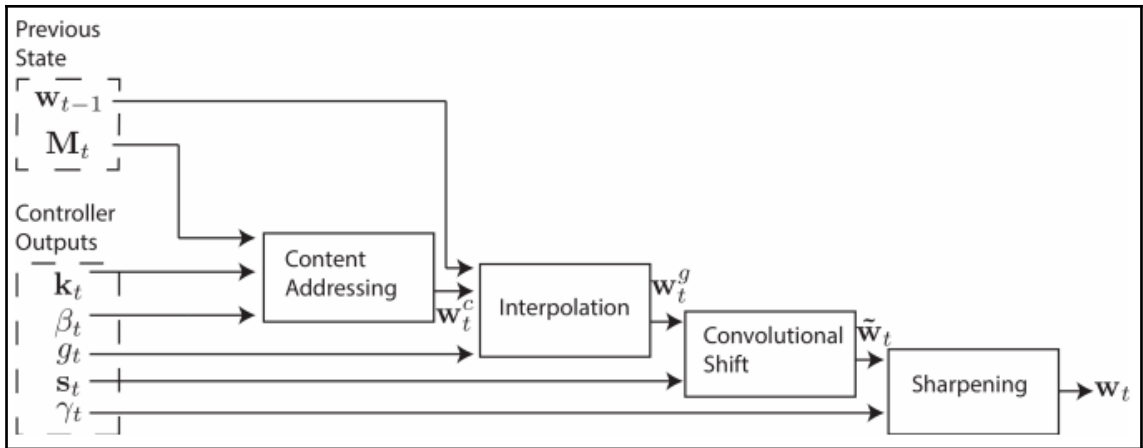

Chapter 10: Meta Learning

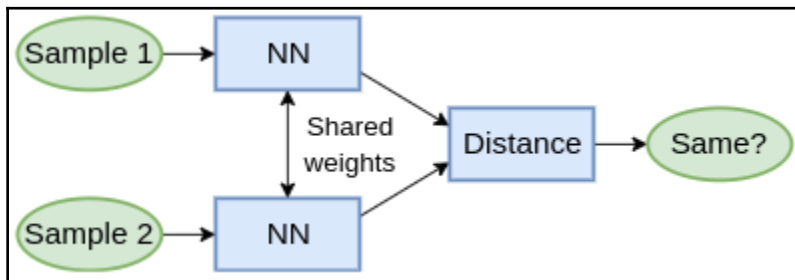
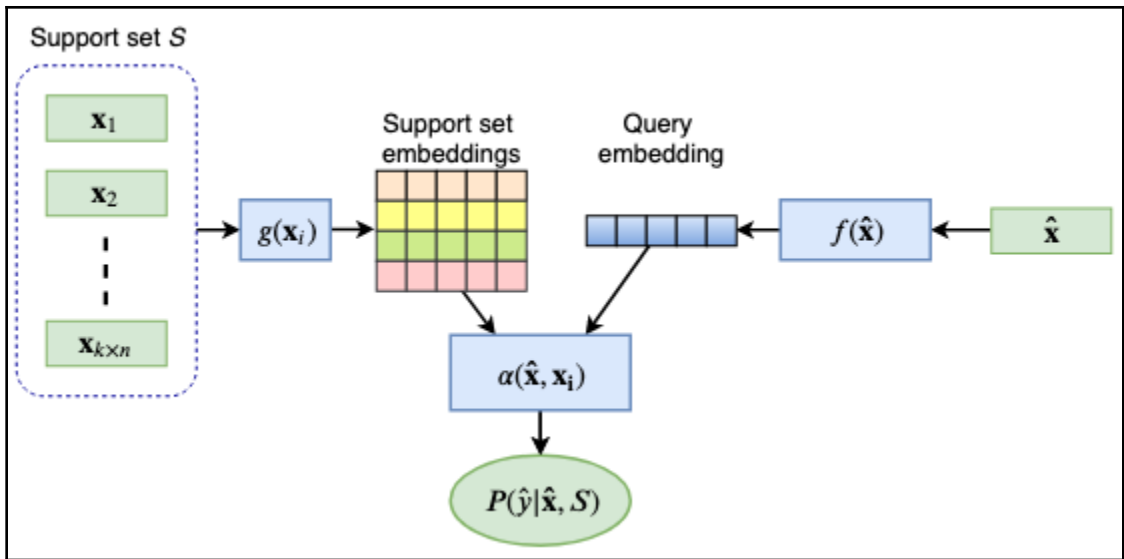
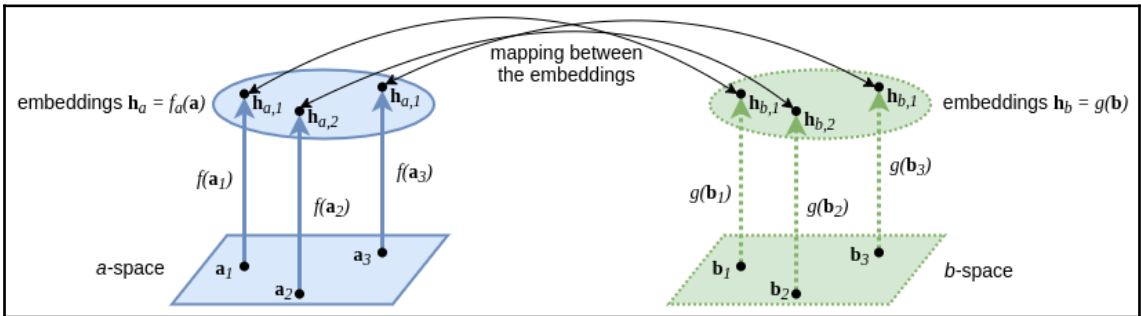

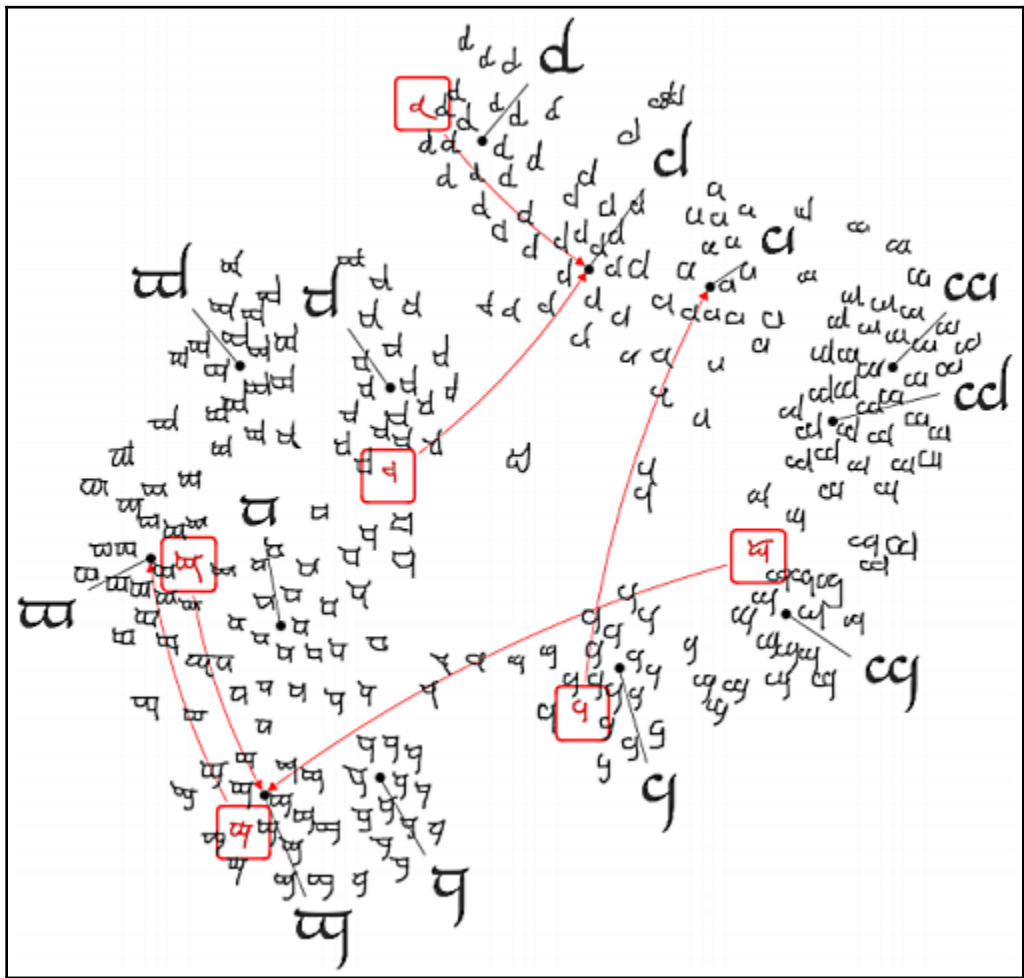
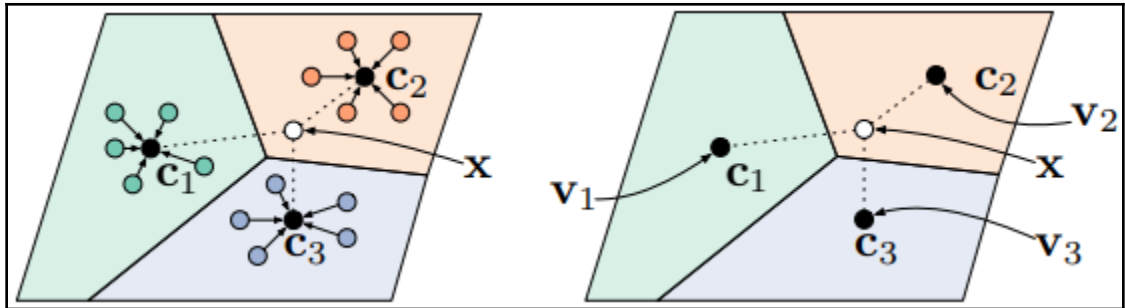

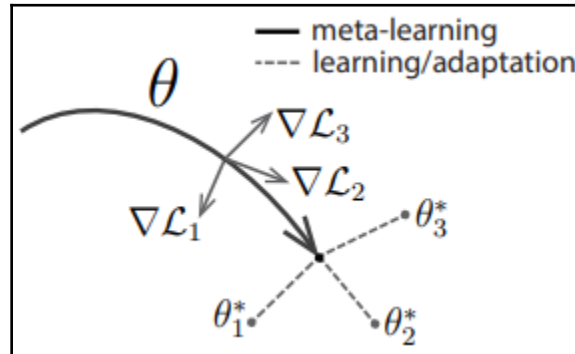
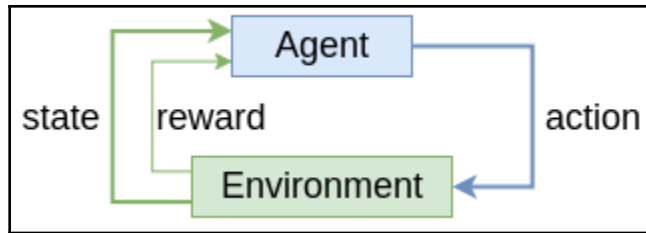

Chapter 11: Deep Learning for Autonomous Vehicles

