

Chapter 2: Data Processing

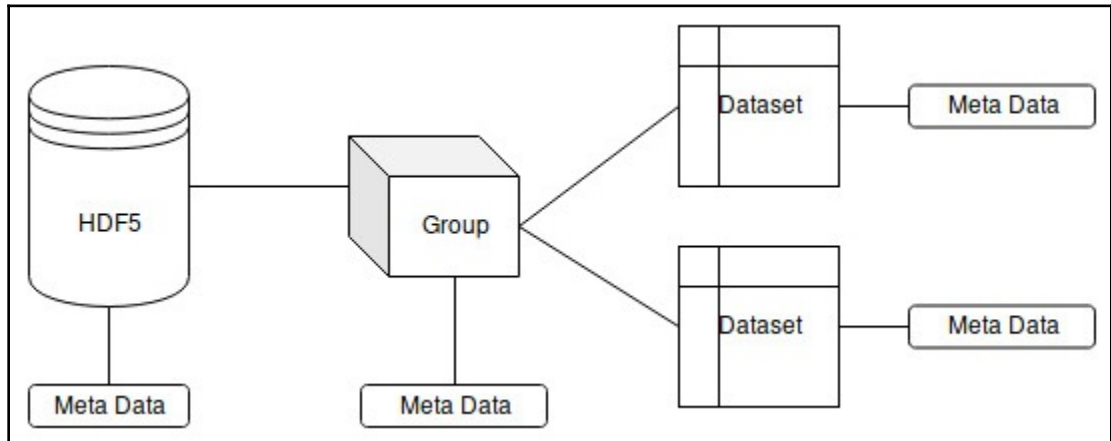

Chapter 3: Measuring Performance and Selecting Models

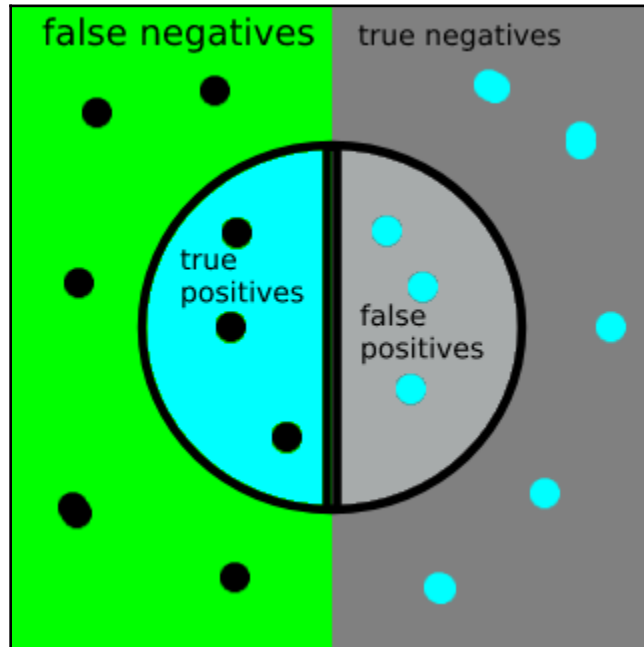

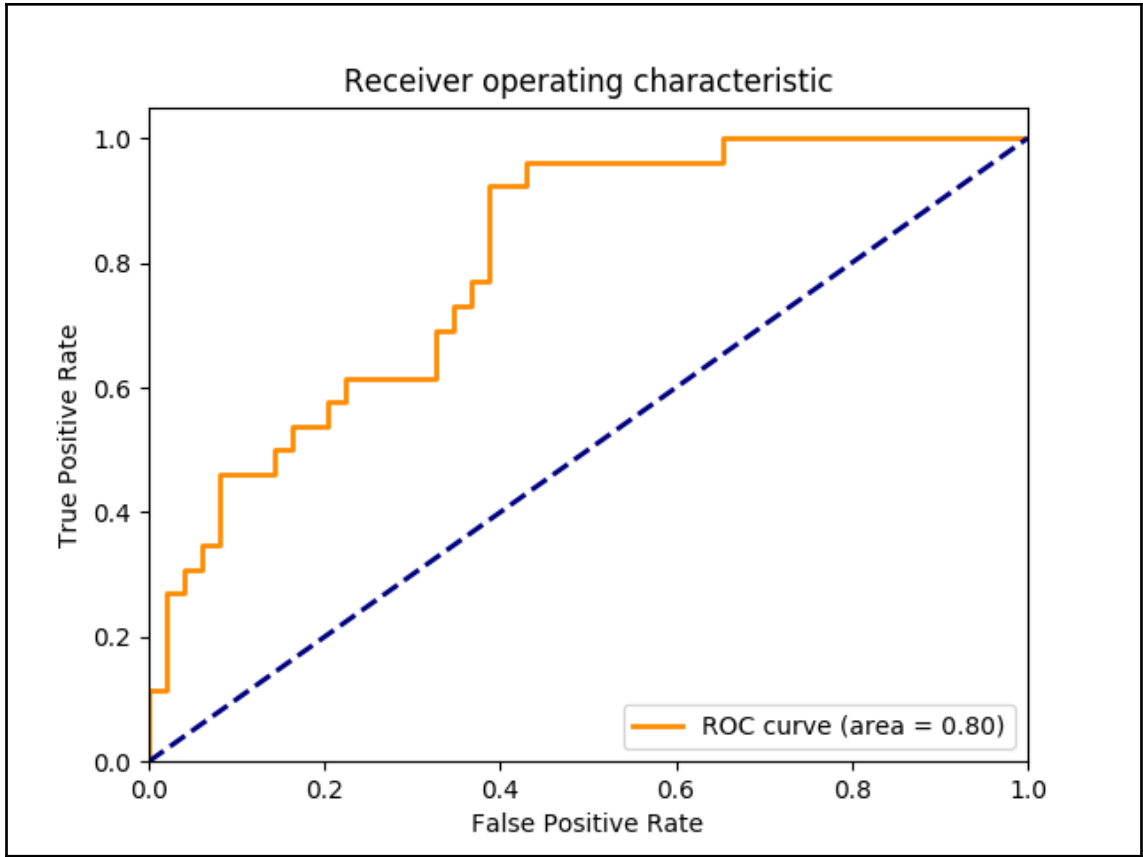

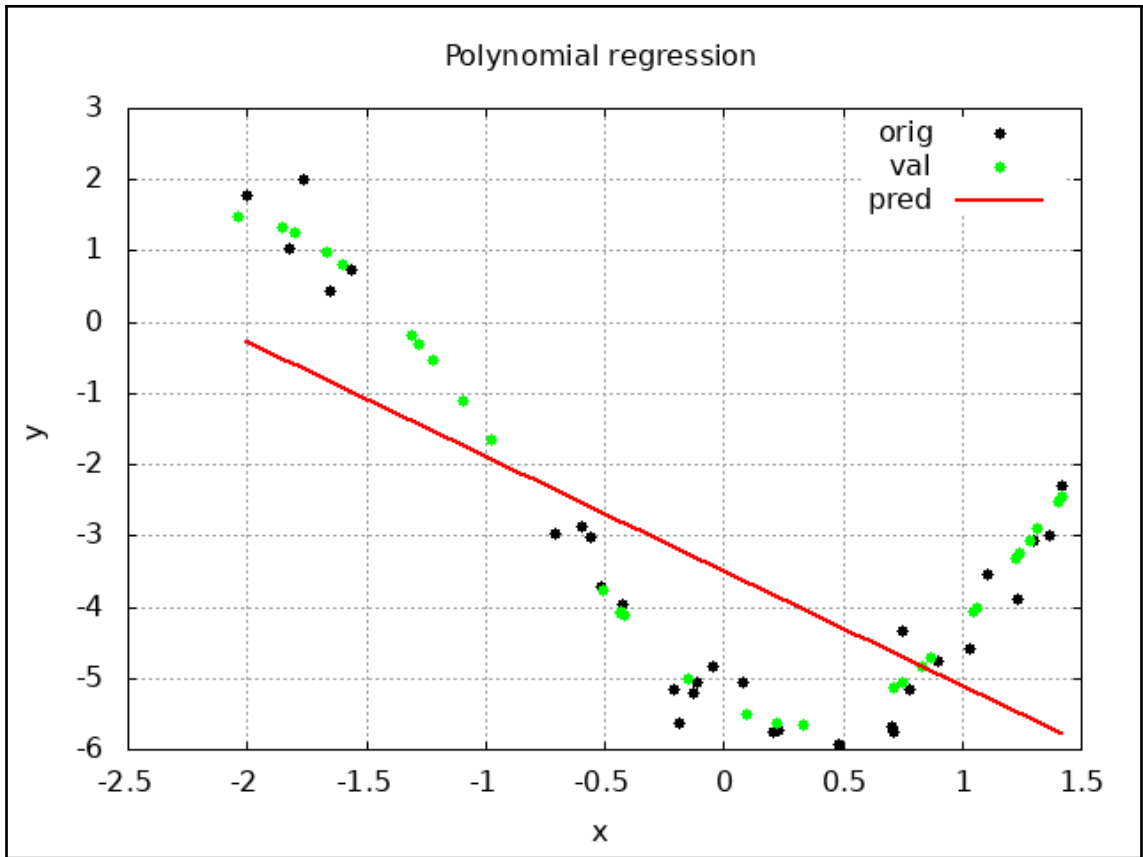

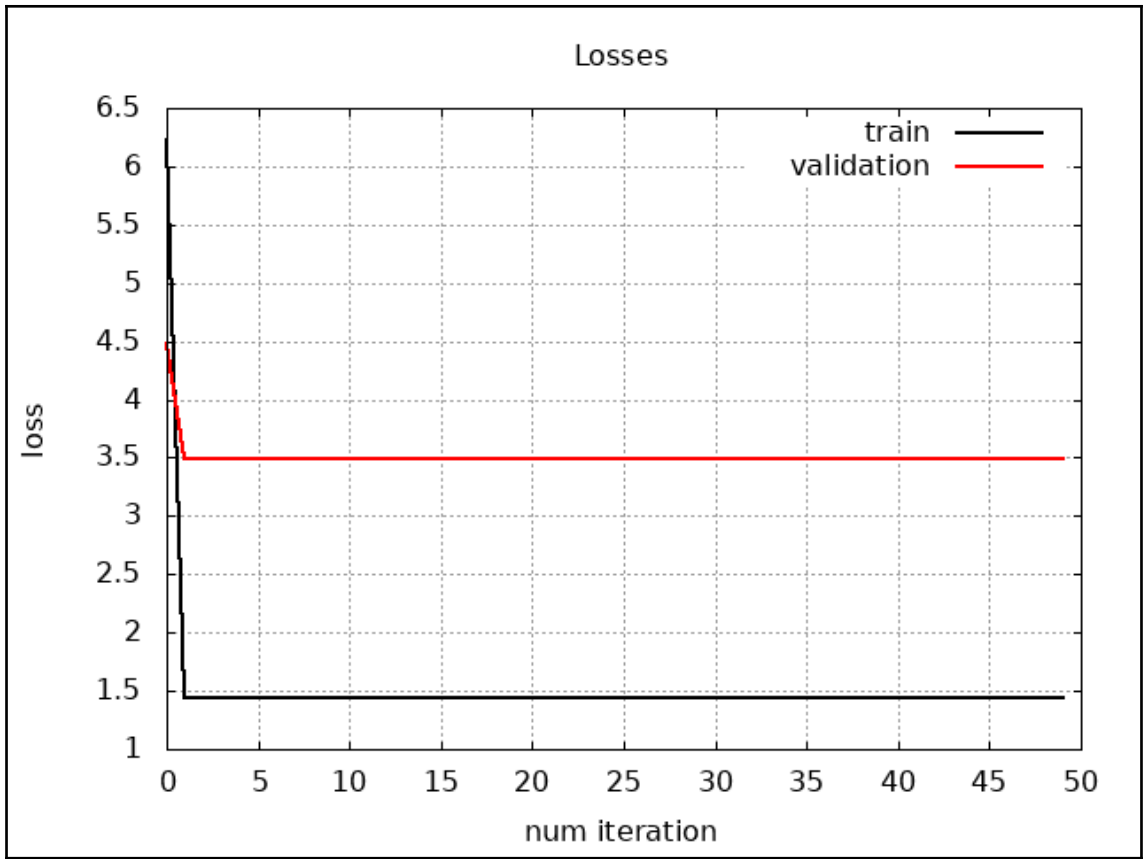

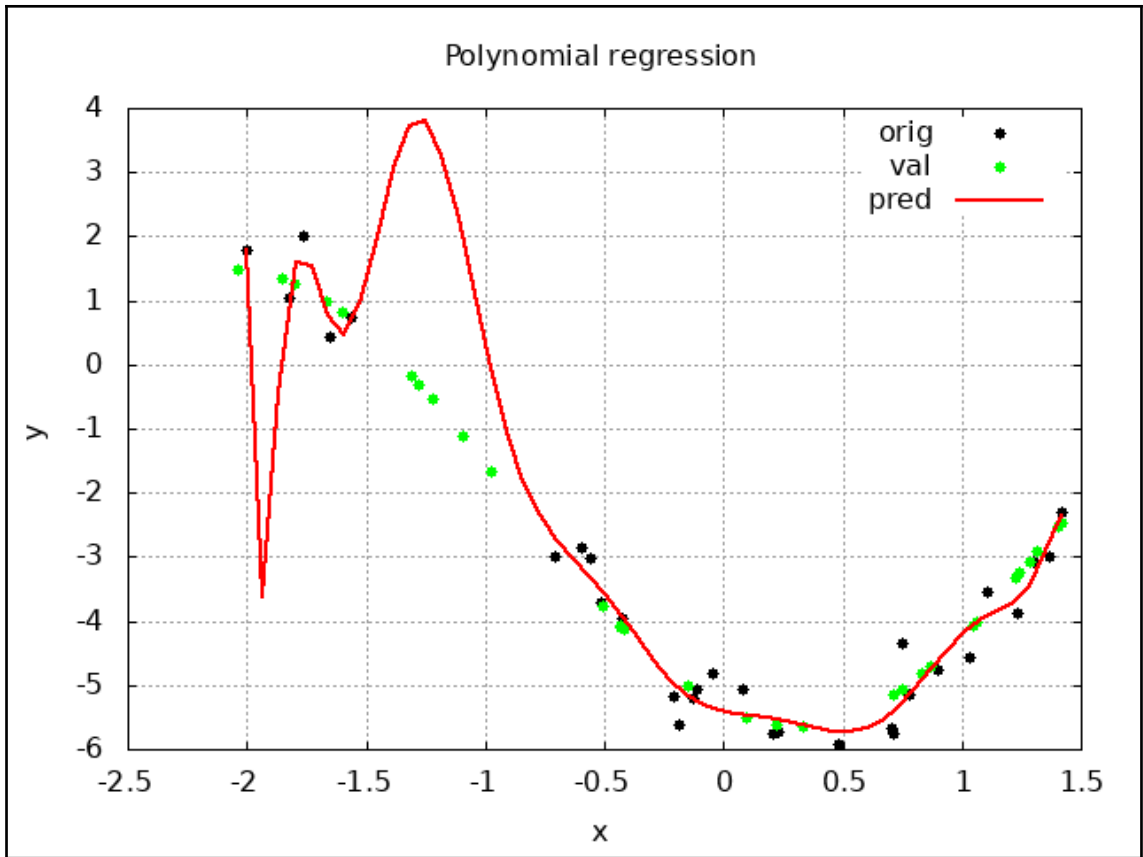

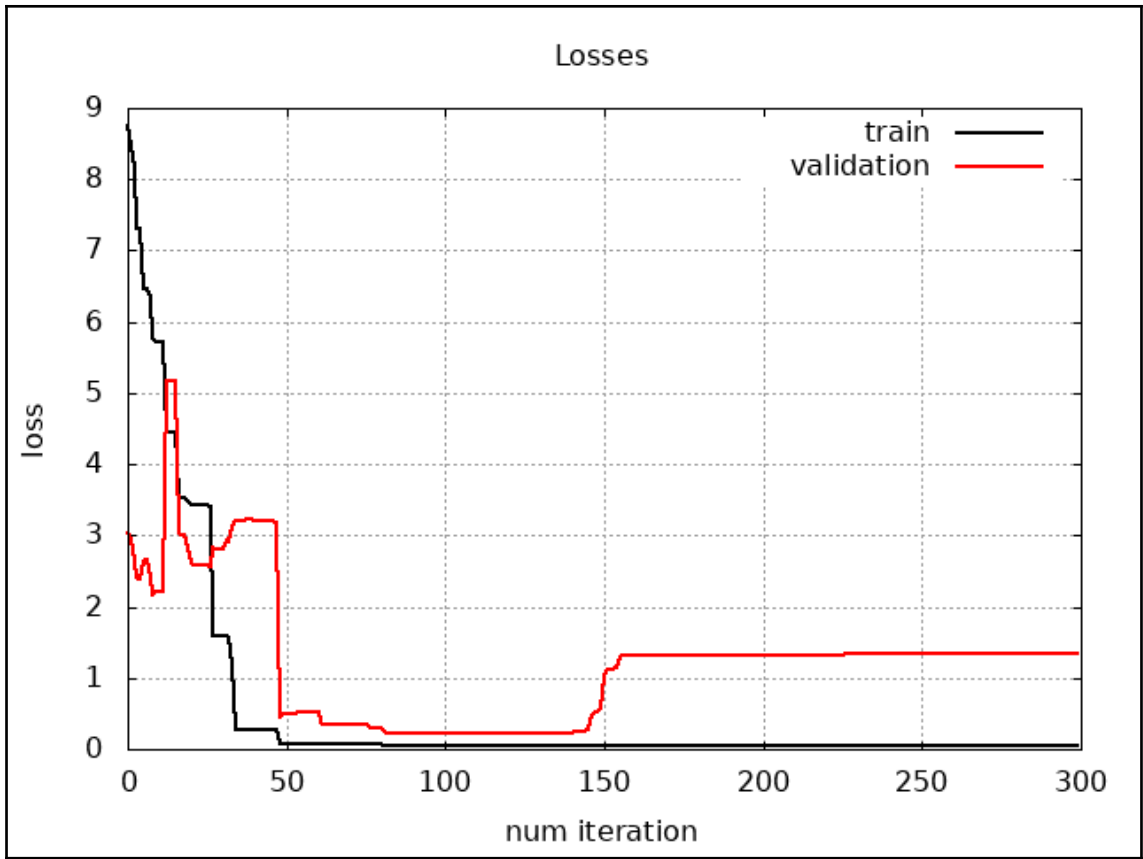

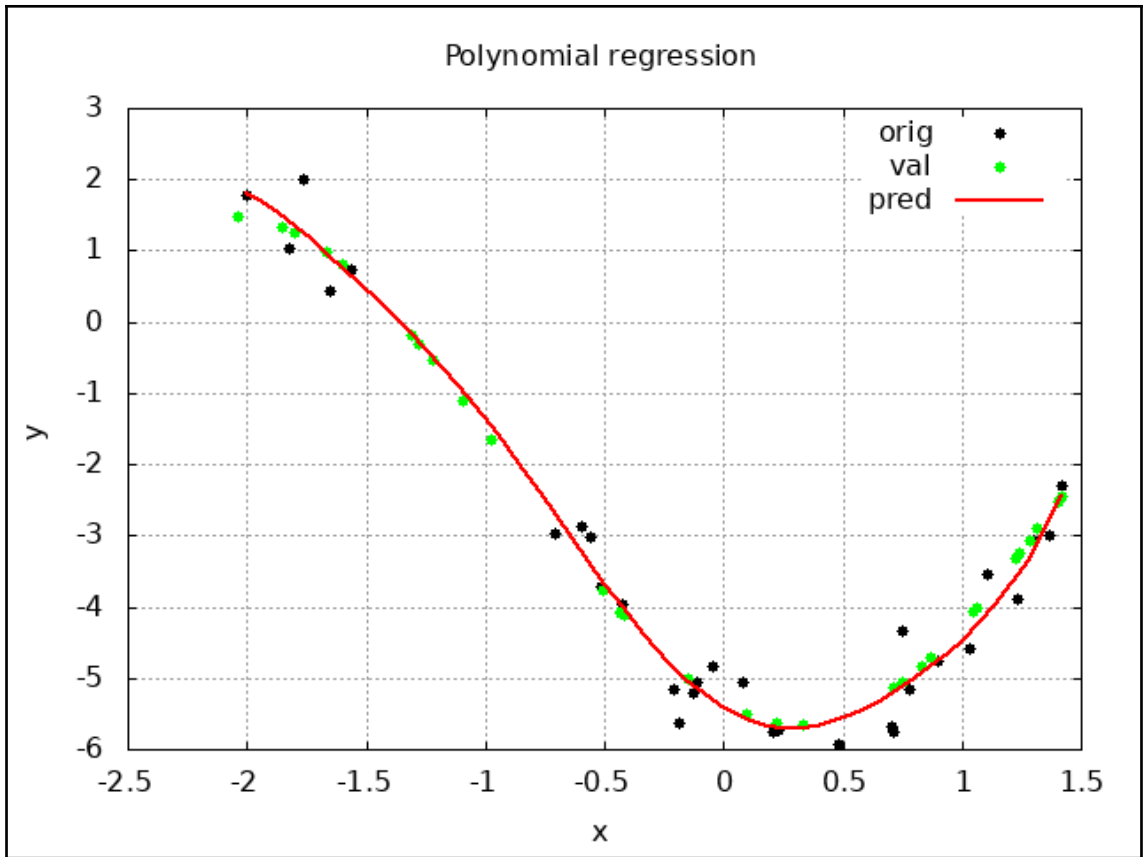

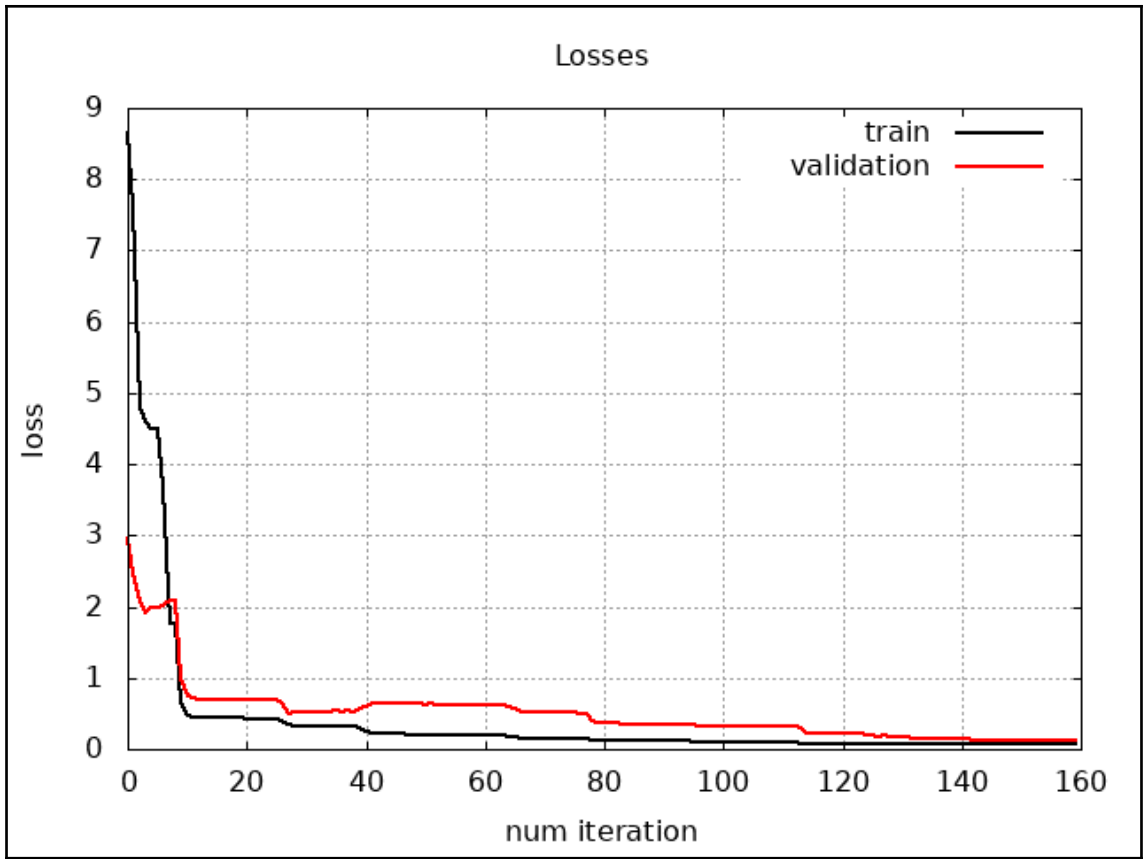

Dataset



Training

Validation

Validation

Validation

Chapter 4: Clustering

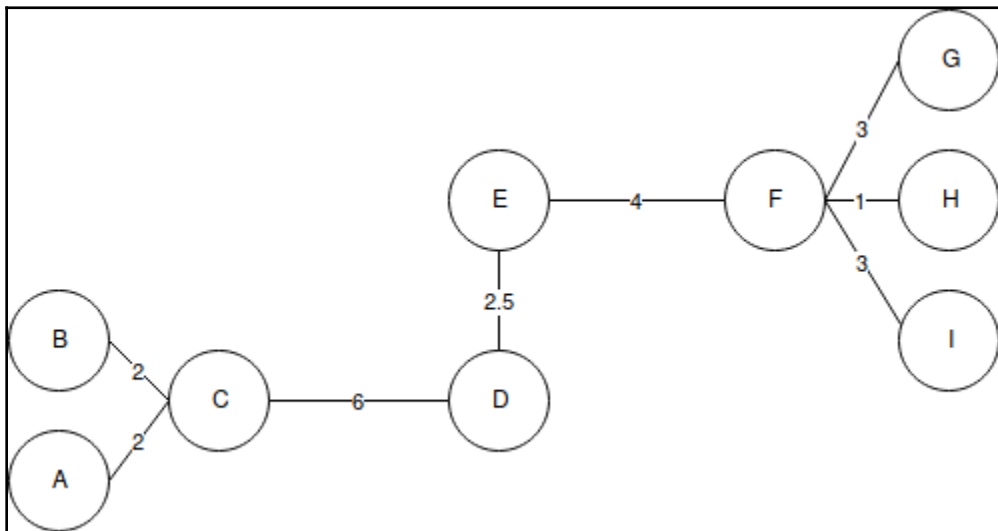
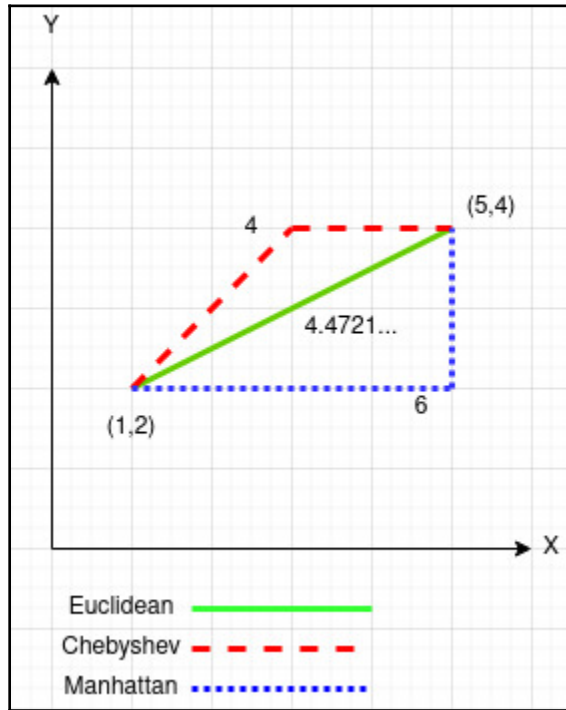

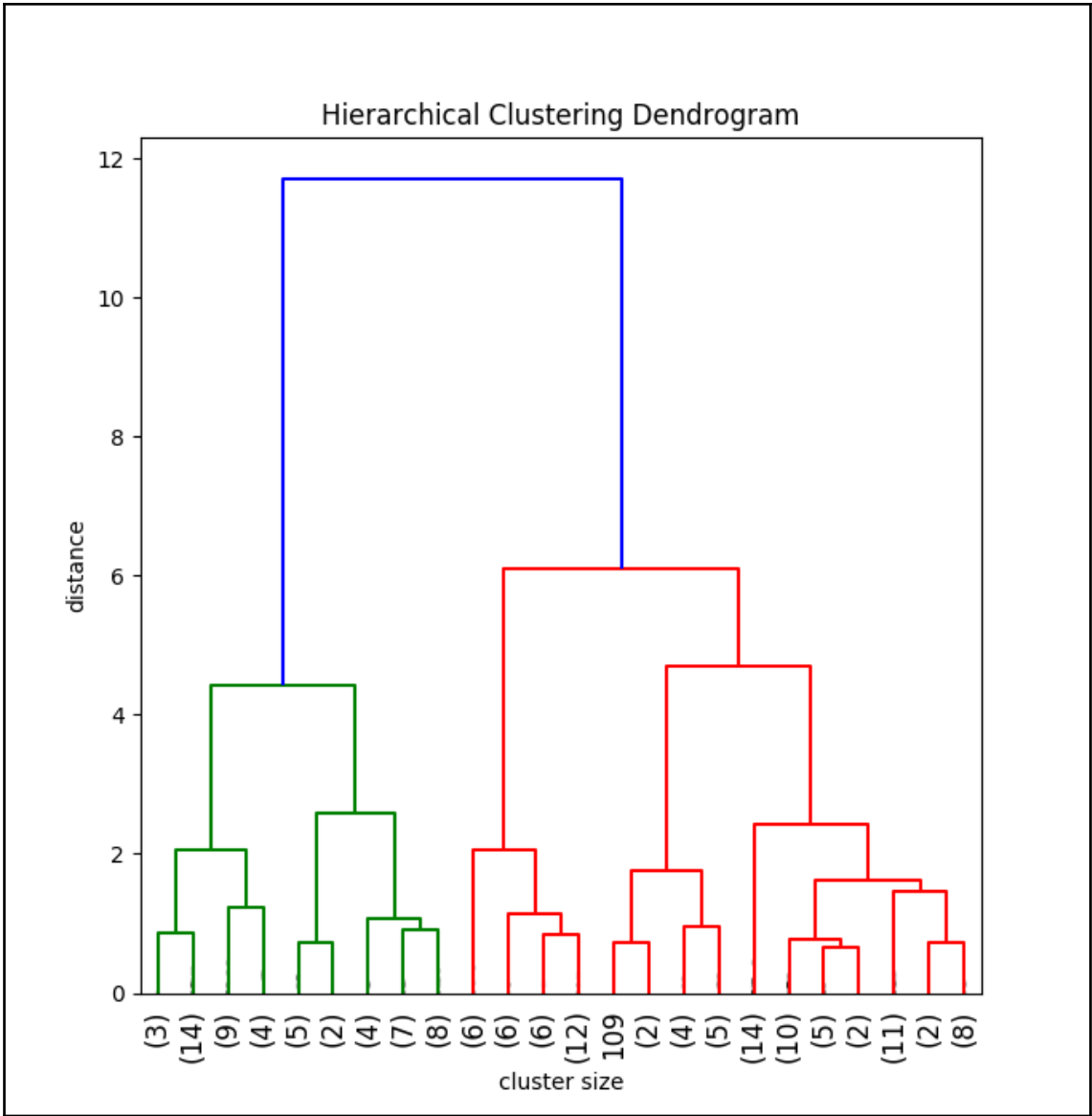

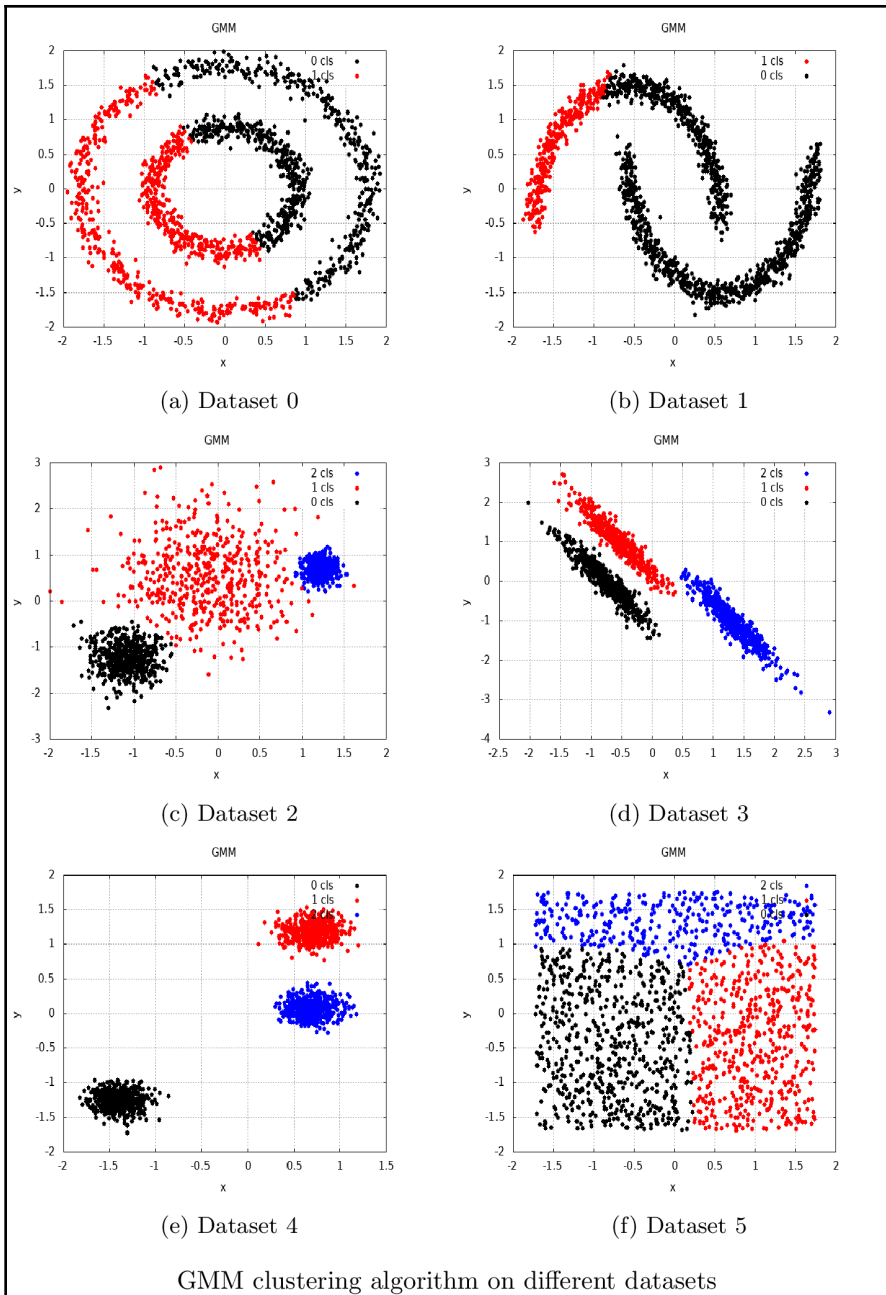

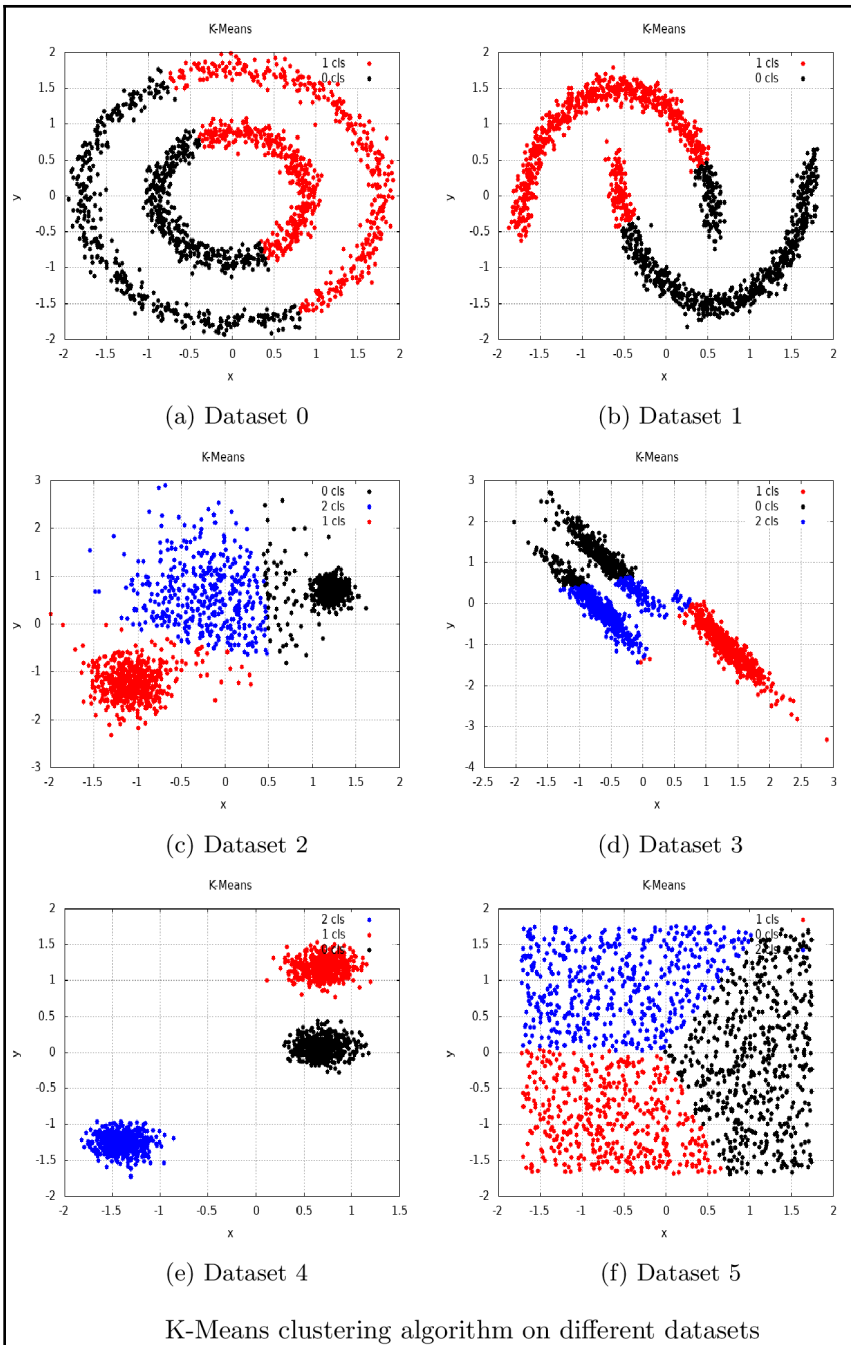

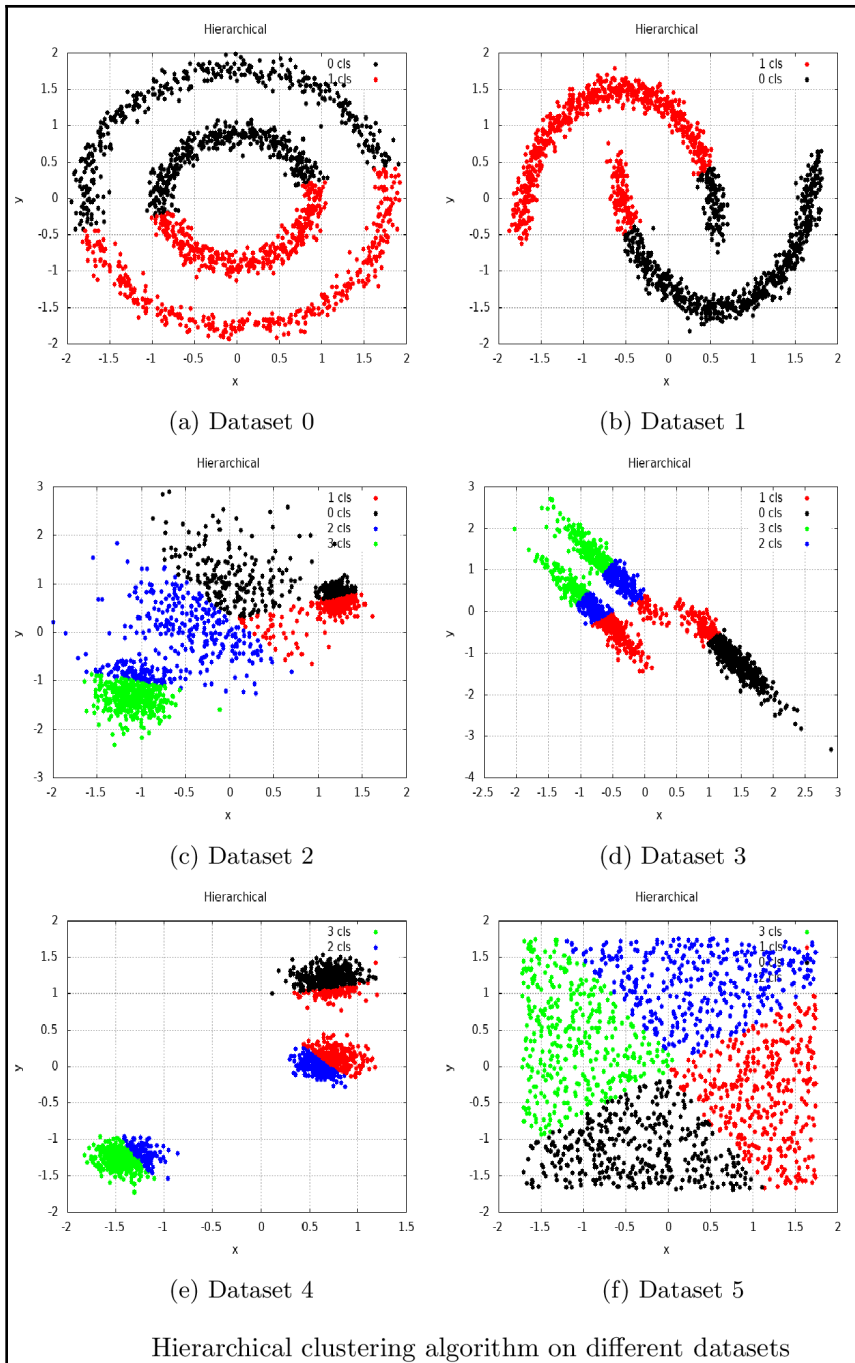

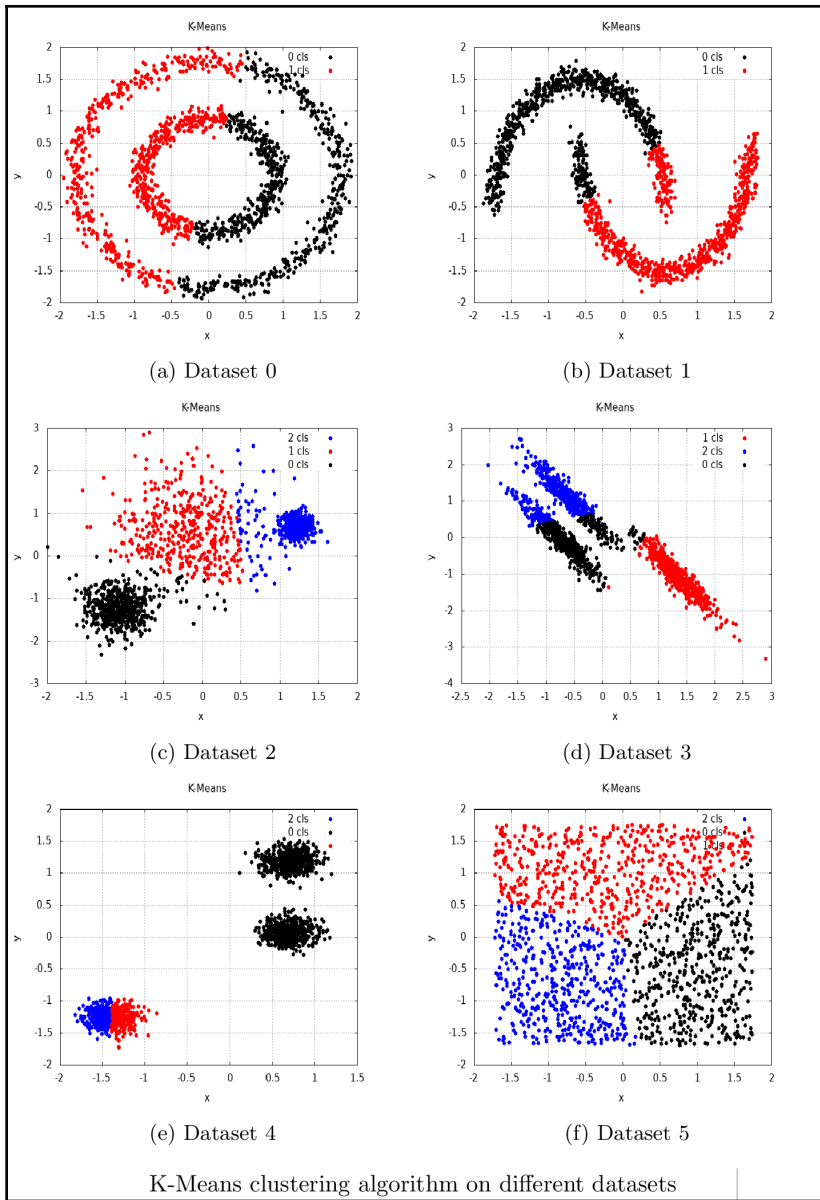

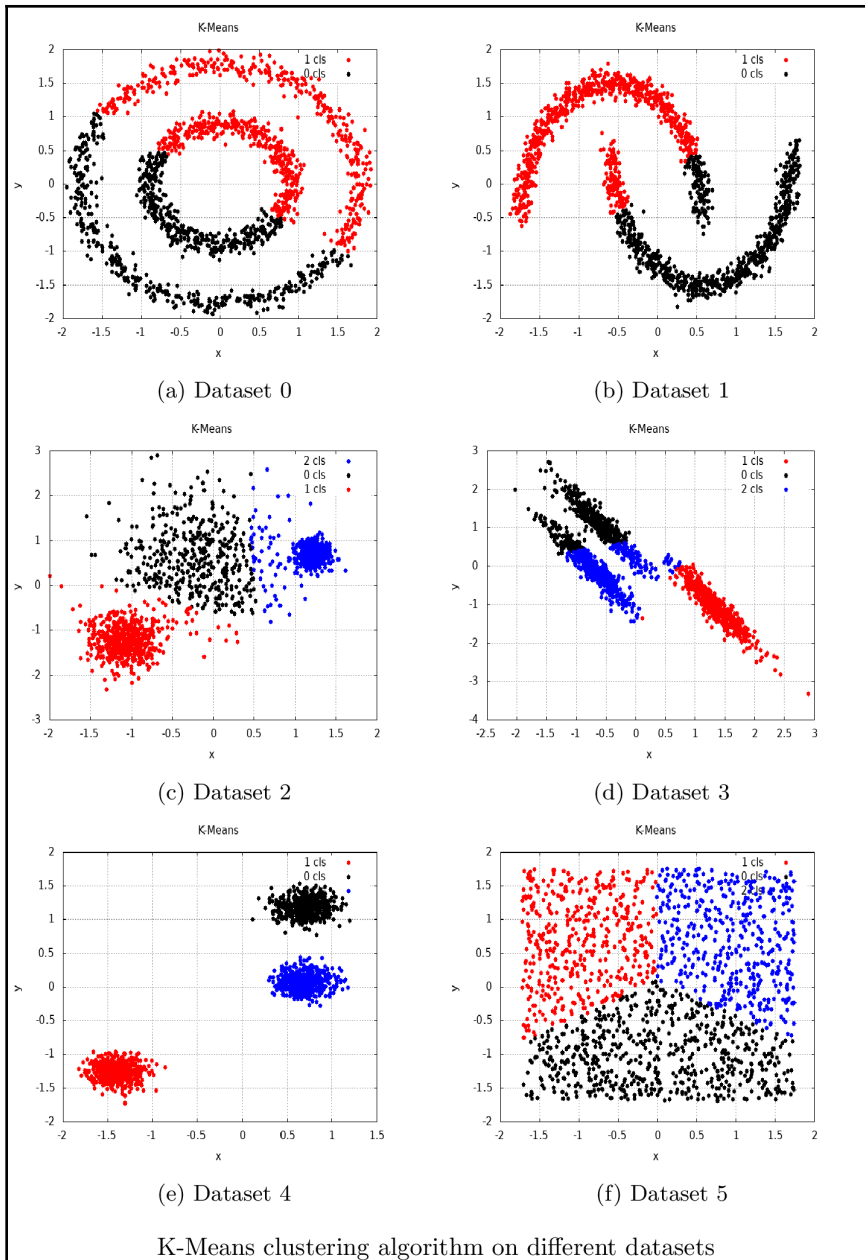

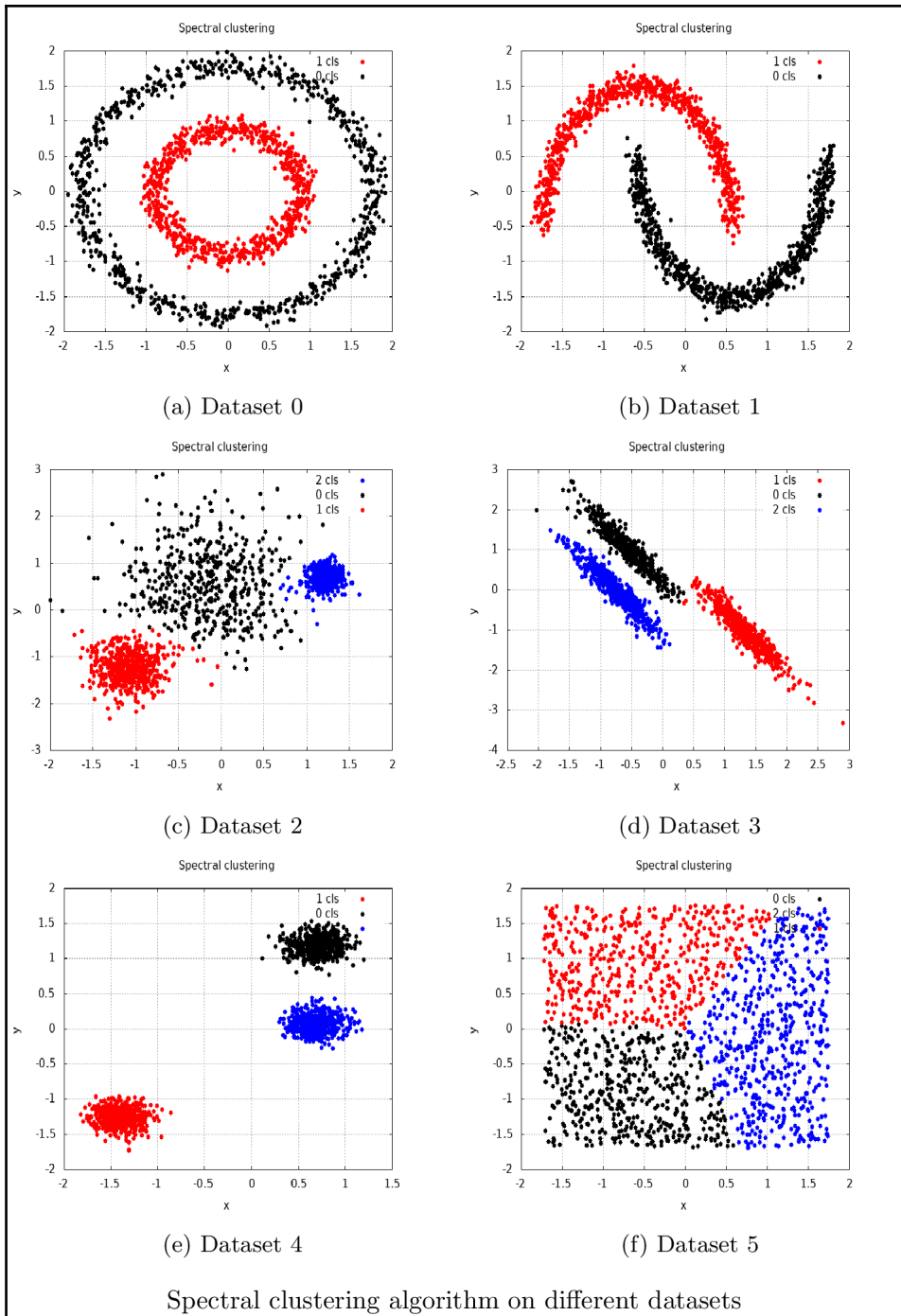

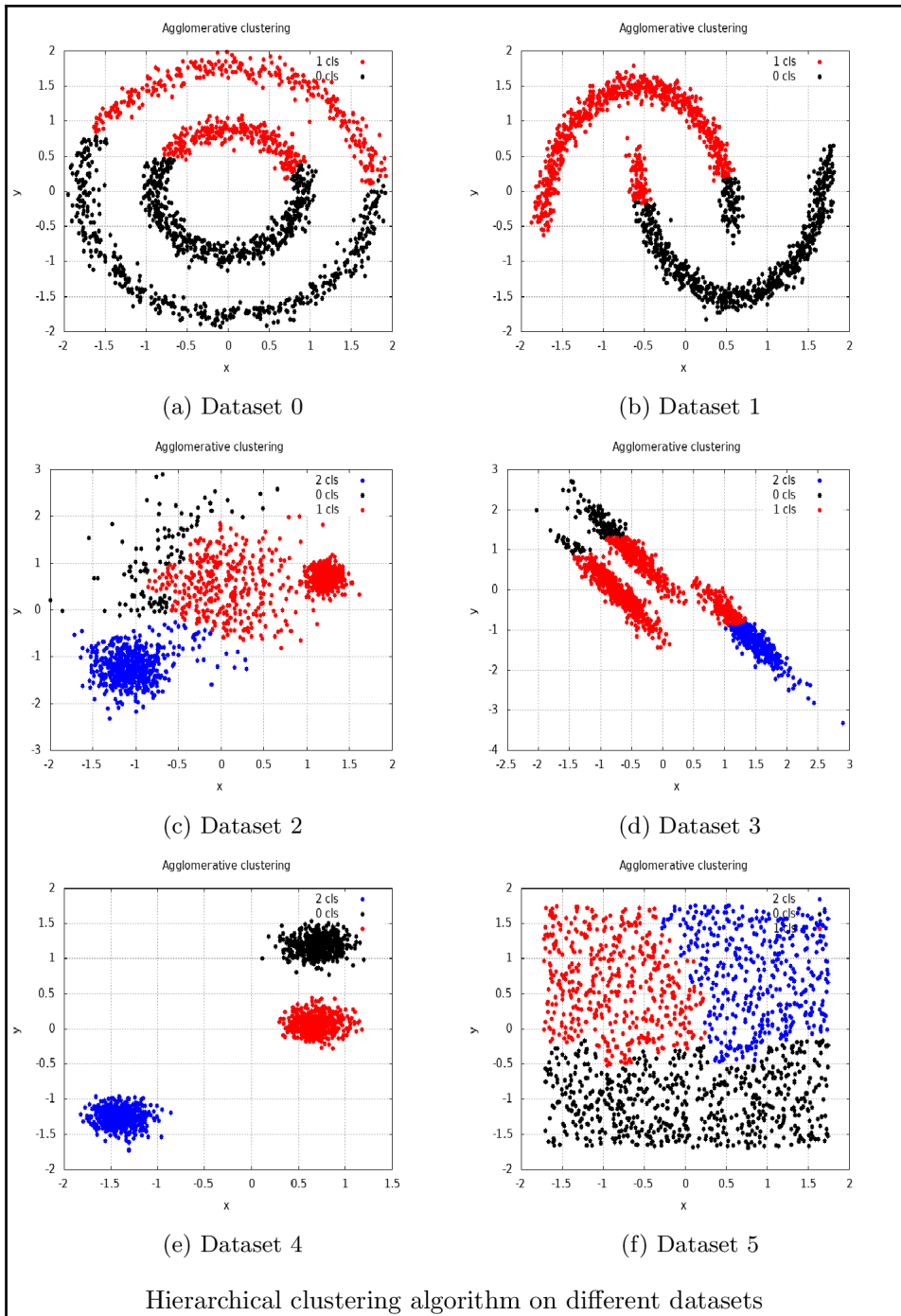

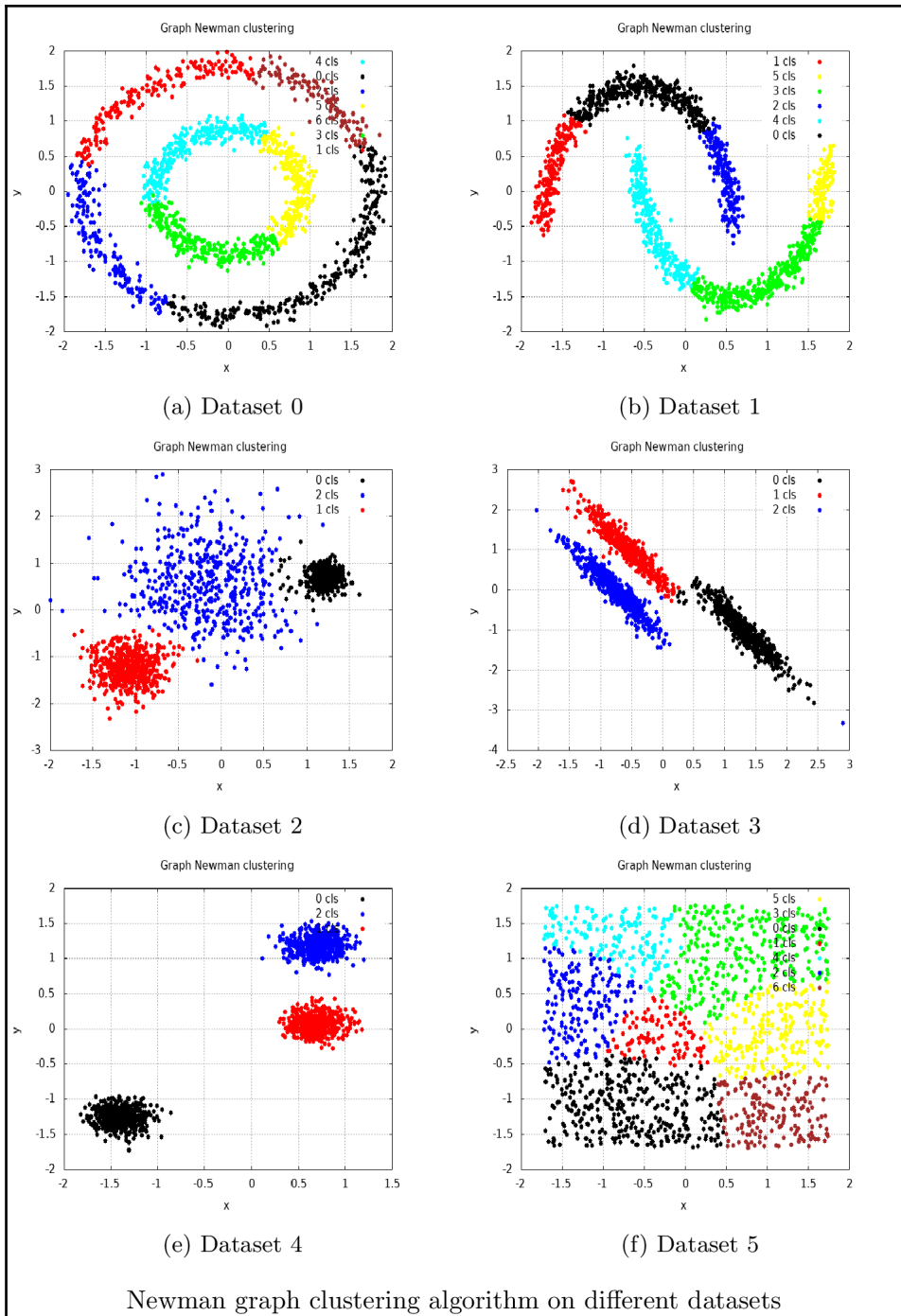

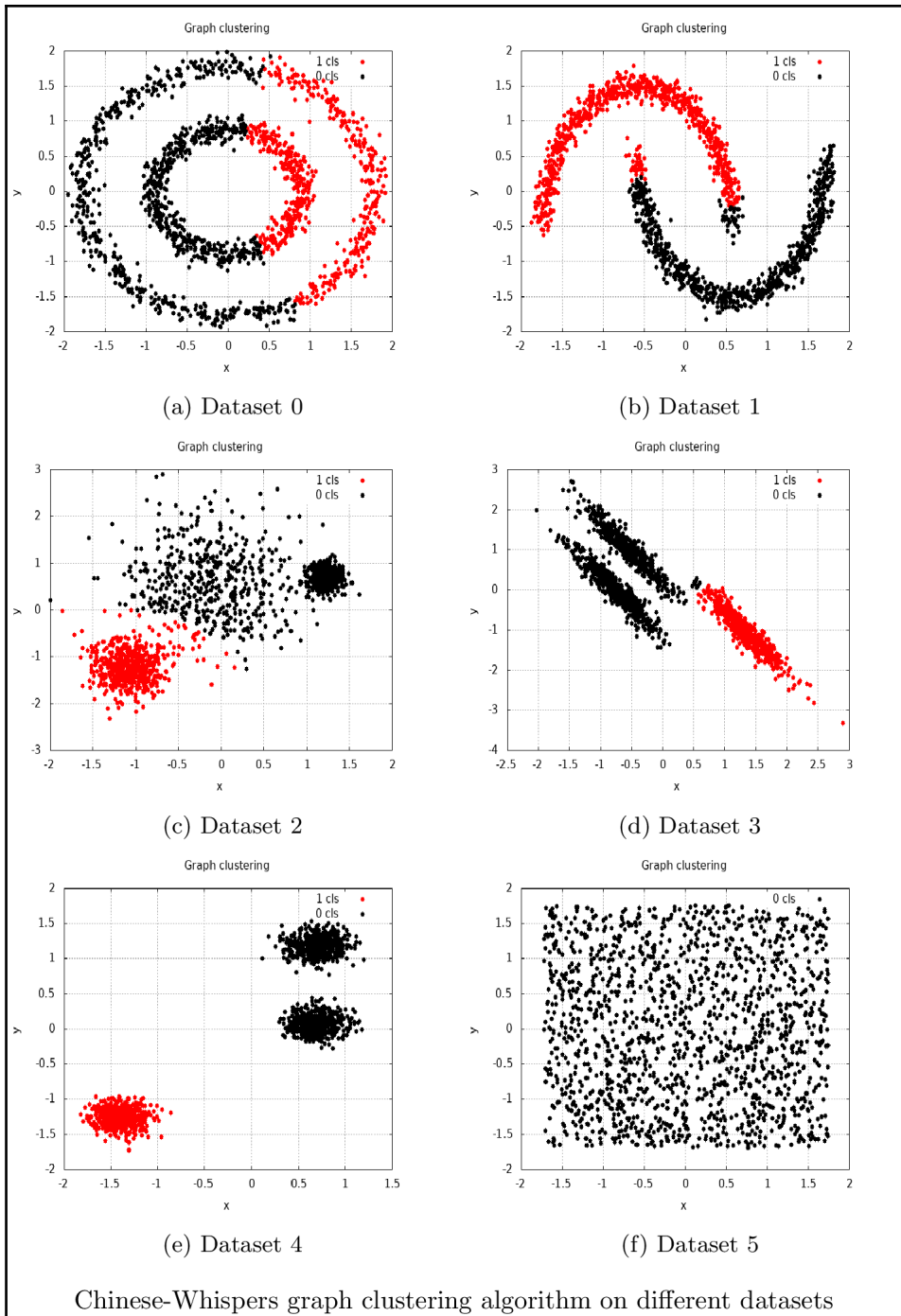

Chapter 5: Anomaly Detection

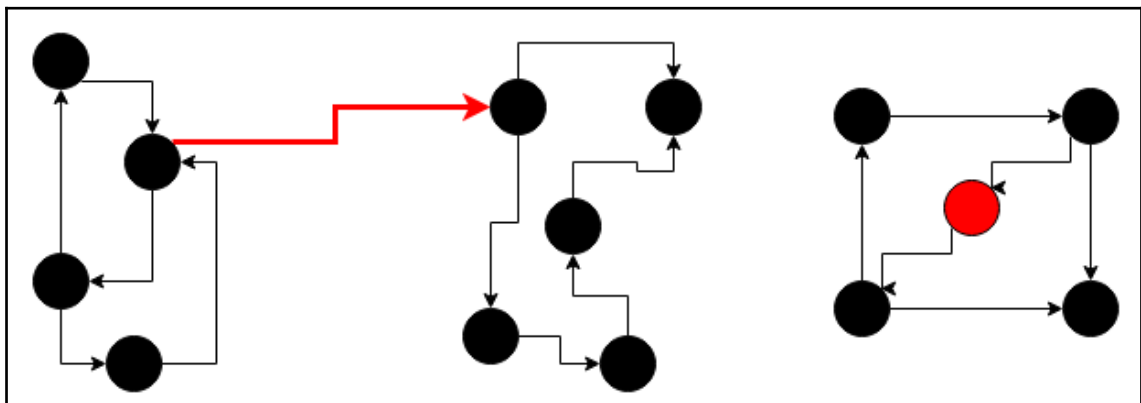
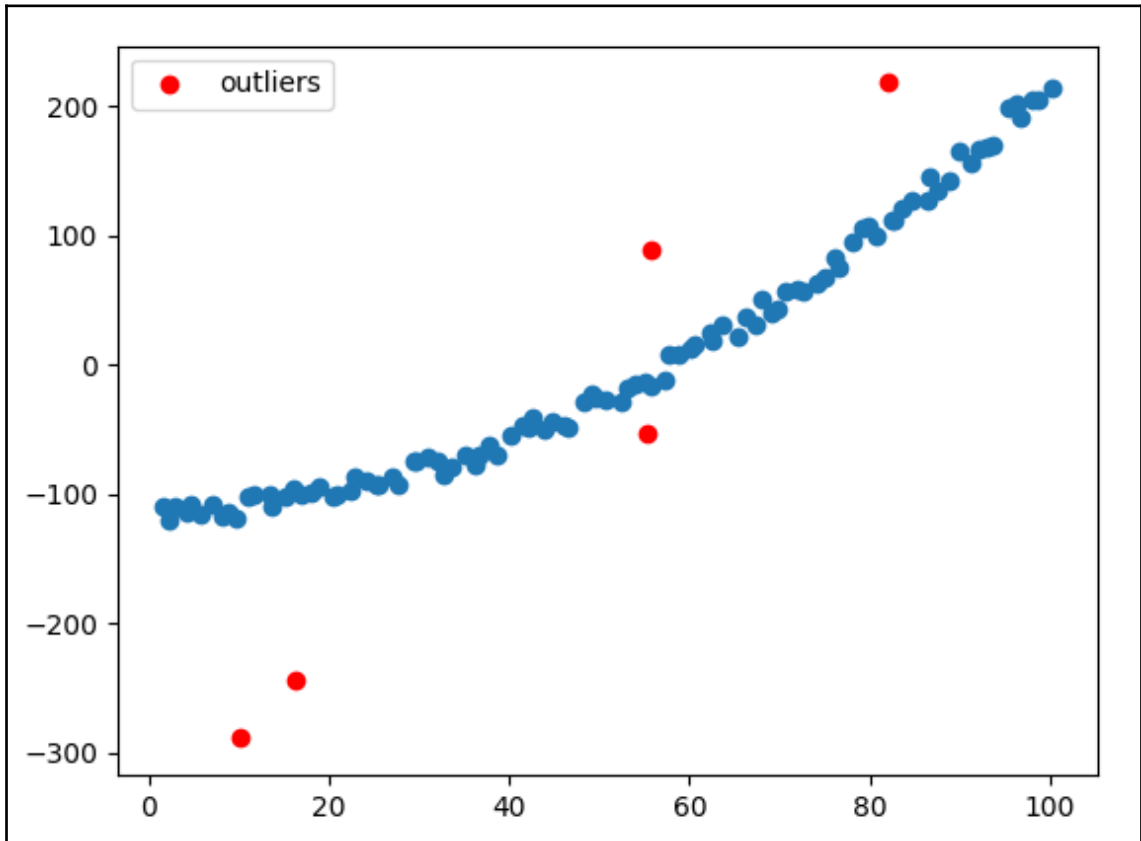

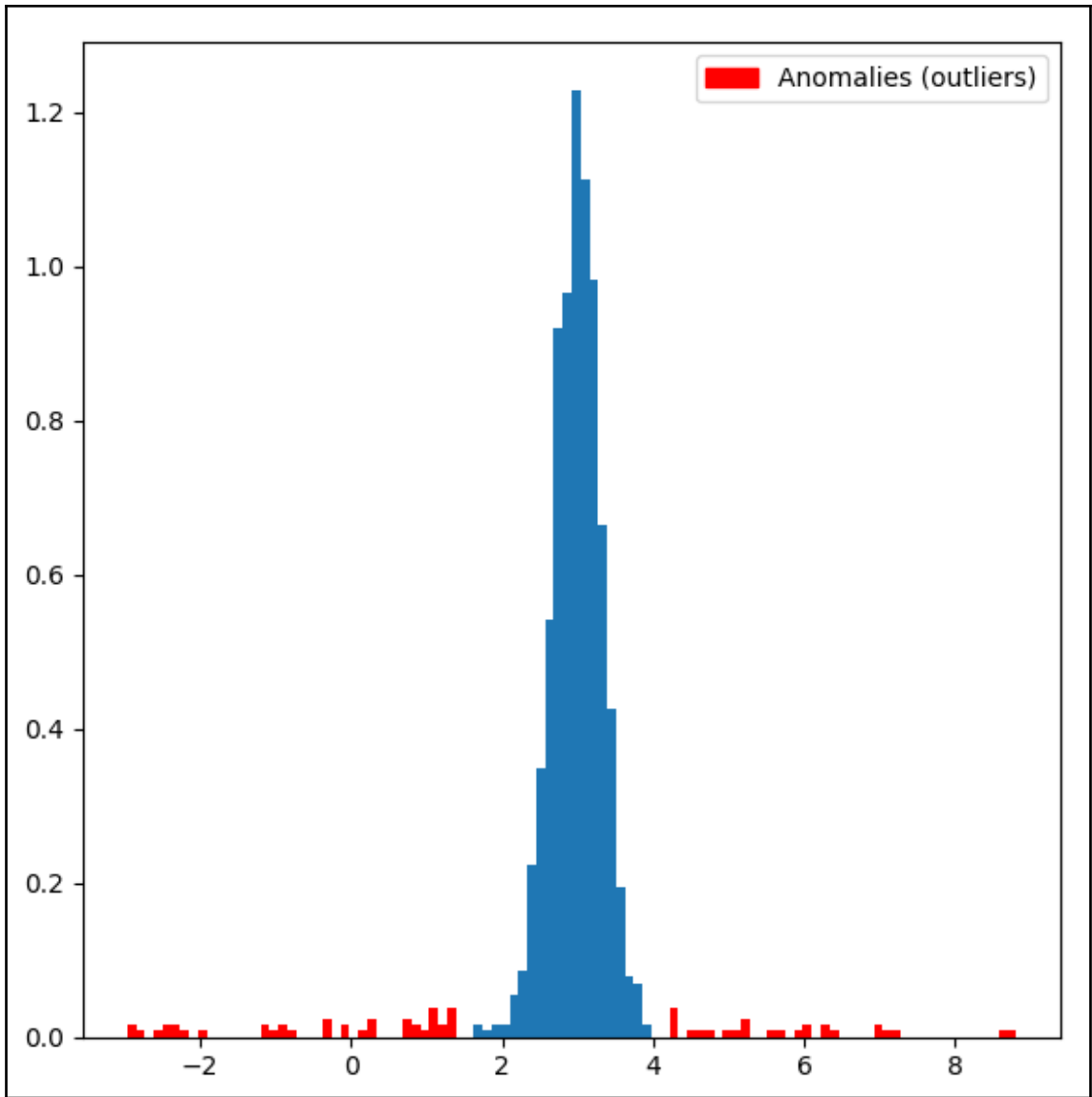

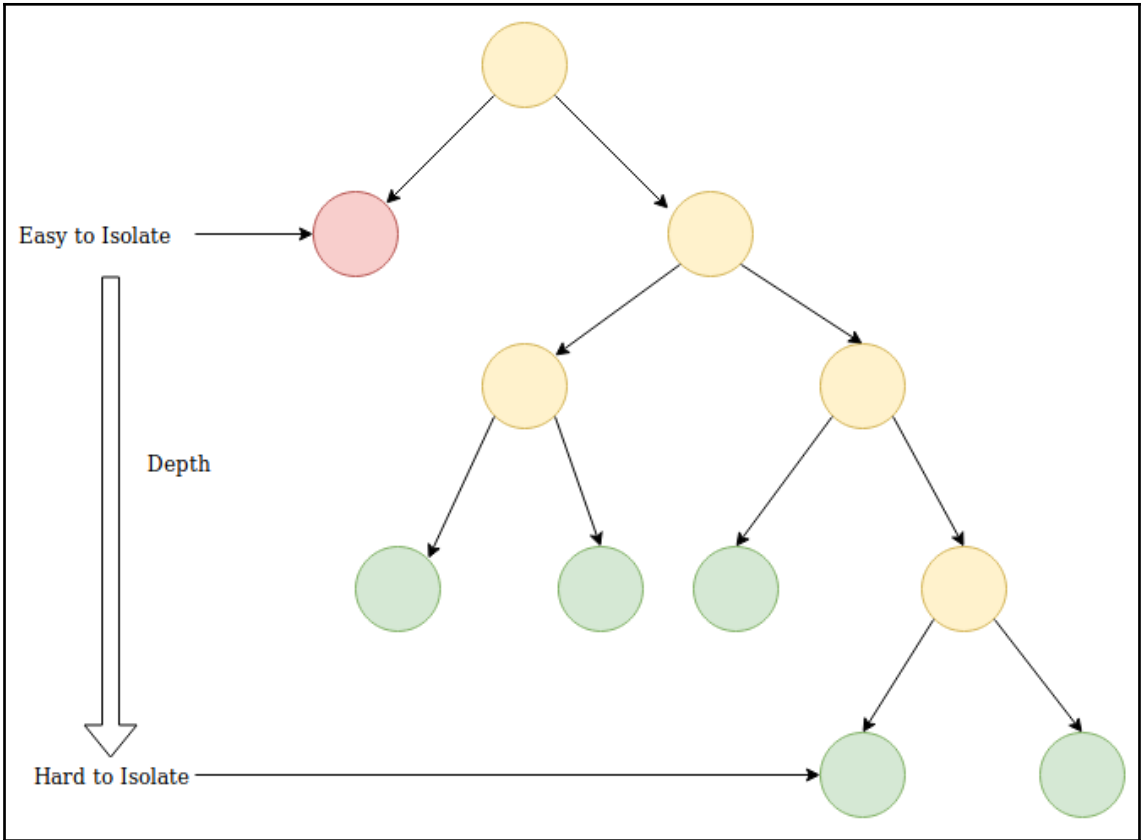

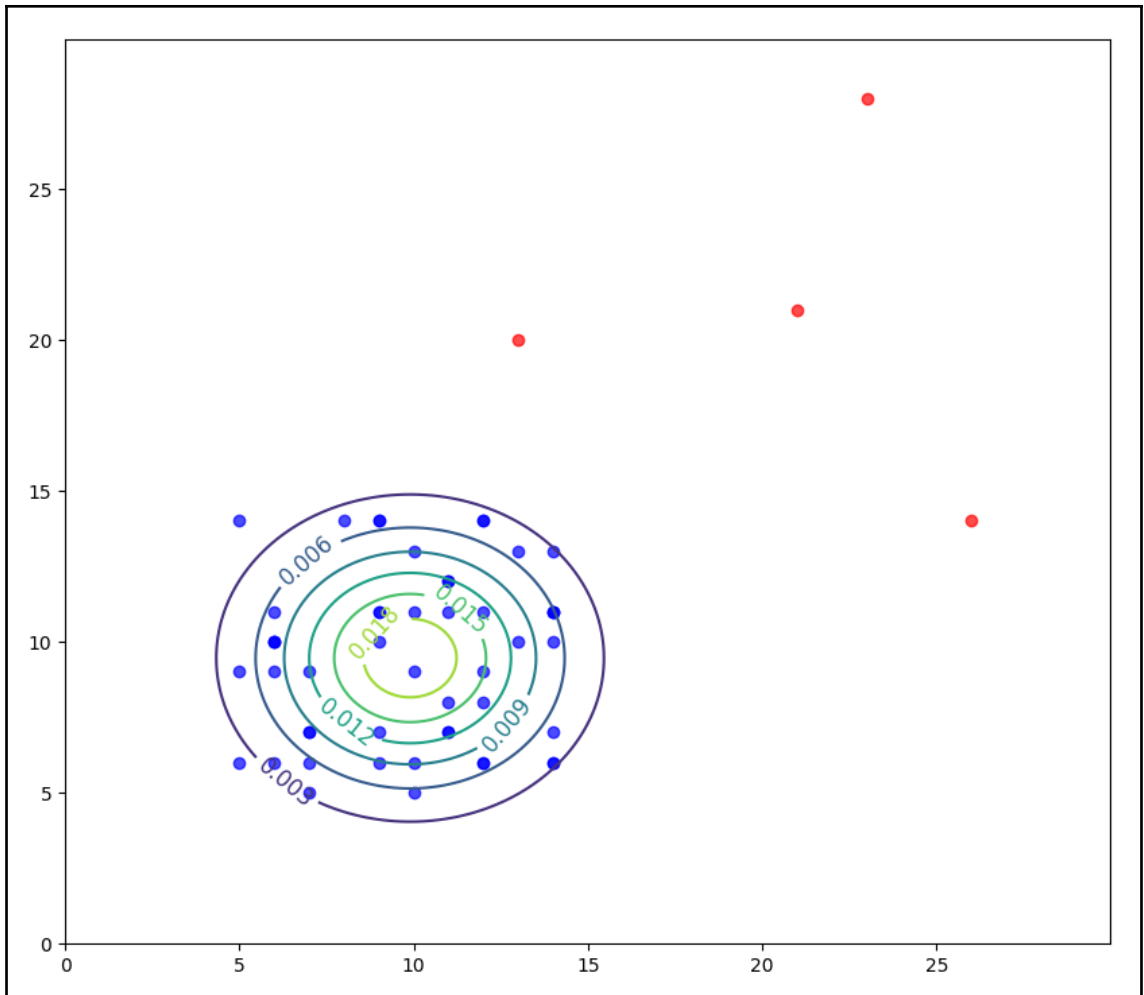

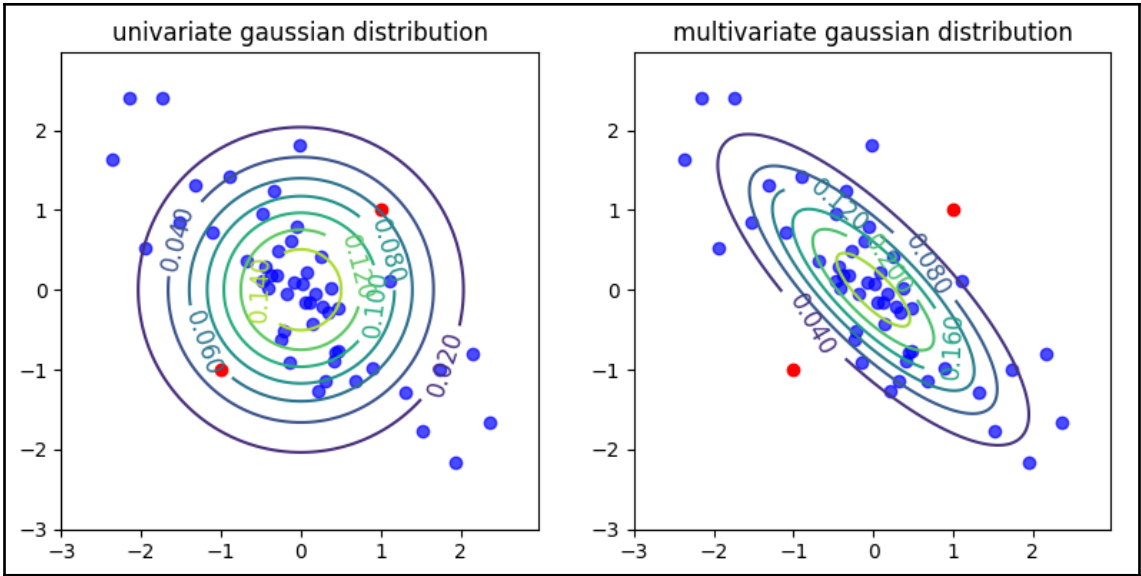

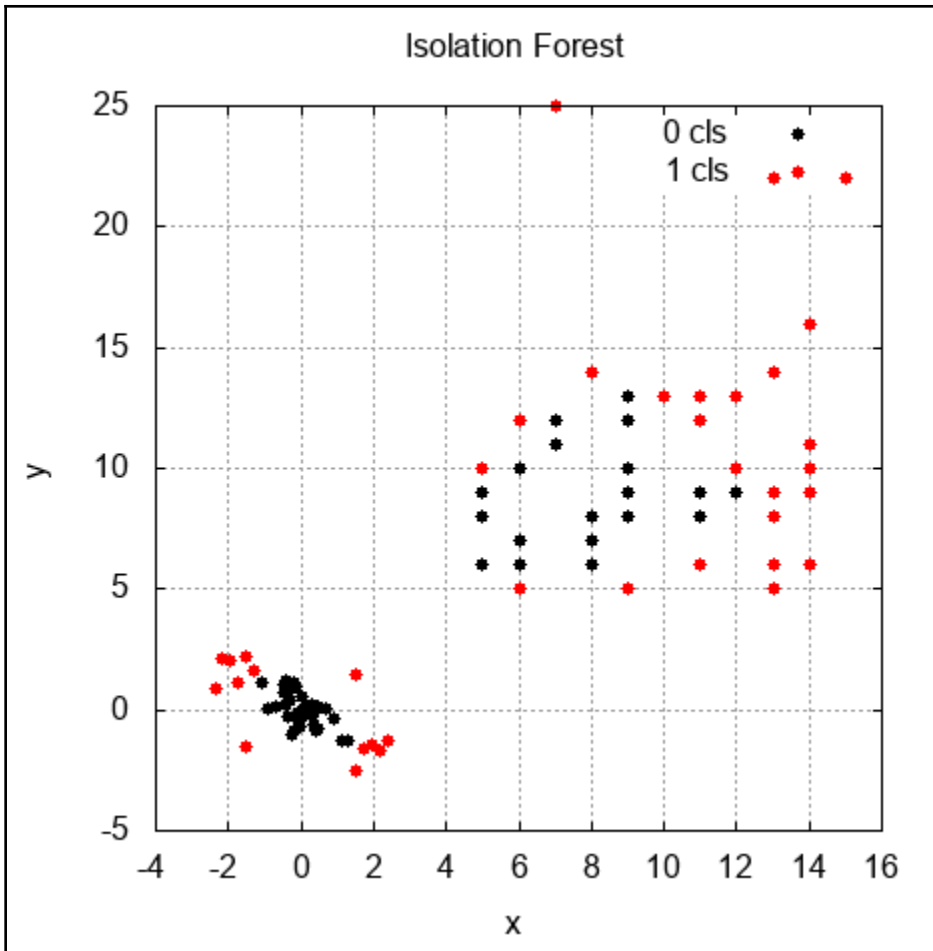

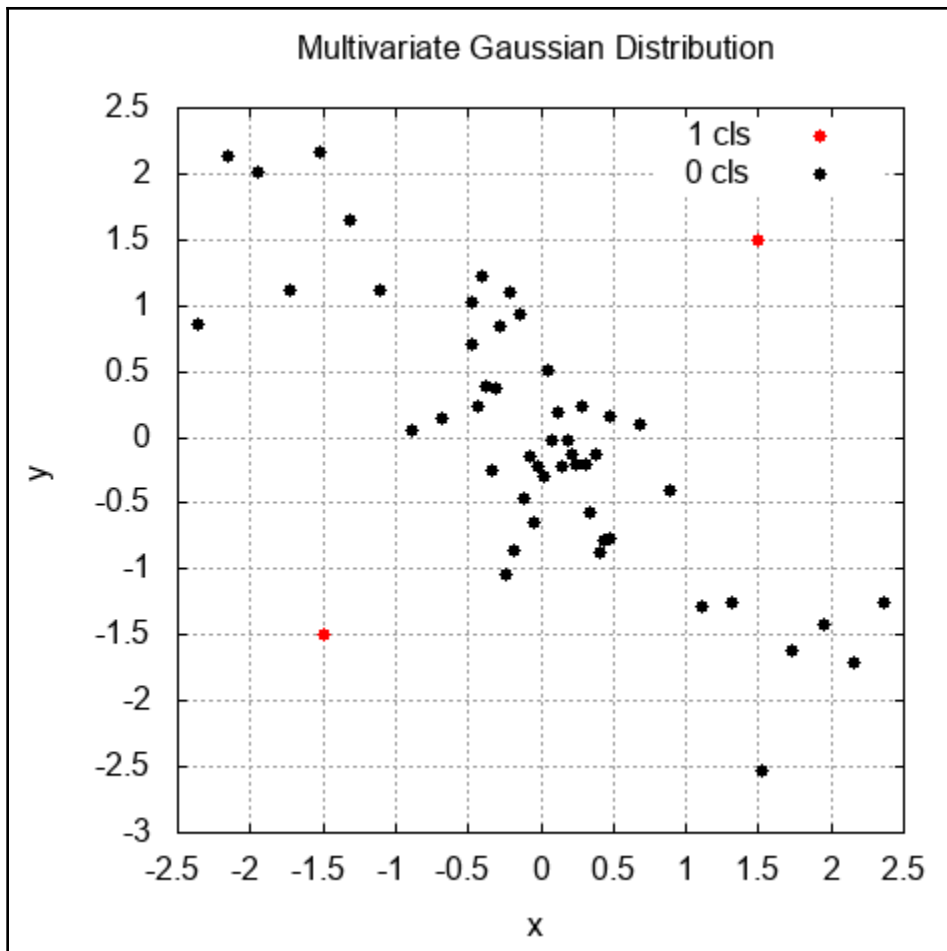

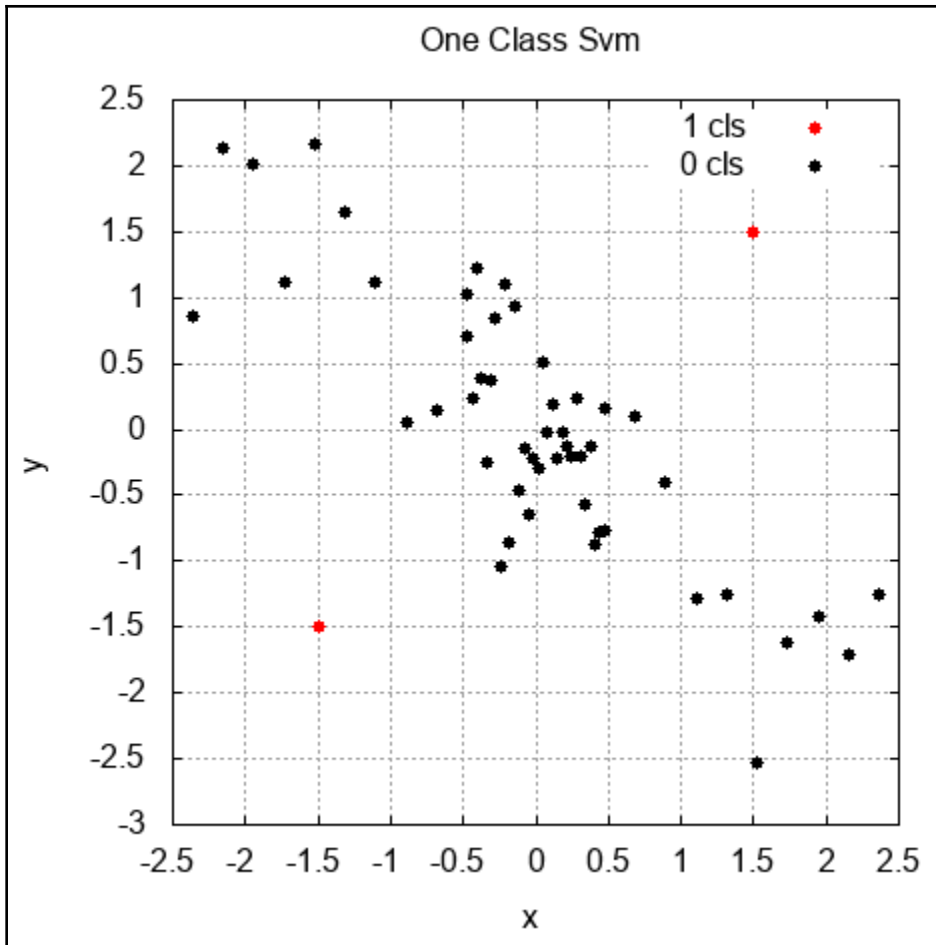

Chapter 6: Dimensionality Reduction

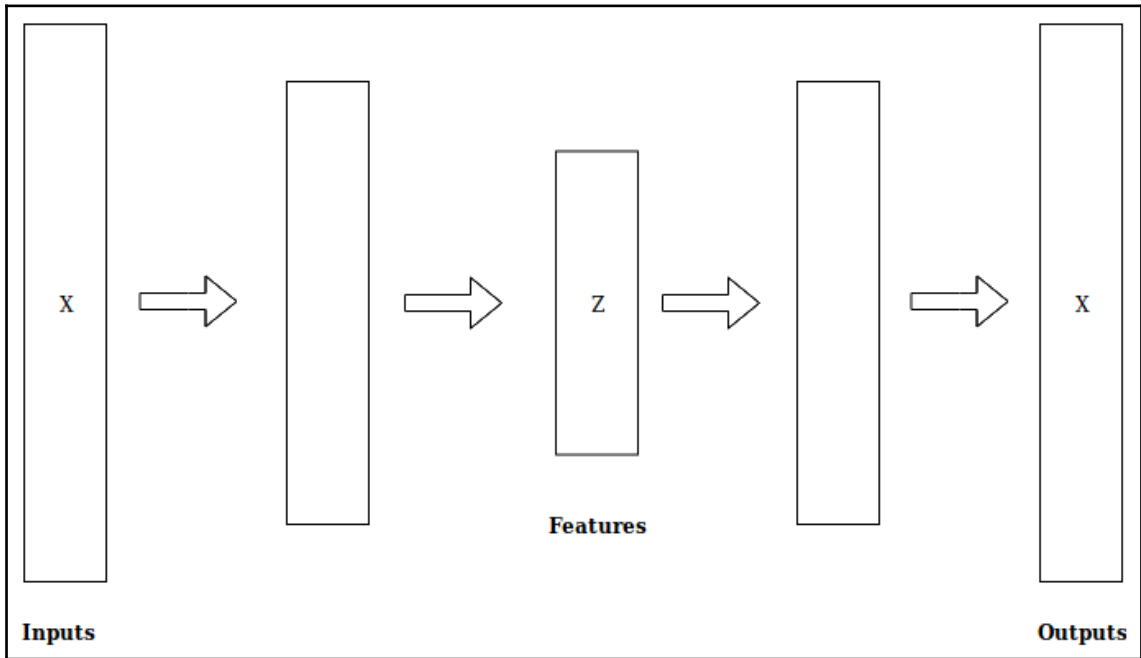

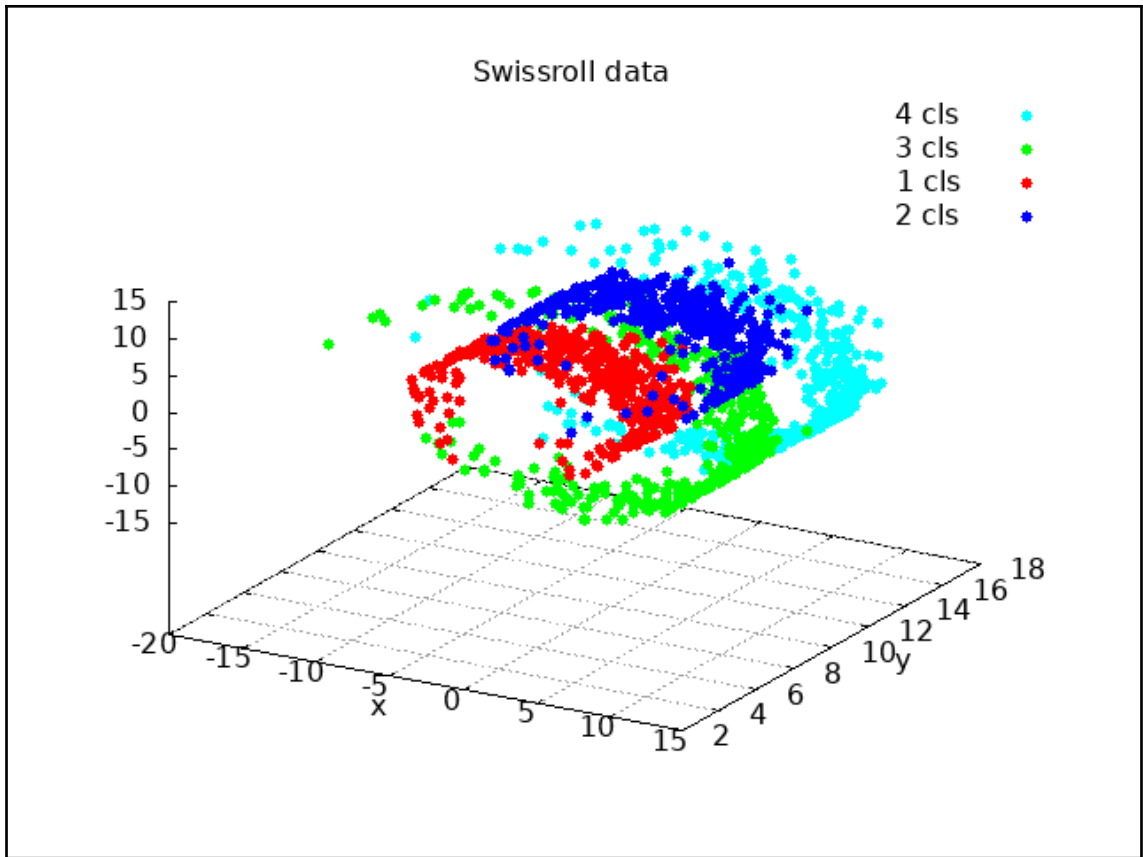

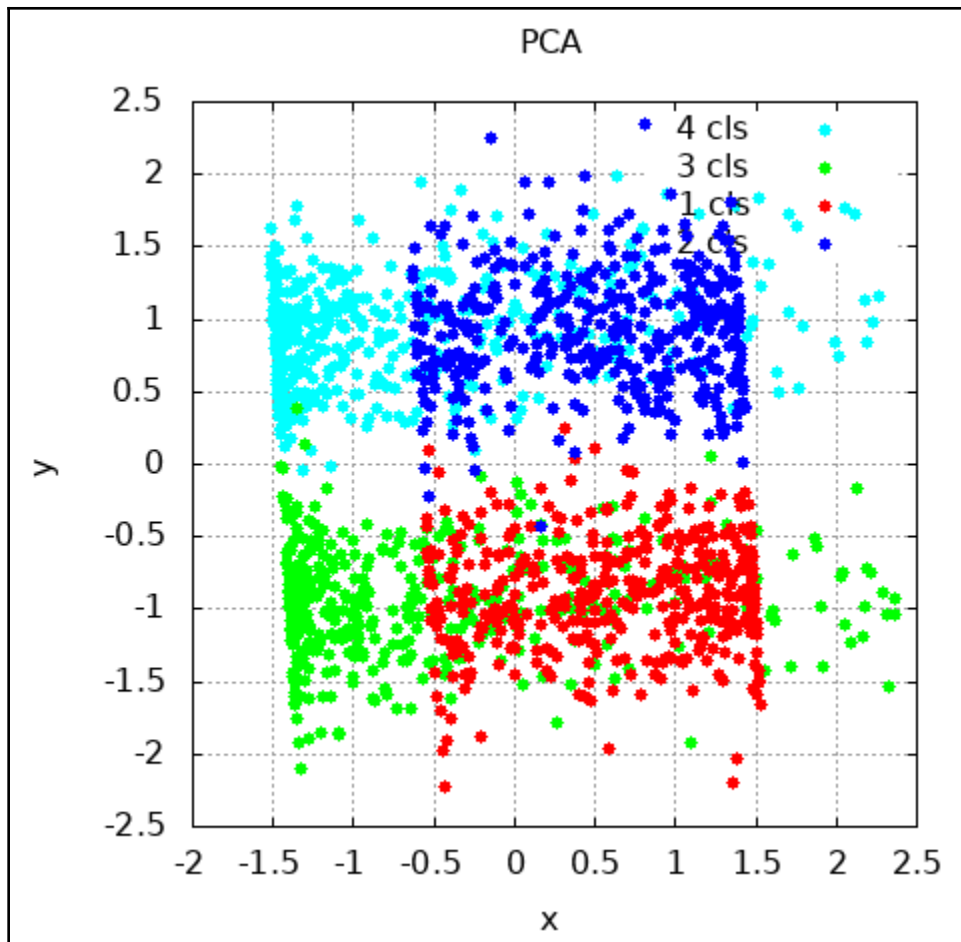





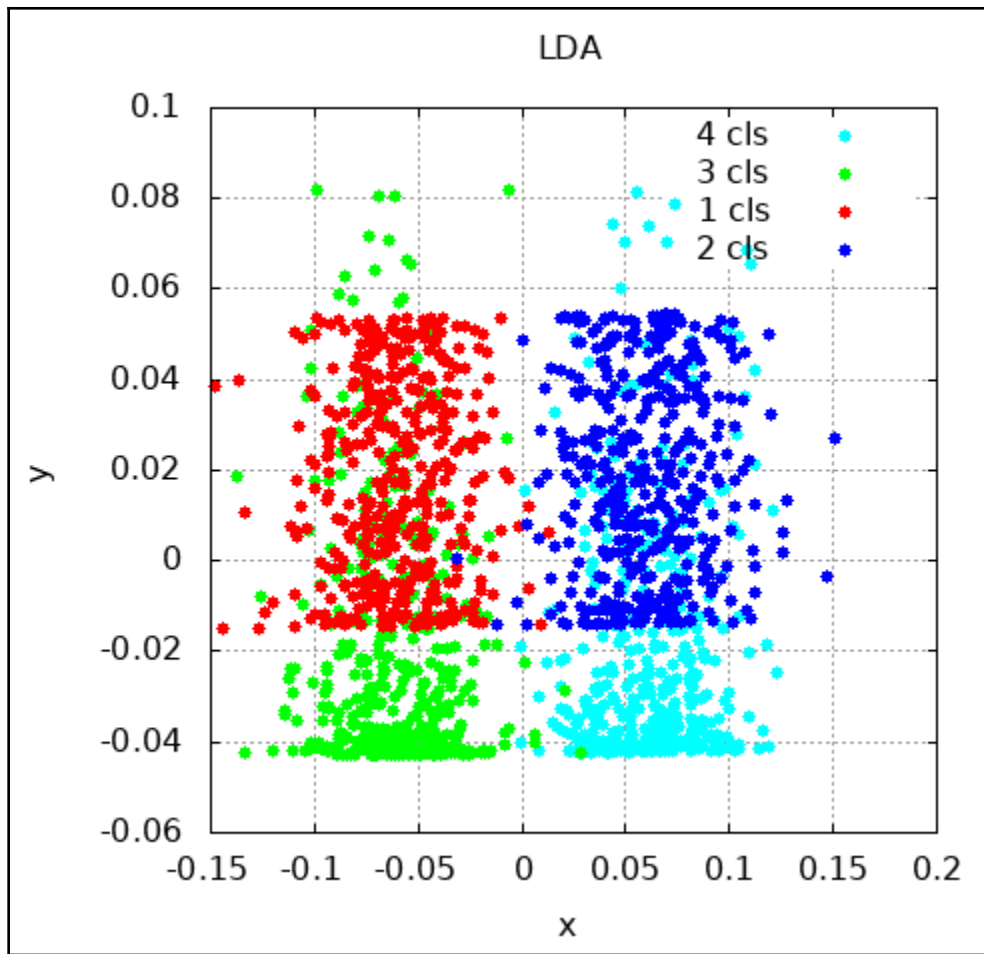

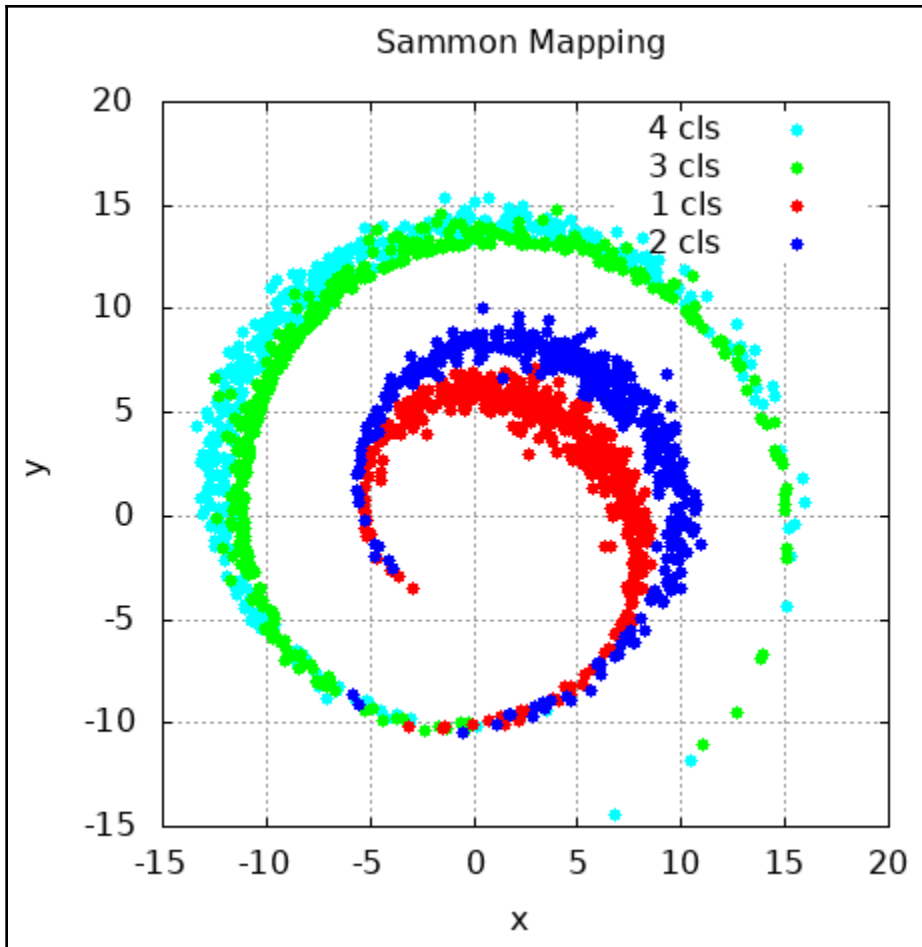

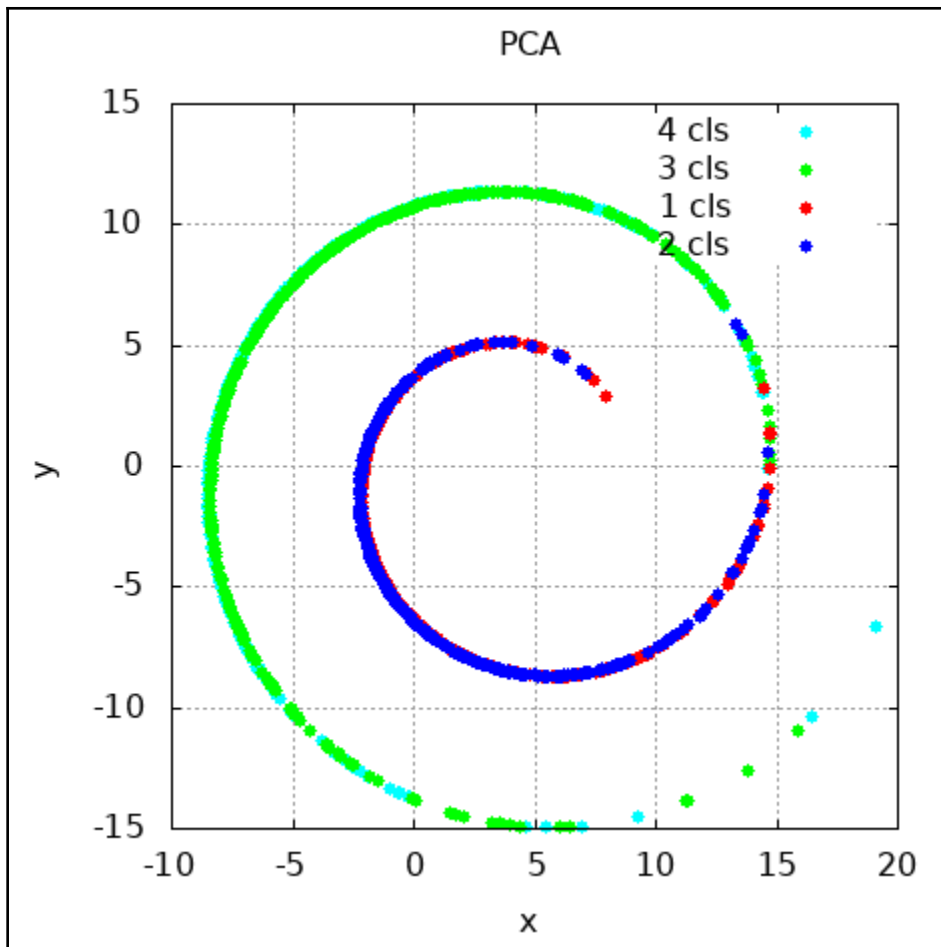

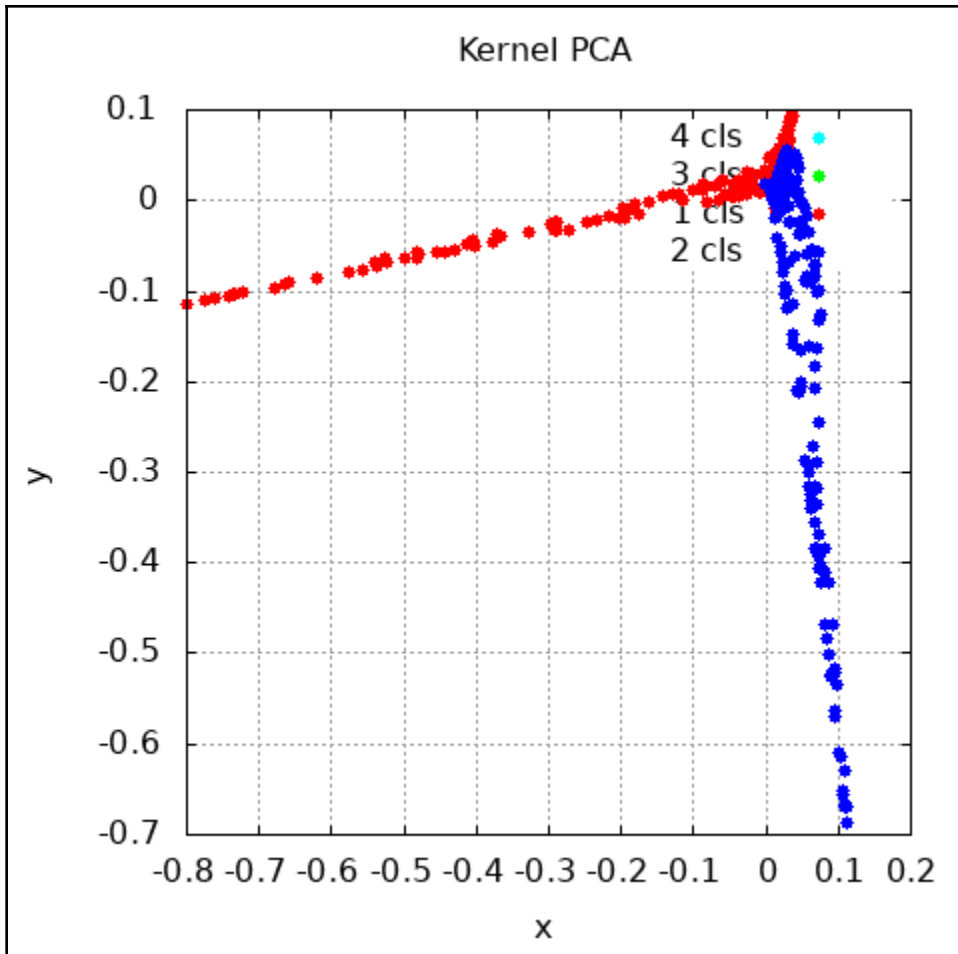

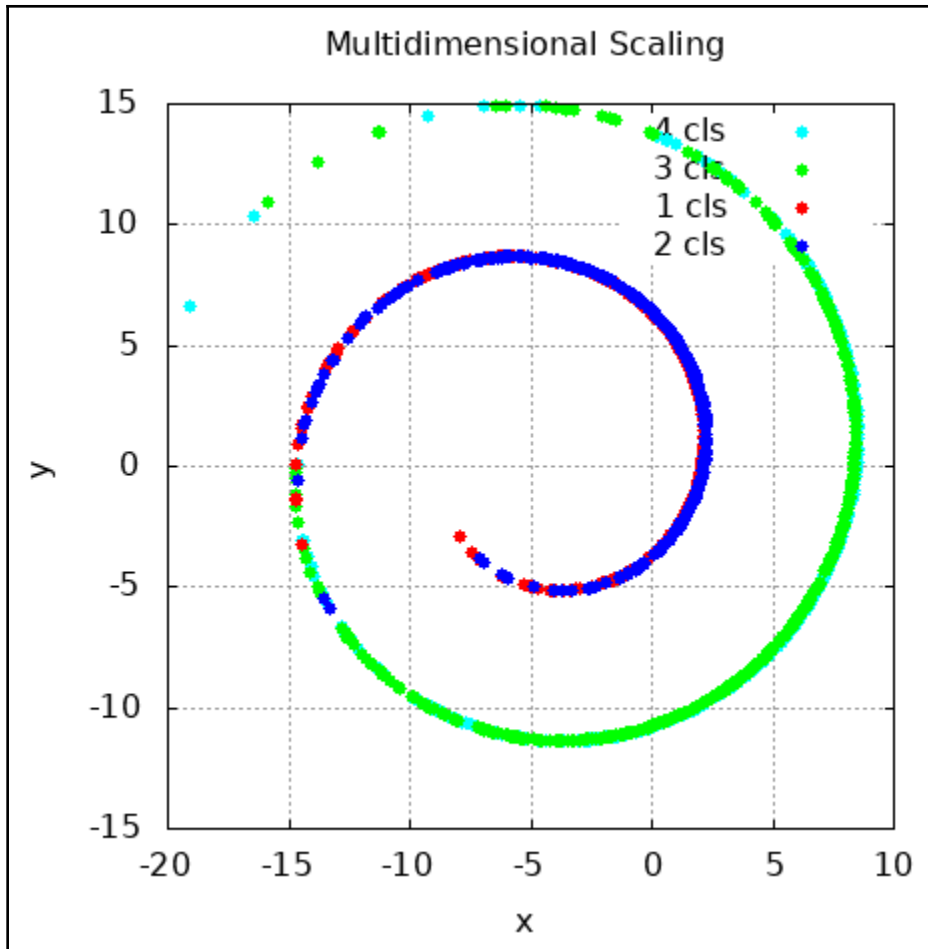

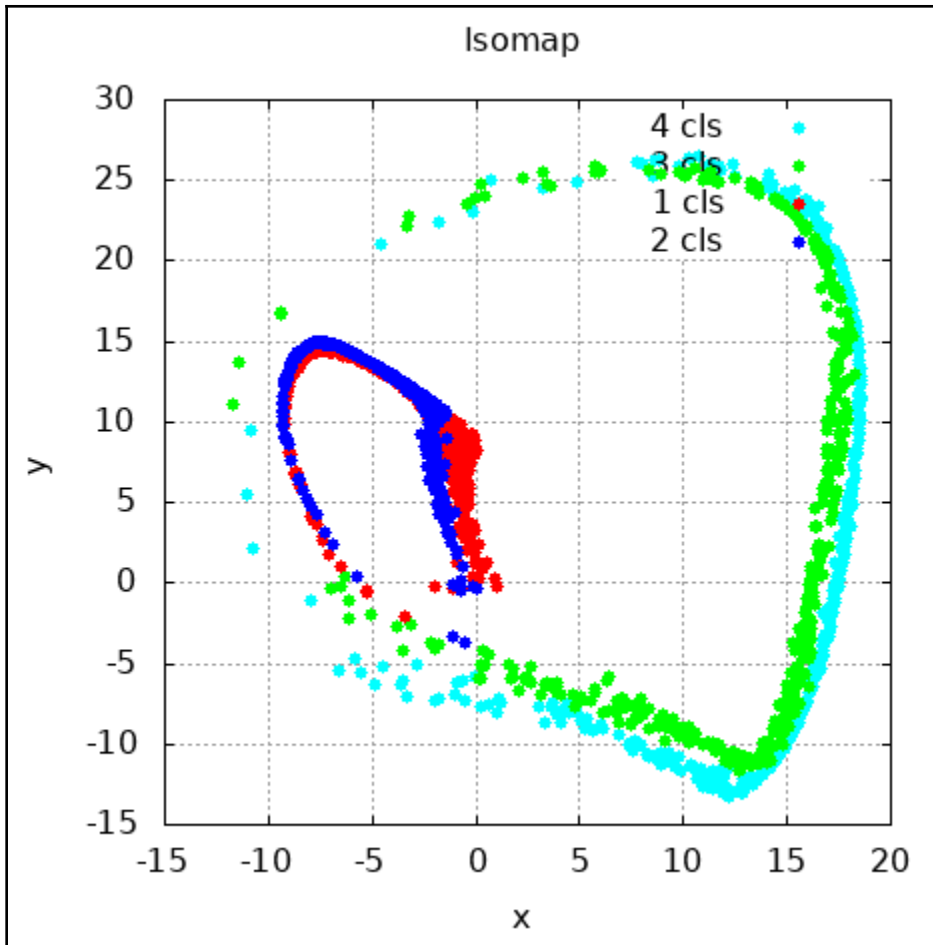

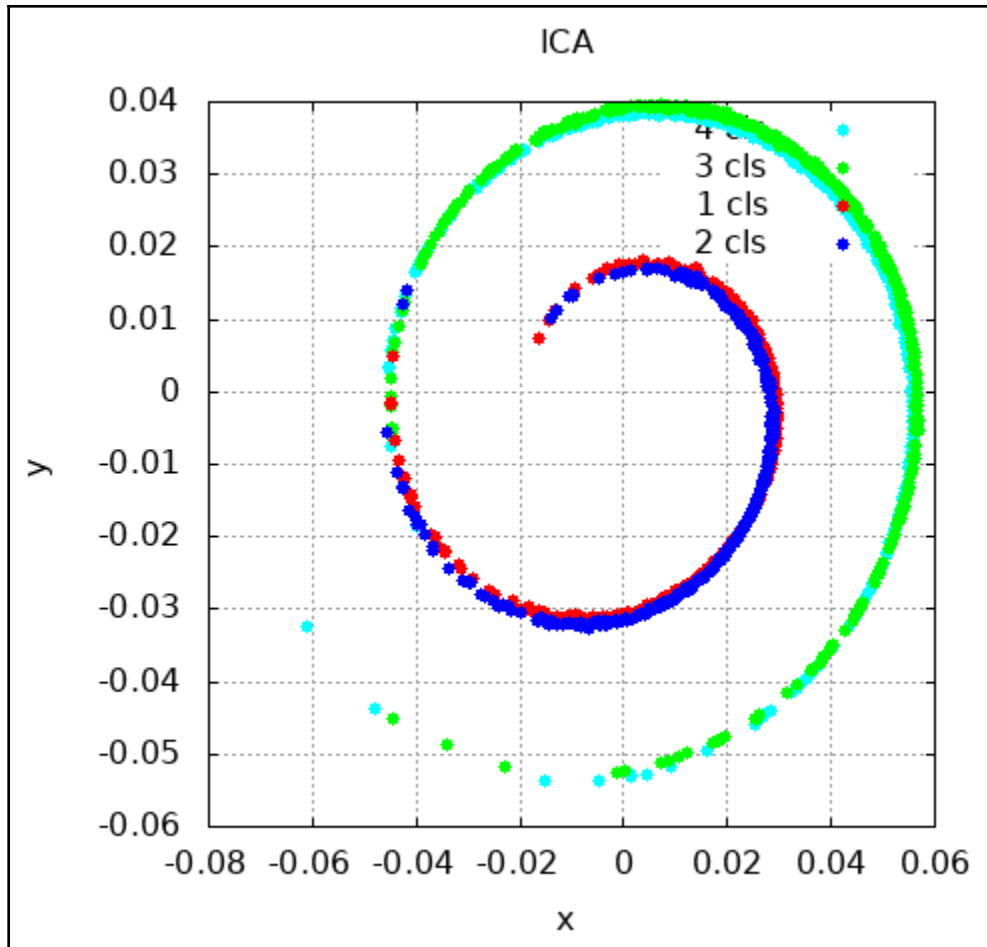

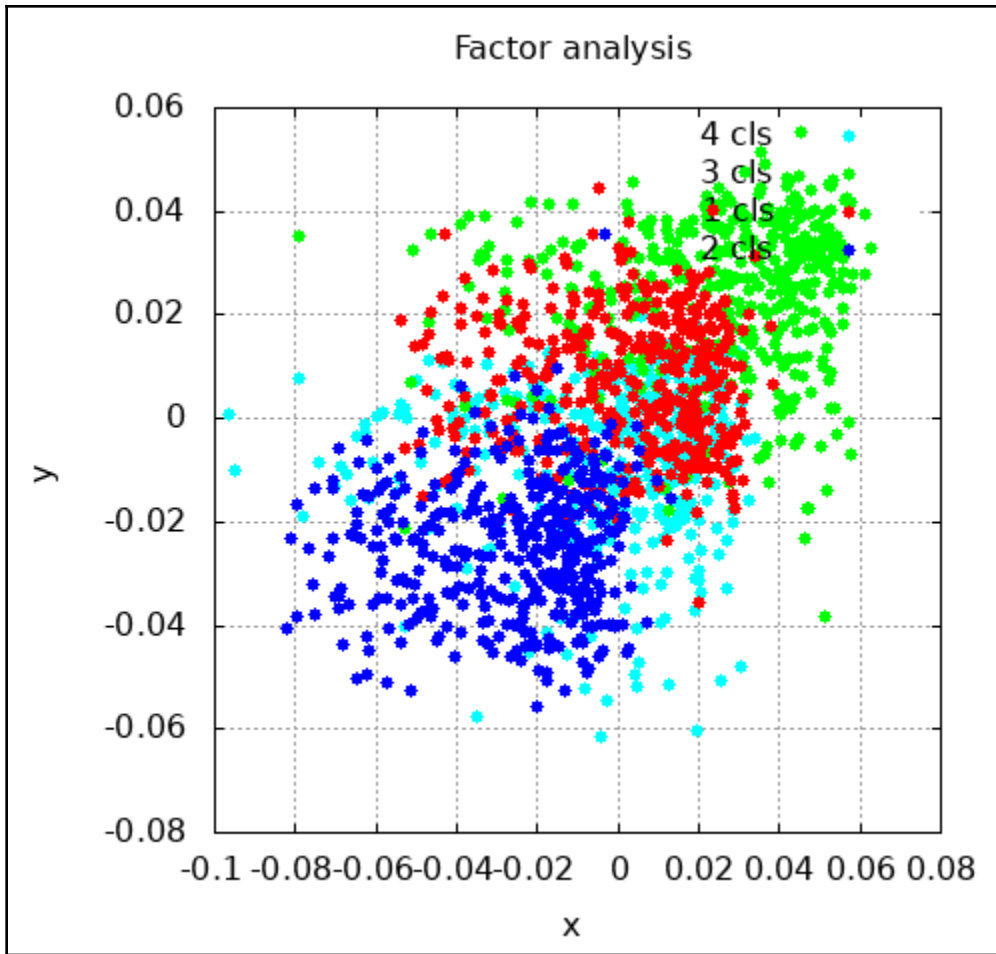

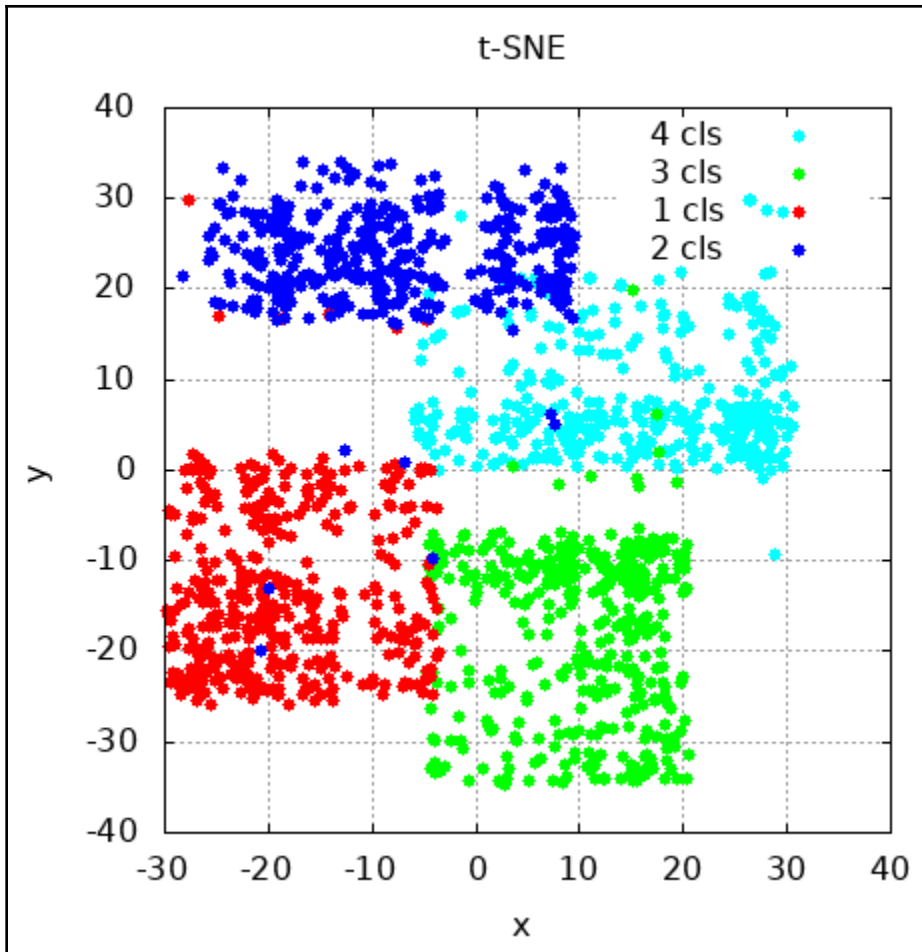

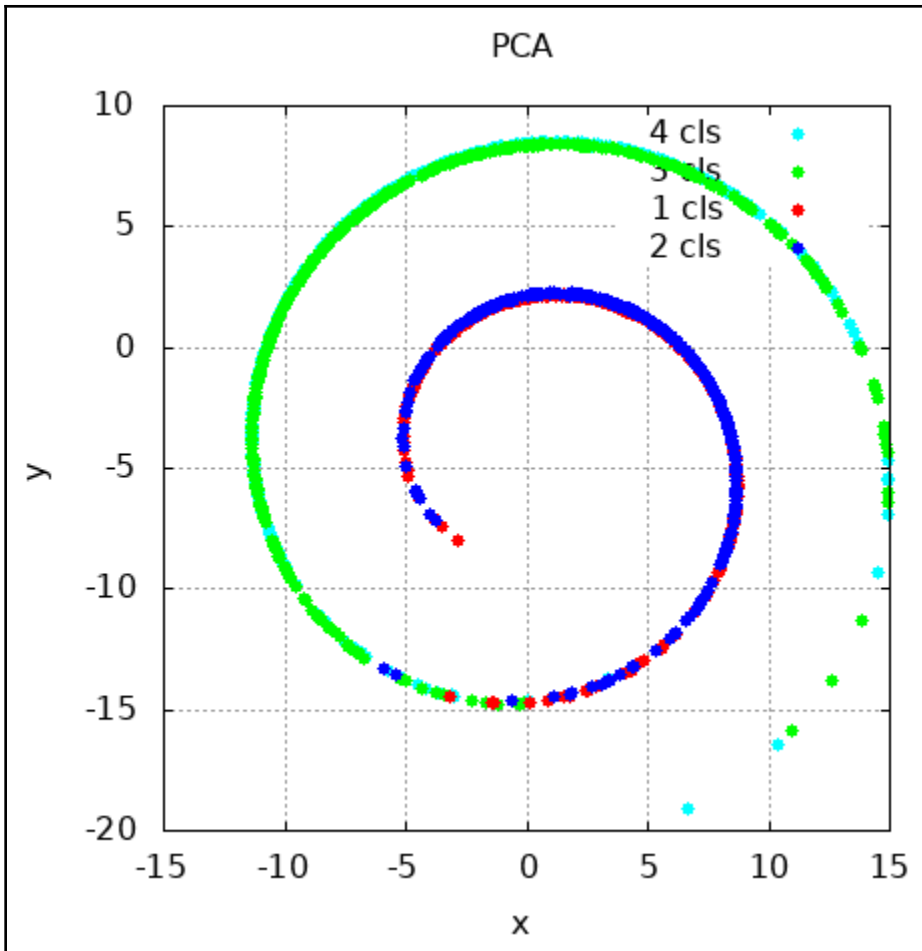

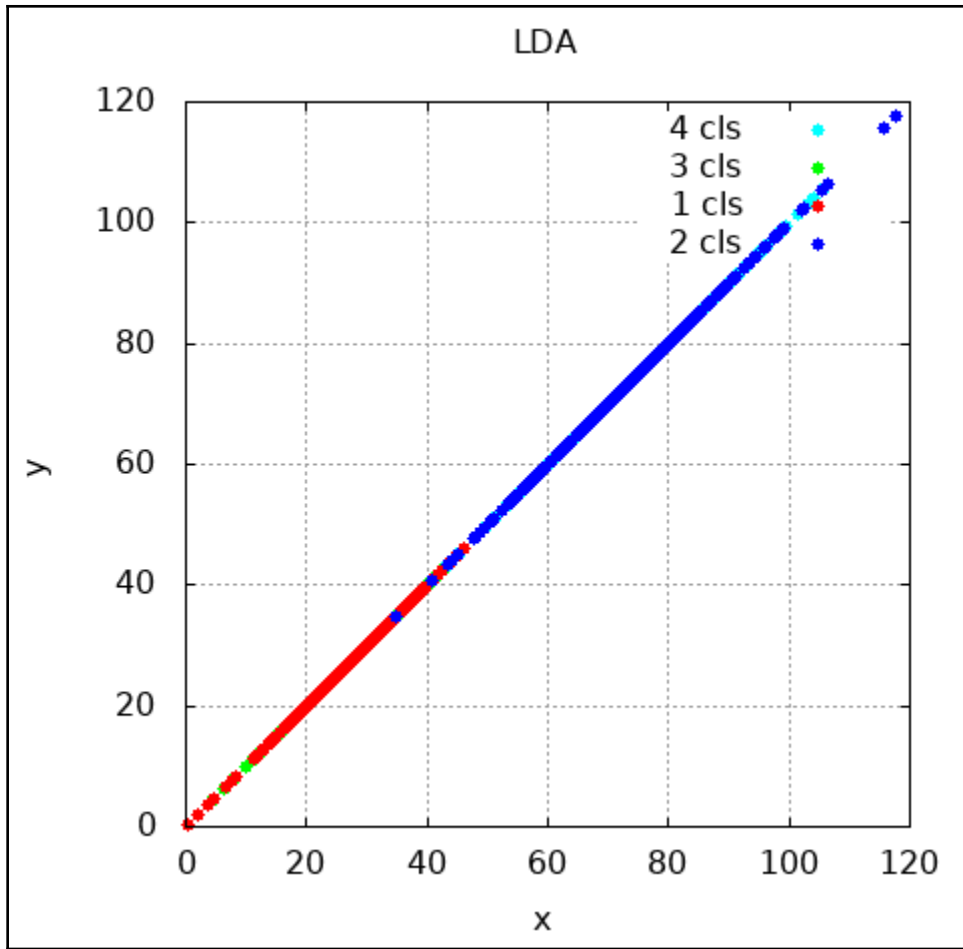

Chapter 7: Classification

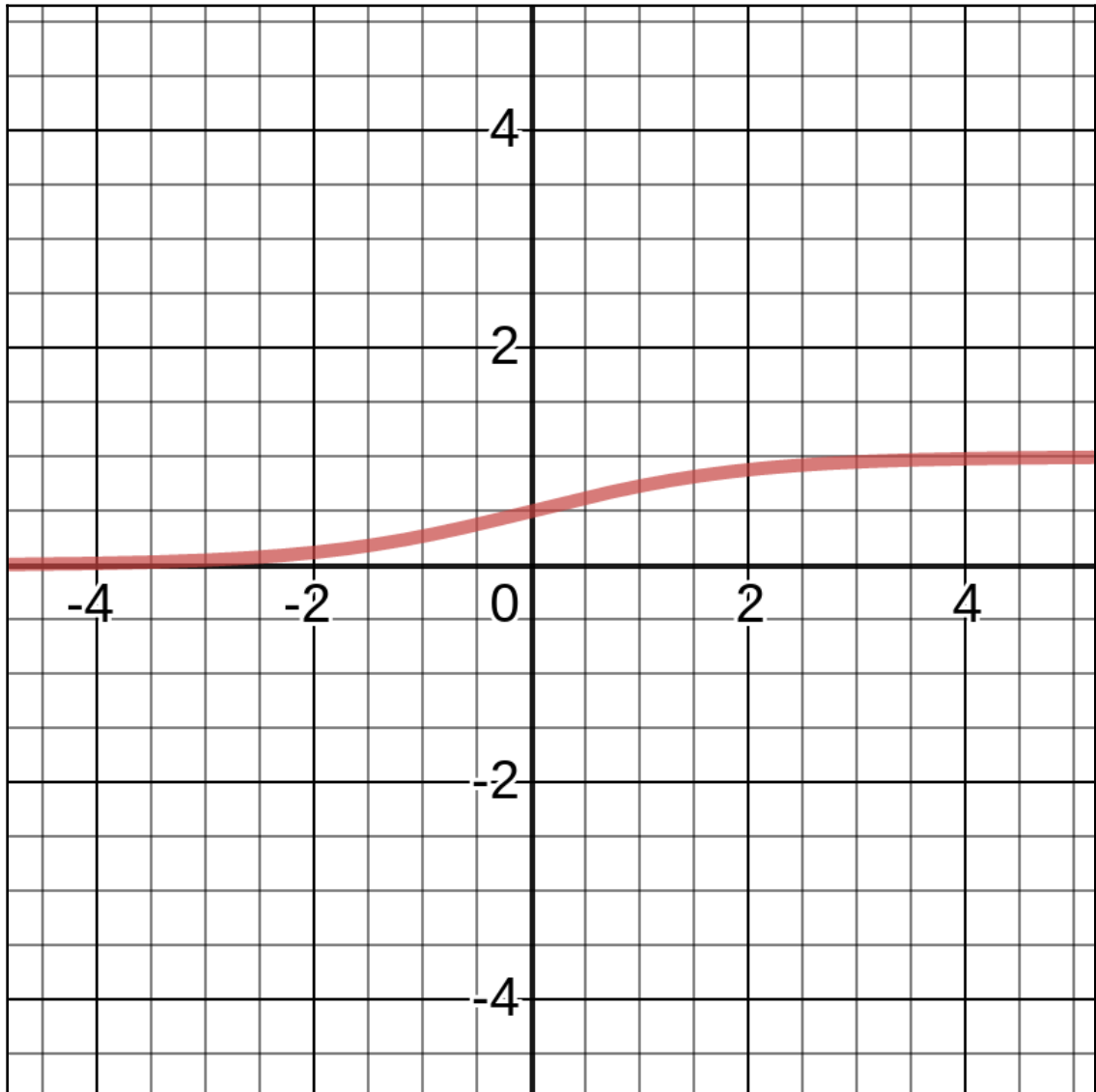

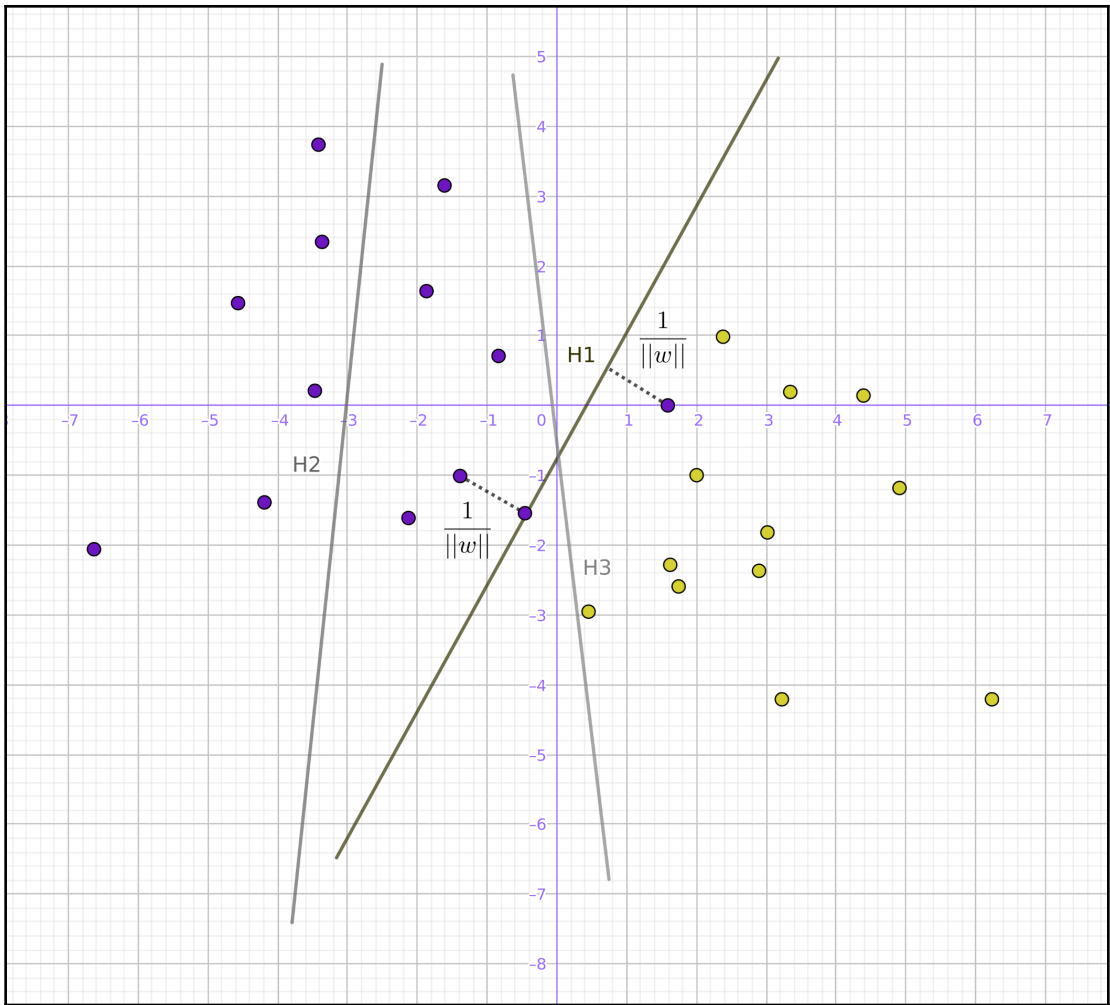

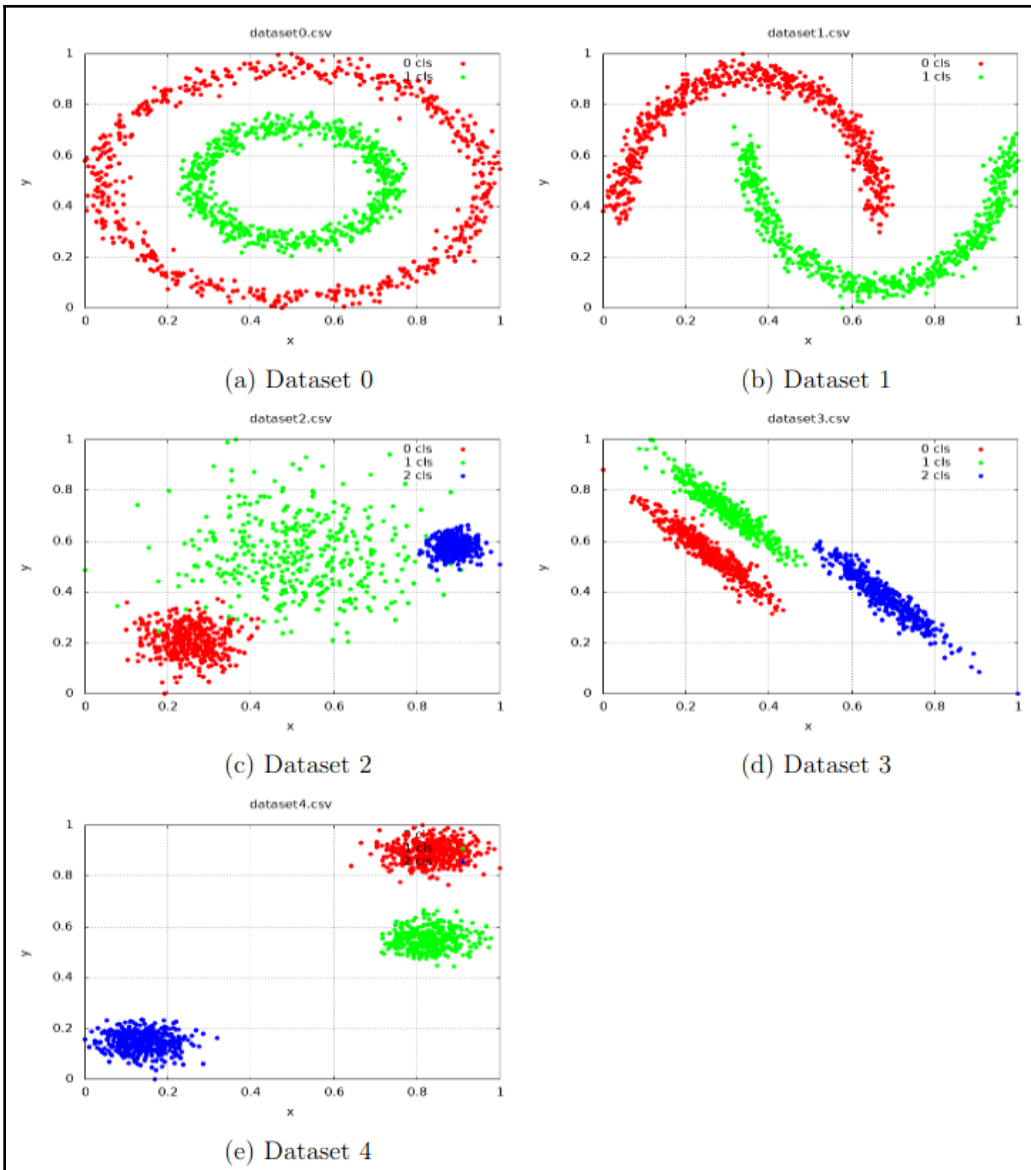

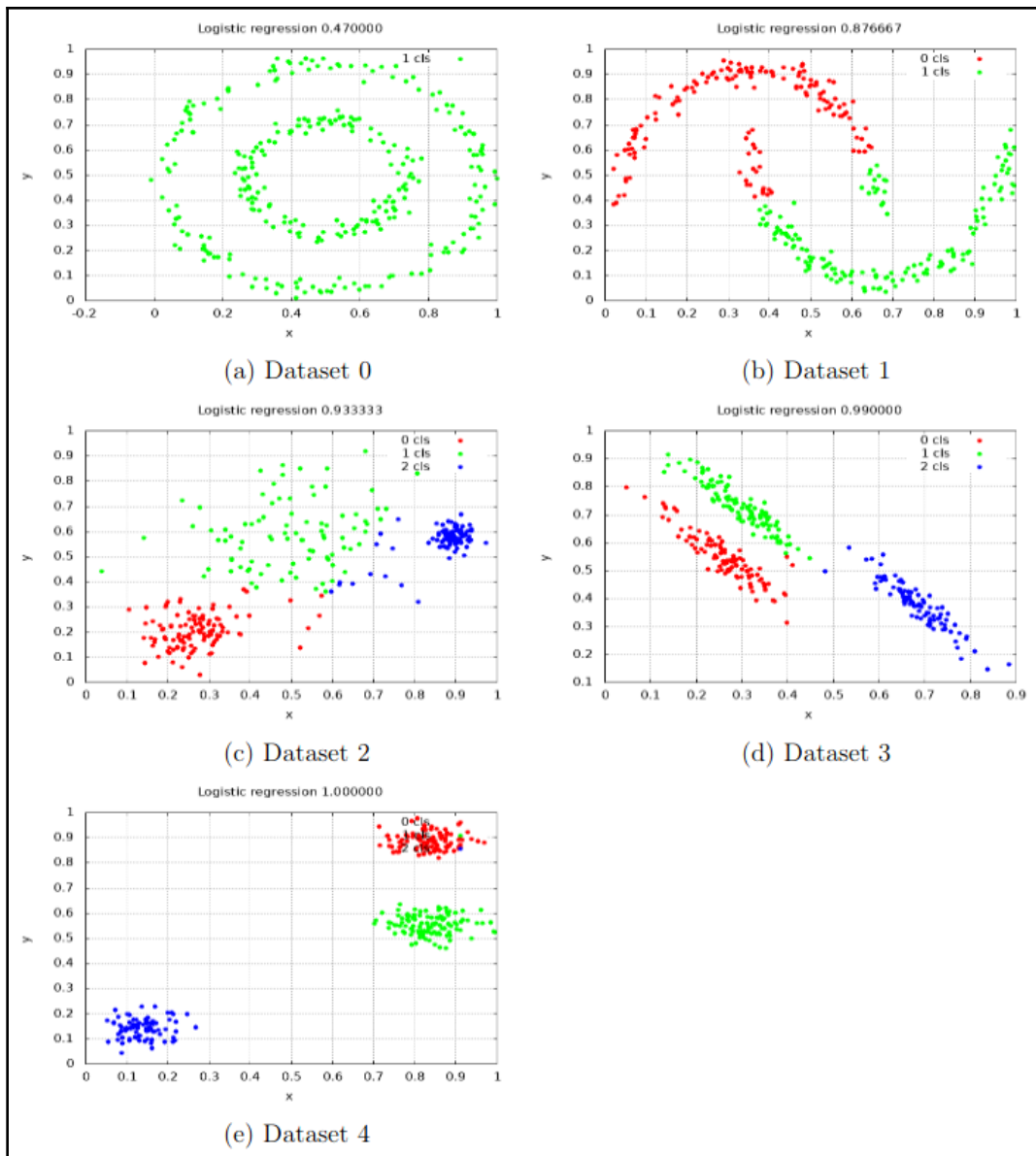

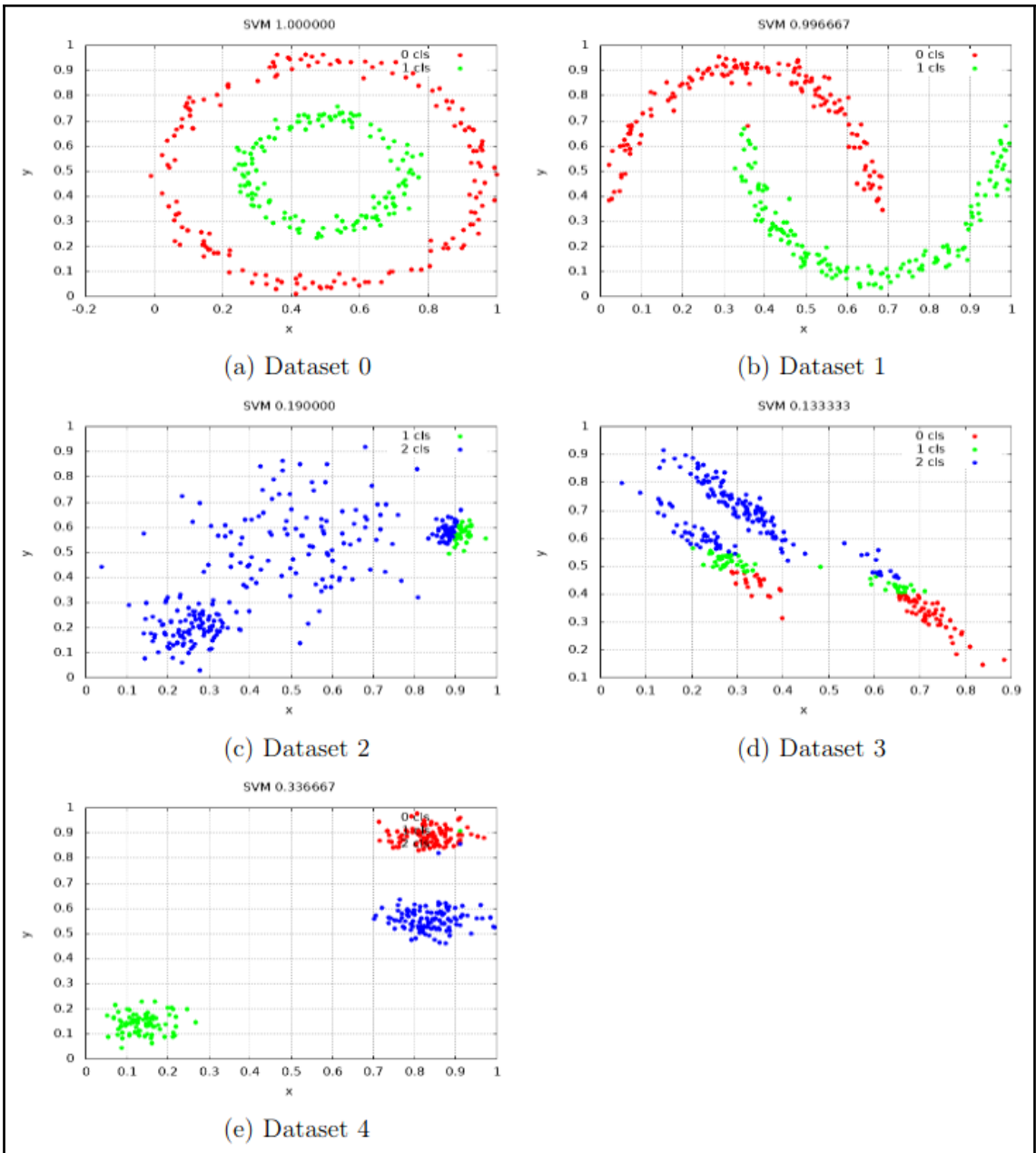

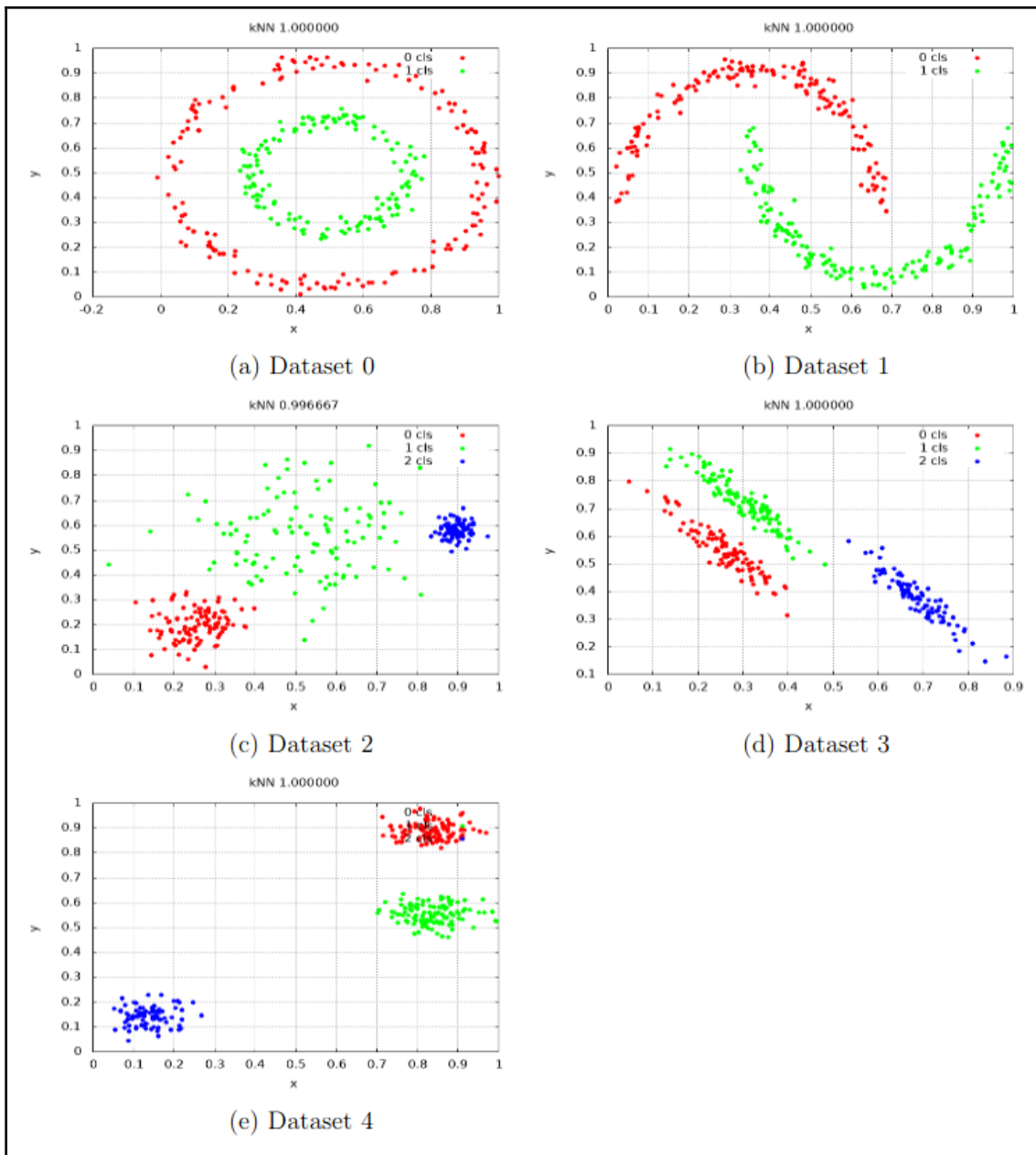

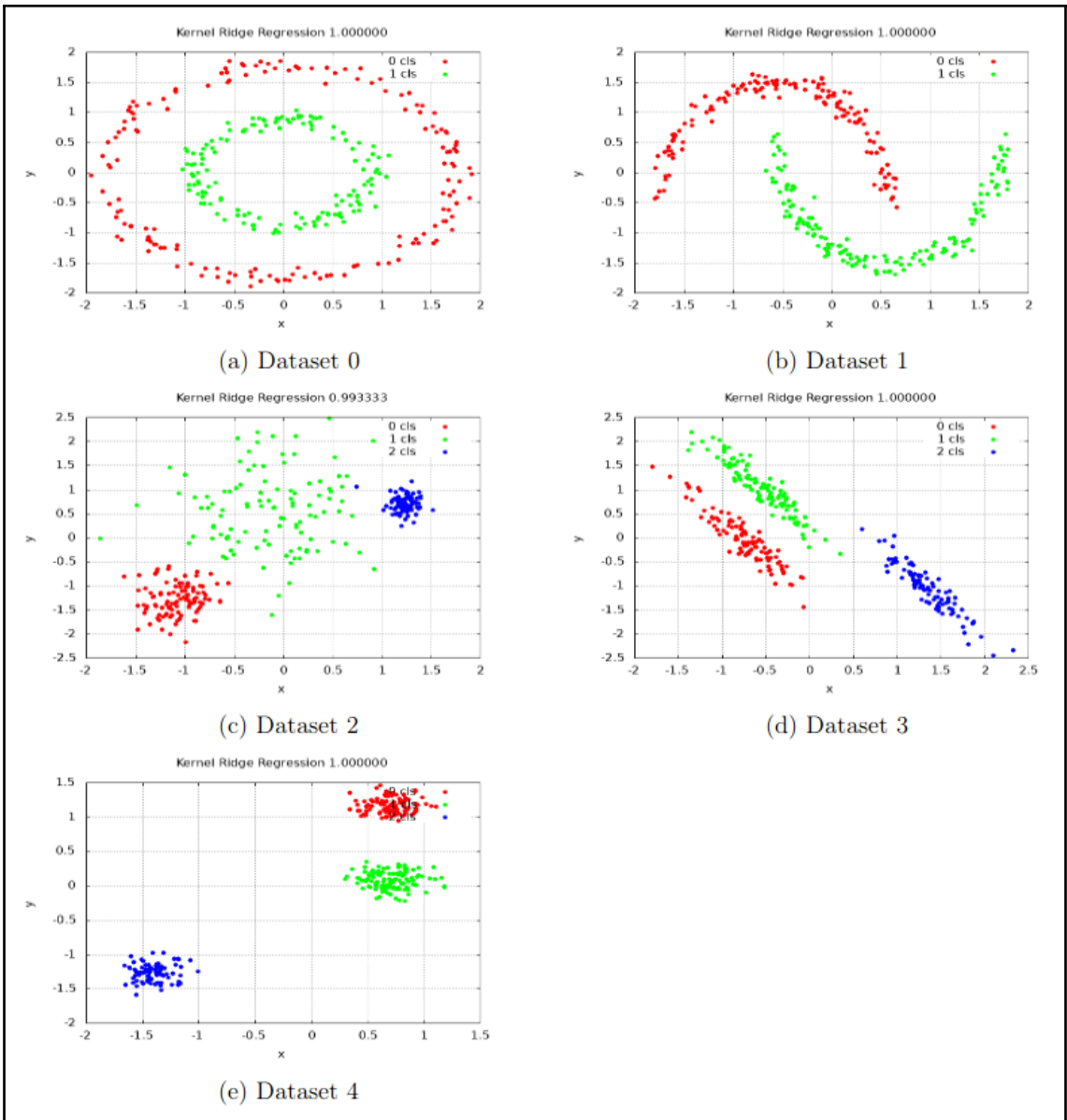

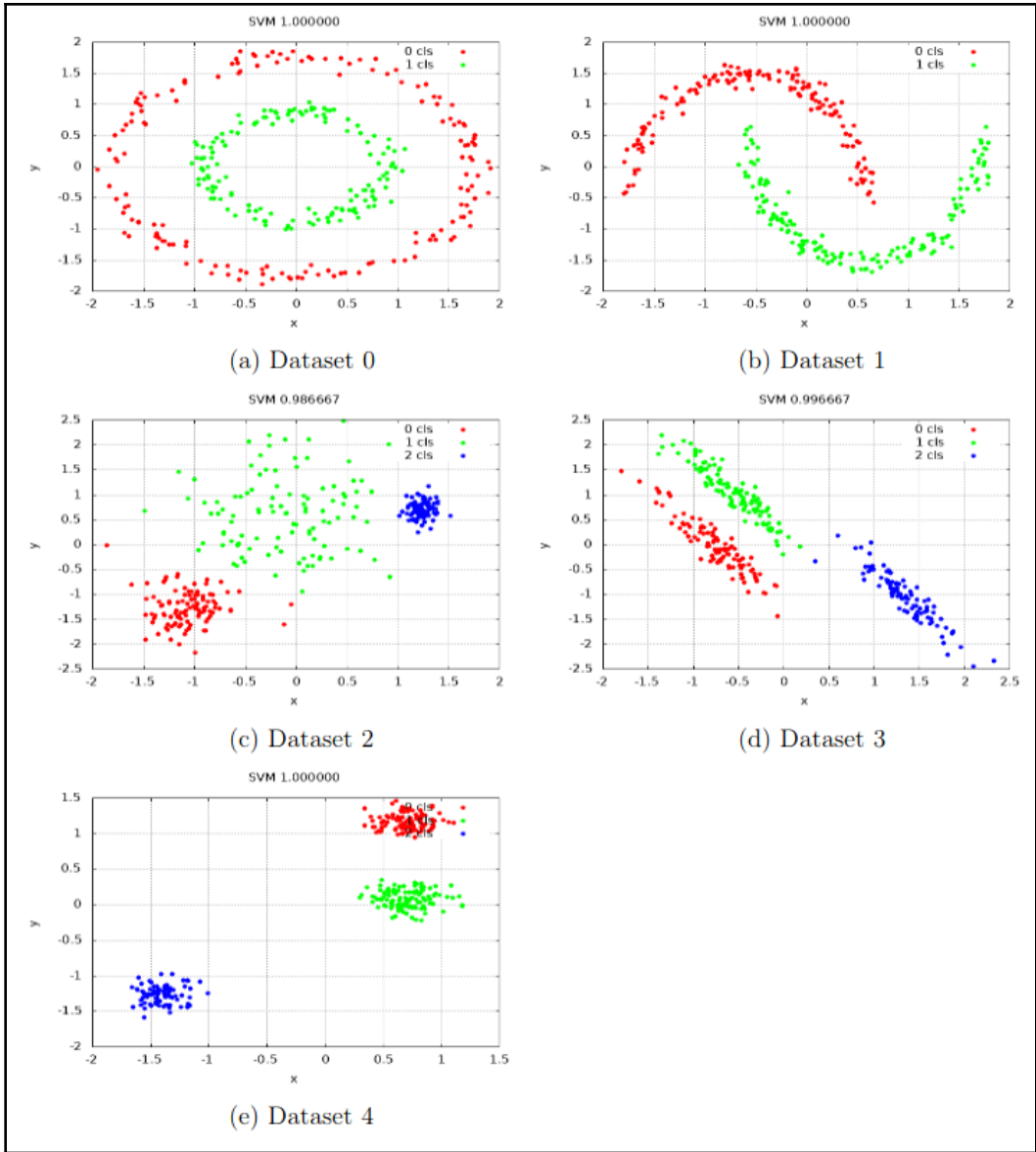

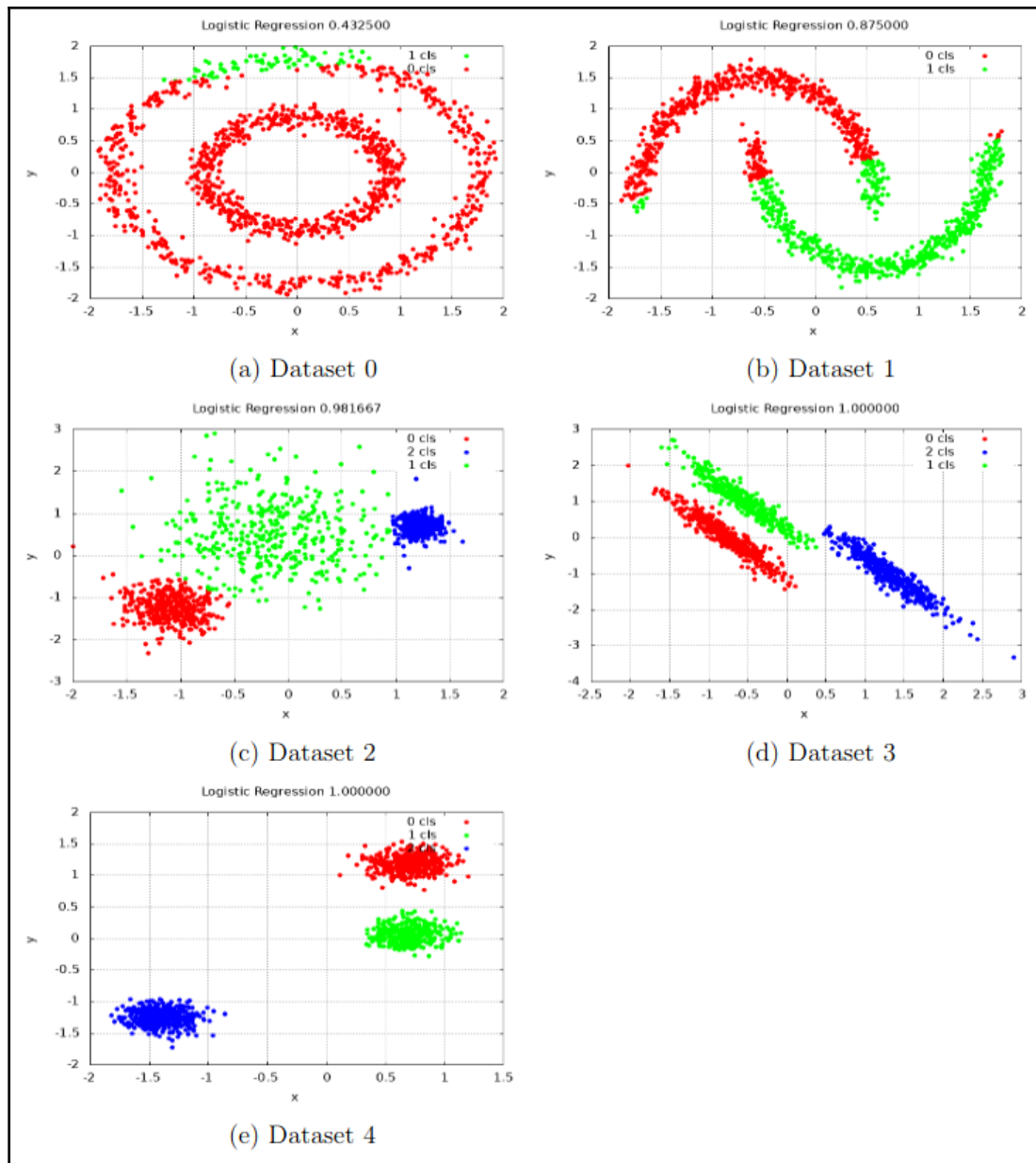

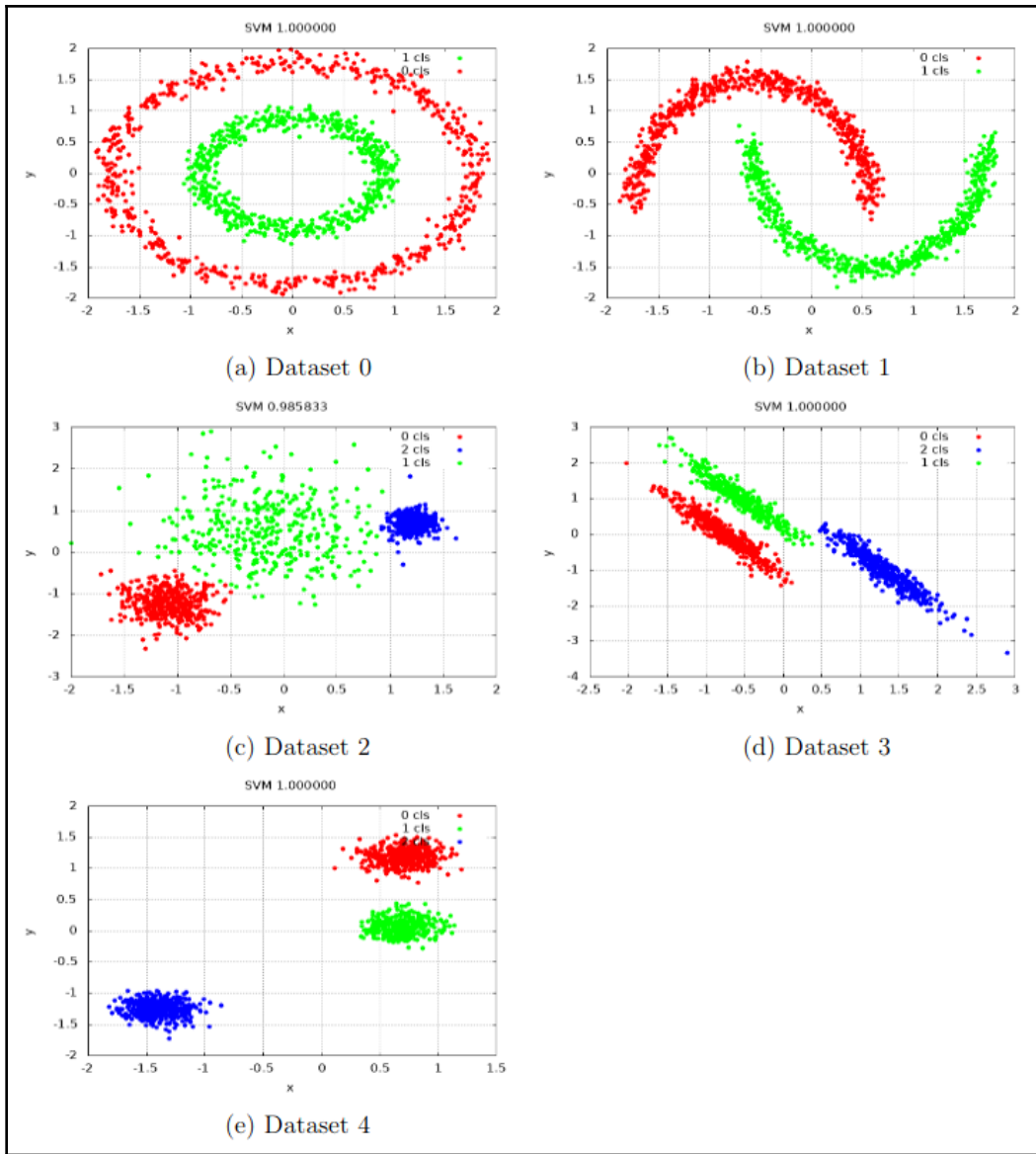

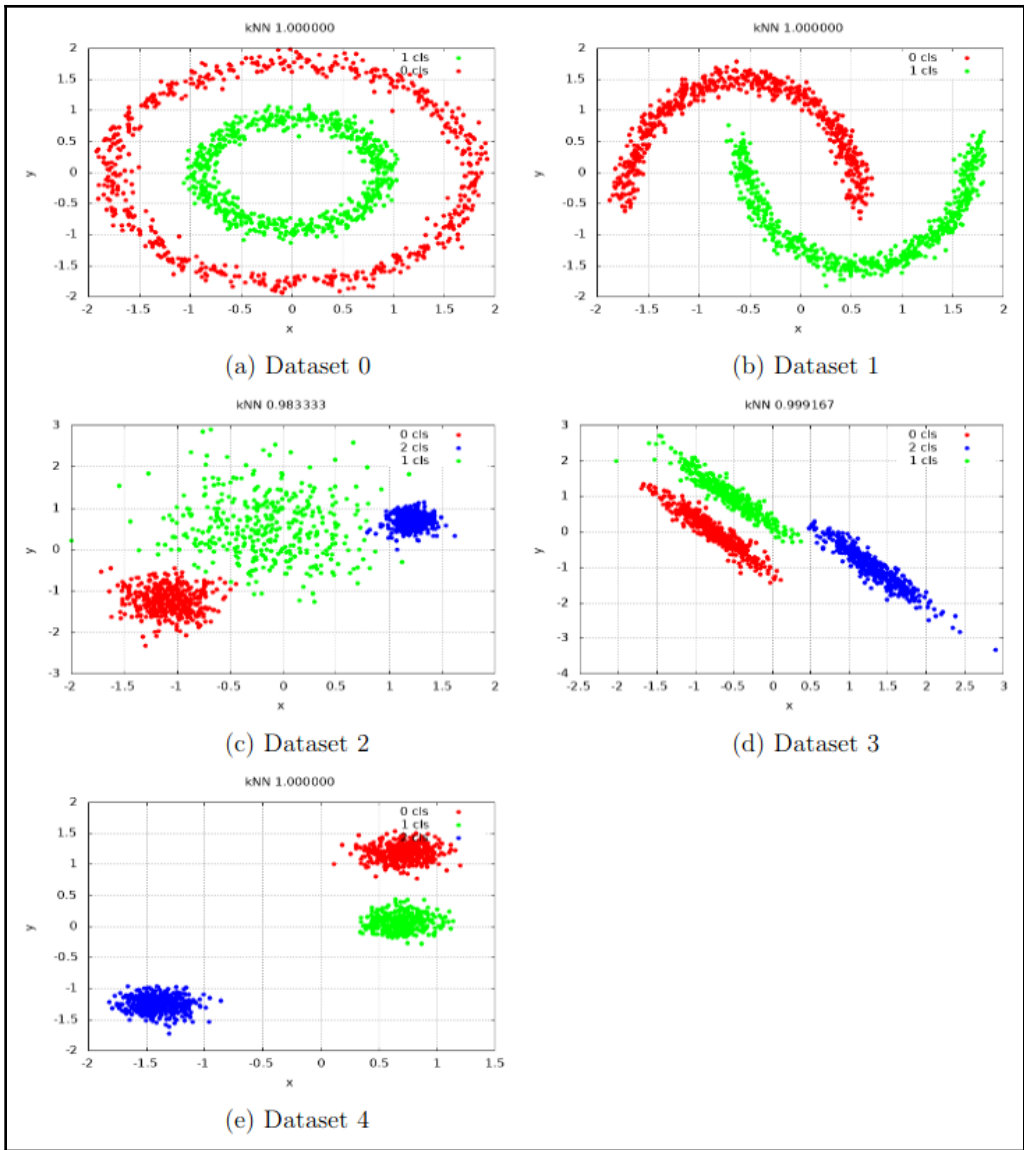

Chapter 9: Ensemble Learning

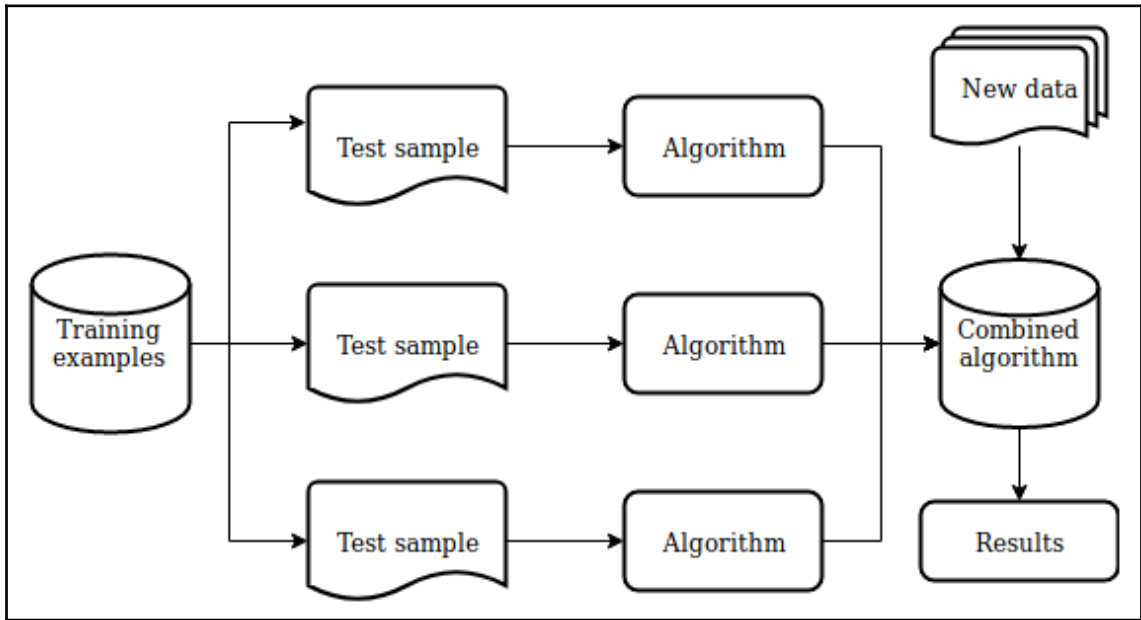

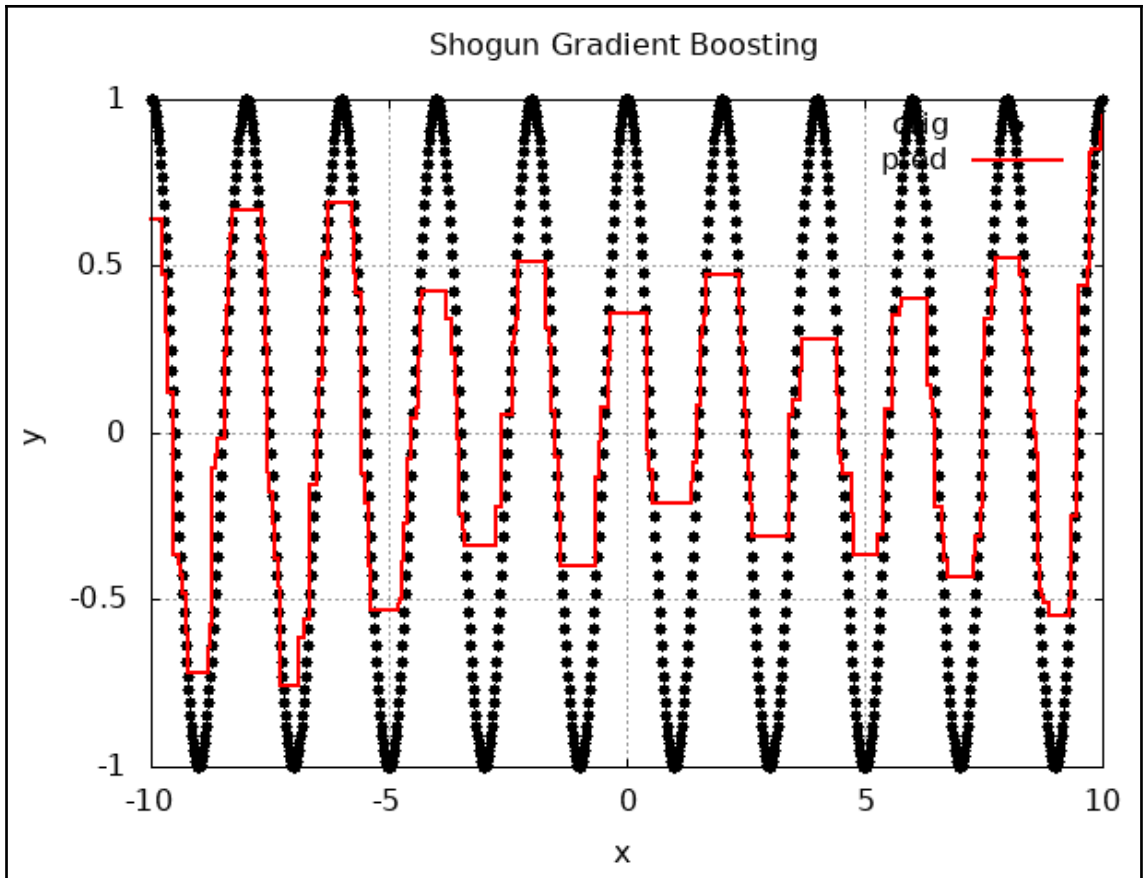

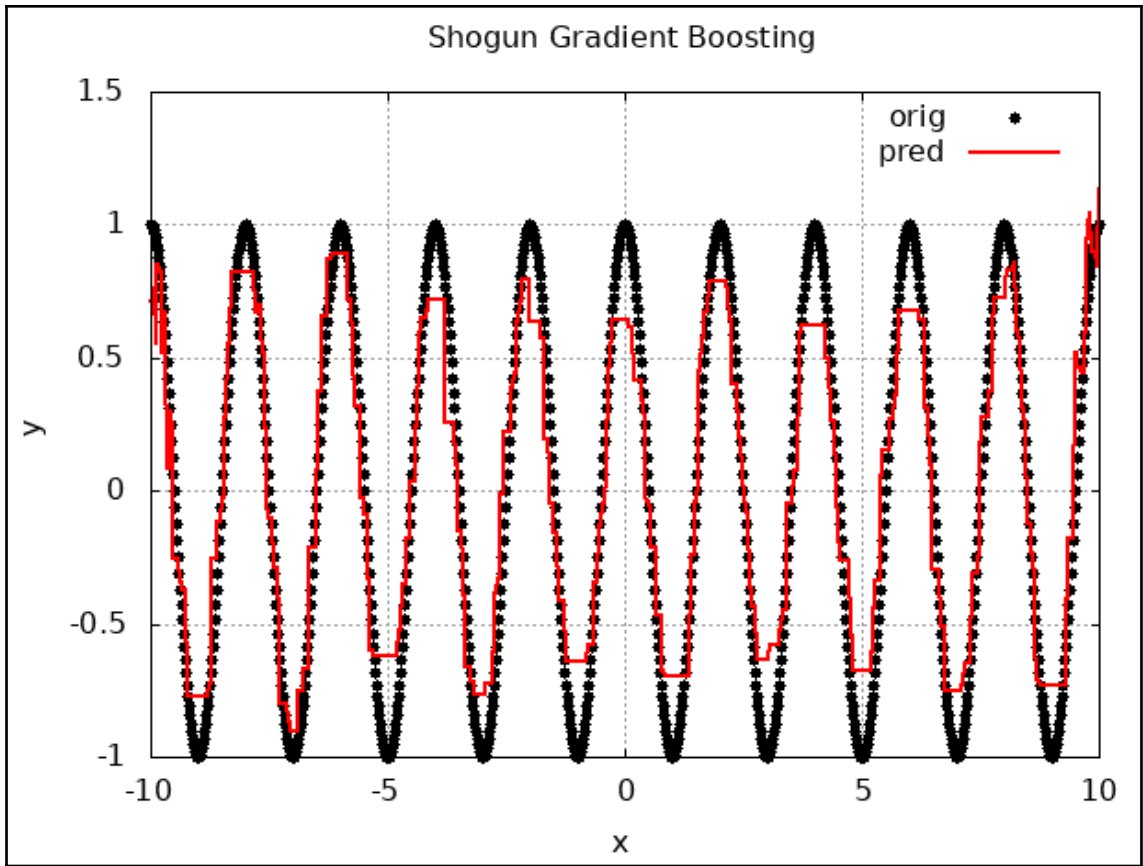

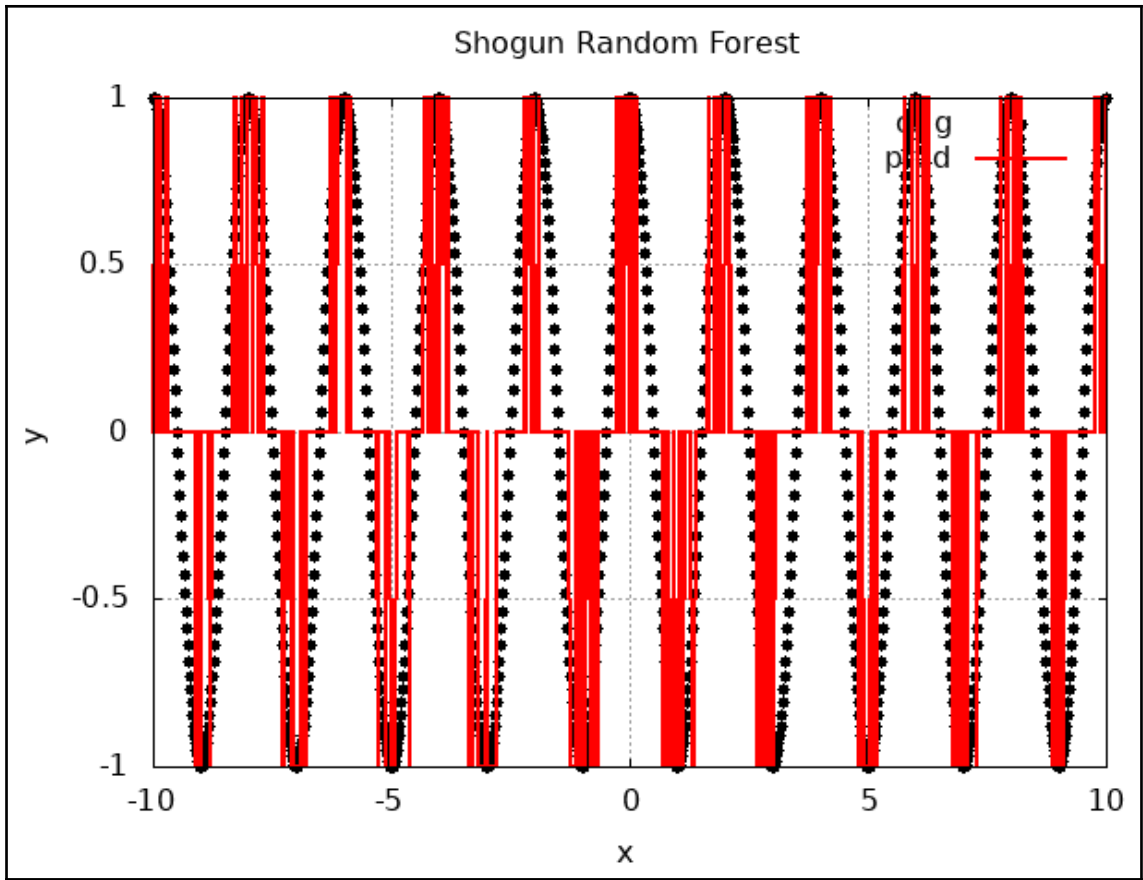

Chapter 10: Neural Networks for Image Classification

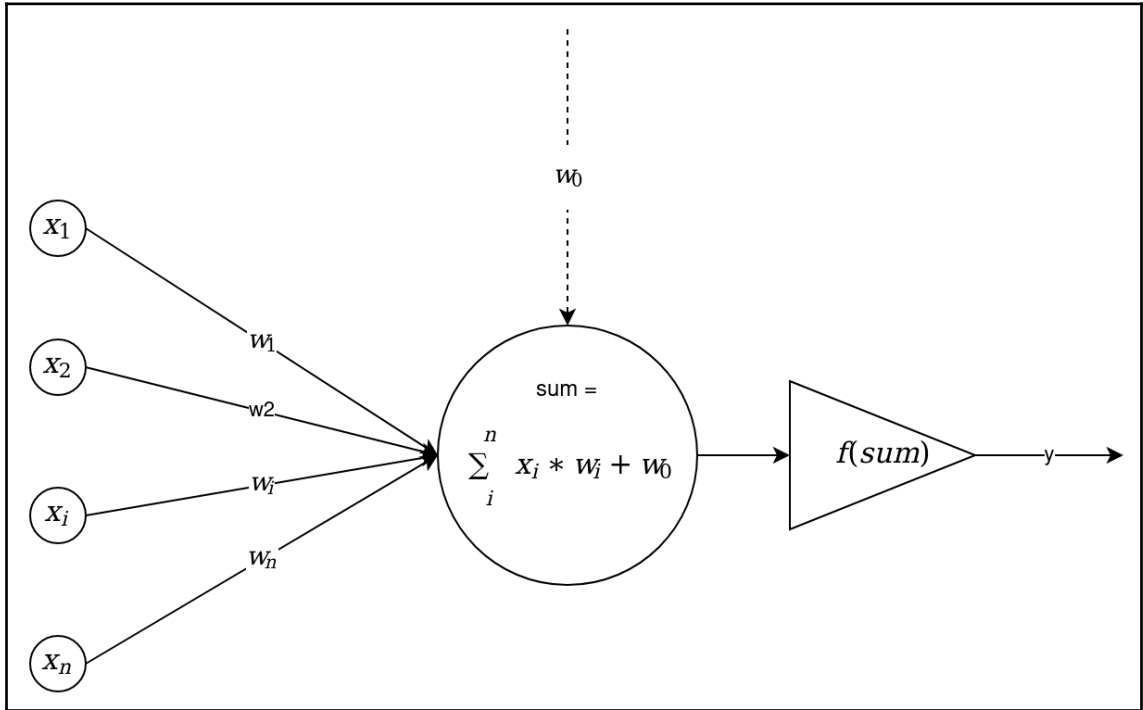

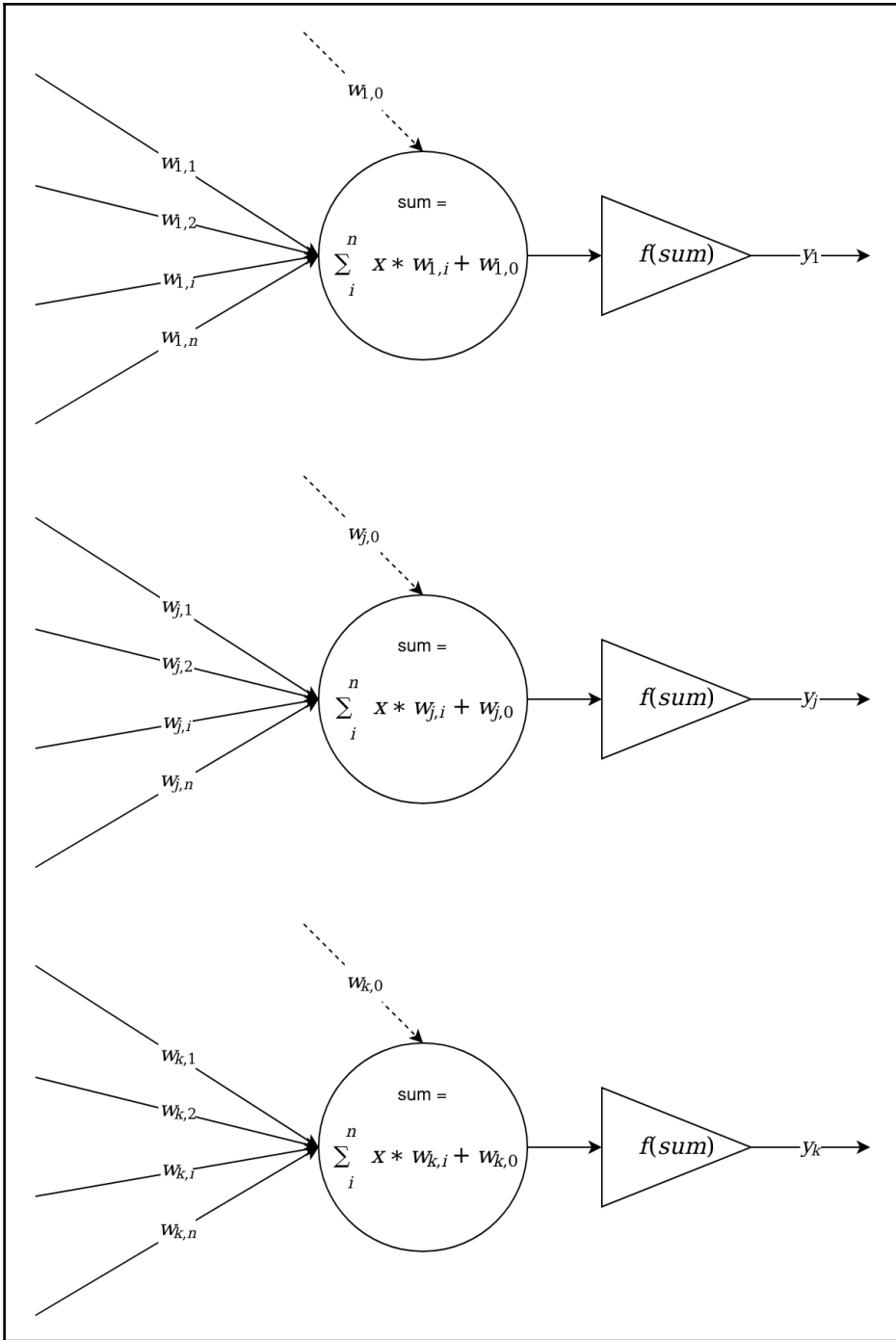

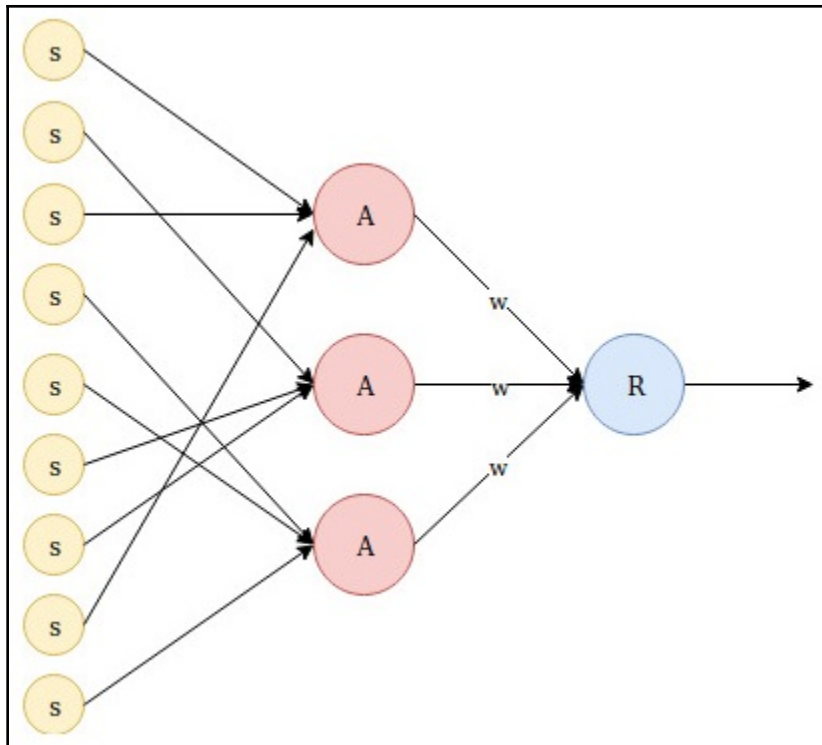

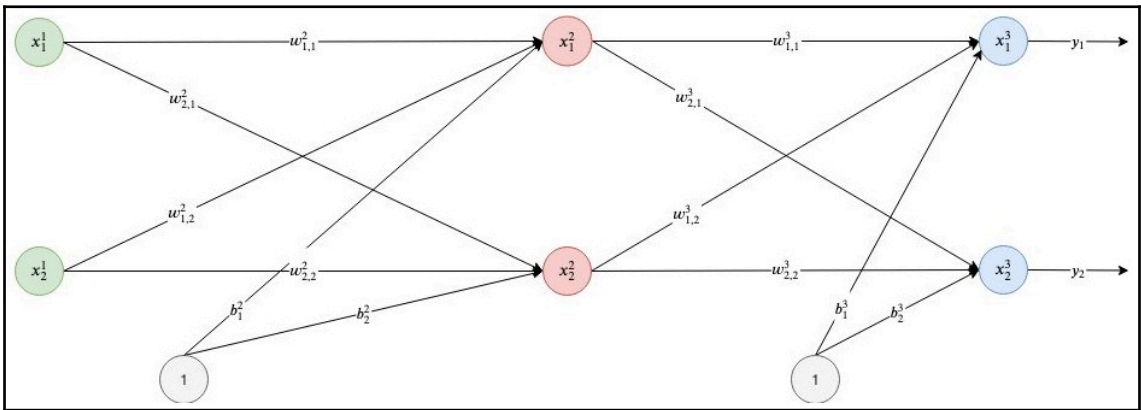
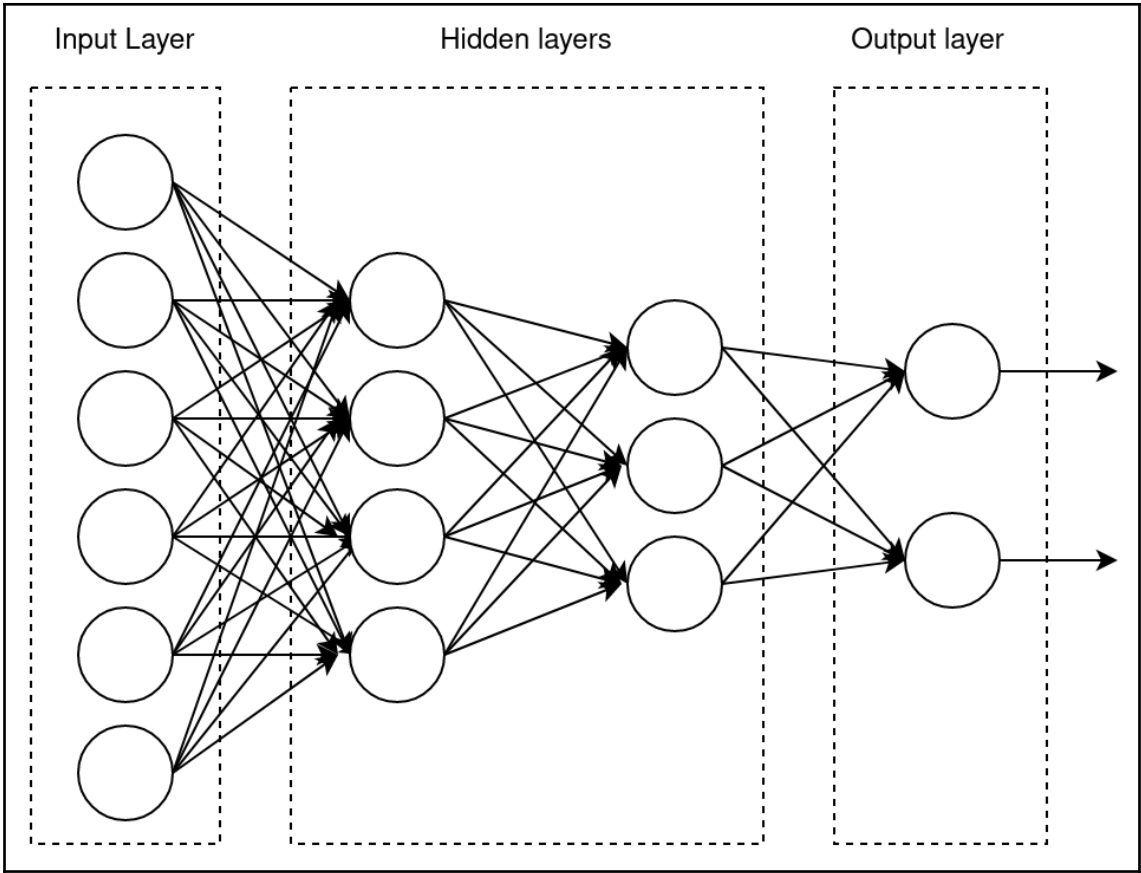

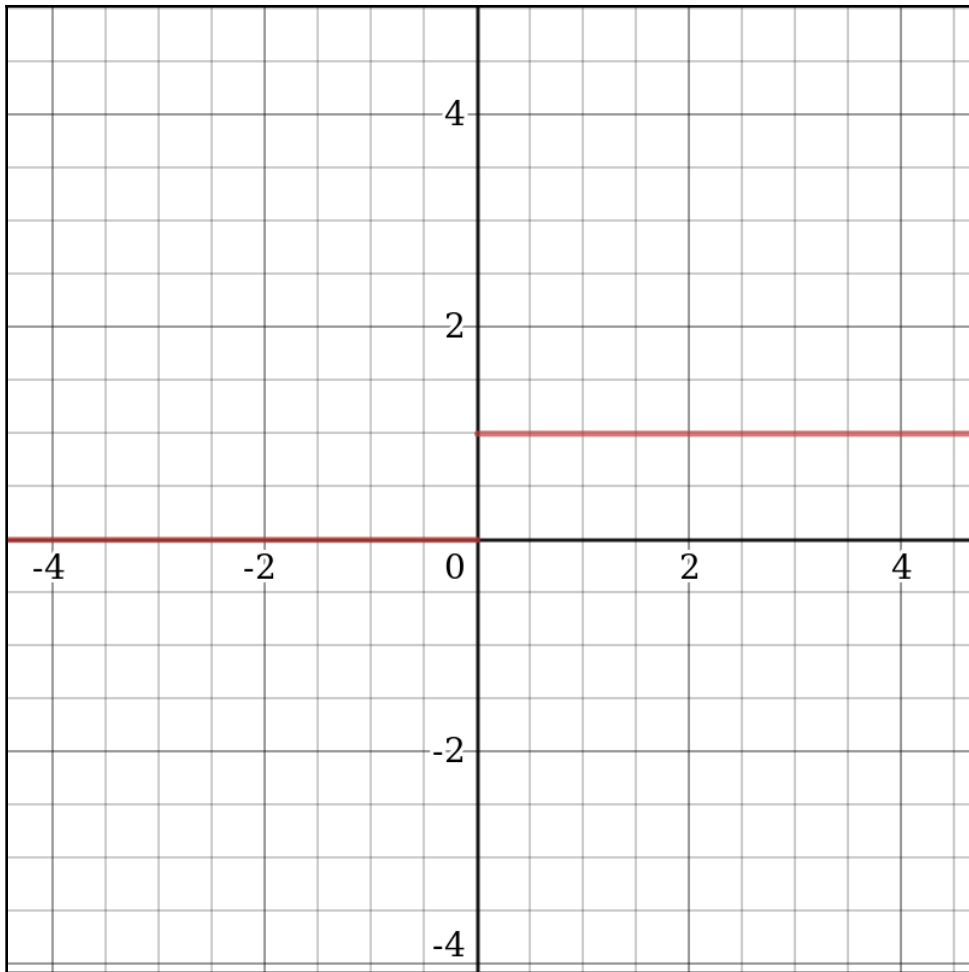

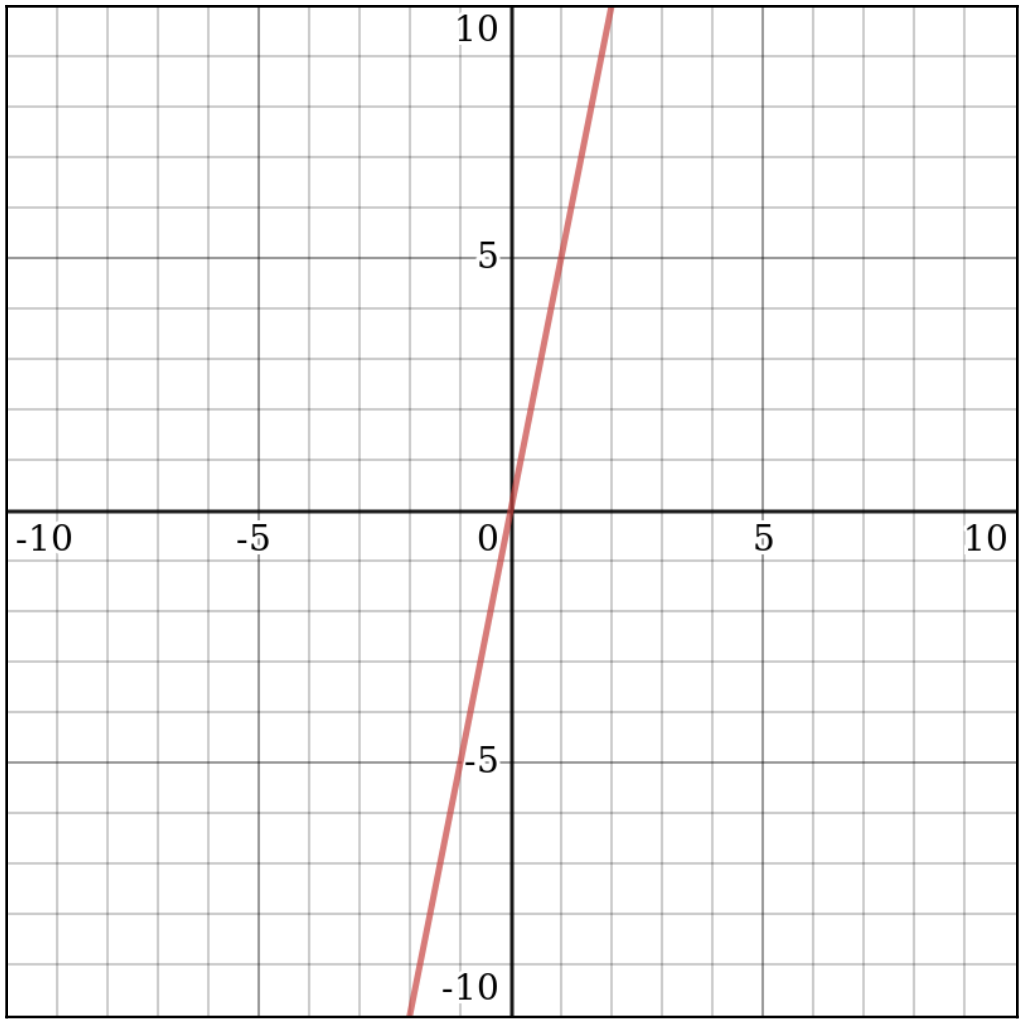

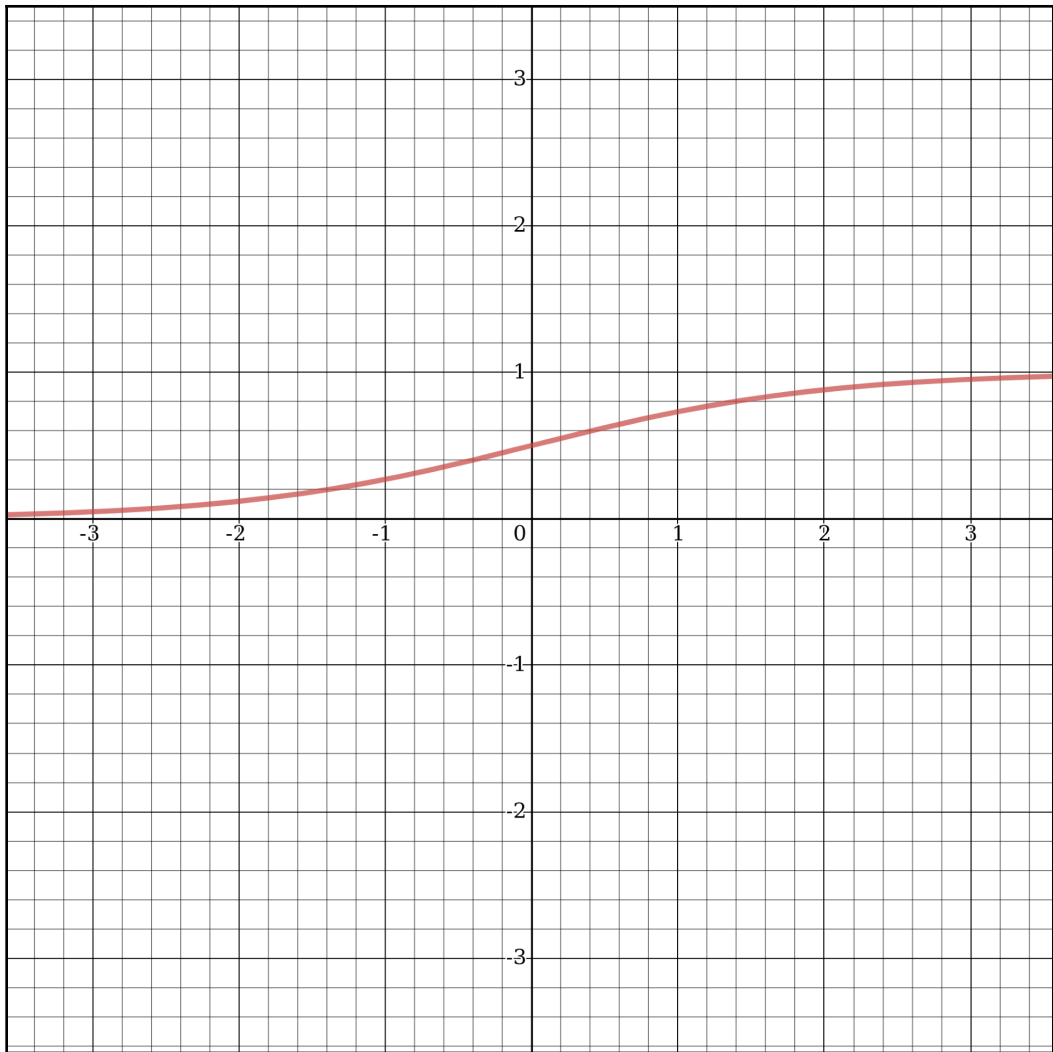

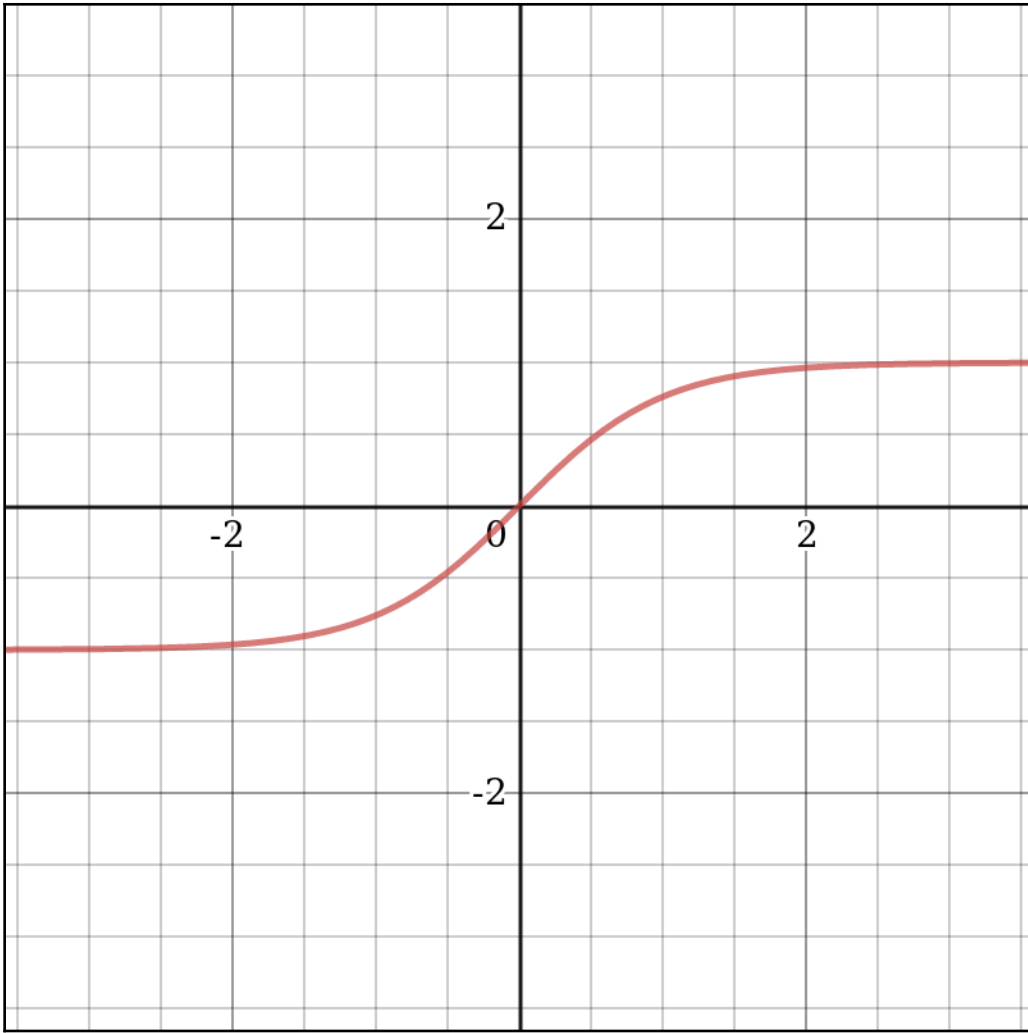

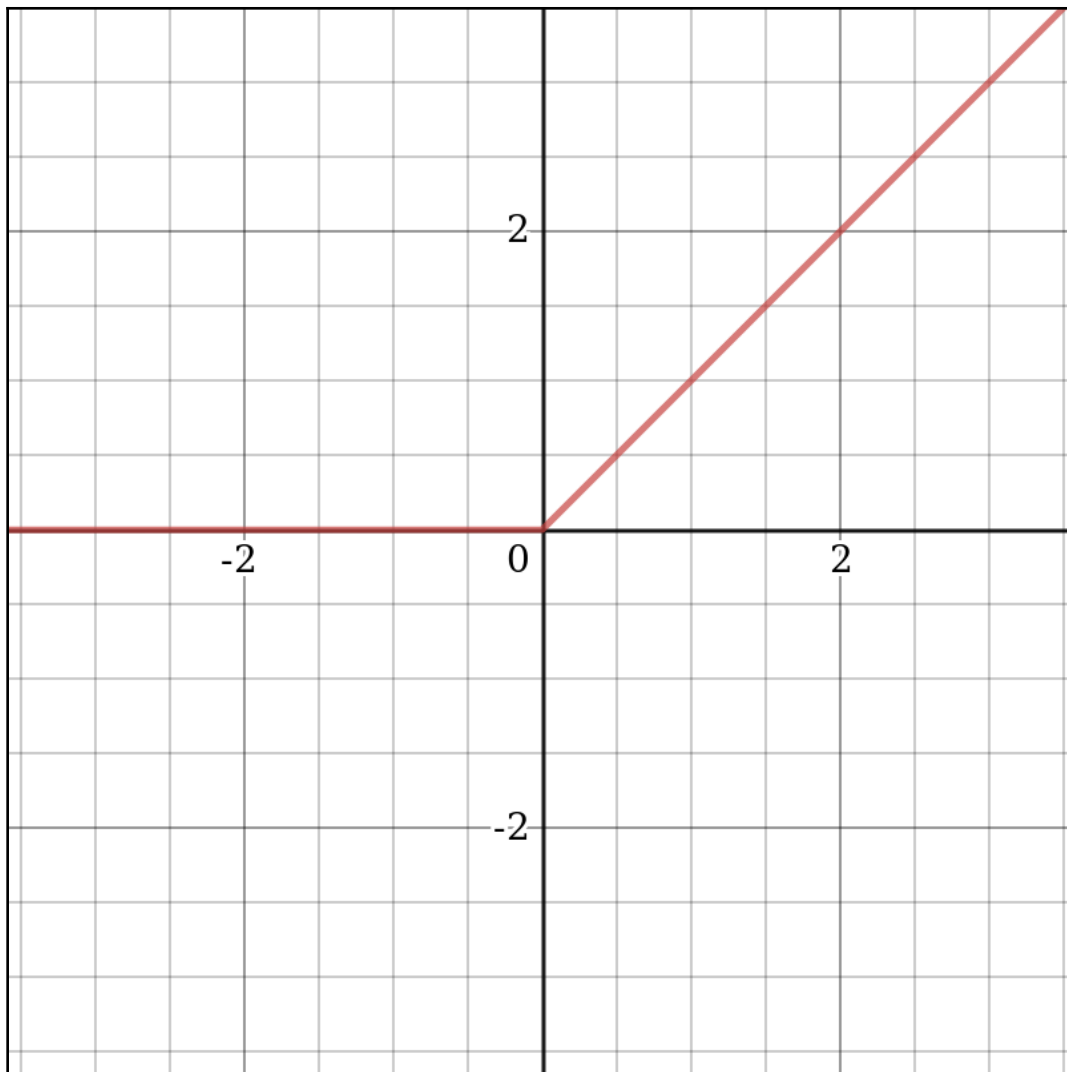

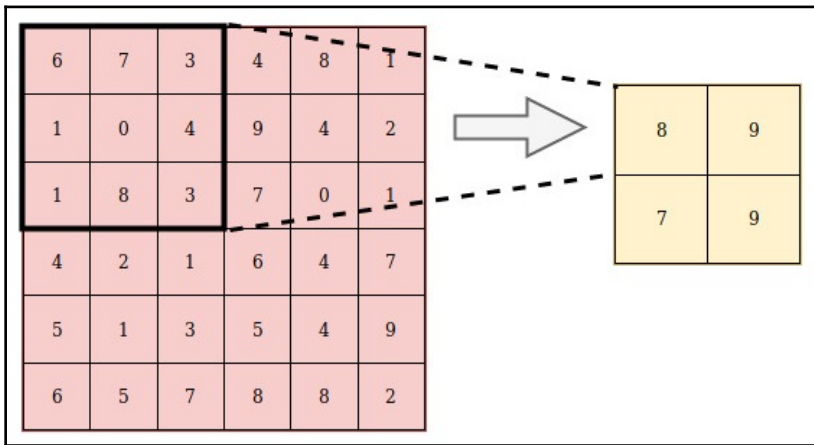
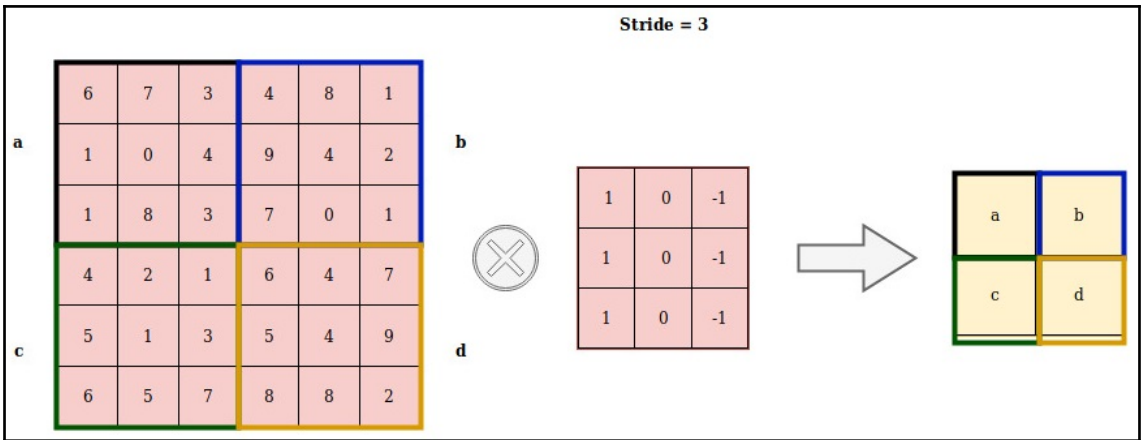
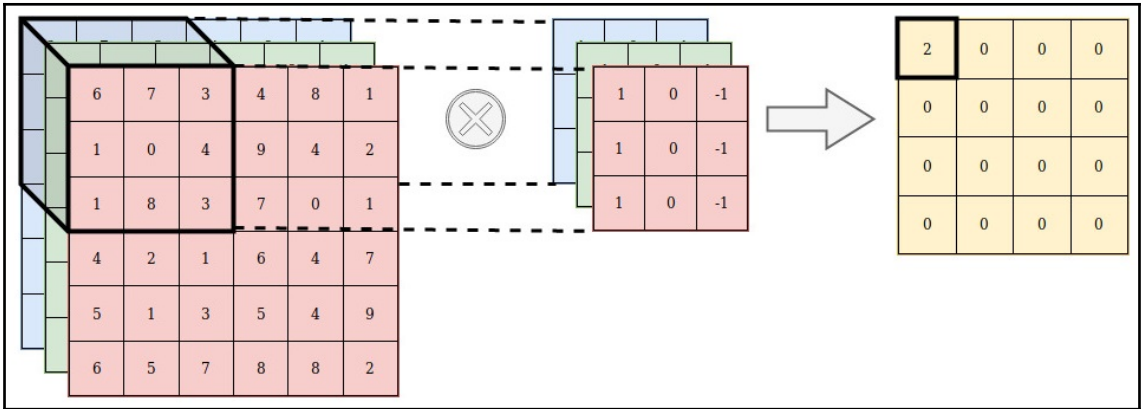

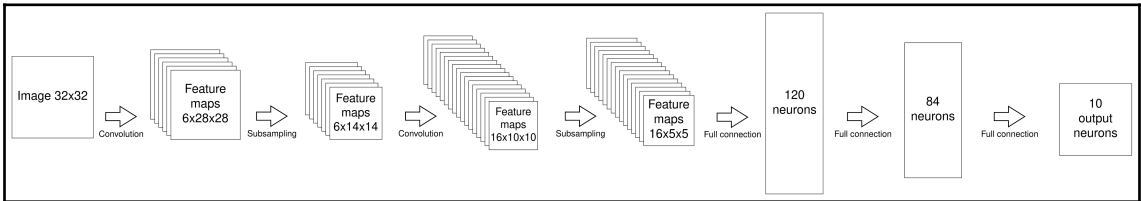
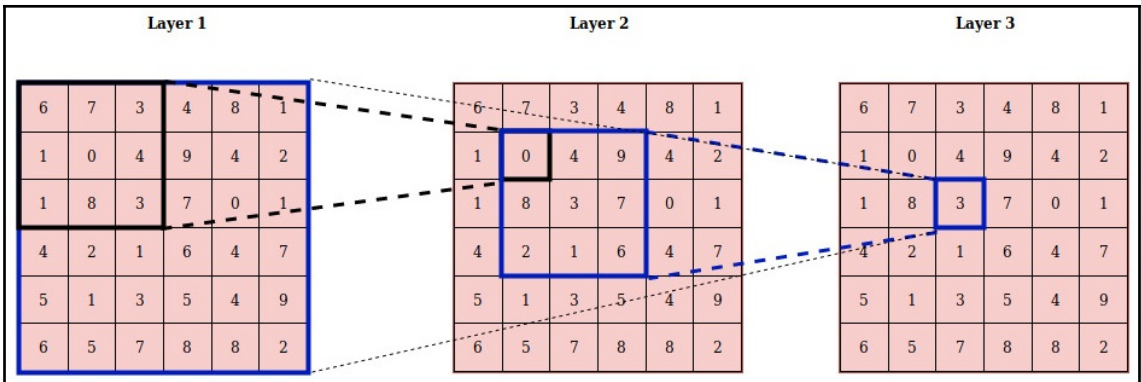

Chapter 11: Sentiment Analysis with Recurrent Neural Networks

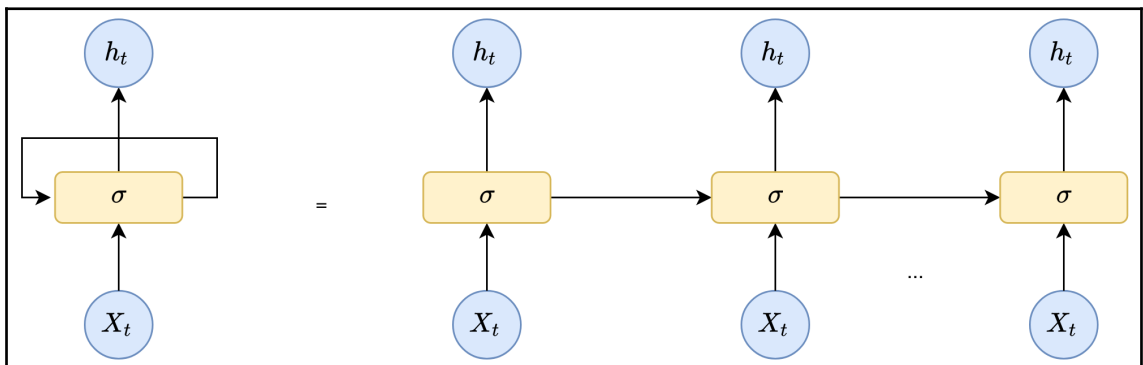
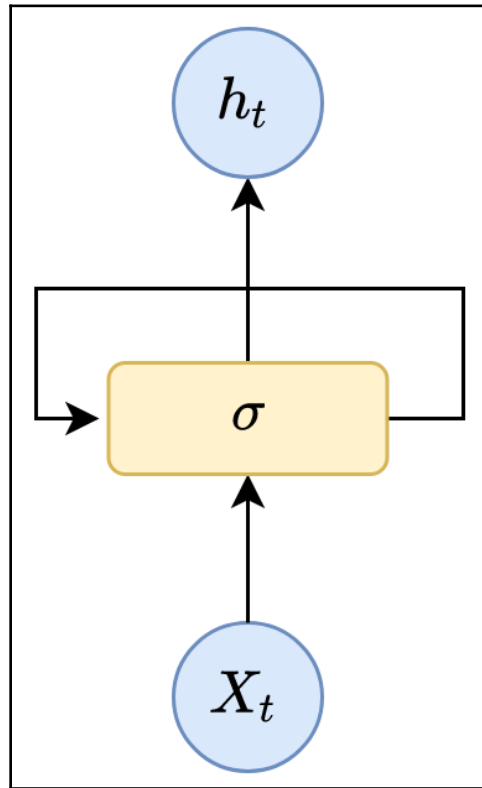

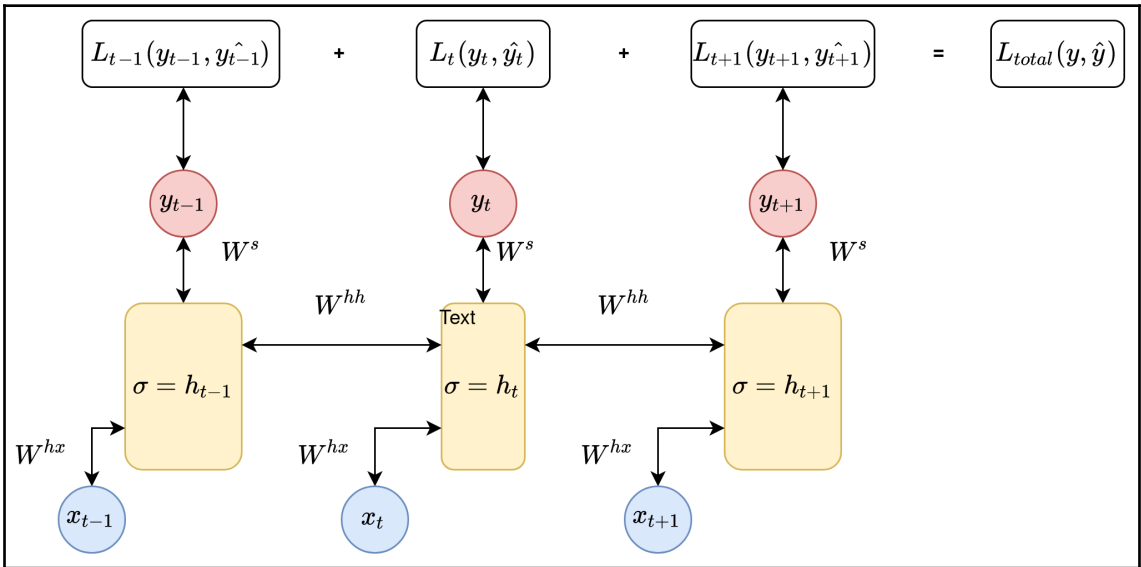
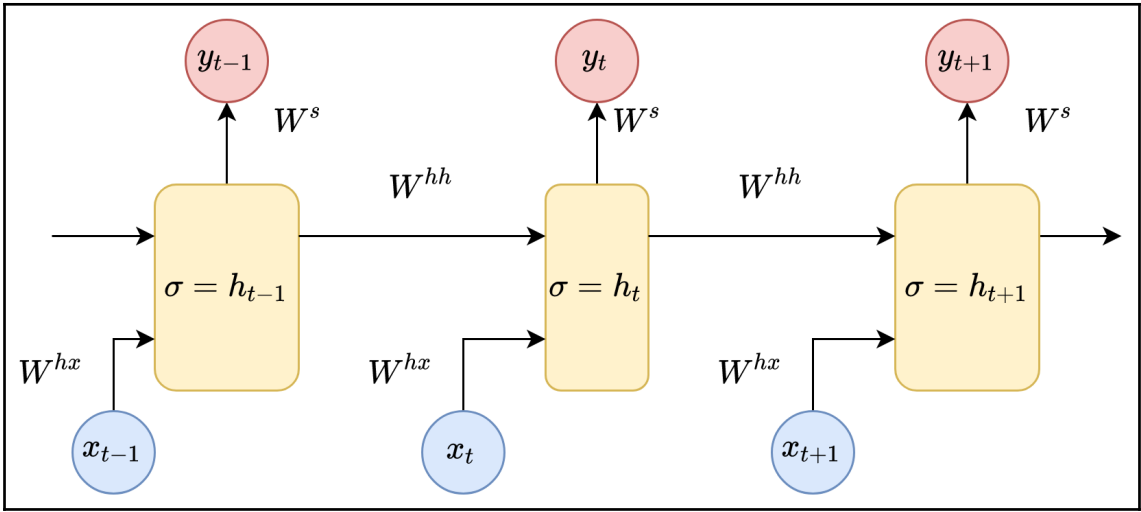

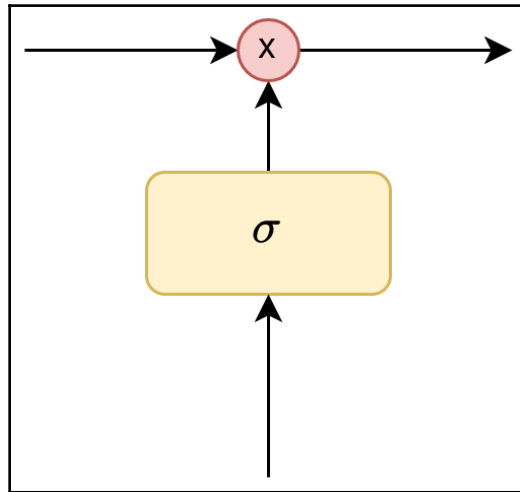
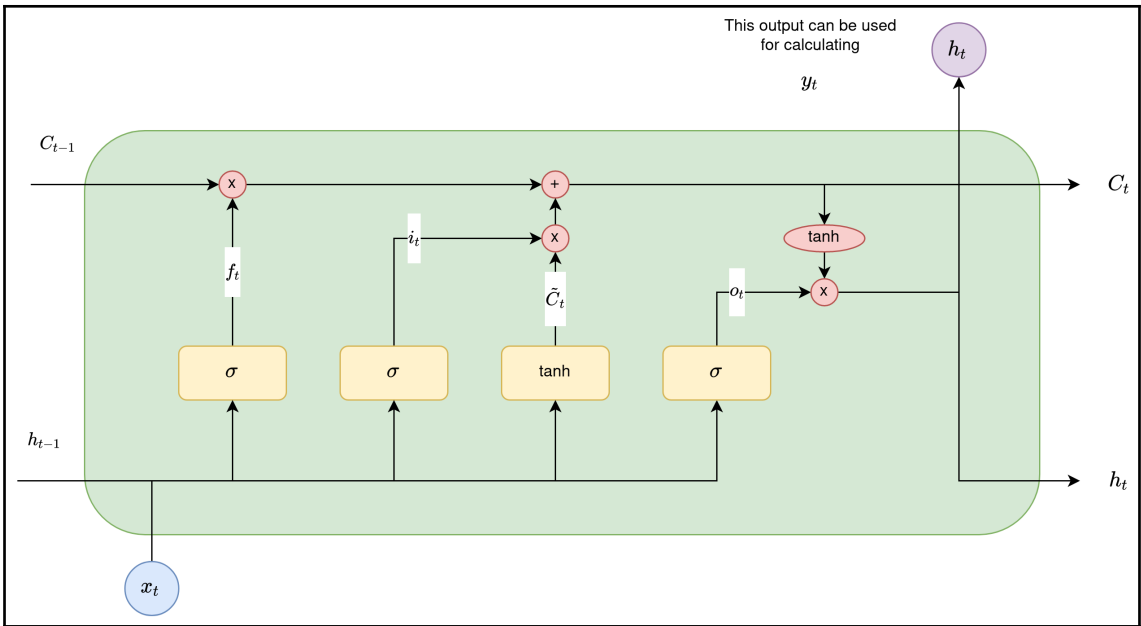

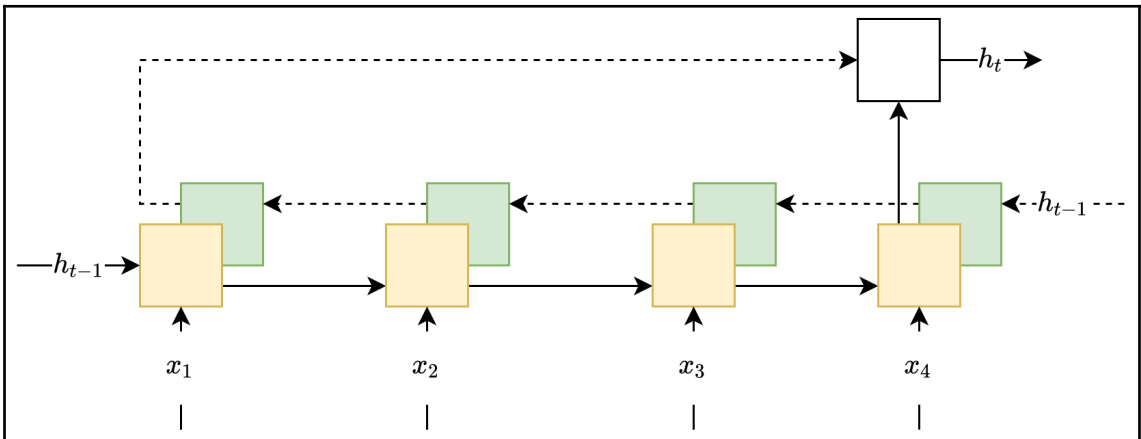
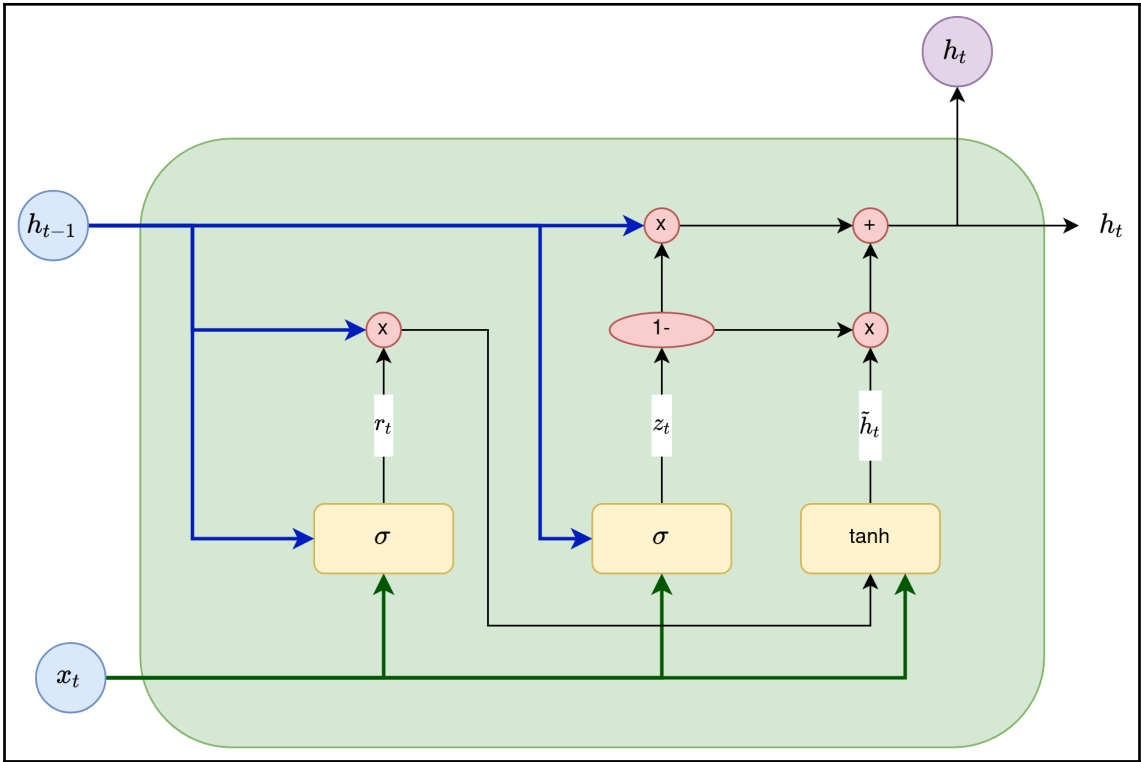

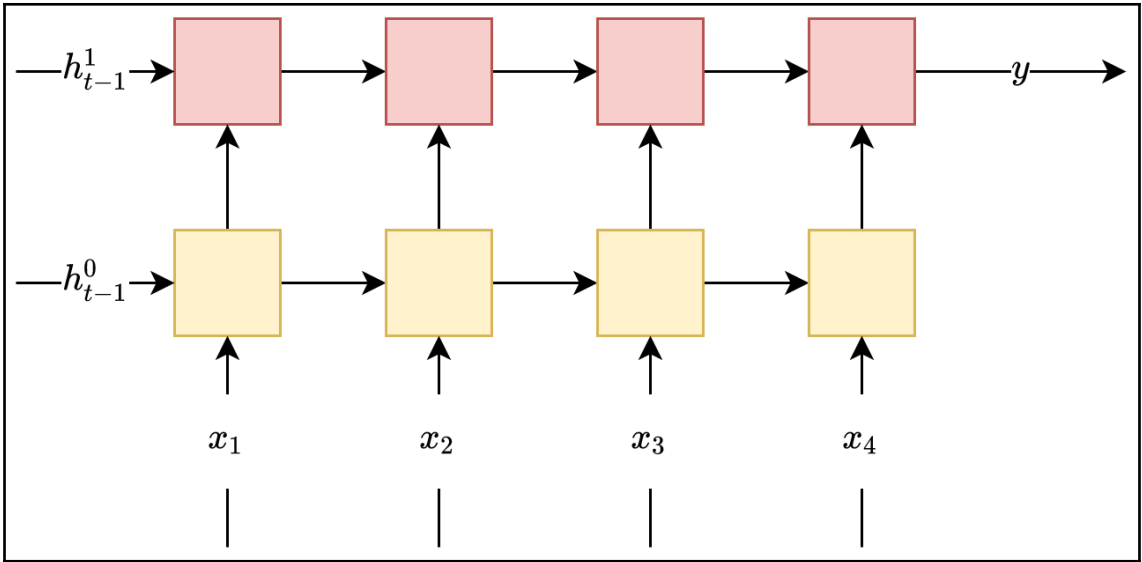

Chapter 13: Deploying Models on Mobile and Cloud Platforms

