

Chapter 1: Introducing MongoDB 4.x

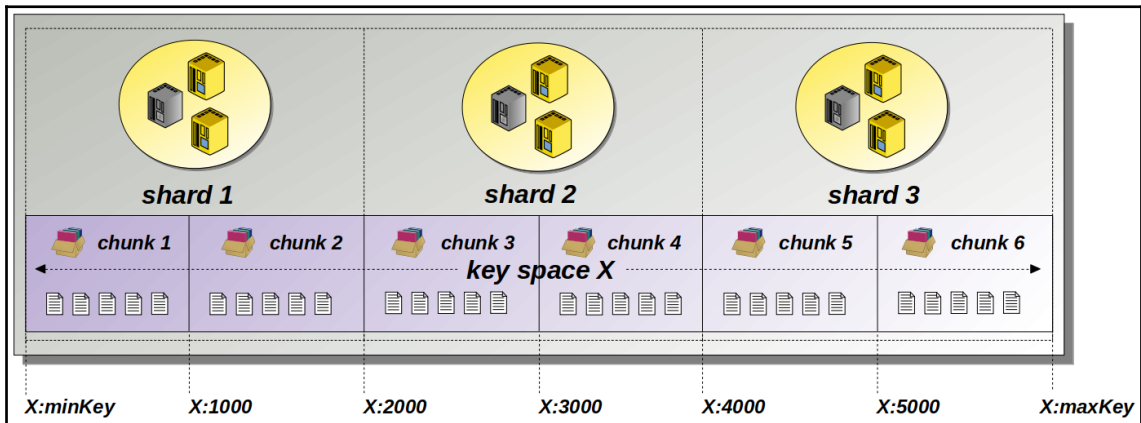
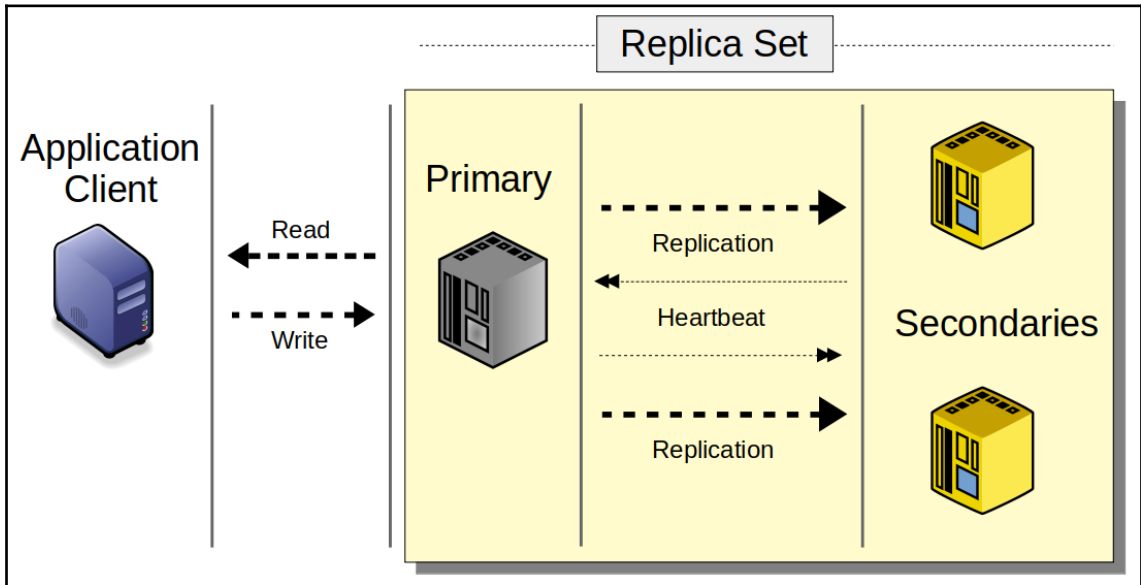

Chapter 2: Setting Up MongoDB 4.x

```
File Edit View Search Terminal Help
Configuring tzdata
-----
Please select the geographic area in which you live. Subsequent configuration questions will narrow this down by presenting a list of cities, representing the time zones in which they are located.

1. Africa 2. America 3. Antarctica 4. Australia 5. Arctic 6. Asia 7. Atlantic 8. Europe 9. Indian 10. Pacific 11. SystemV 12. US 13. Etc
Geographic area: 6

Please select the city or region corresponding to your time zone.

1. Aden 11. Baku 21. Damascus 31. Hong Kong 41. Kashgar 51. Makassar 61. Pyongyang 71. Singapore 81. Ujung Pandang
2. Almaty 12. Bangkok 22. Dhaka 32. Hovd 42. Kathmandu 52. Manila 62. Qatar 72. Srednekolymsk 82. Ulaanbaatar
3. Amman 13. Barnaul 23. Dili 33. Irkutsk 43. Khandyga 53. Muscat 63. Oostanay 73. Taipei 83. Urumqi
4. Anadyr 14. Beirut 24. Dubai 34. Istanbul 44. Kolkata 54. Nicosia 64. Qyzylorda 74. Tashkent 84. Ust-Nera
5. Aqtau 15. Bishkek 25. Dushanbe 35. Jakarta 45. Krasnoyarsk 55. Novokuznetsk 65. Rangoon 75. Tbilisi 85. Vientiane
6. Aqtobe 16. Brunei 26. Famagusta 36. Jayapura 46. Kuala Lumpur 56. Novosibirsk 66. Riyadh 76. Tehran 86. Vladivostok
7. Ashgabat 17. Chita 27. Gaza 37. Jerusalem 47. Kuching 57. Omsk 67. Sakhalin 77. Tel Aviv 87. Yakutsk
8. Atyrau 18. Choibalsan 28. Harbin 38. Kabul 48. Kuwait 58. Oral 68. Samarkand 78. Thimphu 88. Yangon
9. Baghdad 19. Chongqing 29. Hebron 39. Kamchatka 49. Macau 59. Phnom Penh 69. Seoul 79. Tokyo 89. Yekaterinburg
10. Bahrain 20. Colombo 30. Ho_Chi_Minh 40. Karachi 50. Magadan 60. Pontianak 70. Shanghai 80. Tomsk 90. Yerevan
Time zone: 12
```

```
File Edit View Search Terminal Help
root@installation1:/# apt-get install -y mongodb-org=4.4.0-rc2
Reading package lists... Done
Building dependency tree
Reading state information... Done
The following additional packages will be installed:
  krb5-locales libbrotli1 libcurl4 libgssapi-krb5-2 libk5crypto3 libkeyutils1 libkrb5-3 libkrb5support0 libnghttp2-14 librtmp1 libssh-4 mongodb-database-tools
  mongodb-org-database-tools-extra mongodb-org-mongos mongodb-org-server mongodb-org-shell mongodb-org-tools tzdata
Suggested packages:
  krb5-doc krb5-user
The following NEW packages will be installed:
  krb5-locales libbrotli1 libcurl4 libgssapi-krb5-2 libk5crypto3 libkeyutils1 libkrb5-3 libkrb5support0 libnghttp2-14 librtmp1 libssh-4 mongodb-database-tools
  mongodb-org mongodb-org-database-tools-extra mongodb-org-mongos mongodb-org-server mongodb-org-shell mongodb-org-tools tzdata
0 upgraded, 19 newly installed, 0 to remove and 0 not upgraded.
Need to get 103 MB of archives.
```

```

File Edit View Search Terminal Help
Current default time zone: 'Asia/Bangkok'
Local time is now:      Wed Apr 29 10:44:13 +07 2020.
Universal Time is now:  Wed Apr 29 03:44:13 UTC 2020.
Run 'dpkg-reconfigure tzdata' if you wish to change it.

Setting up librtmp1:amd64 (2.4+20151223.gitfa8646d.1-2build1) ...
Setting up libk5crypto3:amd64 (1.17-6ubuntu4) ...
Setting up mongodb-org-database-tools-extra (4.4.0~rc3) ...
Setting up libkrb5-3:amd64 (1.17-6ubuntu4) ...
Setting up libgssapi-krb5-2:amd64 (1.17-6ubuntu4) ...
Setting up mongodb-database-tools (100.0.1) ...
Setting up libssh-4:amd64 (0.9.3-2ubuntu2) ...
Setting up libcurl4:amd64 (7.68.0-1ubuntu2) ...
Setting up mongodb-org-server (4.4.0~rc3) ...
Adding system user `mongodb' (UID 101) ...
Adding new user `mongodb' (UID 101) with group `nogroup' ...
Not creating home directory `/home/mongodb'.
Adding group `mongodb' (GID 101) ...

```

```

File Edit View Search Terminal Help
root@installation1:~# mongo
{"t":{"$date":"2020-04-29T04:46:14.589Z"},"s":"I", "c":"NETWORK", "id":4648601,"ctx":"main","msg":"Implicit TCP FastOpen unavailable
. If TCP FastOpen is required, set tcpFastOpenServer, tcpFastOpenClient, and tcpFastOpenQueueSize."}
MongoDB shell version v4.4.0-rc3
connecting to: mongodb://127.0.0.1:27017/?compressors=disabled&gssapiServiceName=mongodb
Implicit session: session { "id" : UUID("9f0dbe07-e18f-46ff-ae4d-193bc6170139") }
MongoDB server version: 4.4.0-rc3
Welcome to the MongoDB shell.
For interactive help, type "help".
For more comprehensive documentation, see
  http://docs.mongodb.org/
Questions? Try the support group
  http://groups.google.com/group/mongodb-user
Server has startup warnings:
{"t":{"$date":"2020-04-29T04:46:11.935+00:00"},"s":"W", "c":"CONTROL", "id":22120, "ctx":"initandlisten","msg":"Access control is n
ot enabled for the database. Read and write access to data and configuration is unrestricted","tags":["startupWarnings"]}
{"t":{"$date":"2020-04-29T04:46:11.935+00:00"},"s":"W", "c":"CONTROL", "id":22138, "ctx":"initandlisten","msg":"You are running thi
s process as the root user, which is not recommended","tags":["startupWarnings"]}
---
Enable MongoDB's free cloud-based monitoring service, which will then receive and display
metrics about your deployment (disk utilization, CPU, operation statistics, etc).

The monitoring data will be available on a MongoDB website with a unique URL accessible to you
and anyone you share the URL with. MongoDB may use this information to make product
improvements and to suggest MongoDB products and deployment options to you.

To enable free monitoring, run the following command: db.enableFreeMonitoring()
To permanently disable this reminder, run the following command: db.disableFreeMonitoring()
---
>

```

The screenshot shows the GitHub interface for the repository 'PacktPublishing / Learn-MongoDB-4.x'. At the top, there are navigation tabs for Code, Issues, Pull requests, Actions, Wiki, Security, and Insights. Below the repository name, it shows the current branch as 'master', with 1 branch and 0 tags. A 'Code' dropdown menu is open, showing options to 'Clone with HTTPS', 'Use SSH', and 'Download ZIP'. The 'Clone with HTTPS' option is selected, displaying the URL 'https://github.com/PacktPublishing/'. Below the repository name, there is a list of files and folders with their last update dates:

File/Folder	Last Update
dbierer	2020-08-02 DB: updated examples for chapter 3
chapters	2020-08-02 DB: updated
docker	2020-08-02 DB: updated
sample_data	2020-08-02 DB: updated

```
ned@ned: ~/Repos
ned@ned:~/Repos$ git clone https://github.com/PacktPublishing/Learn-MongoDB-4.x.git
Cloning into 'Learn-MongoDB-4.x'...
remote: Enumerating objects: 95, done.
remote: Counting objects: 100% (95/95), done.
remote: Compressing objects: 100% (68/68), done.
remote: Total 1265 (delta 16), reused 73 (delta 14), pack-reused 1170
Receiving objects: 100% (1265/1265), 9.77 MiB | 2.06 MiB/s, done.
Resolving deltas: 100% (560/560), done.
ned@ned:~/Repos$
```

```
File Edit View Search Terminal Help
jed@jed:~$ docker exec -it learn-mongo-server-1 /bin/bash
root@server1:/# cd /repo/chapters/02
root@server1:/repo/chapters/02# python3 test_connection.py

Insert Result:
<pymongo.results.InsertOneResult object at 0x7f73da6923c8>

Find Result:
{'_id': ObjectId('5e9d2e8462d17942c4a1cbfe'),
 'first_name': 'Fred',
 'last_name': 'Flintstone'}
root@server1:/repo/chapters/02#
```

```
File Edit View Search Terminal Help
jed@jed:~/Repos/learn-mongodb$ ping -c3 learning.mongoddb.local
PING learning.mongoddb.local (172.16.0.11) 56(84) bytes of data.
64 bytes from learning.mongoddb.local (172.16.0.11): icmp_seq=1 ttl=64 time=0.159 ms
64 bytes from learning.mongoddb.local (172.16.0.11): icmp_seq=2 ttl=64 time=0.173 ms
64 bytes from learning.mongoddb.local (172.16.0.11): icmp_seq=3 ttl=64 time=0.144 ms

--- learning.mongoddb.local ping statistics ---
3 packets transmitted, 3 received, 0% packet loss, time 2046ms
rtt min/avg/max/mdev = 0.144/0.158/0.173/0.018 ms
jed@jed:~/Repos/learn-mongodb$
```

Chapter 3: Essential MongoDB Administration Techniques

```
root@server1: /
MongoDB shell version v4.4.0-rc12
connecting to: mongodb://127.0.0.1:27017/?compressors=disabled&gssapiServiceName=mongodb
Implicit session: session { "id" : UUID("1e9819e8-0f20-4ce9-bddd-8bc51ef18b25") }
MongoDB server version: 4.4.0-rc12
Welcome to the MongoDB shell.
For interactive help, type "help".
For more comprehensive documentation, see
  https://docs.mongodb.com/
Questions? Try the MongoDB Developer Community Forums
  https://community.mongodb.com
---
The server generated these startup warnings when booting:
  2020-07-08T10:12:21.909+00:00: Using the XFS filesystem is strongly recommended with the Wired
Tiger storage engine. See http://dochub.mongodb.org/core/prodnotes-filesystem
  2020-07-08T10:12:22.498+00:00: Access control is not enabled for the database. Read and write
access to data and configuration is unrestricted
  2020-07-08T10:12:22.498+00:00: You are running this process as the root user, which is not rec
ommended
---
---
  Enable MongoDB's free cloud-based monitoring service, which will then receive and display
metrics about your deployment (disk utilization, CPU, operation statistics, etc).

  The monitoring data will be available on a MongoDB website with a unique URL accessible to you
and anyone you share the URL with. MongoDB may use this information to make product
improvements and to suggest MongoDB products and deployment options to you.

  To enable free monitoring, run the following command: db.enableFreeMonitoring()
  To permanently disable this reminder, run the following command: db.disableFreeMonitoring()
---
>
```

```
root@server1: ~
root@server1:~# mongo --quiet
MongoDB server1@test[up:769 secs]
1>
```

```
root@server1: /repo
MongoDB server1@test[up:1078 secs]
1>show dbs;
admin    0.000GB
config  0.000GB
local   0.000GB

MongoDB server1@test[up:1080 secs]
2>use admin;
switched to db admin

MongoDB server1@admin[up:1090 secs]
3>show collections;
system.version

MongoDB server1@admin[up:1093 secs]
4>
```

```
root@server1: ~
root@server1:~# mongo /repo/sample_data/sweetscomplete_customers_insert.js
MongoDB shell version v4.4.0-rc12
connecting to: mongodb://127.0.0.1:27017/?compressors=disabled&gssapiServiceName=mongodb
Implicit session: session { "id" : UUID("293c769f-4672-4ffc-af7a-a97972283109") }
MongoDB server version: 4.4.0-rc12
root@server1:~#
```



```
root@server1: ~
root@server1:~# mongo --quiet

MongoDB server1@test[up:700 secs]
1>use sweetscomplete;
switched to db sweetscomplete

MongoDB server1@sweetscomplete[up:704 secs]
2>show collections;
customers

MongoDB server1@sweetscomplete[up:707 secs]
3>load("/repo/sample_data/sweetscomplete_products_insert.js");
true

MongoDB server1@sweetscomplete[up:723 secs]
4>show collections;
customers
products

MongoDB server1@sweetscomplete[up:726 secs]
5>
```

```
db.<collection_name>.insertOne(
```

```
{  
  "field1" : "<value>",  
  "field2" : "<value>",  
  etc.  
}
```

DOCUMENT

```
);
```

```
File Edit View Search Terminal Help
```

```
MongoDB server1@learn[up:61489 secs]
```

```
43>db.chapters.insertOne(
```

```
... {  
...   "chapterNumber" : 3,  
...   "chapterName"   : "Essential MongoDB Administration Techniques"  
... }));
```

```
{  
  "acknowledged" : true,  
  "insertedId"   : ObjectId("5eab85d4793bb6b9f3d26447")  
}
```

```
MongoDB server1@learn[up:61505 secs]
```

```
44>
```

```
db.<collection_name>.find(
```

```
{“field” : “<value>”}
```

```
-----  
{“field” : {“$op” : “<value>”}}
```

QUERY,

```
{“field” : 0 | 1}
```

PROJECTION

```
);
```

```
File Edit View Search Terminal Help
MongoDB server1@sweetscomplete[up:336 secs]
3>db.customers.findOne({"phoneNumber":/44-118-652-0519/});
{
  "_id" : ObjectId("5eaa96cfcbab62398c8a7266"),
  "customerKey" : "REANMCCA0519",
  "firstName" : "Reanna",
  "lastName" : "Mccarthy",
  "phoneNumber" : "+44-118-652-0519",
  "email" : "rmccarth118@Telecom.com",
  "streetAddressOfBuilding" : "304 Blue Mountain Avenue",
  "buildingName" : null,
  "floor" : null,
  "roomApartmentCondoNumber" : null,
  "city" : "Newby",
  "stateProvince" : "England",
  "locality" : "Cumbria",
  "country" : "GB",
  "postalCode" : "CA10",
  "latitude" : "54.5843",
  "longitude" : "-2.6369",
  "username" : "rmccarth",
  "password" : "$2y$10$jV40Qd6LGwG5Jf5YqUFd.IodwGyG/q7pWAJgpRfsx5qdfIqfGxRS",
  "secondaryPhoneNumbers" : [
    "+44-329-910-7898"
  ],
  "secondaryEmailAddresses" : [
    "rmccarth@CUBENet.net"
  ],
  "socialMedia" : [ ],
  "gender" : "F",
  "dateOfBirth" : "1955-03-09"
}
MongoDB server1@sweetscomplete[up:366 secs]
4>
```

```
File Edit View Search Terminal Help
MongoDB server1@sweetscomplete[up:460 secs]
5>db.customers.find().count();
286

MongoDB server1@sweetscomplete[up:466 secs]
6>
```

```
File Edit View Search Terminal Help
MongoDB server1@sweetscomplete[up:656 secs]
7>db.customers.find(
... {
...   "$and" : [
...     {"country" : { "$nin": maj_english }},
...     {"dateOfBirth" : {"$lt":"1968-01-01"}}
...   ]
... }).count();
76

MongoDB server1@sweetscomplete[up:675 secs]
8>
```

```
File Edit View Search Terminal Help
MongoDB server1@sweetscomplete[up:1004 secs]
16>db.customers.find(query,projection).pretty();
{
  "firstName" : "Dominick",
  "lastName"  : "Lester",
  "email"     : "dlester124@KDDI.com",
  "stateProvince" : "QC",
  "country"   : "CA"
}
{
  "firstName" : "Darryl",
  "lastName"  : "Wilkinson",
  "email"     : "dwilkins130@Unicom.com",
  "stateProvince" : "QC",
  "country"   : "CA"
}
```

```
db.<collection_name>.updateOne(
```

```
  {"field" : "<value>"}
```

FILTER,

```
  -----  
  {"field" : {"$op" : "<value>"}}
```

```
  {"field1" : "xxx", "field2" : "yyy" }
```

UPDATE,

```
  { upsert : true |false, etc. }
```

OPTIONS

```
);
```

```
File Edit View Search Terminal Help  
MongoDB server1@sweetscomplete[up:1275 secs]  
21>db.customers.updateOne(  
...   {"email" : "omann137@Chunghwa.com"},  
...   { $set: {  
...     "email" : "ola.mann22@somenet.com",  
...     "phoneNumber" : "+94-111-222-3333" }  
...   }  
... );  
{ "acknowledged" : true, "matchedCount" : 1, "modifiedCount" : 1 }  
  
MongoDB server1@sweetscomplete[up:1277 secs]  
22>
```

```
File Edit View Search Terminal Help
MongoDB server1@sweetscomplete[up:1277 secs]
22>db.customers.find({"buildingName":{"$type":"null"}},{"customerKey":1,"buildingName":1});
{ "_id" : ObjectId("5eaa96cfcbab62398c8a7254"), "customerKey" : "PATRYODE9823", "buildingName" : null }
{ "_id" : ObjectId("5eaa96cfcbab62398c8a7255"), "customerKey" : "ALTASANT6271", "buildingName" : null }
{ "_id" : ObjectId("5eaa96cfcbab62398c8a7256"), "customerKey" : "MARLDORS7479", "buildingName" : null }
{ "_id" : ObjectId("5eaa96cfcbab62398c8a7257"), "customerKey" : "WMMORE0896", "buildingName" : null }
{ "_id" : ObjectId("5eaa96cfcbab62398c8a7258"), "customerKey" : "CORICAST5104", "buildingName" : null }
{ "_id" : ObjectId("5eaa96cfcbab62398c8a7259"), "customerKey" : "JULIOROZ8091", "buildingName" : null }
{ "_id" : ObjectId("5eaa96cfcbab62398c8a725a"), "customerKey" : "GENEMYER4370", "buildingName" : null }
{ "_id" : ObjectId("5eaa96cfcbab62398c8a725b"), "customerKey" : "LIBEBRAN9462", "buildingName" : null }
{ "_id" : ObjectId("5eaa96cfcbab62398c8a725c"), "customerKey" : "DAVIHOWE0711", "buildingName" : null }
{ "_id" : ObjectId("5eaa96cfcbab62398c8a725d"), "customerKey" : "REGIIBAR8447", "buildingName" : null }
{ "_id" : ObjectId("5eaa96cfcbab62398c8a725e"), "customerKey" : "KYLESELL3321", "buildingName" : null }
{ "_id" : ObjectId("5eaa96cfcbab62398c8a7260"), "customerKey" : "IKEADAM7878", "buildingName" : null }
{ "_id" : ObjectId("5eaa96cfcbab62398c8a7261"), "customerKey" : "AUREBRAN7182", "buildingName" : null }
{ "_id" : ObjectId("5eaa96cfcbab62398c8a7262"), "customerKey" : "BIANLIND8466", "buildingName" : null }
{ "_id" : ObjectId("5eaa96cfcbab62398c8a7263"), "customerKey" : "FERMZAVA5969", "buildingName" : null }
{ "_id" : ObjectId("5eaa96cfcbab62398c8a7264"), "customerKey" : "GLENMCLA8639", "buildingName" : null }
{ "_id" : ObjectId("5eaa96cfcbab62398c8a7265"), "customerKey" : "PIERCARE0110", "buildingName" : null }
{ "_id" : ObjectId("5eaa96cfcbab62398c8a7266"), "customerKey" : "REANMCCA0519", "buildingName" : null }
{ "_id" : ObjectId("5eaa96cfcbab62398c8a7267"), "customerKey" : "TIJUHOGA5010", "buildingName" : null }
{ "_id" : ObjectId("5eaa96cfcbab62398c8a7268"), "customerKey" : "ELVASALA6803", "buildingName" : null }
Type "it" for more

MongoDB server1@sweetscomplete[up:1365 secs]
23>
```



```
File Edit View Search Terminal Help

MongoDB server1@sweetscomplete[up:60331 secs]
30>key = "PATRYODE9823"
PATRYODE9823

MongoDB server1@sweetscomplete[up:60335 secs]
31>db.customers.updateOne(
...     {"buildingName":{"$type":"null"},"customerKey":key},
...     {"$set":{"buildingName":""}}
... );
{ "acknowledged" : true, "matchedCount" : 0, "modifiedCount" : 0 }

MongoDB server1@sweetscomplete[up:60339 secs]
32>db.customers.findOne(
...     {"buildingName":{"$type":"null"},"customerKey":key},
...     {"customerKey":1,"buildingName":1}
... );
null

MongoDB server1@sweetscomplete[up:60345 secs]
33>
```

```
File Edit View Search Terminal Help

MongoDB server1@sweetscomplete[up:60659 secs]
34>db.customers.find({"buildingName":{"$type":"null"}}).count();
261

MongoDB server1@sweetscomplete[up:60660 secs]
35>db.customers.updateMany({"buildingName":{"$type":"null"}},{"$set":{"buildingName":""}});
{ "acknowledged" : true, "matchedCount" : 261, "modifiedCount" : 261 }

MongoDB server1@sweetscomplete[up:60668 secs]
36>db.customers.find({"buildingName":{"$type":"null"}}).count();
0

MongoDB server1@sweetscomplete[up:60673 secs]
37>
```

db.<collection_name>.deleteOne(

{ "field" : "<value>" }

FILTER,

{ "field" : { "\$op" : "<value>" } }

{ writeConcern : { xxx }, etc. }

OPTIONS

);

```
File Edit View Search Terminal Help
MongoDB server1@learn[up:62140 secs]
l0>use learn;
switched to db learn

MongoDB server1@learn[up:62142 secs]
l1>load("/repo/sample_data/learn_insert.js");
true

MongoDB server1@learn[up:62144 secs]
l2>db.chapters.find();
{ "_id" : ObjectId("5eab8854afd2a9edf3e26414"), "chapterNumber" : 3, "chapterName" : "Essential MongoDB Administration Techniques" }
{ "_id" : ObjectId("5eab8854afd2a9edf3e26415"), "chapterNumber" : 1, "chapterName" : "Introducing MongoDB 4.x" }
{ "_id" : ObjectId("5eab8854afd2a9edf3e26416"), "chapterNumber" : 2, "chapterName" : "Setting up MongoDB 4.x Draft complete" }
{ "_id" : ObjectId("5eab8854afd2a9edf3e26417"), "chapterNumber" : 3, "chapterName" : "Essential MongoDB Administration Techniques Draft" }
{ "_id" : ObjectId("5eab8854afd2a9edf3e26418"), "chapterNumber" : 4, "chapterName" : "Fundamentals of Database Design Draft" }
{ "_id" : ObjectId("5eab8854afd2a9edf3e26419"), "chapterNumber" : 5, "chapterName" : "Mission Critical MongoDB Database Tasks Draft" }
{ "_id" : ObjectId("5eab8854afd2a9edf3e2641a"), "chapterNumber" : 6, "chapterName" : "Using AJAX and REST to Build a Database Driven Website Draft" }
{ "_id" : ObjectId("5eab8854afd2a9edf3e2641b"), "chapterNumber" : 7, "chapterName" : "Advanced MongoDB Database Design Draft" }
{ "_id" : ObjectId("5eab8854afd2a9edf3e2641c"), "chapterNumber" : 8, "chapterName" : "Using Documents with Embedded Lists and Objects Draft" }
{ "_id" : ObjectId("5eab8854afd2a9edf3e2641d"), "chapterNumber" : 9, "chapterName" : "Handling Complex Queries in MongoDB Draft" }
{ "_id" : ObjectId("5eab8854afd2a9edf3e2641e"), "chapterNumber" : 10, "chapterName" : "Working with Complex Documents Across Collections Draft" }
{ "_id" : ObjectId("5eab8854afd2a9edf3e2641f"), "chapterNumber" : 11, "chapterName" : "Administering MongoDB Security Draft" }
{ "_id" : ObjectId("5eab8854afd2a9edf3e26420"), "chapterNumber" : 12, "chapterName" : "Developing in a Secured Environment Draft" }
{ "_id" : ObjectId("5eab8854afd2a9edf3e26421"), "chapterNumber" : 13, "chapterName" : "Deploying a Replica Set Draft complete" }
{ "_id" : ObjectId("5eab8854afd2a9edf3e26422"), "chapterNumber" : 14, "chapterName" : "Deploying a Sharded Cluster" }

MongoDB server1@learn[up:62151 secs]
l3>
```

```
File Edit View Search Terminal Help
14>db.chapters.find({"chapterNumber":3});
{ "_id" : ObjectId("5eab8854afd2a9edf3e26414"), "chapterNumber" : 3, "chapterName" :
  "Essential MongoDB Administration Techniques" }
{ "_id" : ObjectId("5eab8854afd2a9edf3e26417"), "chapterNumber" : 3, "chapterName" :
  "Essential MongoDB Administration Techniques Draft" }

MongoDB server1@learn[up:62403 secs]
15>db.chapters.deleteOne({"_id":"5eab8854afd2a9edf3e26414"});
{ "acknowledged" : true, "deletedCount" : 0 }

MongoDB server1@learn[up:62455 secs]
16>db.chapters.find({"chapterNumber":3});
{ "_id" : ObjectId("5eab8854afd2a9edf3e26414"), "chapterNumber" : 3, "chapterName" :
  "Essential MongoDB Administration Techniques" }
{ "_id" : ObjectId("5eab8854afd2a9edf3e26417"), "chapterNumber" : 3, "chapterName" :
  "Essential MongoDB Administration Techniques Draft" }

MongoDB server1@learn[up:62463 secs]
17>
```

```
File Edit View Search Terminal Help
MongoDB server1@learn[up:62841 secs]
18>db.chapters.deleteOne({"_id":ObjectId("5eab8854afd2a9edf3e26414")});
{ "acknowledged" : true, "deletedCount" : 1 }

MongoDB server1@learn[up:62855 secs]
19>db.chapters.find({"chapterNumber":3});
{ "_id" : ObjectId("5eab8854afd2a9edf3e26417"), "chapterNumber" : 3, "chapterName" :
  "Essential MongoDB Administration Techniques Draft" }

MongoDB server1@learn[up:62857 secs]
20>
```

```
root@server1: ~  
root@server1:~# mongodump --db=sweetscomplete --verbose=2 --out=/root/backup  
2020-07-08T10:49:55.739+0000 will listen for SIGTERM, SIGINT, and SIGKILL  
2020-07-08T10:49:55.746+0000 enqueued collection 'sweetscomplete.customers'  
2020-07-08T10:49:55.746+0000 enqueued collection 'sweetscomplete.common'  
2020-07-08T10:49:55.746+0000 enqueued collection 'sweetscomplete.products'  
2020-07-08T10:49:55.747+0000 enqueued collection 'sweetscomplete.purchases'  
2020-07-08T10:49:55.747+0000 dumping up to 4 collections in parallel  
2020-07-08T10:49:55.748+0000 writing sweetscomplete.common to /root/backup/sweetscomplete/common.bson  
2020-07-08T10:49:55.748+0000 writing sweetscomplete.customers to /root/backup/sweetscomplete/customers.bson  
2020-07-08T10:49:55.749+0000 counted 4 documents in sweetscomplete.common  
2020-07-08T10:49:55.749+0000 counted 286 documents in sweetscomplete.customers  
2020-07-08T10:49:55.749+0000 writing sweetscomplete.products to /root/backup/sweetscomplete/products.bson  
2020-07-08T10:49:55.749+0000 done dumping sweetscomplete.common (4 documents)  
2020-07-08T10:49:55.752+0000 counted 26 documents in sweetscomplete.products  
2020-07-08T10:49:55.750+0000 writing sweetscomplete.purchases to /root/backup/sweetscomplete/purchases.bson  
2020-07-08T10:49:55.750+0000 counted 496 documents in sweetscomplete.purchases  
2020-07-08T10:49:55.752+0000 done dumping sweetscomplete.customers (286 documents)  
2020-07-08T10:49:55.753+0000 done dumping sweetscomplete.products (26 documents)  
2020-07-08T10:49:55.754+0000 done dumping sweetscomplete.purchases (496 documents)  
2020-07-08T10:49:55.754+0000 dump phase III: the oplog  
2020-07-08T10:49:55.754+0000 finishing dump  
root@server1:~#
```

```
root@server1: ~  
root@server1:~# mongorestore --db=sweetscomplete --collection=purchases --drop --objcheck --verbose=2 --dir=/root/backup/sweetscomplete/purchases.bson  
2020-07-08T10:52:48.008+0000 using --dir flag instead of arguments  
2020-07-08T10:52:48.008+0000 using write concern: &{majority false 0}  
2020-07-08T10:52:48.010+0000 will listen for SIGTERM, SIGINT, and SIGKILL  
2020-07-08T10:52:48.010+0000 connected to node type: standalone  
2020-07-08T10:52:48.010+0000 mongorestore target is a file, not a directory  
2020-07-08T10:52:48.010+0000 checking for collection data in /root/backup/sweetscomplete/purchases.bson  
2020-07-08T10:52:48.010+0000 reading collection purchases for database sweetscomplete from /root/backup/sweetscomplete/purchases.bson  
2020-07-08T10:52:48.010+0000 scanning directory &{0xc00025c750 /root/backup <nil>} for metadata  
2020-07-08T10:52:48.011+0000 found metadata for collection at /root/backup/sweetscomplete/purchases.metadata.json  
2020-07-08T10:52:48.011+0000 enqueued collection 'sweetscomplete.purchases'  
2020-07-08T10:52:48.011+0000 restoring up to 4 collections in parallel  
2020-07-08T10:52:48.011+0000 dropping collection sweetscomplete.purchases before restoring  
2020-07-08T10:52:48.017+0000 reading metadata for sweetscomplete.purchases from /root/backup/sweetscomplete/purchases.metadata.json  
2020-07-08T10:52:48.018+0000 creating collection sweetscomplete.purchases using options from metadata  
2020-07-08T10:52:48.025+0000 restoring sweetscomplete.purchases from /root/backup/sweetscomplete/purchases.bson  
2020-07-08T10:52:48.025+0000 using 4 insertion workers  
2020-07-08T10:52:48.086+0000 no indexes to restore  
2020-07-08T10:52:48.086+0000 finished restoring sweetscomplete.purchases (496 documents, 0 failures)  
2020-07-08T10:52:48.086+0000 496 document(s) restored successfully. 0 document(s) failed to restore.  
root@server1:~#
```

```
root@server1: ~  
root@server1:~# mongorestore --nsInclude sweetscomplete.products --dir=/root/backup/  
2020-07-08T10:58:44.055+0000 preparing collections to restore from  
2020-07-08T10:58:44.055+0000 reading metadata for sweetscomplete.products from /root/backup/sweetscomplete/products.metadata.json  
2020-07-08T10:58:44.063+0000 restoring sweetscomplete.products from /root/backup/sweetscomplete/products.bson  
2020-07-08T10:58:44.069+0000 no indexes to restore  
2020-07-08T10:58:44.070+0000 finished restoring sweetscomplete.products (26 documents, 0 failures)  
2020-07-08T10:58:44.070+0000 26 document(s) restored successfully. 0 document(s) failed to restore.  
root@server1:~#
```

```
File Edit View Search Terminal Help
22>use sweetscomplete;
switched to db sweetscomplete

MongoDB server1@sweetscomplete[up:64070 secs]
23>db.stats();
{
  "db" : "sweetscomplete",
  "collections" : 4,
  "views" : 0,
  "objects" : 812,
  "avgObjSize" : 2379.729064039409,
  "dataSize" : 1932340,
  "storageSize" : 1662976,
  "numExtents" : 0,
  "indexes" : 4,
  "indexSize" : 81920,
  "scaleFactor" : 1,
  "fsUsedSize" : 127877709824,
  "fsTotalSize" : 244529655808,
  "ok" : 1
}

MongoDB server1@sweetscomplete[up:64073 secs]
24>
```

```
File Edit View Search Terminal Help
MongoDB server1@sweetscomplete[up:68203 secs]
4>db.serverStatus();
{
  "host" : "server1",
  "version" : "4.2.6",
  "process" : "mongod",
  "pid" : NumberLong(1),
  "uptime" : 68207,
  "uptimeMillis" : NumberLong(68206849),
  "uptimeEstimate" : NumberLong(68206),
  "localTime" : ISODate("2020-05-01T04:05:23.492Z"),
  "asserts" : {
    "regular" : 0,
    "warning" : 0,
    "msg" : 0,
    "user" : 15,
    "rollovers" : 0
  },
  "connections" : {
    "current" : 1,
    "available" : 838859,
    "totalCreated" : 19,
    "active" : 1
  },
  "electionMetrics" : {
```

Chapter 4: Fundamentals of Database Design



```
File Edit View Search Terminal Help
Product Entity Initialized from Dictionary
Title: Test
Category: test
{"productKey": "TEST20190307", "productPhoto": "TEST", "skuNumber": "TEST0000",
"category": "test", "title": "Test", "description": "test", "price": 2.22, "unit
": "test", "costPerUnit": 1.11, "unitsOnHand": 333}

-----
(program exited with code: 0)
Press return to continue
```

```
File Edit View Search Terminal Help
..
-----
Ran 2 tests in 0.000s

OK
-----
(program exited with code: 0)
Press return to continue
█
```

Chapter 5: Mission-Critical MongoDB Database Tasks

```
File Edit View Search Terminal Help
Result from Query:
Class:    <class 'sweetscomplete.entity.product.Product'>
Key:     apple_pie
Title:   Apple Pie
Category: pie
JSON:    {"_id": "5c80b6c2d5e85963e1714dc9", "productKey": "apple_pie", "skuNumber": "APPL501", "category": "pie", "title": "Apple Pie", "description": "Cras sit amet eros congue, rhoncus sem sed, consequat arcu. Nam gravida libero ac male suada cursus. Ut quis massa sit amet enim faucibus suscipit ac viverra elit.", "price": "4.99", "unit": "tin", "costPerUnit": 4.4910000000000005, "unitsOnHand": 736.0}

-----
(program exited with code: 0)
Press return to continue
```

```
File Edit View Search Terminal Help
```

```
Adding a Single Test Product
```

```
Product test20190313 added successfully
```

```
Fetch Product by Key
```

```
{"_id": "5c88ba970317e31daf50e5e3", "productKey": "test20190313", "productPhoto": "TEST", "skuNumber": "TEST0000", "category": "test", "title": "Test", "description": "test", "price": "1.11", "unit": "test", "costPerUnit": "2.22", "unitsOnHand": 333}
```

```
Product test20190313 deleted successfully
```

```
List of Product Titles and Keys
```

```
Apple Pie [apple_pie]
```

```
Birthday Cake [birthday_cake]
```

```
Black And Tan Truffel [black_and_tan_truffel]
```

```
Cake With Chocolate Frosting [cake_with_chocolate_frosting]
```

```
Carrot Cake [carrot_cake]
```

```
Cherry Pie [cherry_pie]
```

```
-----  
(program exited with code: 0)
```

```
Press return to continue
```

```
█
```

```

File Edit View Search Terminal Help
> query = {"dateOfPurchase":{"$regex":/^2018/}};
{ "dateOfPurchase" : { "$regex" : /^2018/ } }
> projection = {"dateOfPurchase":1,"extendedPrice":1,"country":1,"_id":0};
{ "dateOfPurchase" : 1, "extendedPrice" : 1, "country" : 1, "_id" : 0 }
> db.purchases.find(query, projection).sort({"country":1,"dateOfPurchase":1});
{ "dateOfPurchase" : "2018-02-05 11:48:08", "extendedPrice" : 691.89, "country" : "AD" }
{ "dateOfPurchase" : "2018-01-24 11:48:08", "extendedPrice" : 47645.450000000004, "country" : "AU" }
{ "dateOfPurchase" : "2018-02-22 11:48:08", "extendedPrice" : 35914.950000000004, "country" : "AU" }
{ "dateOfPurchase" : "2018-03-07 11:48:08", "extendedPrice" : 3818.7400000000002, "country" : "AU" }
{ "dateOfPurchase" : "2018-06-15 11:48:07", "extendedPrice" : 7982.530000000001, "country" : "AU" }
{ "dateOfPurchase" : "2018-07-25 11:48:08", "extendedPrice" : 12594.65, "country" : "AU" }
{ "dateOfPurchase" : "2018-08-09 11:48:07", "extendedPrice" : 3213.56, "country" : "AU" }
{ "dateOfPurchase" : "2018-10-07 11:48:08", "extendedPrice" : 5690.9400000000005, "country" : "AU" }
{ "dateOfPurchase" : "2018-10-31 11:48:08", "extendedPrice" : 7601.73, "country" : "AU" }
{ "dateOfPurchase" : "2018-11-13 11:48:08", "extendedPrice" : 1157.13, "country" : "AU" }
{ "dateOfPurchase" : "2018-11-18 11:48:08", "extendedPrice" : 3603.5200000000004, "country" : "AU" }
{ "dateOfPurchase" : "2018-11-21 11:48:07", "extendedPrice" : 11762.3, "country" : "AU" }
{ "dateOfPurchase" : "2018-11-29 11:48:08", "extendedPrice" : 6029.0599999999995, "country" : "AU" }
{ "dateOfPurchase" : "2018-12-03 11:48:08", "extendedPrice" : 15239.01, "country" : "AU" }
{ "dateOfPurchase" : "2018-04-04 11:48:08", "extendedPrice" : 9981.17, "country" : "BD" }
{ "dateOfPurchase" : "2018-08-25 11:48:07", "extendedPrice" : 3769.5600000000004, "country" : "BD" }
{ "dateOfPurchase" : "2018-07-09 11:48:08", "extendedPrice" : 11117.289999999999, "country" : "BM" }
{ "dateOfPurchase" : "2018-07-21 11:48:08", "extendedPrice" : 10638.38, "country" : "BM" }
{ "dateOfPurchase" : "2018-08-30 11:48:07", "extendedPrice" : 59.85, "country" : "BM" }
{ "dateOfPurchase" : "2018-01-21 11:48:08", "extendedPrice" : 2935.09, "country" : "CA" }
Type "it" for more
>

```

```
File Edit View Search Terminal Help
Country: US
      Month   Sales
      03     26114.05
      04     53782.79
      05       6503.68
      07        396.41
      08       5243.23
      09     12421.02
      12     52464.39

Country: UY
      Month   Sales
      08     14032.52

Country: YT
      Month   Sales
      06     10025.22

Grand Total:      1362568.95

-----
(program exited with code: 0)
Press return to continue
█
```

```
File Edit View Search Terminal Help
Adding a Single Test Product

Product test20190313 added successfully

Fetch Product by Key
{"_id": "5c88c5ef0317e321c5f5f057", "productKey": "test20190313", "productPhoto"
: "TEST", "skuNumber": "TEST0000", "category": "test", "title": "Test", "descrip
tion": "test", "price": 1.11, "unit": "test", "costPerUnit": 2.22, "unitsOnHand"
: 333}

Product test20190313 updated successfully

{"_id": "5c88c5ef0317e321c5f5f057", "productKey": "test20190313", "productPhoto"
: "REVISED PHOTO", "skuNumber": "TEST0000", "category": "test", "title": "Test",
"description": "test", "price": 2.22, "unit": "test", "costPerUnit": 2.22, "uni
tsOnHand": 333}

Product test20190313 deleted successfully

-----
(program exited with code: 0)
Press return to continue
```

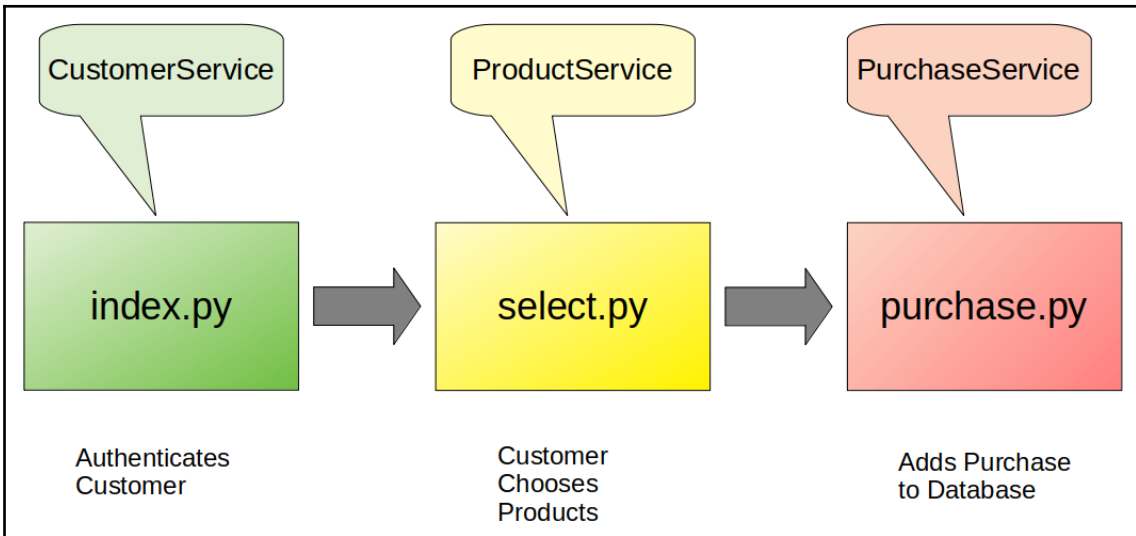

TYPE CLOUD: Edit Post <Lea X Chap 5: Index x +

learning.mongodb.local/chapter_05/index.py 120% Search

Simple Login

[PRODUCTS](#)

Email Address:

Password:

Please Login Before Purchase

```
File Edit View Search Terminal Help
root@server1:/# ls -l /repo/www/data
total 4
-rw-r--r-- 1 www-data www-data 27 May  4 04:54 5cd00efc47474e01b029ea9aac6255f6.sess
root@server1:/# cat /repo/www/data/5cd00efc47474e01b029ea9aac6255f6.sess
{"custKey": "KURTHESS8667"}root@server1:/#
root@server1:/#
```

TYPE CLOUD: Edit Post < Lea x Chap 5: Select x +

learning.mongoddb.local/chapter_05/select.py 120% Search

Welcome to Sweets Complete

You are logged in as: Kurt Hess

[LOGIN](#)

Choose Product(s) to Purchase:

Birthday Cake [\$9.99]	Quantity: 1
Cherry Pie [\$4.99]	Quantity: 2
Chocolate Bunny [\$6.49]	Quantity: 3
Apple Pie [\$4.99]	Quantity: 0
Apple Pie [\$4.99]	Quantity: 0
Apple Pie [\$4.99]	Quantity: 0

Purchase

TYPE CLOUD: Edit Post < Lea x Chap 5: Purchase x +

learning.mongodb.local/chapter_05/purchase.py 120% Search

Welcome to Sweets Complete

You are logged in as: Kurt Hess

[SELECT](#)

Here is a your most recent purchase:

Purchase Info

Date 2019-03-26 11:21:43
Total 39.44

Product(s)

<i>Title</i>	<i>Quantity</i>	<i>Price</i>
Birthday Cake	1	9.99
Cherry Pie	2	4.99
Chocolate Bunny	3	6.49

Thanks for your purchase!

Cancel

Purchase cancelled.

Chapter 6: Using AJAX and REST to Build a Database-Driven Website

Welcome to Sweets Complete

You are logged in as: Yadira Conway

[LOGIN](#) | [SELECT](#) | [RECENT](#)

Purchase History

Date	Total	Products	<i>Qty</i>	<i>Price</i>
2019-05-08 11:48:07	1236.57	<i>Title</i> Chocolate Chip Cookie Star And Sprinkles Donut	51 403	0.88 0.59
2017-12-03 11:48:07	4054.61	<i>Title</i> Layer Cake Birthday Cake	190 349	2.99 9.99
2017-02-20 11:48:07	1484.24	<i>Title</i> Cherry Pie Peanut Truffle	231 95	4.99 3.49
2019-01-22 11:48:08	28191.86	<i>Title</i> Cake With Chocolate Frosting Chocolate Bunny Apple Pie Dozen Donuts	984 918 536 379	8.99 6.49 4.99 6.99

[Previous](#) | 0 | [Next](#)

You are currently viewing page: 0

Welcome to Sweets Complete

You are logged in as: Yadira Conway

[LOGIN](#) | [SELECT](#) | [RECENT](#)

Purchase History

Date	Total	Products	Qty	Price
2018-10-05 11:48:08	849.41	<i>Title</i> Star And Sprinkles Donut Chocolate Bar	492 187	0.59 2.99
2019-03-16 11:48:08	1279.66	<i>Title</i> Chocolate Chip Cookie Carrot Cake	637 90	0.88 7.99
2018-11-06 11:48:08	4852.28	<i>Title</i> Schweineohrchen Cookie Pumpkin Pie Star And Sprinkles Donut	701 789 317	0.49 4.99 0.59

[Previous](#) | 1 | [Next](#)

You are currently viewing page: 1

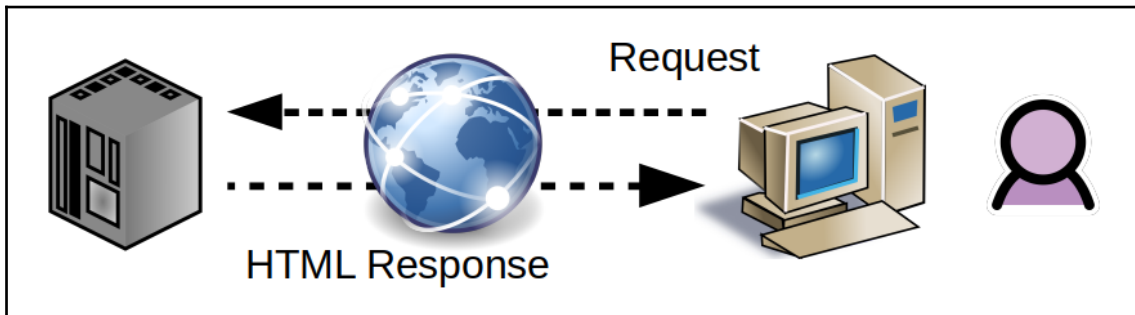

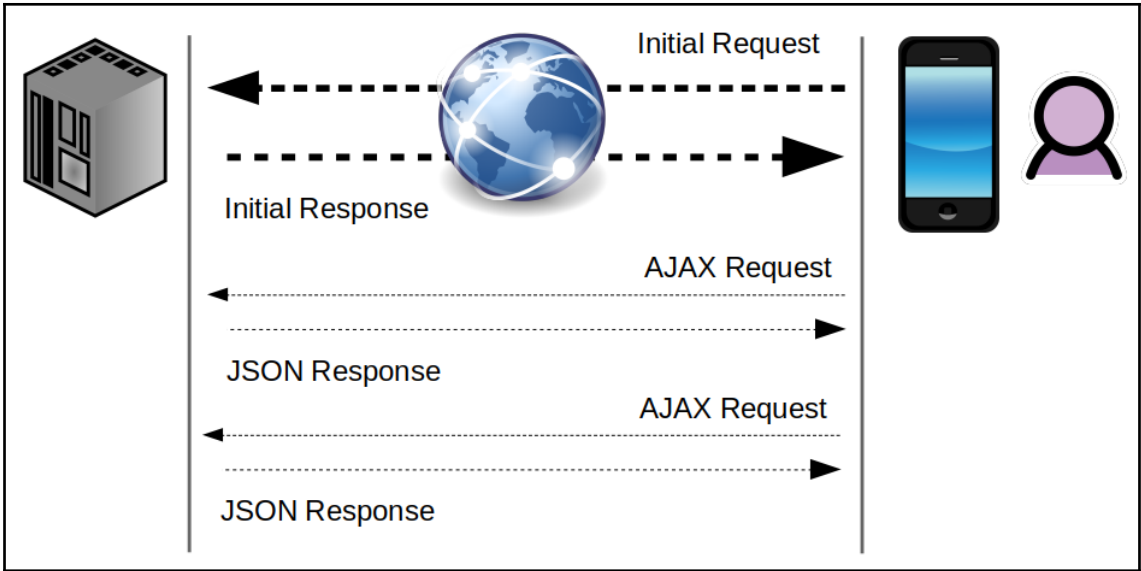

```

learning.mongodb.local/chapter_06/ajax.py
learning.mongodb.local/chapter_06/ajax.py 150%
JSON Raw Data Headers
Save Copy Collapse All Expand All Filter JSON
data:
  0:
    0: "<a href=\"/chapter_06/details.py?product=apple_pie\">Apple Pie</a>"
    1: 4.99
    2: "<input class=\"qty\" name=\"qty_apple_pie\" value=\"0\" type=\"number\" />"
  1:
    0: "<a href=\"/chapter_06/details.py?product=birthday_cake\">Birthday Cake</a>"
    1: 9.99
    2: "<input class=\"qty\" name=\"qty_birthday_cake\" value=\"0\" type=\"number\" />"
  2:
    0: "<a href=\"/chapter_06/details.py?product=black_and_tan_truffel\">Black And Tan Truffel</a>"
    1: 3.49
    2: "<input class=\"qty\" name=\"qty_black_and_tan_truffel\" value=\"0\" type=\"number\" />"
  3:
    0: "<a href=\"/chapter_06/details.py?product=cake_with_chocolate_frosting\">Cake With Chocolate Frosting</a>"
    1: 8.99
    2: "<input class=\"qty\" name=\"qty_cake_with_chocolate_frosting\" value=\"0\" type=\"number\" />"

```

Chap 6: Select

learning.mongodb.local/chapter_06/select.py

Welcome to Sweets Complete

You are logged in as: Yadira Conway

[LOGIN](#) | [RECENT](#) | [HISTORY](#)

Choose Product(s) to Purchase:

Show entries

Search:

Title	Price	Qty
Apple Pie	4.99	<input type="text" value="0"/>
Birthday Cake	9.99	<input type="text" value="0"/>
Black And Tan Truffel	3.49	<input type="text" value="0"/>
Cake With Chocolate Frosting	8.99	<input type="text" value="0"/>
Carrot Cake	7.99	<input type="text" value="0"/>
Cherry Pie	4.99	<input type="text" value="0"/>

Showing 1 to 6 of 26 entries

Previous 2 3 4 5 Next

```
File Edit View Search Terminal Help
> db.products.findOne({}, {"productPhoto":1,"_id":0});
{
  "productPhoto" : "iVBORw0KGgoAAAANSUHEUgAAASwAAADCCAYAAADzRP8zAAAACXBIWXMAAAsTAAALEwEampwYAAAABmJ
LR0QA/wD/AP+gvaeTAABn5E1EQVR42u1dB1gUV9feJGrsil1RsIKCggqCoIJYwIIdQbBhAUHsYkcUFLH3XhNj77Ek9t6NURNjYkxPvvTe
83/l/Pe970DsMjM7W1lk7v0cJxGw3dmZue+c8p736HTacsblArMyzGoyq8usGrMi2mnRlra05UwLwDSZ2WlmfzIjvf2P2QNmGczKa6dJW
9rSVn4uF2YLmP0iAik5+xezAcye006btrSLLUcvT2aPjIGpZiLiFNisLkV3a0HRkf7k5+N0xV8sKn7NZmaltN0nLW1py1GrMrMvxUDVNS
iTdm4cST8/WkL/PVlhf3+wjv7vo/X0550190XdxBR4RHtVrLVJep19Zl7aadSWtrTliLVGDFYzxnRlILWw/v3xBm4/vr2C7r0+k40V8DP
YD+znw2Lb0PPPP0f6MLK/diq1pS1t2X0h6ve+AFadwxpzb0oApX8+XE/tw3nx39Vxq0QTR0TB1fmcW8Lv8d/j24dTbWqVxAAD+BXTDut
2tKwtuyxAC7/FgDr2LbRBL4UwKt5Y3eDvFbRI9QbPcW9CbzuoTXfXN/KUV28BVec04fZmpLW9rSlk1XUWbfCmD0zb1lBoAF27duBD333
HN5KovFXniekgeF0b/eWJwLbgP6tBR+/5iZt3Z6taUtbdlygRx6VQChz24vzANYsL07J5KvVy1JiKNF19K0ND2G/nx/LQ8RRw9pJ/zur2
ZdtF0sLW1py5ZrkgA+u1YnSAKW4EEhXUe4kUvM0/KGLj8fdxz81+zJ3QXvDKEm+N1G19LW9rSlpXreWblmCUKoJMYFyILWE8T8evokxv
zuVfVukWD3HCxV0Rz/jvhdasy43jYqH/vjcx1E65trSLLXMMWQKMNS9nMLjH7W+wledStxnLXpkBL7HV9dD2bh5JC5VBse9eNoFILXxTe
/zyzKto10Ja2tKXkRVXxe1FHmf2sk8hD1aruwnNPVw9NVQ1Wau3i/kLUuWIZ4b0eMPPRLou2tKUtYSGRxo9Zqt6L+o8USFWpWJaGx7Whu
zvG5yGF2trePj0b6rpVFj77J2aR2mXSlrYK70JSG/moEcyu62SaLsuXUn9ewXSkS2j6PfHayTD0HvZZ7cWkr9PbeFY/qMHVC0Zry1tFb
KQrxmztbocGkEekEIDc+/OzWnXqgT66Z0VDgUpY/vx4Urq3Lax+Pi26LRkVLa0VSiWB7N9uhydKg00K13yReravgltXhrP39xbyltsx00
2aK85s2sCndsZkR6ey6A/3nect4Wkfnx0K/HxImytpl10bWnr2VwQz1umE1X4QC1o3NCVxgxtT8e3jeEqC2KKAEzBB8soY0J3cn0tkMcL
q1ShDPXu1JwObRxJf7BQ0d6gBXCcMbqrmEH/ATnf7dJqS1vP1sKmfk+nb40JJC/ak1ZLx9IR5TEp0BDDVa9eqaEqUj1vNauVpTmPrsZgb
```

Welcome to Sweets Complete

Details on Apple Pie

[LOGIN](#) | [SELECT](#) | [RECENT](#)

Apple Pie



Product Key apple_pie
SKU Number APPL501
Category pie
Price 4.99
Unit tin
On Hand 421.0

Morbi consetetur urna sit amet facilisis gravida. Nam gravida libero ac malesuada cursus. Praesent pretium justo at neque egestas mattis. Phasellus vel velit eget nibh porttitor feugiat id ac massa. Pellentesque vel risus placerat, consequat leo suscipit, dapibus nulla.

```
<h2>Birthday Cake</h2>
<table width="80%">
<tr>
  <td align="top">
    <table>
      <tr><th>Product Key</th><td>&nbsp;</td><td>birthday_cake</td></tr>
      <tr><th>SKU Number</th><td>&nbsp;</td><td>BIRT104</td></tr>
      <tr><th>Category</th><td>&nbsp;</td><td>cake</td></tr>
      <tr><th>Price</th><td>&nbsp;</td><td>9.99</td></tr>
      <tr><th>Unit</th><td>&nbsp;</td><td>box</td></tr>
      <tr><th>On Hand</th><td>&nbsp;</td><td>144.0</td></tr>
    </table>
  </td>
</tr>
</table>
<p>In a magna pretium, laoreet neque eget, consetetur justo. Vivamus pharetra sapien at sem ultrices semper. Ut
```

The screenshot shows the RESTClient browser extension interface. At the top, there are navigation icons and a search bar. Below that, there are tabs for 'Authentication', 'Headers', and 'View'. The main area is titled '[-] Request' and contains a 'Method' dropdown set to 'GET', a 'URL' input field with the value 'http://learning.mongodb.local/chapter_06/rest.py?key=cherry_pie', and a red 'SEND' button. Below the request section, there is a 'Headers' section with a 'Remove all' button and a single header 'Accept: application/vnd.api+json'. The 'Body' section is empty. Below the request section, there is a '[-] Response' section with two tabs: 'Headers' and 'Response'. The 'Response' tab is selected, showing a JSON response with a status bar at the top indicating '1' and '2'.

```
1 {"links": {"self": "/chapter_06/rest.py?key=cherry_pie"}, "data": {"1": {"type": "pie", "id": "cherry_pie", "attributes": {"productKey": "cherry_pie", "category": "pie", "title": "Cherry Pie", "price": 4.99}}}}
2
```

The screenshot shows the RESTClient browser extension interface. At the top, there are navigation buttons (back, forward, refresh, home) and a search bar. The main interface is divided into sections for request and response.

Request Section:

- Method: DELETE
- URL: `http://learning.mongodb.local/chapter_06/rest.py?key=cherry_pie`
- Body: (Empty text area)

Response Section:

The response is displayed in a table format with the following headers: Headers, Response, and Preview. The 'Headers' tab is selected.

Header	Value
1. Status Code	: 501 NOT IMPLEMENTED
2. connection	: close
3. content-type	: application/json
4. date	: Sat, 13 Apr 2019 07:42:43 GMT
5. server	: Apache/2.4.29 (Ubuntu)
6. transfer-encoding	: chunked

Chapter 7: Advanced MongoDB Database Design

```
File Edit View Search Terminal Help
.....
-----
Ran 4 tests in 0.000s

OK
-----
(program exited with code: 0)
Press return to continue
█
```

```
chapter_07
├── db.sqlite3
├── booksomeplace_dj
│   ├── __init__.py
│   ├── settings.py
│   ├── urls.py
│   └── wsgi.py
├── manage.py
├── templates
│   ├── booking.html
│   ├── home.html
│   └── layout.html
└──

chapter_07
├── home
│   ├── admin.py
│   ├── apps.py
│   ├── __init__.py
│   ├── migrations
│   │   └── __init__.py
│   ├── models.py
│   ├── tests.py
│   ├── urls.py
│   └── views.py
└──

chapter_07
├── booking
│   ├── admin.py
│   ├── apps.py
│   ├── __init__.py
│   ├── migrations
│   │   └── __init__.py
│   ├── models.py
│   ├── tests.py
│   ├── urls.py
│   └── views.py
└──
```

Book Someplace, Inc. x TYPE CLOUD: Edit Post <Le> x +

booksomeplace.local/booking/

Follow Us: [f](#) [t](#) [in](#) [G+](#) English 08:00 - 17:00 +66 111 222 33 44

 **booksomeplace**

[Home](#) [Your Account](#) [Bookings](#) [Contact Us](#) [Join Us](#)

Book Someplace!

Choose from over 1,000,000 listings worldwide!

- **Parkroyal**
Sed laoreet nulla quis lectus sagittis, sed dictum elit hendrerit.
- **Hyatt**
Cras elit lacus class nascetur sociis lobortis dictum praesent rhoncus, ...
- **Canopy by Hilton**
Quisque quis ipsum commodo, semper ipsum nec, rutrum lacus.
- **7 Days Inn**
Ut viverra neque non auctor cursus.
- **7 Days Inn**
In sodales nisi et elit bibendum, ac vestibulum massa posuere.
- **Country Hearth Inns & Suites**
Ut quis massa sit amet enim faucibus suscipit ac viverra ...
- **SureStay**
Curabitur lobortis ligula id nisi varius, a efficitur ante vestibulum.
- **Novotel**
In a urna a velit condimentum convallis eu gravida urna.
- **Renaissance**
Aenean non ipsum ac enim ultricies vulputate eu non neque.
- **Traders Hotels**
Sociis velit dui commodo consequat cursus primis eu orci quis ...

Chapter 8: Using Documents with Embedded Lists and Objects

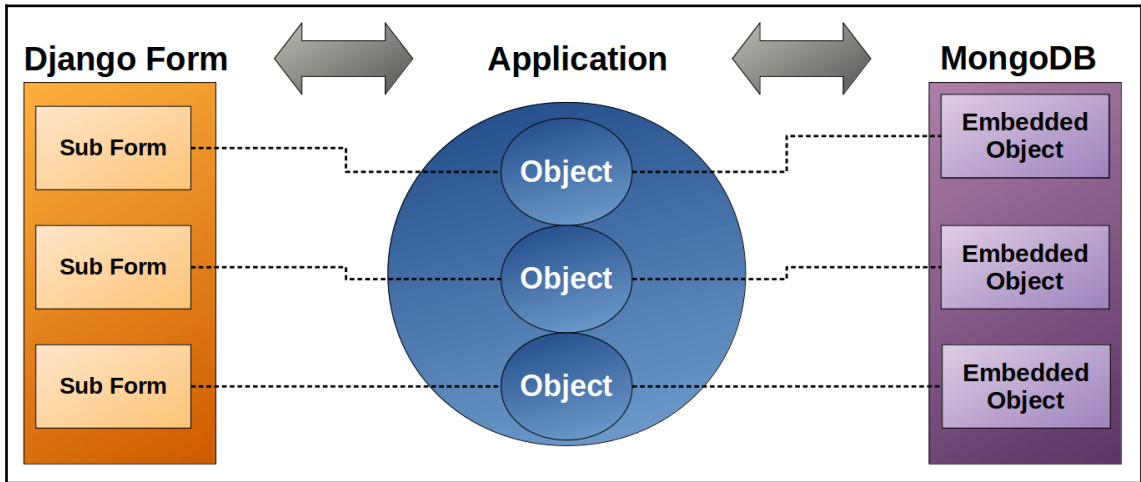

Add/Edit Property

Name of Property: The Grotto

Property Name

Partner: Accomodation Accomdations

Property Name: The Grotto

There are a number of things which we've left out of this implementation:

- Partner login
- Only allowing edits for properties belonging this partner to be edited

Property Location

Street Address: 240 Gravel Road

Building Name:

Floor:

Room/Condo:

City: Bedrock

State/Province: MI

Locality:

Country: US

Postal Code: 00000

Latitude: 111.111

Longitude: -111.111

Contact Name

Title: Mr

First Name: Fred

M.I.: F

Last Name: Flintstone

Suffix:

Contact Info

Email: fred@flintstone.com

Phone: 111-222-3333

Social Media: google

Social Media Identity:

Property Info

Property Type: hotel

Book Someplace, Inc. x +

chap08.booksomplace.local/property/room/add/MAJE2976/ 120% Search

 **booksomplace** [Home](#) [Your Account](#) [Bookings](#) [Partners](#) [Contact Us](#) [Join Us](#)

Room Type

Add rooms to the property Romantic Lodge

Room Type:

View:

Description:

This one-of-a-kind room offers a splendid view of a vast primeval forest. One can just imagine Tarzan swinging through the vines, beating his chest, offering up a savage challenge to the denizens of the jungle.

How Many?

Price (USD):

Bed Types: **single** **single** **double** **double** **queen** **king**

Please enter room information

```
File Edit View Search Terminal Help
{
  "roomTypeKey" : "STAN9675",
  "type" : "standard",
  "view" : "forest",
  "description" : "This one-of-a-kind room offers a
splendid view of a vast primeval forest. One can just imagine Tarzan sw
inging through the vines, beating his chest, offering up a savage challen
ge to the denizens of the jungle.",
  "beds" : [
    "single",
    "single"
  ],
  "numAvailable" : 5,
  "numBooked" : 0,
  "price" : 88
}
]
}
}
> db.properties.findOne({"propertyKey":"MAJE2976"},{"_id":0,"rooms":1});
```

Update Property Contact

Partner: **Property:**

Contact Name	Contact Info
Title: <input type="text" value="Mr"/>	Email: <input type="text"/>
First Name: <input type="text"/>	Phone: <input type="text"/>
M.I.: <input type="text"/>	Social Media: <input type="text" value="google"/>
Last Name: <input type="text"/>	Social Media Identity: <input type="text"/>
Suffix: <input type="text"/>	

Update Property Contact

Partner: Boutique Agency Inc

Property: Destination Inn

Contact Name

Title:

First Name:

Contact Info

Email:

Phone:

- Destination Inn
- Majestic Hotel
- Quiet Hall
- Sterling Hotel
- Graystoke Hotel

Update Property Contact

Partner: Boutique Agency Inc

Property: Quiet Hall

Contact Name

Title:

First Name:

M.I.:

Last Name:

Suffix:

Contact Info

Email:

Phone:

Social Media:

Social Media Identity:

TYPE CLOUD: Edit Post < Le... x Book Someplace, Inc. x +

chap08.booksomeplace.local/property/list/MAJ Search

Follow Us: f t in G+ English 08:00 - 17:00 +66 111 222 33 44

booksomeplace Home Your Account Bookings Partners Contact Us Join Us

Property Listing

Name Romantic Lodge

Type hotel

Description Donec sed dui hendrerit nulla iaculis vestibulum.



Room Types

Type	View	Beds	Available	Info
suite	city	king, queen	54	Details
family	mountain	king, king	94	Details
double	pleasant	double, queen, king	47	Details
premium	Lakeside	single, king	10	Details
poolside	pool	single, single	20	Details
standard	forest	single, single	18	Details

Choose Partner and Property to Delete

Partner: Success Business Inc

Property: Destination Destination

Confirm Deletion

Name Destination Destination

Type b & b

Description Nulla placerat massa
eget libero ornare
lacinia.

DELETE?

Yes

No

Chapter 9: Handling Complex Queries in MongoDB

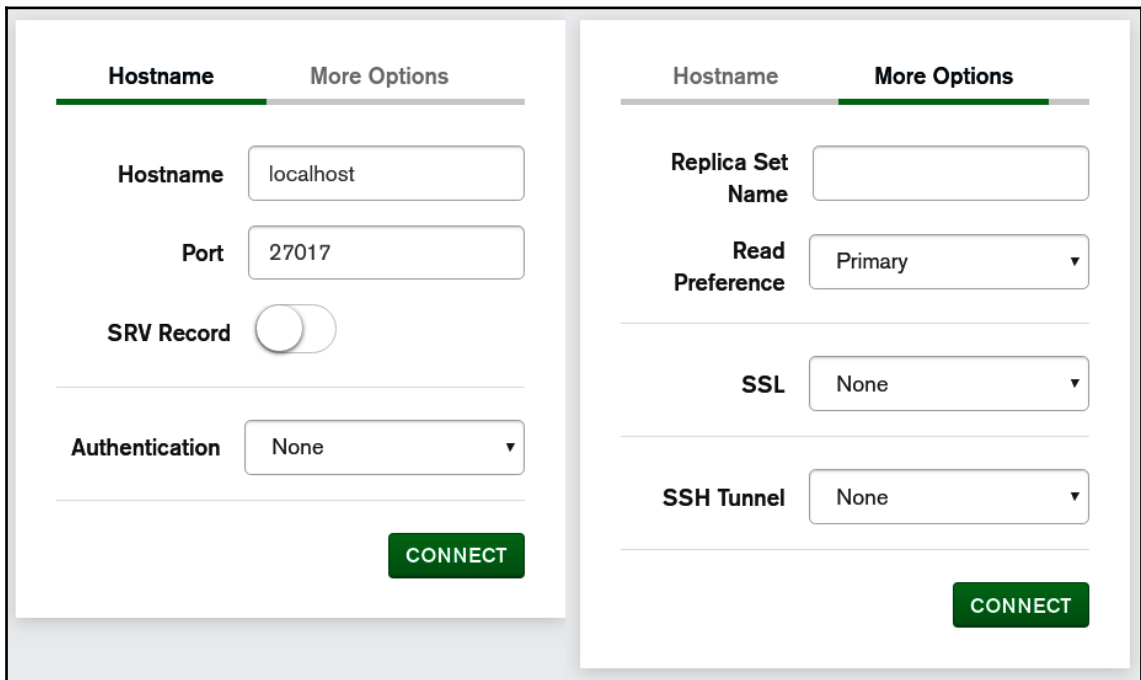
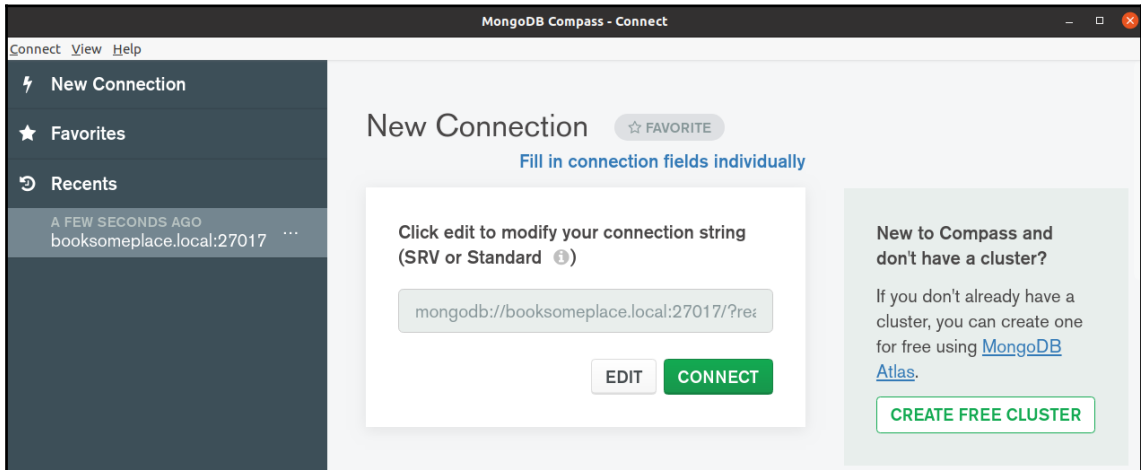

SSL	Server and Client Validation ▼
Certificate Authority ⓘ	⬆ SELECT FILES...
Client Certificate ⓘ	⬆ SELECT A FILE...
Client Private Key ⓘ	⬆ SELECT A FILE...
Client Key Password ⓘ

SSH Tunnel	Use Password ▼
SSH Hostname ⓘ	ssh.unlikelysource.com
SSH Tunnel Port	9999
SSH Username	doug
SSH Password

SSH Tunnel Use Identity File ▼

SSH Hostname ⓘ ssh.unlikelysource.com

SSH Tunnel Port 22

SSH Username doug

SSH Identity File  SELECT A FILE...

SSH Passphrase

Connect View Help

Local

5 DBS 10 COLLECTIONS C

☆ FAVORITE

HOST localhost:27017

CLUSTER Standalone





EDITION MongoDB 4.4.0-rc5 Community

Q Filter your data

- > admin
- > booksomeplace
- > config
- > local
- > sweetscomplete

Databases

CREATE DATABASE

Database Name ^	Storage Size	Collections	Indexes	
admin	20.0KB	0	1	
booksomeplace	3.6MB	5	5	
config	20.0KB	0	2	
local	20.0KB	1	1	
sweetscomplete	1.5MB	4	4	

Connect View Collection Help

Local

5 DBS 10 COLLECTIONS

☆ FAVORITE

HOST
localhost:27017

CLUSTER
Standalone

EDITION
MongoDB 4.4.0-rc5
Community

Filter your data

- admin
- booksomeplace
 - bookings
 - common
 - customers
 - partners
 - properties
 - world_cities
- config
- local
- sweetscomplete

booksomeplace.bookings Documents

DOCUMENTS 2.0k TOTAL SIZE 3.3MB AVG. SIZE 1.7KB INDEXES 1 TOTAL SIZE 4.0KB AVG. SIZE 4.0KB

Documents Aggregations Explain Plan Indexes

FILTER OPTIONS FIND RESET

ADD DATA VIEW

Displaying documents 1 - 20 of 1978 REFRESH

```
> _id: ObjectId("5ebf7e06cc5646a656872af0")
  bookingKey: "20190710SCOT"
  customer: Object
  property: Object
  bookingInfo: Object
  rooms: Array
  totalPrice: 1305

_id: ObjectId("5ebf7e06cc5646a656872af1")
  bookingKey: "20100416MALO"
  customer: Object
  property: Object
  bookingInfo: Object
  rooms: Array
  totalPrice: 156

_id: ObjectId("5ebf7e06cc5646a656872af2")
  bookingKey: "20190801PRUI"
  customer: Object
  property: Object
  bookingInfo: Object
  rooms: Array
  totalPrice: 557
```

Import To Collection booksomeplace.partners ✕

Select File

📁 BROWSE

Select Input File Type

JSON CSV

Options

Ignore empty strings

Stop on errors

Specify Fields and Types

	<input checked="" type="checkbox"/> title String	<input checked="" type="checkbox"/> first String	<input checked="" type="checkbox"/> middle String
1	Mr	Frederick	F
2	345 Cave Stone Road	null	null
3	fred@flintstones.com	+1-222-333-4444	fred@gmail.com
4	f Flintstone	<i>empty string</i>	\$2y\$10\$efV/b5Bj4UHjclYhJ4hREe3MeGMm/l.8/o0
5	[]	[]	[]
6	M	-1000000	

CANCEL
IMPORT

DOCUMENTS **2.0k** TOTAL SIZE 3.3MB AVG. SIZE 1.7KB INDEXES **1** TOTAL SIZE 4.0KB AVG. SIZE 4.0KB

booksomeplace.bookings

Documents Aggregations Explain Plan Indexes

FILTER customer.| **OPTIONS** **FIND** **RESET** ...

ADD documents 1 - 20 of 1978 **REFRESH**

- "customer.customerAddr" field
- "customer.customerAddr.buildingName" field
- "customer.customerAddr.city" field
- "customer.customerAddr.country" field
- "customer.customerAddr.floor" field
- "customer.customerAddr.latitude" field
- "customer.customerAddr.locality" field
- "customer.customerAddr.longitude" field
- > bookingInfo: Object
- > rooms: Array
- totalPrice: 1305

DOCUMENTS **2.0k** TOTAL SIZE 3.3MB AVG. SIZE 1.7KB INDEXES **1** TOTAL SIZE 4.0KB AVG. SIZE 4.0KB

booksomeplace.bookings

Documents Aggregations Explain Plan Indexes

FILTER "customer.customerContact.socMedia.facebook":\$ **OPTIONS** **FIND** **RESET** ...

ADD DATA **VIEW** **REFRESH**

- \$all query
- \$and query
- \$bitsAllClear query
- \$bitsAllSet query
- \$bitsAnyClear query
- \$bitsAnySet query
- \$comment query
- \$elemMatch query

```

_id: ObjectId("5ebf7e06cc5646a656872a")
bookingKey: "20190710SCOT"
customer: Object
property: Object
bookingInfo: Object
rooms: Array
totalPrice: 1305

```

booksomeplace.bookings DOCUMENTS 2.0k TOTAL SIZE 3.3MB AVG. SIZE 1.7KB INDEXES 1 TOTAL SIZE 4.0KB AVG. SIZE 4.0KB

Documents Aggregations Explain Plan Indexes

FILTER {"customer.customerContact.socMedia.facebook":{"exists:true}} OPTIONS FIND RESET ...

PROJECT {"customer.customerContact":1,"customer.customerName":1,"totalPrice":1}

SORT [{"customer.customerName.last":1,"customer.customerName.first":1} MAXTIMEMS 5000

COLLATION SKIP 0 LIMIT 6

VIEW [List Icon] [JSON Icon] [Table Icon] Displaying documents 1 - 6 of 6 < > REFRESH

bookings

	_id ObjectId	customer Object	totalPrice Double
1	5ebf7e07cc5646a656872b02	{ } 2 fields	468
2	5ebf7e07cc5646a656872b05	{ } 2 fields	175
3	5ebf7e07cc5646a656872aff	{ } 2 fields	79
4	5ebf7e07cc5646a656872afd	{ } 2 fields	2660
5	5ebf7e07cc5646a656872b00	{ } 2 fields	1435
6	5ebf7e07cc5646a656872b1a	{ } 2 fields	480

DOCUMENTS **2.0k** TOTAL SIZE 3.3MB AVG. SIZE 1.7KB

INDEXES **1** TOTAL SIZE 4.0KB AVG. SIZE 4.0KB

booksomeplace.bookings

Documents Aggregations Explain Plan Indexes

FILTER {"customer.customerContact.socMed":1} **OPTIONS** **FIND** **RESET** ...

PROJECT [{"customer.customerContact":1,"customer.custor

SORT {"customer.customerName.last":1} **MAXTIMEMS** 50

COLLATION **SKIP** 0 **LIMIT** 6

VIEW Displaying documents 1 - 6 of 6 **REFRESH**

bookings

_id	ObjectId	customer	Object
1	5ebf7e07cc5646a656872b02	{}	2 fields
2	5ebf7e07cc5646a656872b05	{}	2 fields
3	5ebf7e07cc5646a656872aff	{}	2 fields
4	5ebf7e07cc5646a656872afd	{}	2 fields
5	5ebf7e07cc5646a656872b00	{}	2 fields
6	5ebf7e07cc5646a656872b1a	{}	2 fields

Past Queries **RECENT** FAVORITES

Sat May 16 2020 13:01:05 GMT+0700 (In...

FILTER

```
{
  'customer.customerContact.socMedia.face$exists': true
}
```

PROJECT

```
{
  'customer.customerContact': 1,
  'customer.customerName': 1,
  totalPrice: 1
}
```

SORT

```
{
  'customer.customerName.last': 1,
  'customer.customerName.first': 1
}
```

LIMIT

6

```
File Edit View Search Terminal Help
L Tang          ltang110@telecom.com@facebook.com    1110.00
L Tang          ltang110@telecom.com@facebook.com     57.00
L Tang          ltang110@telecom.com@facebook.com    374.00
L Tang          ltang110@telecom.com@facebook.com    480.00
L Tang          ltang110@telecom.com@facebook.com    300.00
L Tang          ltang110@telecom.com@facebook.com    930.00
A Turner        aturner136@singtel.com@facebook.com   54.00
A Turner        aturner136@singtel.com@facebook.com  278.00
A Turner        aturner136@singtel.com@facebook.com  159.00
A Turner        aturner136@singtel.com@facebook.com 1557.00
A Turner        aturner136@singtel.com@facebook.com  111.00
A Turner        aturner136@singtel.com@facebook.com 2260.00
A Turner        aturner136@singtel.com@facebook.com  201.00
A Turner        aturner136@singtel.com@facebook.com 2000.00
W Yang         wyang329@vodafone.com@facebook.com   2660.00
W Yang         wyang329@vodafone.com@facebook.com   279.00
W Yang         wyang329@vodafone.com@facebook.com   272.00
W Yang         wyang329@vodafone.com@facebook.com   712.00
W Yang         wyang329@vodafone.com@facebook.com  2672.00
W Yang         wyang329@vodafone.com@facebook.com  2673.00
W Yang         wyang329@vodafone.com@facebook.com   795.00
W Yang         wyang329@vodafone.com@facebook.com  1755.00
-----
TOTAL                                     219742.00
root@server1:/repo/chapters/09# python compass_query_involving_embedded_objects.py
```

Connect View Collection Help

booksomeplace.properties Documents

booksomeplace.properties DOCUMENTS 481 TOTAL SIZE 2.3MB AVG. SIZE 4.9KB INDEXES 1 TOTAL SIZE 24.0KB AVG. SIZE 24.0KB

Documents Aggregations Explain Plan Indexes

FILTER OPTIONS FIND RESET ...

ADD DATA VIEW {}

Displaying documents 1 - 20 of 481 REFRESH

```
_id: ObjectId("5ebf75343f99ef192aace4a5")
propertyKey: "PASS6323"
partnerKey: "LAZYJCCUM9702"
propName: "Lakeside Stay"
propInfo: Object
address: Object
contactName: Object
contactInfo: Object
rooms: Array
reviews: Array
  0: Object
    customerKey: "LISBCHUR2678"
    staff: 1
    cleanliness: 5
    facilities: 5
    comfort: 2
    goodStuff: ""
    badStuff: ""
  1: Object
  2: Object
  3: Object
  4: Object
```

FILTER {"reviews.cleanliness":{\$lt:3}} OPTIONS FIND RESET ...

ADD DATA VIEW {}

Displaying documents 1 - 20 of 367 REFRESH

```

File Edit View Search Terminal Help
Valley Hall          Cutella AU          1.33
Valley Hall          Gadra Road IN       1.67
Valley Hall          Munroe Falls US     1.56
Valley Hotel         Hyde Park AU        1.82
Valley Hotel         Mekinock US         1.79
Valley Inn           Столът / Stolut BG  1.67
Valley Inn           St. George's BM     1.52
Valley Keep          West Kootenays (Rossland) CA 1.85
Valley Keep          Kings County (Kingston) CA 1.43
Valley Lodge         Port Macdonnell AU  1.79
Valley Stay          Saint-Pierre PM     1.67
Valley Stay          Broadwood NZ        1.70
Valley Stay          Соколове UA        2.14
Voyage Destination  Hampstead CA        1.25
Voyage Destination  Edenhope AU         1.72
Voyage Hotel         Peterd HU           1.59
Voyage Inn           Parrott US          1.86
Voyage Inn           Ammandivilai IN     1.54
Voyage Inn           East York (Leaside) CA 1.84
Voyage Keep          Mitana IN           1.67
Voyage Lodge         Downsview East (CFB Toronto) CA 2.35
Voyage Lodge         Wallace US           1.67
Voyage Lodge         Gloucester (Blackburn Hamlet / Pine View) 1.44
Voyage Resort        Manchester GB        1.74
root@server1:/repo/chapters/09# python compass_query_involving_arrays.py

```

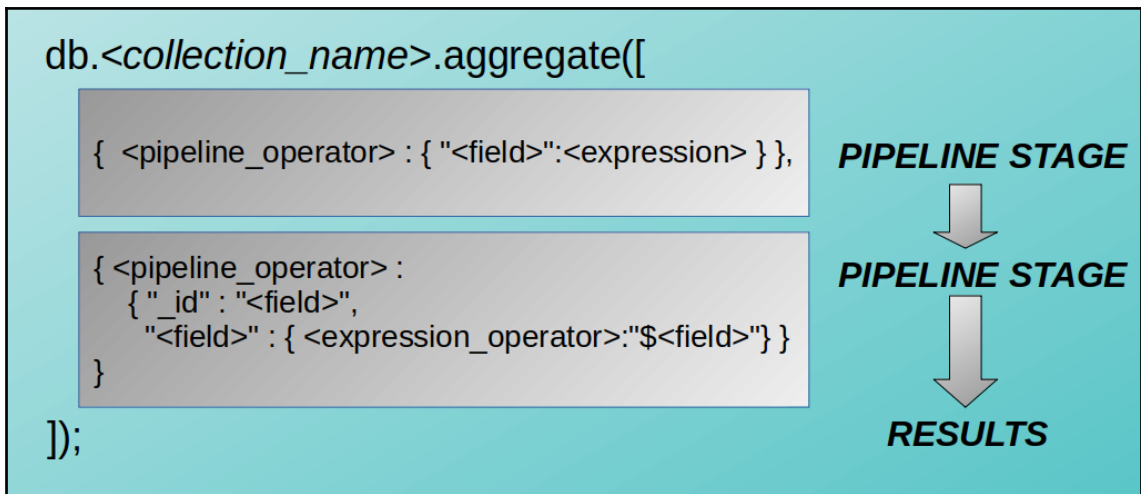

```
File Edit View Search Terminal Help
MongoDB jed@test[up:72566 secs]
2>use booksomeplace;
switched to db booksomeplace

MongoDB jed@booksomeplace[up:72578 secs]
3>db.bookings.aggregate([
...     { $match : { "bookingInfo.paymentStatus" : "confirmed" } },
...     { $group: { "_id"      : "$customer.customerAddr.country",
...                   "total" : { $sum : "$totalPrice" } } },
...     { $sort : { "_id" : 1 } }
...  ]);
{ "_id" : "AD", "total" : 4770 }
{ "_id" : "AR", "total" : 4500 }
{ "_id" : "AT", "total" : 12329 }
{ "_id" : "AU", "total" : 122733 }
{ "_id" : "AX", "total" : 3351 }
{ "_id" : "BD", "total" : 12319 }
{ "_id" : "BM", "total" : 6687 }
{ "_id" : "BR", "total" : 7679 }
{ "_id" : "BY", "total" : 7870 }
{ "_id" : "CA", "total" : 87550 }
{ "_id" : "CH", "total" : 10729 }
{ "_id" : "CL", "total" : 2804 }
{ "_id" : "CR", "total" : 3474 }
{ "_id" : "CZ", "total" : 19195 }
{ "_id" : "DE", "total" : 3984 }
{ "_id" : "DK", "total" : 9554 }
{ "_id" : "DO", "total" : 14265 }
{ "_id" : "ES", "total" : 3190 }
{ "_id" : "FI", "total" : 14006 }
{ "_id" : "FM", "total" : 4570 }
Type "it" for more

MongoDB jed@booksomeplace[up:72581 secs]
4>
```

```
File Edit View Search Terminal Help
{ "full_name" : "Ms Leann M. Aguilar" }
{ "full_name" : "Ms Renato H. Allen" }
{ "full_name" : "Latarsha Alvarez" }
{ "full_name" : "Ms Jolyn G. Anderson" }
{ "full_name" : "Mr Junior G. Archer" }
{ "full_name" : "Ms Margret Z. Arroyo" }
{ "full_name" : "Mr Darrel X. Atkinson" }
{ "full_name" : "Tiffani Austin" }
{ "full_name" : "Ms Lan W. Avila" }
{ "full_name" : "Mr Scotty Z. Ayala" }
{ "full_name" : "Mr Shannon C. Ballard" }
{ "full_name" : "Mr Boyd J. Ballard" }
{ "full_name" : "Mr Gilbert G. Barber" }
{ "full_name" : "Ms Danyelle M. Barber" }
{ "full_name" : "Ms Jerica G. Barber" }
{ "full_name" : "Ms Belen S. Barker" }
{ "full_name" : "Rudolph Barnes" }
{ "full_name" : "Ms Jessica D. Barrera" }
{ "full_name" : "Mr Xavier D. Beasley" }
{ "full_name" : "Mr Allen Z. Beasley" }
Type "it" for more

MongoDB jed@booksomeplace[up:72912 secs]
5>
```

```
File Edit View Search Terminal Help
MongoDB jed@booksomeplace[up:73383 secs]
9>db.bookings.mapReduce(map_func, reduce_func, { query: query_doc, out: output_to });
{ "result" : "country_totals", "ok" : 1 }

MongoDB jed@booksomeplace[up:73396 secs]
10>db.country_totals.find();
{ "_id" : "FR", "value" : 158 }
{ "_id" : "DE", "value" : 2486 }
{ "_id" : "PK", "value" : 1033 }
{ "_id" : "FM", "value" : 362 }
{ "_id" : "BR", "value" : 3125 }
{ "_id" : "DK", "value" : 3650 }
{ "_id" : "NL", "value" : 5808 }
{ "_id" : "CO", "value" : 1230 }
{ "_id" : "LI", "value" : 3523 }
{ "_id" : "TH", "value" : 355 }
{ "_id" : "SI", "value" : 2468 }
{ "_id" : "UA", "value" : 1078 }
{ "_id" : "SJ", "value" : 2332 }
{ "_id" : "YT", "value" : 2457 }
{ "_id" : "LK", "value" : 3499 }
{ "_id" : "LV", "value" : 197 }
{ "_id" : "FI", "value" : 6354 }
{ "_id" : "AT", "value" : 5580 }
{ "_id" : "MT", "value" : 2768 }
{ "_id" : "JP", "value" : 2203 }
Type "it" for more

MongoDB jed@booksomeplace[up:73442 secs]
11>
```

```
File Edit View Search Terminal Help
MongoDB jed@booksomeplace[up:74110 secs]
37>db.world_cities.findOne({},{"geo_spatial_flat":1});
{
  "_id" : ObjectId("5ebf753a0db42badd870ebfe"),
  "geo_spatial_flat" : [
    1.53414,
    42.50729
  ]
}
MongoDB jed@booksomeplace[up:74215 secs]
38>
```



```
File Edit View Search Terminal Help
MongoDB jed@booksomeplace[up:74082 secs]
35>db.world_cities.createIndex( { "geo_spatial_flat" : "2d" } );
{
  "createdCollectionAutomatically" : false,
  "numIndexesBefore" : 1,
  "numIndexesAfter" : 2,
  "ok" : 1
}
MongoDB jed@booksomeplace[up:74097 secs]
36>db.world_cities.getIndexes();
[
  {
    "v" : 2,
    "key" : {
      "_id" : 1
    },
    "name" : "_id_"
  },
  {
    "v" : 2,
    "key" : {
      "geo_spatial_flat" : "2d"
    },
    "name" : "geo_spatial_flat_2d"
  }
]
```

```

File Edit View Search Terminal Help
> db.world_cities.find(
...   { "geo_spatial_sphere" :
...     { "$near" : {
...       "$geometry" : {
...         "type" : "Point",
...         "coordinates" : [77.8956, 18.0806]
...       },
...       "$maxDistance" : 100000
...     }
...   }
... }, { "name" : 1, "geo_spatial_sphere" : 1, "_id" : 0 });
{ "name" : "Bānswāda", "geo_spatial_sphere" : [ 77.88007, 18.37725 ] }
{ "name" : "Andol", "geo_spatial_sphere" : [ 78.07713, 17.81458 ] }
{ "name" : "Medak", "geo_spatial_sphere" : [ 78.26078, 18.04531 ] }
{ "name" : "Bīdar", "geo_spatial_sphere" : [ 77.53011, 17.91331 ] }
{ "name" : "Sadāseopet", "geo_spatial_sphere" : [ 77.95263, 17.61925 ] }
{ "name" : "Zahirābād", "geo_spatial_sphere" : [ 77.60743, 17.68138 ] }
{ "name" : "Aurād", "geo_spatial_sphere" : [ 77.41761, 18.25397 ] }
{ "name" : "Kāmāreddi", "geo_spatial_sphere" : [ 78.34177, 18.32001 ] }
{ "name" : "Sangāreddi", "geo_spatial_sphere" : [ 78.08669, 17.62477 ] }
{ "name" : "Dīglūr", "geo_spatial_sphere" : [ 77.57695, 18.54829 ] }
{ "name" : "Bodhan", "geo_spatial_sphere" : [ 77.88581, 18.66208 ] }
{ "name" : "Nizāmābād", "geo_spatial_sphere" : [ 78.0988, 18.67154 ] }
{ "name" : "Singāpur", "geo_spatial_sphere" : [ 78.12574, 17.46982 ] }
{ "name" : "Patancheru", "geo_spatial_sphere" : [ 78.2645, 17.53334 ] }
{ "name" : "Bhālki", "geo_spatial_sphere" : [ 77.206, 18.04348 ] }
{ "name" : "Serilingampalle", "geo_spatial_sphere" : [ 78.30196, 17.49313 ] }
{ "name" : "Vikārābād", "geo_spatial_sphere" : [ 77.90441, 17.3381 ] }
{ "name" : "Chincholi", "geo_spatial_sphere" : [ 77.41874, 17.46508 ] }
{ "name" : "Kūkatpalli", "geo_spatial_sphere" : [ 78.41376, 17.48486 ] }
{ "name" : "Quthbullapur", "geo_spatial_sphere" : [ 78.45818, 17.50107 ] }
Type "it" for more
>

```

```
root@server1: /repo/chapters/09
{
  "bookingInfo" : {
    "arrivalDate" : "2018-03-21 14:07:00",
    "departureDate" : "2018-03-28 14:00:00",
    "checkoutTime" : "14:00:00",
    "refundableUntil" : "2018-03-20 14:07:00",
    "reservationStatus" : "confirmed",
    "paymentStatus" : "confirmed"
  },
  "rooms" : [
    {
      "roomType" : "VIP",
      "roomTypeKey" : "dd49",
      "price" : 100,
      "qty" : 1
    },
    {
      "roomType" : "family",
      "roomTypeKey" : "bb51",
      "price" : 258,
      "qty" : 2
    }
  ]
}
Type "it" for more
> db.bookings.find({},{"bookingInfo":1,"rooms":1,"_id":0}).pretty();
```

```

root@server1: /repo/chapters/09
> db.bookings.aggregate([{$wind : "$rooms"},{$project: {$"bookingKey":1,"rooms":1,"_id":0}}]);
{ "bookingKey" : "20190710SCOT", "rooms" : { "roomType" : "premium", "roomTypeKey" : "aa44", "price" : 435, "qty" : 3 } }
{ "bookingKey" : "20180416MALO", "rooms" : { "roomType" : "VIP", "roomTypeKey" : "aa75", "price" : 156, "qty" : 1 } }
{ "bookingKey" : "20190801PRUI", "rooms" : { "roomType" : "premium", "roomTypeKey" : "bb72", "price" : 117, "qty" : 1 } }
{ "bookingKey" : "20190801PRUI", "rooms" : { "roomType" : "suite", "roomTypeKey" : "cc45", "price" : 232, "qty" : 1 } }
{ "bookingKey" : "20190801PRUI", "rooms" : { "roomType" : "standard", "roomTypeKey" : "aa66", "price" : 104, "qty" : 2 } }
{ "bookingKey" : "20181210FUEN", "rooms" : { "roomType" : "VIP", "roomTypeKey" : "bb14", "price" : 115, "qty" : 1 } }
{ "bookingKey" : "20181210FUEN", "rooms" : { "roomType" : "standard", "roomTypeKey" : "aa99", "price" : 372, "qty" : 2 } }
{ "bookingKey" : "20201106WHIT", "rooms" : { "roomType" : "family", "roomTypeKey" : "aa24", "price" : 298, "qty" : 2 } }
{ "bookingKey" : "20180907KNOX", "rooms" : { "roomType" : "standard", "roomTypeKey" : "aa53", "price" : 296, "qty" : 2 } }
{ "bookingKey" : "20180907KNOX", "rooms" : { "roomType" : "standard", "roomTypeKey" : "aa53", "price" : 296, "qty" : 2 } }
{ "bookingKey" : "20210220ESTR", "rooms" : { "roomType" : "standard", "roomTypeKey" : "aa58", "price" : 400, "qty" : 4 } }
{ "bookingKey" : "20181105HOWE", "rooms" : { "roomType" : "suite", "roomTypeKey" : "bb85", "price" : 45, "qty" : 1 } }
{ "bookingKey" : "20191005PATT", "rooms" : { "roomType" : "double", "roomTypeKey" : "dd88", "price" : 489, "qty" : 3 } }
{ "bookingKey" : "20171214SWEE", "rooms" : { "roomType" : "double", "roomTypeKey" : "aa66", "price" : 51, "qty" : 1 } }
{ "bookingKey" : "20171214SWEE", "rooms" : { "roomType" : "double", "roomTypeKey" : "aa66", "price" : 51, "qty" : 1 } }
{ "bookingKey" : "20200513NORM", "rooms" : { "roomType" : "premium", "roomTypeKey" : "aa60", "price" : 159, "qty" : 1 } }
{ "bookingKey" : "20200513NORM", "rooms" : { "roomType" : "premium", "roomTypeKey" : "aa60", "price" : 159, "qty" : 1 } }
{ "bookingKey" : "20200513NORM", "rooms" : { "roomType" : "premium", "roomTypeKey" : "cc83", "price" : 504, "qty" : 3 } }
{ "bookingKey" : "20171003NAVA", "rooms" : { "roomType" : "family", "roomTypeKey" : "cc23", "price" : 184, "qty" : 1 } }
{ "bookingKey" : "20171003NAVA", "rooms" : { "roomType" : "premium", "roomTypeKey" : "bb97", "price" : 241, "qty" : 1 } }
Type "it" for more
> █

```

```

root@server1: /repo/chapters/09# python financial_query_sales_by_room_type.py
Sales by Room Type For 2019
Type          Qty          Amount
-----
standard      131.0        54375.00
VIP           144.0        50292.00
suite         102.0        33789.00
double        184.0        63946.00
premium       120.0        40375.00
family        99.0         30834.00
=====
TOTAL         780.0        273611.00
root@server1: /repo/chapters/09# █

```

```

File Edit View Search Terminal Help
root@server1: /repo/chapters/09# python financial_30_60_90_day_aging_report_using_aggregation.py
.....
FROM: 2020-12-01
30: 2020-11-01 | 60: 2020-10-02 | 90: 2020-09-02
.....
Aging in Days      From Aggr      From Amts
-----
90                  24816.00      24816.00
60                  14576.00      14576.00
30                  35384.00      35384.00
=====
TOTAL              74776.00      74776.00
.....
root@server1: /repo/chapters/09#

```

Future Revenue Trends by Property Location

Enter Trend Data

City:

Region:

Locality:

Country:

Factor:

Make changes to the report parameters to update the chart

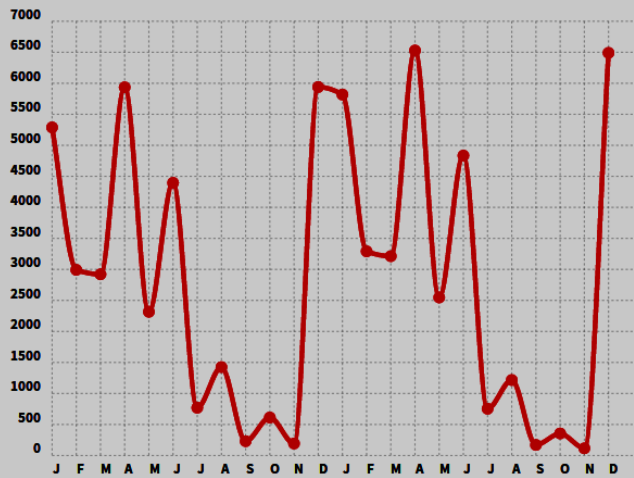

Chapter 10: Working with Complex Documents Across Collections

BigLittle Micro Finance Ltd			View release notes for Django 2.2		
Total Amount Lent By Lender					
Business	Country	Total Lent	Business	Country	Total Lent
Nonstop Trust Inc	AU	18700.000000000000	Illuminati Partners	AU	8100.000000000000
Comfort Partners Company	AU	4500.000000000000	Industrious Holdings Company	BY	7400.000000000000
Leisure Associates LLC	CA	22500.000000000000	Comfort Industries Ltd	CA	19000.000000000000
Bizarro Trust Ltd	CA	18000.000000000000	Powerhouse Associates Ltd	CA	16600.000000000000
Lazy Bird Holdings Inc	CA	14200.000000000000	Lazy Bird Partners Inc	CA	10700.000000000000
Serious Associates	CZ	6600.000000000000			
Industrious Holdings	GB	81200.000000000000	Lazy Bird Partners LLC	GB	10600.000000000000
Lazy Bird Trust Ltd	GB	7700.000000000000	Specialty Associates LLC	GT	7200.000000000000
Comfort Associates Company	IE	19600.000000000000	Lazy Bird Partners Company	IE	13000.000000000000
Accomodation Associates Inc	IN	16000.000000000000	Ninety Nine Percenter Associates	IN	10400.000000000000
Leisure Associates Inc	IN	6400.000000000000	Bizarro Partners Ltd	IN	3900.000000000000
Leisure Associates	IN	1800.000000000000	Friendly Associates LLC	LI	5200.000000000000
Industrious Industries LLC	MK	35800.000000000000			
Powerhouse Business Company	PL	33600.000000000000			
Powerhouse Partners Inc	PR	11100.000000000000	Accomodation Trust Ltd	RE	3600.000000000000
Friendly Trust LLC	SE	13900.000000000000			
Round the Clock Business Ltd	TH	13100.000000000000	Illuminati Trust	TH	12800.000000000000
Nonstop Holdings	UA	22200.000000000000	Serious Industries Inc	US	18200.000000000000
Friendly Associates	US	14700.000000000000	Powerhouse Associates LLC	US	10800.000000000000
Industrious Partners LLC	YT	18800.000000000000	Specialty Holdings Inc	ZA	21000.000000000000

```

File Edit View Search Terminal Help
> db.users.find({},{"userKey":1,"name.first":1,"name.last":1});
{ "_id" : ObjectId("5ec4d4d0ec2b5adab4754de0"), "userKey" : "CHARROSS3456", "name" : { "first" : "Charisse", "last" : "Ross" } }
{ "_id" : ObjectId("5ec4d4d0ec2b5adab4754de1"), "userKey" : "CLYDR0JA7788", "name" : { "first" : "Clyde", "last" : "Rojas" } }
{ "_id" : ObjectId("5ec4d4d0ec2b5adab4754de2"), "userKey" : "ERICPOLL6194", "name" : { "first" : "Ericka", "last" : "Pollard" } }
{ "_id" : ObjectId("5ec4d4d0ec2b5adab4754de3"), "userKey" : "MYRTMCCA8673", "name" : { "first" : "Myrtie", "last" : "Mccall" } }
{ "_id" : ObjectId("5ec4d4d0ec2b5adab4754de4"), "userKey" : "CELIBLAC8153", "name" : { "first" : "Celina", "last" : "Black" } }
{ "_id" : ObjectId("5ec4d4d0ec2b5adab4754de5"), "userKey" : "KEIKSIER2074", "name" : { "first" : "Keiko", "last" : "Sierra" } }
{ "_id" : ObjectId("5ec4d4d0ec2b5adab4754de6"), "userKey" : "KATHHOWE6236", "name" : { "first" : "Kathe", "last" : "Howell" } }
{ "_id" : ObjectId("5ec4d4d0ec2b5adab4754de7"), "userKey" : "CLAUMUN00734", "name" : { "first" : "Claude", "last" : "Munoz" } }
{ "_id" : ObjectId("5ec4d4d0ec2b5adab4754de8"), "userKey" : "MILOWHIT5333", "name" : { "first" : "Milo", "last" : "Whitney" } }
{ "_id" : ObjectId("5ec4d4d0ec2b5adab4754de9"), "userKey" : "JARRKIM6948", "name" : { "first" : "Jarred", "last" : "Kim" } }
{ "_id" : ObjectId("5ec4d4d0ec2b5adab4754dea"), "userKey" : "HERMGILM2578", "name" : { "first" : "Herman", "last" : "Gilmore" } }
{ "_id" : ObjectId("5ec4d4d0ec2b5adab4754deb"), "userKey" : "ANASCHUN7156", "name" : { "first" : "Anastacia", "last" : "Chung" } }
{ "_id" : ObjectId("5ec4d4d0ec2b5adab4754dec"), "userKey" : "ODESLEAC7490", "name" : { "first" : "Odessa", "last" : "Leach" } }
{ "_id" : ObjectId("5ec4d4d0ec2b5adab4754ded"), "userKey" : "ADELBLAK2695", "name" : { "first" : "Adelia", "last" : "Blake" } }
{ "_id" : ObjectId("5ec4d4d0ec2b5adab4754dee"), "userKey" : "GERTVELA6336", "name" : { "first" : "Gertrude", "last" : "Velasquez" } }
{ "_id" : ObjectId("5ec4d4d0ec2b5adab4754def"), "userKey" : "FLETBARR1534", "name" : { "first" : "Fletcher", "last" : "Barron" } }
{ "_id" : ObjectId("5ec4d4d0ec2b5adab4754df0"), "userKey" : "YONBARR0402", "name" : { "first" : "Yon", "last" : "Barrett" } }
{ "_id" : ObjectId("5ec4d4d0ec2b5adab4754df1"), "userKey" : "SHAWTRAN4223", "name" : { "first" : "Shawna", "last" : "Tran" } }
{ "_id" : ObjectId("5ec4d4d0ec2b5adab4754df2"), "userKey" : "LUCISAND0674", "name" : { "first" : "Luciana", "last" : "Sandoval" } }
{ "_id" : ObjectId("5ec4d4d0ec2b5adab4754df3"), "userKey" : "RANDSTEV0697", "name" : { "first" : "Randell", "last" : "Stevenson" } }
Type "it" for more
>

```

```

File Edit View Search Terminal Help
> db.users.createIndex({"userKey":1},{unique:true});
{
  "createdCollectionAutomatically" : false,
  "numIndexesBefore" : 1,
  "numIndexesAfter" : 2,
  "ok" : 1
}
> db.users.insertOne({"userKey":"CHARROSS3456","name":{"first":"Fred","last":"Flintstone"}});
2020-05-21T05:11:26.543+0000 E QUERY [js] WriteError({
  "index" : 0,
  "code" : 11000,
  "errmsg" : "E11000 duplicate key error collection: biglittle.users index: userKey_1 dup key: { userKey: \"CHARROSS3456\" }",
  "op" : {
    "_id" : ObjectId("5ec60d7e0776678639c02dce"),
    "userKey" : "CHARROSS3456",
    "name" : {
      "first" : "Fred",
      "last" : "Flintstone"
    }
  }
}) :
WriteError({
  "index" : 0,
  "code" : 11000,
  "errmsg" : "E11000 duplicate key error collection: biglittle.users index: userKey_1 dup key: { userKey: \"CHARROSS3456\" }",
  "op" : {
    "_id" : ObjectId("5ec60d7e0776678639c02dce"),
    "userKey" : "CHARROSS3456",
    "name" : {
      "first" : "Fred",
      "last" : "Flintstone"
    }
  }
})
WriteError@src/mongo/shell/bulk_api.js:458:48
mergeBatchResults@src/mongo/shell/bulk_api.js:855:49
executeBatch@src/mongo/shell/bulk_api.js:919:13
Bulk/this.execute@src/mongo/shell/bulk_api.js:1163:21
DBCollection.prototype.insertOne@src/mongo/shell/crud_api.js:264:9
@(shell):1:1
>

```

```
File Edit View Search Terminal Help
root@server1:/repo/sample_data# ls -l /tmp/all*
-rw-r--r-- 1 root root 119200479 May 21 03:01 /tmp/allCountriesPostcodes.txt
-rw-r--r-- 1 root root 1551551316 May 21 02:48 /tmp/allCountriesStats.txt
root@server1:/repo/sample_data#
```

```
File Edit View Search Terminal Help
root@server1:/repo/sample_data# mongofiles --db=biglittle --local=/tmp/allCountriesPostcodes.txt
put /postalCodes/world_cities_codes.txt
2020-05-21T05:52:41.238+0000 connected to: mongodb://localhost/
2020-05-21T05:52:42.212+0000 added gridFile: /postalCodes/world_cities_codes.txt

root@server1:/repo/sample_data# mongofiles --db=biglittle list
2020-05-21T05:53:31.038+0000 connected to: mongodb://localhost/
/postalCodes/world_cities_codes.txt 119200479
root@server1:/repo/sample_data#
```



```
File Edit View Search Terminal Help
> show collections;
common
fs.chunks
fs.files
loans
users
world_cities
> db.fs.files.find().pretty();
{
  "_id" : ObjectId("5ec617294270dd1f9cea992c"),
  "length" : NumberLong(119200479),
  "chunkSize" : 261120,
  "uploadDate" : ISODate("2020-05-21T05:52:42.210Z"),
  "filename" : "/postalCodes/world_cities_codes.txt",
  "metadata" : {
    }
}
{
  "_id" : ObjectId("5ec6182e08597ebba8913889"),
  "length" : NumberLong(1551551316),
  "chunkSize" : 261120,
  "uploadDate" : ISODate("2020-05-21T05:57:17.948Z"),
  "filename" : "/statistics/world_cities_stats.txt",
  "metadata" : {
    }
}
>
```

Chapter 11: Administering MongoDB Security

```
File Edit View Search Terminal Help
ked@ked-VirtualBox:~$ sudo mongod --noauth --dbpath /var/lib/mongodb
[sudo] password for ked:
{"t":{"$date":"2020-05-24T07:03:43.044+01:00"},"s":"I", "c":"CONTROL", "id":23285, "ctx":"main","msg":
"Automatically disabling TLS 1.0, to force-enable TLS 1.0 specify --sslDisabledProtocols 'none'"}
{"t":{"$date":"2020-05-24T07:03:43.053+01:00"},"s":"W", "c":"ASIO", "id":22601, "ctx":"main","msg":
"No TransportLayer configured during NetworkInterface startup"}
{"t":{"$date":"2020-05-24T07:03:43.053+01:00"},"s":"I", "c":"NETWORK", "id":4648601, "ctx":"main","msg":
"Implicit TCP FastOpen unavailable. If TCP FastOpen is required, set tcpFastOpenServer, tcpFastOpenClient,
and tcpFastOpenQueueSize."}
{"t":{"$date":"2020-05-24T07:03:43.054+01:00"},"s":"I", "c":"STORAGE", "id":4615611, "ctx":"initandliste
n","msg":"MongoDB starting","attr":{"pid":2346,"port":27017,"dbPath":"/var/lib/mongodb","architecture":"64
-bit","host":"ked-VirtualBox"}}
{"t":{"$date":"2020-05-24T07:03:43.060+01:00"},"s":"I", "c":"CONTROL", "id":23403, "ctx":"initandliste
n","msg":"Build Info","attr":{"buildInfo":{"version":"4.4.0-rc5","gitVersion":"bbdf0a11d1c61be0760a829e827
99129beac7be0","opensslVersion":"OpenSSL 1.1.1 11 Sep 2018","modules":[],"allocator":"tcmalloc","environm
```

```
File Edit View Search Terminal Help
> db.adminCommand({shutdown:1});
{"t":{"$date":"2020-05-24T06:38:53.194Z"},"s":"I", "c":"NETWORK", "id":20125, "ctx":"js","msg":
"DBClientConnection failed to receive message from {getServerAddress} - {swm_getStatus}","attr":{"g
etServerAddress":"127.0.0.1:27017","swm_getStatus":"HostUnreachable: Connection closed by peer"}}
uncaught exception: Error: error doing query: failed: network error while attempting to run command
'shutdown' on host '127.0.0.1:27017' :
DB.prototype.runCommand@src/mongo/shell/db.js:169:19
DB.prototype.adminCommand@src/mongo/shell/db.js:187:12
@(shell):1:1
{"t":{"$date":"2020-05-24T06:38:53.205Z"},"s":"I", "c":"NETWORK", "id":20120, "ctx":"js","msg":
"Trying to reconnect","attr":{"connString":"127.0.0.1:27017 failed"}}
{"t":{"$date":"2020-05-24T06:38:53.206Z"},"s":"I", "c":"NETWORK", "id":20125, "ctx":"js","msg":
"DBClientConnection failed to receive message from {getServerAddress} - {swm_getStatus}","attr":{"g
etServerAddress":"127.0.0.1:27017","swm_getStatus":"HostUnreachable: Connection reset by peer"}}
{"t":{"$date":"2020-05-24T06:38:53.206Z"},"s":"I", "c":"NETWORK", "id":20121, "ctx":"js","msg":
"Reconnect attempt failed","attr":{"connString":"127.0.0.1:27017 failed","reason":""}}
>
```

```
File Edit View Search Terminal Help
# mongod.conf

storage:
  dbPath: /var/lib/mongod
  journal:
    enabled: true

systemLog:
  destination: file
  logAppend: true
  path: /var/log/mongod/mongod.log

net:
  port: 27017
  bindIp: 127.0.0.1

processManagement:
  timeZoneInfo: /usr/share/zoneinfo

security:
  authorization: enabled
```

```
File Edit View Search Terminal Help
● mongod.service - MongoDB Database Server
   Loaded: loaded (/lib/systemd/system/mongod.service; disabled; vendor preset: enabled)
   Active: failed (Result: exit-code) since Sun 2020-05-24 07:28:51 BST; 7s ago
     Docs: https://docs.mongodb.org/manual
   Process: 2963 ExecStart=/usr/bin/mongod --config /etc/mongod.conf (code=exited, status=14)
   Main PID: 2963 (code=exited, status=14)

May 24 07:28:50 ked-VirtualBox systemd[1]: mongod.service: Main process exited, code=killed, sta
May 24 07:28:50 ked-VirtualBox systemd[1]: mongod.service: Failed with result 'signal'.
May 24 07:28:50 ked-VirtualBox systemd[1]: Stopped MongoDB Database Server.
May 24 07:28:50 ked-VirtualBox systemd[1]: Started MongoDB Database Server.
May 24 07:28:51 ked-VirtualBox systemd[1]: mongod.service: Main process exited, code=exited, sta
May 24 07:28:51 ked-VirtualBox systemd[1]: mongod.service: Failed with result 'exit-code'.
lines 1-13/13 (END)
```

```
File Edit View Search Terminal Help
-rw----- 1 mongodb mongodb 20480 Dec 24 09:42 index-5-7500462118803848817.wt
-rw----- 1 mongodb mongodb 12288 May 24 07:28 index-6-6735730018938818569.wt
-rw----- 1 mongodb mongodb 20480 Nov 19 2019 index-7-3426497892779560040.wt
drwx----- 2 mongodb mongodb 4096 May 24 07:17 journal
-rw----- 1 mongodb mongodb 36864 May 24 07:28 _mdb_catalog.wt
-rw----- 1 mongodb mongodb 5 May 24 07:17 mongod.lock
-rw----- 1 mongodb mongodb 36864 May 24 07:28 sizeStorer.wt
-rw----- 1 mongodb mongodb 114 Aug 26 2019 storage.bson
-rw----- 1 mongodb mongodb 44 Aug 26 2019 WiredTiger
-rw----- 1 mongodb mongodb 4096 May 24 07:28 WiredTigerHS.wt
-rw----- 1 mongodb mongodb 21 Aug 26 2019 WiredTiger.lock
-rw----- 1 root root 1259 May 24 07:22 WiredTiger.turtle
-rw----- 1 mongodb mongodb 106496 May 24 07:28 WiredTiger.wt
ked@ked-VirtualBox:~/learn-mongodb$
```

```
File Edit View Search Terminal Help
ked@ked-VirtualBox:~$ sudo service mongod restart
ked@ked-VirtualBox:~$ mongo --quiet -u superMan -p password
{"t":{"$date":"2020-05-24T06:17:35.844Z"},"s":"I", "c":"NETWORK", "id":4648601, "ctx":
"main","msg":"Implicit TCP FastOpen unavailable. If TCP FastOpen is required, set tcpFas
tOpenServer, tcpFastOpenClient, and tcpFastOpenQueueSize."}
> show dbs;
admin          0.000GB
biglittle     0.000GB
config        0.000GB
local         0.000GB
sweetscomplete 0.002GB
test          0.000GB
>
```

```
File Edit View Search Terminal Help
ked@ked-VirtualBox:~$ mongo --quiet -u bgReader -p password --authenticationDatabase=biglittle
{"t":{"$date":"2020-05-24T06:18:31.717Z"},"s":"I", "c":"NETWORK", "id":4648601, "ctx":"main","
msg":"Implicit TCP FastOpen unavailable. If TCP FastOpen is required, set tcpFastOpenServer, tcp
FastOpenClient, and tcpFastOpenQueueSize."}
> use biglittle;
switched to db biglittle
> db.loans.findOne({},{"payments":0});
{
  "_id" : ObjectId("5dc4fd4722a7c0328fb3dcf1"),
  "loanKey" : "CLYDROJA7788_RUFULOZA8328_20190801",
  "borrowerKey" : "CLYDROJA7788",
  "lenderKey" : "RUFULOZA8328",
  "loanInfo" : {
    "principal" : NumberDecimal("18400.0000000000"),
    "numPayments" : 60,
    "annualRate" : NumberDecimal("6.77000000000000"),
    "effectiveRate" : NumberDecimal("0.00564166666666670"),
    "monthlyPymt" : NumberDecimal("362.348698431970")
  },
  "overpayment" : NumberDecimal("0")
}
>
```

```
File Edit View Search Terminal Help
> db.test.insertOne({"entry_date":"2020-06-01"});
uncaught exception: WriteCommandError({
  "ok" : 0,
  "errmsg" : "not authorized on biglittle to execute command { insert: \"test\", ordered:
true, lsid: { id: UUID(\"0a077bb7-99b9-45bf-8abc-4cda5034511d\") }, $db: \"biglittle\" }",
  "code" : 13,
  "codeName" : "Unauthorized"
}) :
WriteCommandError({
  "ok" : 0,
  "errmsg" : "not authorized on biglittle to execute command { insert: \"test\", ordered:
true, lsid: { id: UUID(\"0a077bb7-99b9-45bf-8abc-4cda5034511d\") }, $db: \"biglittle\" }",
  "code" : 13,
  "codeName" : "Unauthorized"
})
WriteCommandError@src/mongo/shell/bulk_api.js:417:48
executeBatch@src/mongo/shell/bulk_api.js:915:23
Bulk/this.execute@src/mongo/shell/bulk_api.js:1163:21
DBCollection.prototype.insertOne@src/mongo/shell/crud_api.js:264:9
@(shell):1:1
>
```

```
File Edit View Search Terminal Help
ked@ked-VirtualBox:~$ mongo --quiet -u rwAll -p password
{"t":{"$date":"2020-05-24T05:33:20.762Z"},"s":"I", "c":"NETWORK", "id":4648601, "ctx":"main",
,"msg":"Implicit TCP FastOpen unavailable. If TCP FastOpen is required, set tcpFastOpenServer,
tcpFastOpenClient, and tcpFastOpenQueueSize."}
> use sweetscomplete;
switched to db sweetscomplete
> db.test.insertOne({"entry_date" : "2020-06-01"});
{
  "acknowledged" : true,
  "insertedId" : ObjectId("5eca072564c988ab5175ec28")
}
>
> use biglittle;
switched to db biglittle
> db.users.findOne({}, {"name":1});
{
  "_id" : ObjectId("5dc4fd41541e1aa5a62f7bbb"),
  "name" : {
    "title" : "Ms",
    "first" : "Charisse",
    "middle" : "X",
    "last" : "Ross",
    "suffix" : null
  }
}
>
```

```
root@server1: /repo/chapters/11
root@server1:/repo/chapters/11# mongod -f /etc/mongod.conf &
[1] 462
root@server1:/repo/chapters/11# mongo
MongoDB shell version v4.4.0-rc13
connecting to: mongod://127.0.0.1:27017/?compressors=disabled&gssapiServiceName=mongod
Error: network error while attempting to run command 'isMaster' on host '127.0.0.1:27017' :
connect@src/mongo/shell/mongo.js:362:17
@(connect):2:6
exception: connect failed
exiting with code 1
root@server1:/repo/chapters/11#
```

```
root@server1: /repo/chapters/11
root@server1:/repo/chapters/11# mongo --tls --tlsCertificateKeyFile /etc/.certs/client.pem
--tlsCAFile /etc/.certs/ca.pem --host server1 --quiet
> show dbs;
admin          0.000GB
biglittle      0.003GB
booksomeplace  0.005GB
config         0.000GB
local          0.000GB
sweetscomplete 0.002GB
>
```

Chapter 12: Developing in a Secured Environment

```
File Edit View Search Terminal Help
ked@ked-VirtualBox:~$ mongo --quiet -u superMan -p
{"t":{"$date":"2020-05-29T00:56:43.606Z"},"s":"I", "c":"NETWORK", "id":4648601, "ctx":"main","msg":"Implicit TCP FastOpen unavailable. If TCP FastOpen is required, set tcpFastOpenServer, tcpFastOpenClient, and tcpFastOpenQueueSize."}
Enter password:
> show dbs;
admin            0.000GB
biglittle        0.000GB
config           0.000GB
local            0.000GB
sweetscomplete  0.002GB
test             0.000GB
>
```

```
File Edit View Search Terminal Help
> doc = {
...   user: "biglittle_reader",
...   pwd: passwordPrompt(),
...   roles: [ { role: "read", db: "biglittle" } ],
...   authenticationRestrictions: [
...     {
...       clientSource: ["127.0.0.1"],
...       serverAddress: ["127.0.0.1"]
...     }
...   ],
...   mechanisms: [ "SCRAM-SHA-256" ],
...   passwordDigestor: "server"
... }
Enter password: █
```

```
File Edit View Search Terminal Help
> db.createUser(doc);
Successfully added user: {
  "user" : "biglittle_reader",
  "roles" : [
    {
      "role" : "read",
      "db" : "biglittle"
    }
  ],
  "authenticationRestrictions" : [
    {
      "clientSource" : [
        "127.0.0.1"
      ],
      "serverAddress" : [
        "127.0.0.1"
      ]
    }
  ],
  "mechanisms" : [
    "SCRAM-SHA-256"
  ],
  "passwordDigestor" : "server"
}
> █
```



```
File Edit View Search Terminal Help
ked@ked-VirtualBox:~/Learn-mongodb/chapters/12$ python3 test_read_no_auth.py
Traceback (most recent call last):
  File "test_read_no_auth.py", line 11, in <module>
    find_result = client.biglittle.users.find_one({}, {"name":1,"address":1})
  File "/home/ked/.local/lib/python3.6/site-packages/pymongo/collection.py", line 1273, in find_one
    for result in cursor.limit(-1):
  File "/home/ked/.local/lib/python3.6/site-packages/pymongo/cursor.py", line 1156, in next
    if len(self.__data) or self._refresh():
  File "/home/ked/.local/lib/python3.6/site-packages/pymongo/cursor.py", line 1073, in _refresh
    self.__send_message(q)
  File "/home/ked/.local/lib/python3.6/site-packages/pymongo/cursor.py", line 955, in _send_message
    address=self.__address)
  File "/home/ked/.local/lib/python3.6/site-packages/pymongo/mongo_client.py", line 1346, in _run_operation_with_response
    exhaust=exhaust)
  File "/home/ked/.local/lib/python3.6/site-packages/pymongo/mongo_client.py", line 1464, in _retryable_read
    return func(session, server, sock info, slave ok)
  File "/home/ked/.local/lib/python3.6/site-packages/pymongo/mongo_client.py", line 1340, in _cmd
    unpack_res)
  File "/home/ked/.local/lib/python3.6/site-packages/pymongo/server.py", line 136, in run_operation_with_response
    check_command_response(first)
  File "/home/ked/.local/lib/python3.6/site-packages/pymongo/helpers.py", line 159, in _check_command_response
    raise OperationFailure(msg % errmsg, code, response)
pymongo.errors.OperationFailure: command find requires authentication
ked@ked-VirtualBox:~/Learn-mongodb/chapters/12$
```

```
File Edit View Search Terminal Help
ked@ked-VirtualBox:~/Learn-mongodb/chapters/12$ python3 test_read_with_auth.py
Find Result:
{'_id': ObjectId('5dc4fd41541e1aa5a62f7bbb'),
 'address': {'buildingName': None,
             'city': 'Gadhail',
             'country': 'GB',
             'floor': None,
             'geoSpatial': ['-5.9556', '56.5056'],
             'locality1': 'Scotland',
             'locality2': 'Argyll and Bute',
             'postalCode': 'PA72',
             'roomAptCondoFlat': None,
             'streetAddress': '1790 Short Woods Circle'},
 'name': {'first': 'Charisse',
          'last': 'Ross',
          'middle': 'X',
          'suffix': None,
          'title': 'Ms'}}
```

```
File Edit View Search Terminal Help
ked@ked-VirtualBox:~/learn-mongodb/chapters/12$ python3 test_read_write_biglittle.py

Insert Result:
<pymongo.results.InsertOneResult object at 0x7fb1df1749c8>

Find Result:
{'_id': ObjectId('5df46013069247257698cad0'),
 'first_name': 'Fred',
 'last_name': 'Flintstone'}
ked@ked-VirtualBox:~/learn-mongodb/chapters/12$ █
```

```
File Edit View Search Terminal Help
pymongo.errors.OperationFailure: not authorized on sweetscomplete to execute command { delete:
"test_collection", ordered: true, lsid: { id: UUID("93dd48b7-a61e-44dd-8095-49743fece532") },
$db: "sweetscomplete", $readPreference: { mode: "primary" } }
ked@ked-VirtualBox:~/learn-mongodb/chapters/12$ python3 test_read_write_sweetscomplete.py █
```

```
File Edit View Search Terminal Help
ked@ked-VirtualBox:~/learn-mongodb/chapters/12$ python3 test_read_all.py
Find Result:
{'_id': ObjectId('5dc4fd41541e1aa5a62f7bbb'),
 'address': {'buildingName': None,
             'city': 'Gaothail',
             'country': 'GB',
             'floor': None,
             'geoSpatial': ['-5.9556', '56.5056'],
             'locality1': 'Scotland',
             'locality2': 'Argyll and Bute',
             'postalCode': 'PA72',
             'roomAptCondoFlat': None,
             'streetAddress': '1790 Short Woods Circle'},
 'name': {'first': 'Charisse',
          'last': 'Ross',
          'middle': 'X',
          'suffix': None,
          'title': 'Ms'}}
{'_id': ObjectId('5dd36806834d9fa421215dc4'),
 'city': 'Washington',
 'country': 'US',
 'firstName': 'Patrina',
 'lastName': 'Yoder',
 'locality': 'District of Columbia'}
ked@ked-VirtualBox:~/learn-mongodb/chapters/12$ █
```

```
File Edit View Search Terminal Help
Number of Documents: 230
{'avgObjSize': 5843,
 'capped': False,
 'count': 230,
 'indexBuilds': [],
 'indexDetails': {'_id': {'LSM': {'bloom filter false positives': 0,
                                   'bloom filter hits': 0,
                                   'bloom filter misses': 0,
                                   'bloom filter pages evicted from cache': 0,
                                   'bloom filter pages read into cache': 0,
                                   'bloom filters in the LSM tree': 0,
                                   'chunks in the LSM tree': 0,
                                   'highest merge generation in the LSM tree': 0,
                                   'queries that could have benefited from a Bloom filter that did not exist': 0,
                                   'sleep for LSM checkpoint throttle': 0,
                                   'sleep for LSM merge throttle': 0,
                                   'total size of bloom filters': 0},
                    'block-manager': {'allocations requiring file extension': 0,
                                       'blocks allocated': 0,
                                       'blocks freed': 0,
                                       'checkpoint size': 4096,
                                       'file allocation unit size': 4096,
                                       'file bytes available for reuse': 0,
                                       'file magic number': 120897,
                                       'file major version number': 1,
                                       'file size in bytes': 20480,
                                       'minor version number': 0},
                    'btree': {'btree checkpoint generation': 9,
                              'column-store fixed-size leaf pages': 0,
                              'column-store internal pages': 0,
                              'column-store variable-size RLE encoded values': 0,
                              'column-store variable-size deleted values': 0,
                              'column-store variable-size leaf pages': 0,
                              'fixed-record size': 0,
```

```
File Edit View Search Terminal Help
ked@ked-VirtualBox:~/Learn-mongodb/chapters/12$ python3 test_db_admin.py "read_user_test_1" "password" "r"
Result:
{'ok': 1.0}
ked@ked-VirtualBox:~/Learn-mongodb/chapters/12$ █
```

```
> use admin;
switched to db admin
> db.system.users.findOne({"user":"read_user_test_1"});
{
  "_id" : "biglittle.read_user_test_1",
  "userId" : UUID("d9f78179-a955-42e7-a5f7-fb46c5ec77f8"),
  "user" : "read_user_test_1",
  "db" : "biglittle",
  "credentials" : {
    "SCRAM-SHA-256" : {
      "iterationCount" : 15000,
      "salt" : "8q28TecdhBxBGjwCc7lKcPMTcQAvRzmr26Tu8Q==",
      "storedKey" : "9dNge/GWIJQglfkE0qsWzDdltcvBkTU+FE+IhnJ77Zg=",
      "serverKey" : "X9GSszNrjASyv/4c40P7tu3AbMVAos/317S3ZI1UvdY="
    }
  },
  "roles" : [
    {
      "role" : "read",
      "db" : "biglittle"
    }
  ]
}
```

```
File Edit View Search Terminal Help
ked@ked-VirtualBox:~/learn-mongodb/chapters/12$ python3 test_read_all_tls.py

Find Result:
{'_id': ObjectId('5dc4fd41541e1aa5a62f7bbb'),
 'address': {'buildingName': None,
             'city': 'Gaothail',
             'country': 'GB',
             'floor': None,
             'geoSpatial': ['-5.9556', '56.5056'],
             'locality1': 'Scotland',
             'locality2': 'Argyll and Bute',
             'postalCode': 'PA72',
             'roomAptCondoFlat': None,
             'streetAddress': '1790 Short Woods Circle'},
 'name': {'first': 'Charisse',
          'last': 'Ross',
          'middle': 'X',
          'suffix': None,
          'title': 'Ms'}}
ked@ked-VirtualBox:~/learn-mongodb/chapters/12$ █
```

Chapter 13: Deploying a Replica Set

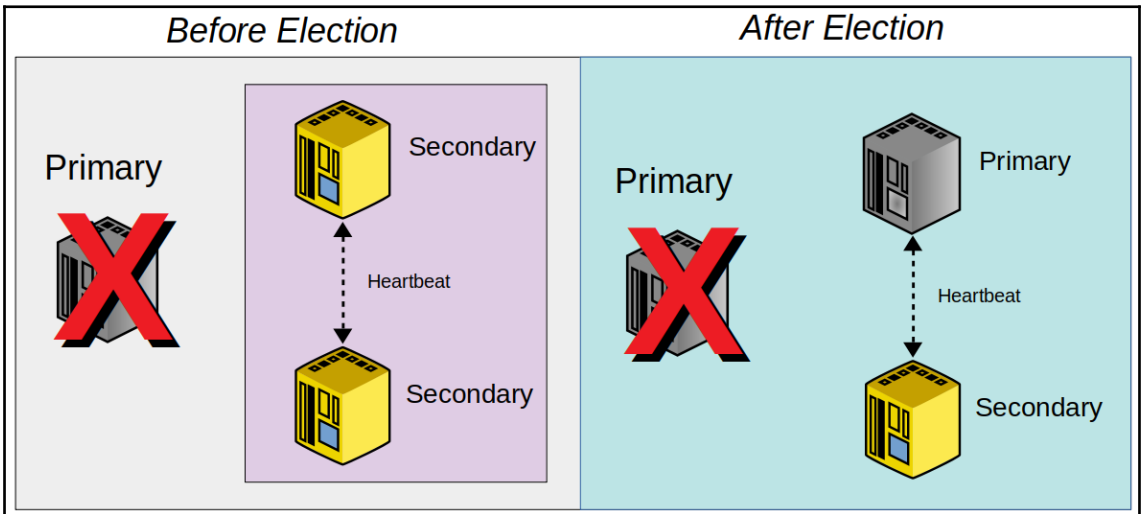
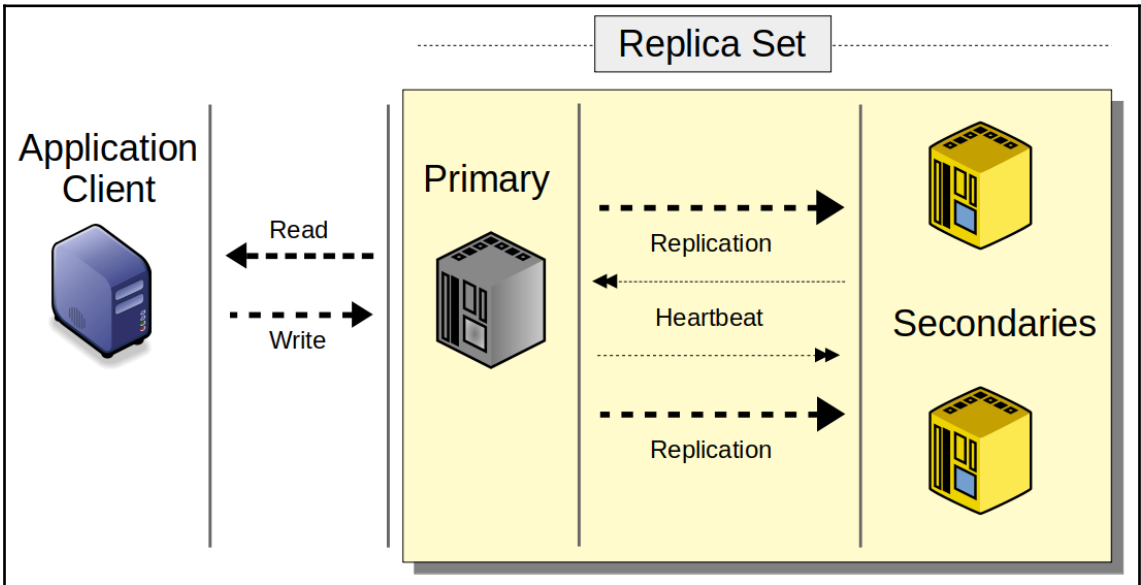

```
File Edit View Search Terminal Help
jed@jed:~/Repos/learn-mongodb/chapters/13$ docker-compose up
Starting learn-mongo-member-3 ... done
Starting learn-mongo-member-1 ... done
Starting learn-mongo-member-2 ... done
Attaching to learn-mongo-member-3, learn-mongo-member-1, learn-mongo-member-2
```

```
File Edit View Search Terminal Help
jed@jed:~/Repos/learn-mongodb/chapters/13$ ./verify_connections.sh
PING member2.biglittle.local (172.16.0.22): 56 data bytes
64 bytes from 172.16.0.22: icmp_seq=0 ttl=64 time=0.083 ms
--- member2.biglittle.local ping statistics ---
1 packets transmitted, 1 packets received, 0% packet loss
round-trip min/avg/max/stddev = 0.083/0.083/0.083/0.000 ms
PING member3.biglittle.local (172.16.0.33): 56 data bytes
64 bytes from 172.16.0.33: icmp_seq=0 ttl=64 time=0.083 ms
--- member3.biglittle.local ping statistics ---
1 packets transmitted, 1 packets received, 0% packet loss
round-trip min/avg/max/stddev = 0.083/0.083/0.083/0.000 ms
PING member1.biglittle.local (172.16.0.11): 56 data bytes
64 bytes from 172.16.0.11: icmp_seq=0 ttl=64 time=0.084 ms
--- member1.biglittle.local ping statistics ---
1 packets transmitted, 1 packets received, 0% packet loss
round-trip min/avg/max/stddev = 0.084/0.084/0.084/0.000 ms
jed@jed:~/Repos/learn-mongodb/chapters/13$
```

```
File Edit View Search Terminal Help
jed@jed:~$ docker exec -it learn-mongo-member-1 /bin/bash -c "cat /etc/mongod.conf"
systemLog:
  destination: file
  path: "/var/log/mongodb/mongod.log"
  logAppend: true
storage:
  dbPath: "/data/db"
  journal:
    enabled: true
net:
  bindIp: 0.0.0.0
  port: 27017
replication:
  replSetName: learn_mongodb
jed@jed:~$
```



```
File Edit View Search Terminal Help
jed@jed:~/Repos/learn-mongodb/chapters/13$ docker-compose up
Starting learn-mongo-member-3 ... done
Starting learn-mongo-member-1 ... done
Starting learn-mongo-member-2 ... done
Attaching to learn-mongo-member-3, learn-mongo-member-1, learn-mongo-member-2
```

```
File Edit View Search Terminal Help
> rs.initiate(doc);
{
  "ok" : 1,
  "$clusterTime" : {
    "clusterTime" : Timestamp(1585109854, 1),
    "signature" : {
      "hash" : BinData(0,"AAAAAAAAAAAAAAAAAAAAAAAAAAAA="),
      "keyId" : NumberLong(0)
    }
  },
  "operationTime" : Timestamp(1585109854, 1)
}
learn_mongodb:SECONDARY>
```

```
File Edit View Search Terminal Help
learn_mongodb:PRIMARY> rs.status();
{
  "set" : "learn_mongodb",
  "date" : ISODate("2020-03-25T05:29:35.815Z"),
  "myState" : 1,
  "term" : NumberLong(1),
  "syncingTo" : "",
  "syncSourceHost" : "",
  "syncSourceId" : -1,
  "heartbeatIntervalMillis" : NumberLong(2000),
  "majorityVoteCount" : 2,
  "writeMajorityCount" : 2,
  "optimes" : {
    "lastCommittedOpTime" : {
      "ts" : Timestamp(1585114168, 1),
      "t" : NumberLong(1)
    },
    "lastCommittedWallTime" : ISODate("2020-03-25T05:29:28.209Z"),
    "readConcernMajorityOpTime" : {
```

```
File Edit View Search Terminal Help
```

```
learn_mongodb:PRIMARY> show dbs;
admin          0.000GB
biglittle      0.000GB
config         0.000GB
local          0.001GB
learn_mongodb:PRIMARY> use biglittle;
switched to db biglittle
learn_mongodb:PRIMARY> show collections;
common
loans
users
learn_mongodb:PRIMARY> db.loans.find().count();
230
learn_mongodb:PRIMARY>
```

```
File Edit View Search Terminal Help
learn_mongodb:SECONDARY> rs.slaveOk();
learn_mongodb:SECONDARY> show dbs;
admin    0.000GB
config  0.000GB
local    0.000GB
learn_mongodb:SECONDARY> show dbs;
admin      0.000GB
biglittle  0.000GB
config     0.000GB
local      0.001GB
learn_mongodb:SECONDARY> use biglittle;
switched to db biglittle
learn_mongodb:SECONDARY> show collections;
common
loans
users
learn_mongodb:SECONDARY> db.loans.find().count();
230
learn_mongodb:SECONDARY>
```

Chapter 14: Replica Set Runtime Management and Development

```
File Edit View Search Terminal Help
learn_mongodb:SECONDARY> use local;
switched to db local
learn_mongodb:SECONDARY> db.oplog.rs.stats().maxSize;
NumberLong("4676677376")
learn_mongodb:SECONDARY> current = db.oplog.rs.stats().maxSize;
NumberLong("4676677376")
learn_mongodb:SECONDARY> db.adminCommand({replSetResizeOplog: 1, size: current*2/1000000});
{
  "ok" : 1,
  "$clusterTime" : {
    "clusterTime" : Timestamp(1585194951, 1),
    "signature" : {
      "hash" : BinData(0,"AAAAAAAAAAAAAAAAAAAAAAAAAAAAAAAA="),
      "keyId" : NumberLong(0)
    }
  },
  "operationTime" : Timestamp(1585194951, 1)
}
learn_mongodb:SECONDARY> db.oplog.rs.stats().maxSize;
NumberLong("9807331328")
learn_mongodb:SECONDARY>
```

```
File Edit View Search Terminal Help

"members" : [
  {
    "_id" : 1,
    "name" : "member1.biglittle.local:27017",
    "health" : 0,
    "state" : 8,
    "stateStr" : "(not reachable/healthy)",
    "uptime" : 0,
    "optime" : {
      "ts" : Timestamp(0, 0),
      "t" : NumberLong(-1)
    },
    "optimeDurable" : {
      "ts" : Timestamp(0, 0),
      "t" : NumberLong(-1)
    },
    "optimeDate" : ISODate("1970-01-01T00:00:00Z"),
    "optimeDurableDate" : ISODate("1970-01-01T00:00:00Z"),
    "lastHeartbeat" : ISODate("2020-03-28T03:55:48.165Z"),
    "lastHeartbeatRecv" : ISODate("2020-03-28T03:55:18.883Z"),
    "pingMs" : NumberLong(0),
    "lastHeartbeatMessage" : "Couldn't get a connection within the time limit",
    "syncingTo" : "",
    "syncSourceHost" : "",
    "syncSourceId" : -1,
    "infoMessage" : "",
    "configVersion" : -1
  },
],
```

```
File Edit View Search Terminal Help

learn_mongodb:PRIMARY> rs.printReplicationInfo();
configured oplog size: 4460.0146484375MB
log length start to end: 85575secs (23.77hrs)
oplog first event time: Wed Mar 25 2020 04:40:36 GMT+0000 (UTC)
oplog last event time: Thu Mar 26 2020 04:26:51 GMT+0000 (UTC)
now: Thu Mar 26 2020 04:26:57 GMT+0000 (UTC)
learn_mongodb:PRIMARY>
```

```
File Edit View Search Terminal Help
learn_mongodb:PRIMARY> rs.printSlaveReplicationInfo();
source: member1.biglittle.local:27017
    syncedTo: Thu Mar 26 2020 04:27:21 GMT+0000 (UTC)
    0 secs (0 hrs) behind the primary
source: member3.biglittle.local:27017
    syncedTo: Thu Mar 26 2020 04:27:21 GMT+0000 (UTC)
    0 secs (0 hrs) behind the primary
learn_mongodb:PRIMARY>
```

```
File Edit View Search Terminal Help
root@member2:/# mkdir /data/common/backup
root@member2:/# mongodump --oplog --out=/data/common/backup --uri="mongodb://member1.biglittle.local,member2.biglittle.local,member1.biglittle.local/?replicaSet=learn_mongodb"
2020-03-28T03:04:44.305+0000    writing admin.system.version to
2020-03-28T03:04:44.308+0000    done dumping admin.system.version (1 document)
2020-03-28T03:04:44.315+0000    writing biglittle.loans to
2020-03-28T03:04:44.318+0000    writing biglittle.users to
2020-03-28T03:04:44.321+0000    writing biglittle.common to
2020-03-28T03:04:44.338+0000    done dumping biglittle.users (289 documents)
2020-03-28T03:04:44.338+0000    done dumping biglittle.common (8 documents)
2020-03-28T03:04:44.354+0000    done dumping biglittle.loans (230 documents)
2020-03-28T03:04:44.356+0000    writing captured oplog to
2020-03-28T03:04:44.357+0000        dumped 1 oplog entry
root@member2:/#
```

```
File Edit View Search Terminal Help
learn_mongodb:PRIMARY> rs.status().members;
[
  {
    "_id" : 1,
    "name" : "member1.biglittle.local:27017",
    "health" : 1,
    "state" : 1,
    "stateStr" : "PRIMARY",
    "uptime" : 69,
    "optime" : {
      "ts" : Timestamp(1585371093, 1),
      "t" : NumberLong(1)
    },
    "optimeDate" : ISODate("2020-03-28T04:51:33Z"),
    "syncingTo" : "",
    "syncSourceHost" : "",
    "syncSourceId" : -1,
    "infoMessage" : "could not find member to sync from",
    "electionTime" : Timestamp(1585371042, 2),
    "electionDate" : ISODate("2020-03-28T04:50:42Z"),
    "configVersion" : 1,
    "self" : true,
    "lastHeartbeatMessage" : ""
  }
]
learn_mongodb:PRIMARY>
```

```

File Edit View Search Terminal Help
learn_mongodb:PRIMARY> member2 = { _id: 2, host: "member2.biglittle.local" }
{ "_id" : 2, "host" : "member2.biglittle.local" }
learn_mongodb:PRIMARY> rs.add(member2);
{
  "ok" : 1,
  "$clusterTime" : {
    "clusterTime" : Timestamp(1585373004, 1),
    "signature" : {
      "hash" : BinData(0,"AAAAAAAAAAAAAAAAAAAAAAAAAAAA="),
      "keyId" : NumberLong(0)
    }
  },
  "operationTime" : Timestamp(1585373004, 1)
}
learn_mongodb:PRIMARY>

```

```

File Edit View Search Terminal Help
jed@jed:~/Repos/Learn-mongodb/chapters/13$ python test_replica_set_connect_using_one_server.py
{'_id': ObjectId('5e7ae2d344defb0ed1a92185'),
 'address': {'buildingName': None,
             'city': 'Gaothail',
             'country': 'GB',
             'floor': None,
             'geoSpatial': ['-5.9556', '56.5056'],
             'locality1': 'Scotland',
             'locality2': 'Argyll and Bute',
             'postalCode': 'PA72',
             'roomAptCondoFlat': None,
             'streetAddress': '1790 Short Woods Circle'},
 'businessName': 'Green Associates Company'}
jed@jed:~/Repos/Learn-mongodb/chapters/13$

```

```

File Edit View Search Terminal Help
jed@jed:~/Repos/Learn-mongodb/chapters/13$ python test_replica_set_connect_using_list.py
{'_id': ObjectId('5e7ae2d344defb0ed1a92185'),
 'address': {'buildingName': None,
             'city': 'Gaothail',
             'country': 'GB',
             'floor': None,
             'geoSpatial': ['-5.9556', '56.5056'],
             'locality1': 'Scotland',
             'locality2': 'Argyll and Bute',
             'postalCode': 'PA72',
             'roomAptCondoFlat': None,
             'streetAddress': '1790 Short Woods Circle'},
 'businessName': 'Green Associates Company'}
jed@jed:~/Repos/Learn-mongodb/chapters/13$

```

Chapter 15: Deploying a Sharded Cluster

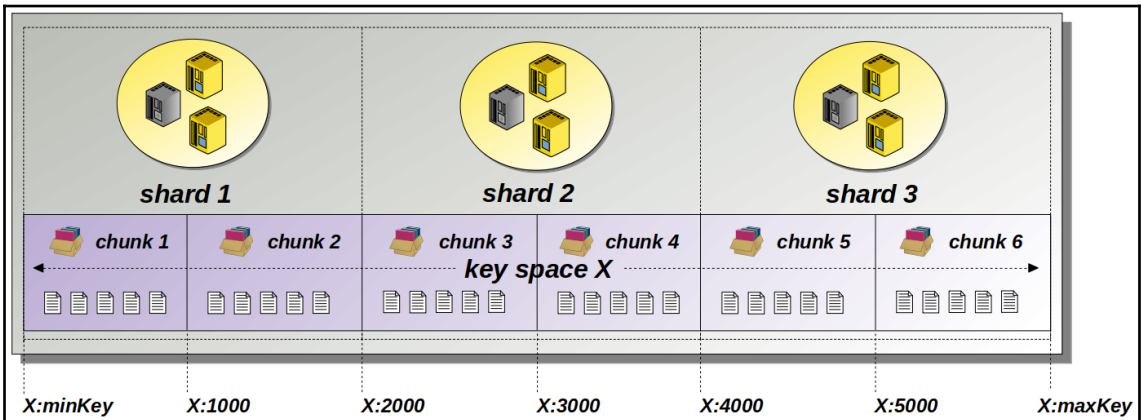
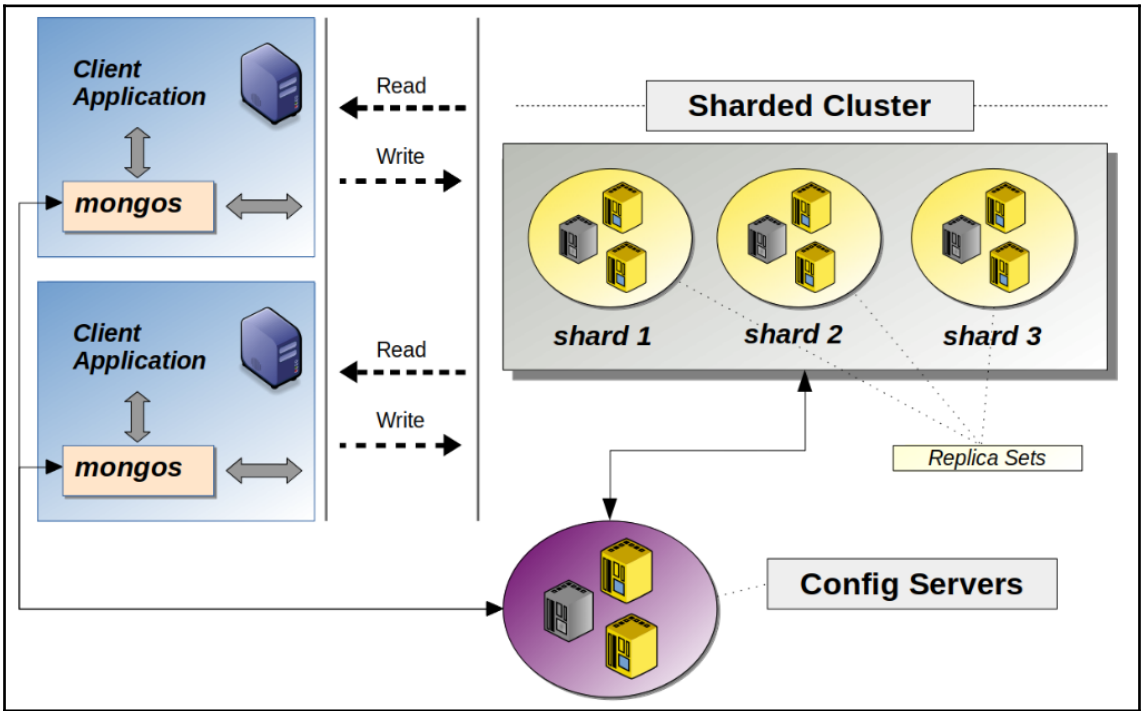

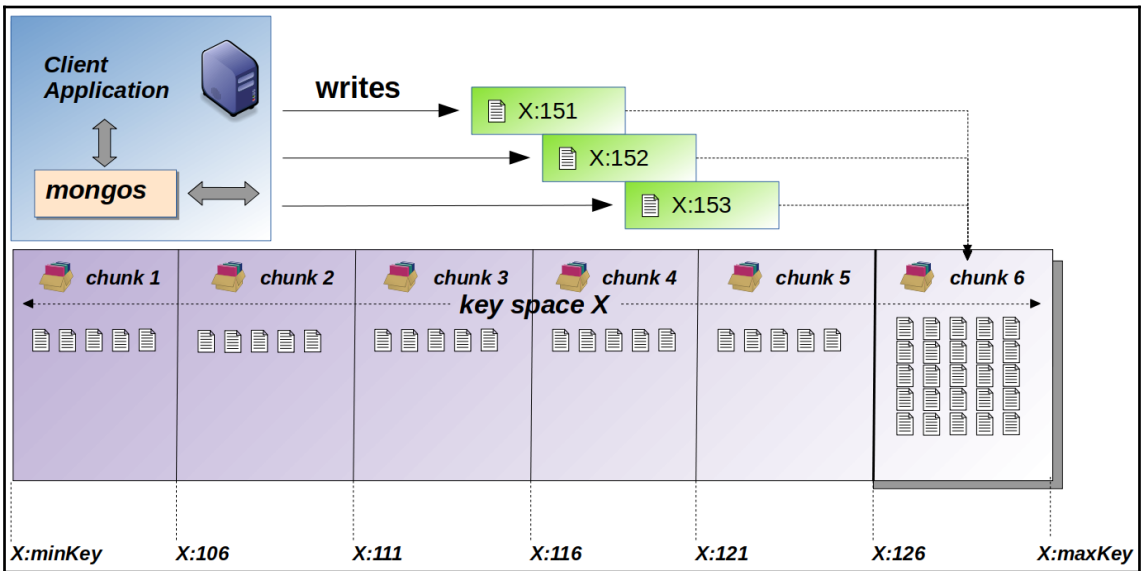
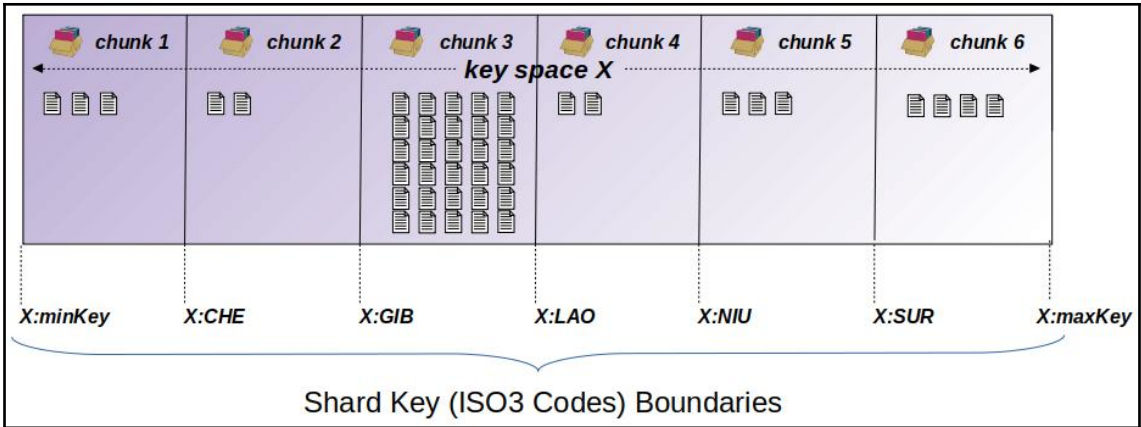

```

File Edit View Search Terminal Help
jed@jed:~/Repos/Learn-mongodb/chapters/14$ docker-compose up
Starting learn-mongo-mongos ... done
Starting learn-mongo-shard-3 ... done
Starting learn-mongo-shard-1 ... done
Starting learn-mongo-config ... done
Starting learn-mongo-shard-2 ... done
Attaching to learn-mongo-shard-1, learn-mongo-shard-3, learn-mongo-mongos, learn-mongo-shard-2, learn-mongo-config
learn-mongo-mongos | 2020-04-07T08:30:16.697+0000 W SHARDING [main] Running a sharded cluster with fewer
than 3 config servers should only be done for testing purposes and is not recommended for production.

```

```
File Edit View Search Terminal Help
jed@jed:~/Repos/learn-mongodb/chapters/14$ ./verify_connections.sh
PING shard2.biglittle.local (172.16.1.22): 56 data bytes
64 bytes from 172.16.1.22: icmp_seq=0 ttl=64 time=0.120 ms
--- shard2.biglittle.local ping statistics ---
1 packets transmitted, 1 packets received, 0% packet loss
round-trip min/avg/max/stddev = 0.120/0.120/0.120/0.000 ms
PING shard3.biglittle.local (172.16.1.33): 56 data bytes
64 bytes from 172.16.1.33: icmp_seq=0 ttl=64 time=0.113 ms
--- shard3.biglittle.local ping statistics ---
1 packets transmitted, 1 packets received, 0% packet loss
round-trip min/avg/max/stddev = 0.113/0.113/0.113/0.000 ms
PING config1.biglittle.local (172.16.1.44): 56 data bytes
64 bytes from 172.16.1.44: icmp_seq=0 ttl=64 time=0.111 ms
--- config1.biglittle.local ping statistics ---
1 packets transmitted, 1 packets received, 0% packet loss
round-trip min/avg/max/stddev = 0.111/0.111/0.111/0.000 ms
PING mongos1.biglittle.local (172.16.1.55): 56 data bytes
64 bytes from 172.16.1.55: icmp_seq=0 ttl=64 time=0.082 ms
--- mongos1.biglittle.local ping statistics ---
1 packets transmitted, 1 packets received, 0% packet loss
round-trip min/avg/max/stddev = 0.082/0.082/0.082/0.000 ms
PING shard1.biglittle.local (172.16.1.11): 56 data bytes
64 bytes from 172.16.1.11: icmp_seq=0 ttl=64 time=0.166 ms
--- shard1.biglittle.local ping statistics ---
1 packets transmitted, 1 packets received, 0% packet loss
round-trip min/avg/max/stddev = 0.166/0.166/0.166/0.000 ms
jed@jed:~/Repos/learn-mongodb/chapters/14$
```

```

File Edit View Search Terminal Help
root@config1:/# mongo --port 27019 --quiet
> doc = {
...   _id : "repl_config",
...   members: [
...     { _id: 1, host: "config1.biglittle.local:27019" }
...   ]
... }
{
  "_id" : "repl_config",
  "members" : [
    {
      "_id" : 1,
      "host" : "config1.biglittle.local:27019"
    }
  ]
}
> rs.initiate(doc);
{
  "ok" : 1,
  "$gleStats" : {
    "lastOpTime" : Timestamp(1586315206, 1),
    "electionId" : ObjectId("000000000000000000000000")
  },
  "lastCommittedOpTime" : Timestamp(0, 0),
  "$clusterTime" : {
    "clusterTime" : Timestamp(1586315206, 1),
    "signature" : {
      "hash" : BinData(0,"AAAAAAAAAAAAAAAAAAAAAAAAAAAAAAAA="),
      "keyId" : NumberLong(0)
    }
  },
  "operationTime" : Timestamp(1586315206, 1)
}
repl_config:SECONDARY>
repl_config:PRIMARY>

```

```
File Edit View Search Terminal Help
root@mongos1:/# mongos -f /etc/mongos.conf
2020-04-08T03:32:31.468+0000 W SHARDING [main] Running a sharded cluster with fewer than 3 config servers should only be done for testing purposes and is not recommended for production.
root@mongos1:/# ps -ax
  PID TTY          STAT TIME COMMAND
    1 ?           Ssl   0:04 mongos -f /etc/mongos.conf
   40 pts/0        Ss    0:00 /bin/bash
   55 pts/0        R+    0:00 ps -ax
root@mongos1:/#
```

```
File Edit View Search Terminal Help
root@mongos1:/# mongo --port 27020 --quiet
Welcome to the MongoDB shell.
For interactive help, type "help".
For more comprehensive documentation, see
    http://docs.mongodb.org/
Questions? Try the support group
    http://groups.google.com/group/mongodb-user
mongos>
```

```
File Edit View Search Terminal Help
jed@jed:~$ docker exec -it learn-mongo-mongos /bin/bash
root@mongos1:/# mongo --port 27020 --quiet
Welcome to the MongoDB shell.
For interactive help, type "help".
For more comprehensive documentation, see
  http://docs.mongodb.org/
Questions? Try the support group
  http://groups.google.com/group/mongodb-user
mongos> sh.addShard("repl_shard_1/shard1.biglittle.local:27018");
{
  "shardAdded" : "repl_shard_1",
  "ok" : 1,
  "operationTime" : Timestamp(1586407231, 1),
  "$clusterTime" : {
    "clusterTime" : Timestamp(1586407231, 1),
    "signature" : {
      "hash" : BinData(0,"AAAAAAAAAAAAAAAAAAAAAAAAAAAAAAAA="),
      "keyId" : NumberLong(0)
    }
  }
}
mongos>
```

```
File Edit View Search Terminal Help
mongos> sh.enableSharding("biglittle");
{
  "ok" : 1,
  "operationTime" : Timestamp(1586407897, 3),
  "$clusterTime" : {
    "clusterTime" : Timestamp(1586407897, 3),
    "signature" : {
      "hash" : BinData(0,"AAAAAAAAAAAAAAAAAAAAAAAAAAAAAAAA="),
      "keyId" : NumberLong(0)
    }
  }
}
mongos>
```

```

File Edit View Search Terminal Help
mongos> sh.status();
--- Sharding Status ---
  sharding version: {
    "_id" : 1,
    "minCompatibleVersion" : 5,
    "currentVersion" : 6,
    "clusterId" : ObjectId("5e8d3fc8e5189742de6075e2")
  }
  shards:
    { "_id" : "repl_shard_1", "host" : "repl_shard_1/shard1.biglittle.local:27018", "state" : 1 }
    { "_id" : "repl_shard_2", "host" : "repl_shard_2/shard2.biglittle.local:27018", "state" : 1 }
    { "_id" : "repl_shard_3", "host" : "repl_shard_3/shard3.biglittle.local:27018", "state" : 1 }
  active mongoses:
    "4.2.5" : 1
  autosplit:
    Currently enabled: yes
  balancer:
    Currently enabled: yes
    Currently running: no
    Failed balancer rounds in last 5 attempts: 0
    Migration Results for the last 24 hours:
      No recent migrations
  databases:
    { "_id" : "biglittle", "primary" : "repl_shard_1", "partitioned" : true, "version" : { "uuid" :
    UUID("a58f2a69-dcca-4d1d-9f06-0f833e82e64f"), "lastMod" : 1 } }
    { "_id" : "config", "primary" : "config", "partitioned" : true }
      config.system.sessions
        shard key: { "_id" : 1 }
        unique: false
        balancing: true
        chunks:
          repl_shard_1 1
          { "_id" : { "$minKey" : 1 } } --> { "_id" : { "$maxKey" : 1 } } on : repl_shard_1 Ti
mestamp(1, 0)
mongos>

```

```
File Edit View Search Terminal Help
mongos> collection = "biglittle.world_cities";
biglittle.world_cities
mongos> shardKey = { "timezone" : 1 };
{ "timezone" : 1 }
mongos> sh.shardCollection(collection, shardKey);
{
  "collectionsharded" : "biglittle.world_cities",
  "collectionUUID" : UUID("280bf009-a166-46e5-9d34-64cf65d14835"),
  "ok" : 1,
  "operationTime" : Timestamp(1586502478, 9),
  "$clusterTime" : {
    "clusterTime" : Timestamp(1586502478, 9),
    "signature" : {
      "hash" : BinData(0,"AAAAAAAAAAAAAAAAAAAAAAAAAAAAAAAA="),
      "keyId" : NumberLong(0)
    }
  }
}
mongos>
```

Chapter 16: Sharded Cluster Management and Development

```
File Edit View Search Terminal Help
balancer:
  Currently enabled: yes
  Currently running: no
  Failed balancer rounds in last 5 attempts: 0
  Migration Results for the last 24 hours:
    6 : Success
    83 : Failed with error 'aborted', from repl_shard_1 to repl_shard_2
databases:
```

```
File Edit View Search Terminal Help
2020-04-11T05:24:44.970+0000 W SHARDING [conn16] Chunk move failed :: caused by :: IndexNotFound
: can't find index with prefix { timezone: 1.0 } in storeCurrentLocs for biglittle.world_cities
2020-04-11T05:24:44.970+0000 I SHARDING [conn16] about to log metadata event into changelog: {
_id: "shard1:27018-2020-04-11T05:24:44.970+0000-5e91549c5167d4f87582aeeb", server: "shard1:27018",
shard: "repl_shard_1", clientAddr: "172.16.1.44:43752", time: new Date(1586582684970), what: "mo
veChunk.from", ns: "biglittle.world_cities", details: { min: { timezone: MinKey }, max: { timezon
e: "America/Anchorage" }, step 1 of 6: 0, step 2 of 6: 1, to: "repl_shard_2", from: "repl_shard_1
", note: "aborted" } }
```

```
File Edit View Search Terminal Help
mongos> db.world_cities.getShardDistribution();

Shard repl_shard_1 at repl_shard_1/shard1.biglittle.local:27018
data : 9.35MiB docs : 24217 chunks : 1
estimated data per chunk : 9.35MiB
estimated docs per chunk : 24217

Totals
data : 9.35MiB docs : 24217 chunks : 1
Shard repl_shard_1 contains 100% data, 100% docs in cluster, avg obj size on shard : 405B

mongos>
```

```
File Edit View Search Terminal Help
mongos> sh.addShardToZone("repl_shard_3", "pacific");
{
  "ok" : 1,
  "operationTime" : Timestamp(1586582099, 2),
  "$clusterTime" : {
    "clusterTime" : Timestamp(1586582099, 2),
    "signature" : {
      "hash" : BinData(0,"AAAAAAAAAAAAAAAAAAAAAAAAAAAA="),
      "keyId" : NumberLong(0)
    }
  }
}
mongos>
```

```
File Edit View Search Terminal Help
mongos> sh.updateZoneKeyRange(target, {"timezone":"Pacific/Apia"}, {"timezone":MaxKey}, "pacific");
{
  "ok" : 1,
  "operationTime" : Timestamp(1586582678, 1),
  "$clusterTime" : {
    "clusterTime" : Timestamp(1586582678, 1),
    "signature" : {
      "hash" : BinData(0,"AAAAAAAAAAAAAAAAAAAAAAAAAAAA="),
      "keyId" : NumberLong(0)
    }
  }
}
mongos>
```

```
File Edit View Search Terminal Help
mongos> sh.getBalancerState();
true
mongos> sh.stopBalancer();
{
  "ok" : 1,
  "operationTime" : Timestamp(1586839271, 2),
  "$clusterTime" : {
    "clusterTime" : Timestamp(1586839271, 2),
    "signature" : {
      "hash" : BinData(0,"AAAAAAAAAAAAAAAAAAAAAAAAAAAA="),
      "keyId" : NumberLong(0)
    }
  }
}
mongos> sh.getBalancerState();
false
mongos>
```

```
File Edit View Search Terminal Help
mongos> sh.startBalancer();
{
  "ok" : 1,
  "operationTime" : Timestamp(1586839855, 3),
  "$clusterTime" : {
    "clusterTime" : Timestamp(1586839855, 3),
    "signature" : {
      "hash" : BinData(0,"AAAAAAAAAAAAAAAAAAAAAAAAAAAA="),
      "keyId" : NumberLong(0)
    }
  }
}
mongos> sh.getBalancerState();
true
mongos>
```

```
File Edit View Search Terminal Help
mongos> db.world_cities.getShardDistribution();

Shard repl_shard_3 at repl_shard_3/shard3.biglittle.local:27018
data : 3.06MiB docs : 8054 chunks : 4
estimated data per chunk : 785KiB
estimated docs per chunk : 2013

Shard repl_shard_2 at repl_shard_2/shard2.biglittle.local:27018
data : 3.62MiB docs : 9400 chunks : 2
estimated data per chunk : 1.81MiB
estimated docs per chunk : 4700

Shard repl_shard_1 at repl_shard_1/shard1.biglittle.local:27018
data : 2.65MiB docs : 6763 chunks : 2
estimated data per chunk : 1.32MiB
estimated docs per chunk : 3381

Totals
data : 9.35MiB docs : 24217 chunks : 8
Shard repl_shard_3 contains 32.8% data, 33.25% docs in cluster, avg obj size on shard : 399B
Shard repl_shard_2 contains 38.79% data, 38.81% docs in cluster, avg obj size on shard : 404B
Shard repl_shard_1 contains 28.4% data, 27.92% docs in cluster, avg obj size on shard : 411B

mongos>
```

```
File Edit View Search Terminal Help
mongos> db.world_cities.aggregate(doc);
{ "_id" : "Europe/A", "total" : 342 }
{ "_id" : "Europe/B", "total" : 1619 }
{ "_id" : "Europe/C", "total" : 70 }
{ "_id" : "Europe/D", "total" : 32 }
{ "_id" : "Europe/G", "total" : 2 }
{ "_id" : "Europe/H", "total" : 74 }
{ "_id" : "Europe/I", "total" : 393 }
{ "_id" : "Europe/J", "total" : 1 }
{ "_id" : "Europe/K", "total" : 219 }
{ "_id" : "Europe/L", "total" : 910 }
{ "_id" : "Europe/M", "total" : 1316 }
{ "_id" : "Europe/O", "total" : 33 }
{ "_id" : "Europe/P", "total" : 746 }
{ "_id" : "Europe/R", "total" : 592 }
{ "_id" : "Europe/S", "total" : 273 }
{ "_id" : "Europe/T", "total" : 31 }
{ "_id" : "Europe/U", "total" : 11 }
{ "_id" : "Europe/V", "total" : 103 }
{ "_id" : "Europe/W", "total" : 333 }
{ "_id" : "Europe/Z", "total" : 142 }
mongos>
```

```
File Edit View Search Terminal Help
mongos> sh.splitAt("biglittle.world_cities", split_query);
{
  "ok" : 1,
  "operationTime" : Timestamp(1586763567, 1),
  "$clusterTime" : {
    "clusterTime" : Timestamp(1586763576, 4),
    "signature" : {
      "hash" : BinData(0,"AAAAAAAAAAAAAAAAAAAAAAAAAAAA="),
      "keyId" : NumberLong(0)
    }
  }
}
mongos>
```

```
File Edit View Search Terminal Help
jed@jed:~/Repos/learn-mongodb/chapters/14$ python test_shard_one_server.py
      Timezone | Count
      - - - - - | - - - - -
America/Anchorage |      4
Europe/Amsterdam |      0
Asia/Aden |      0
jed@jed:~/Repos/learn-mongodb/chapters/14$
```

```
File Edit View Search Terminal Help
jed@jed:~/Repos/learn-mongodb/chapters/14$ python test_shard_mongos.py
      Timezone | Count
      - - - - - | - - - - -
America/Anchorage |      4
Europe/Amsterdam |     224
Asia/Aden |      23
jed@jed:~/Repos/learn-mongodb/chapters/14$
```

