

Chapter 1: Introducing Advanced Deep Learning with Keras

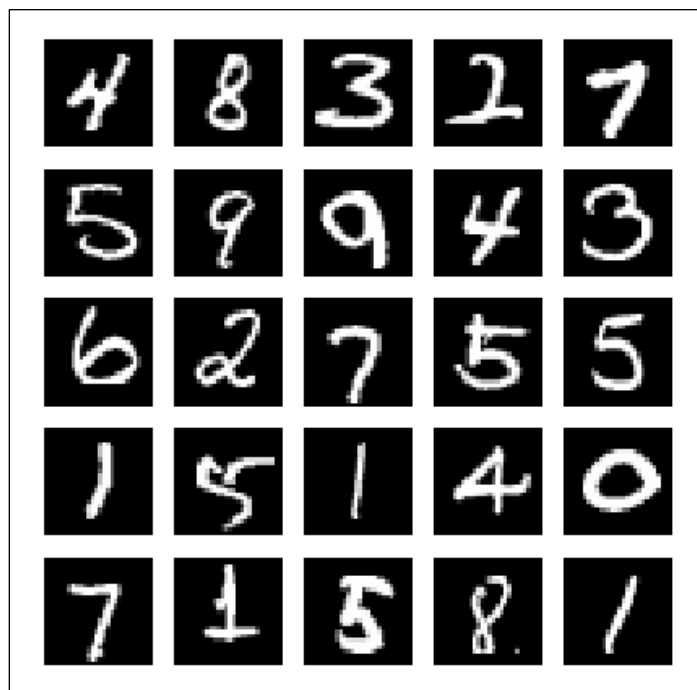

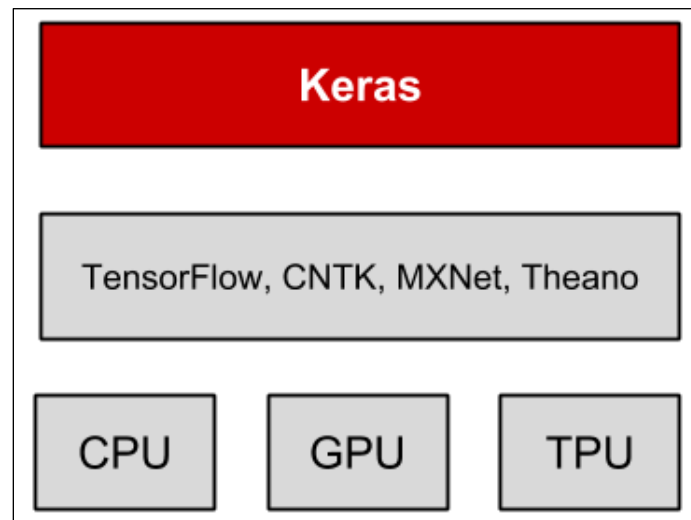

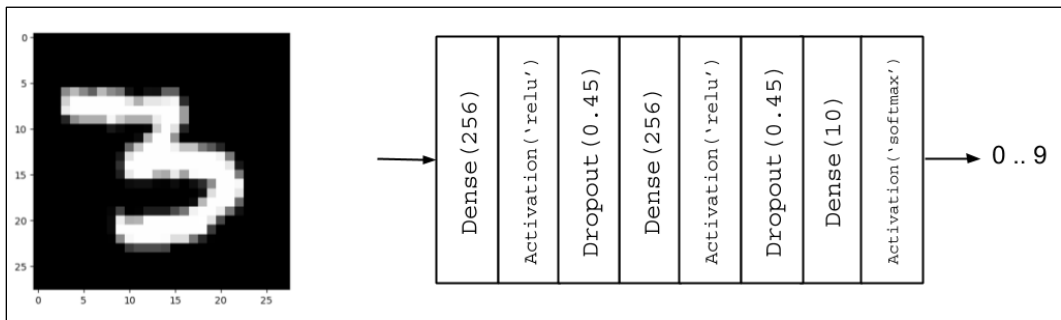

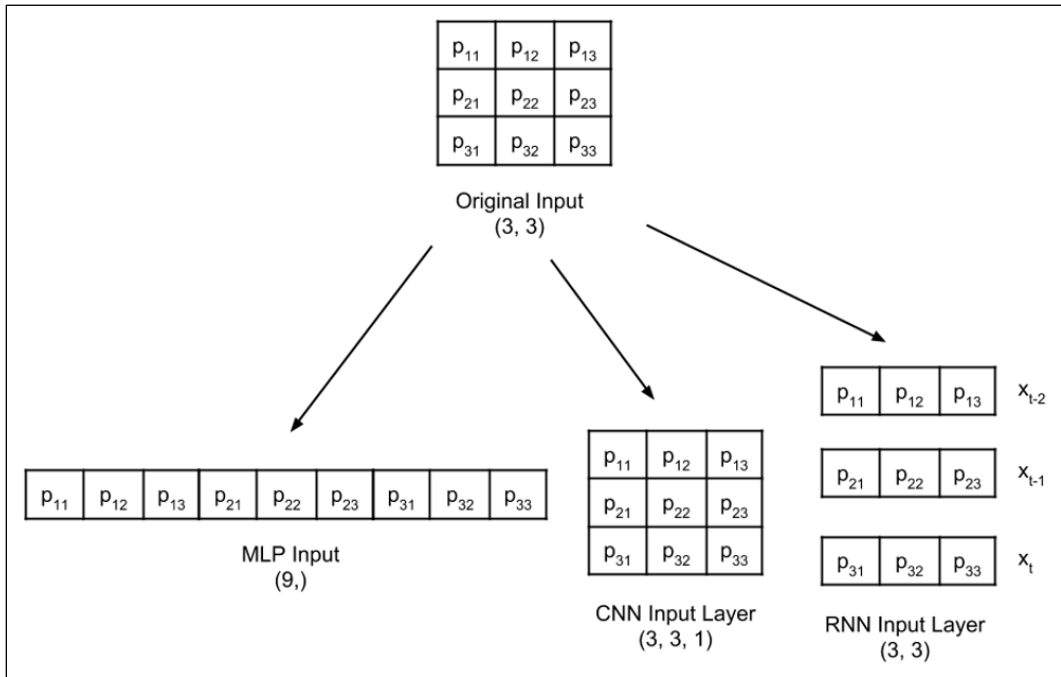
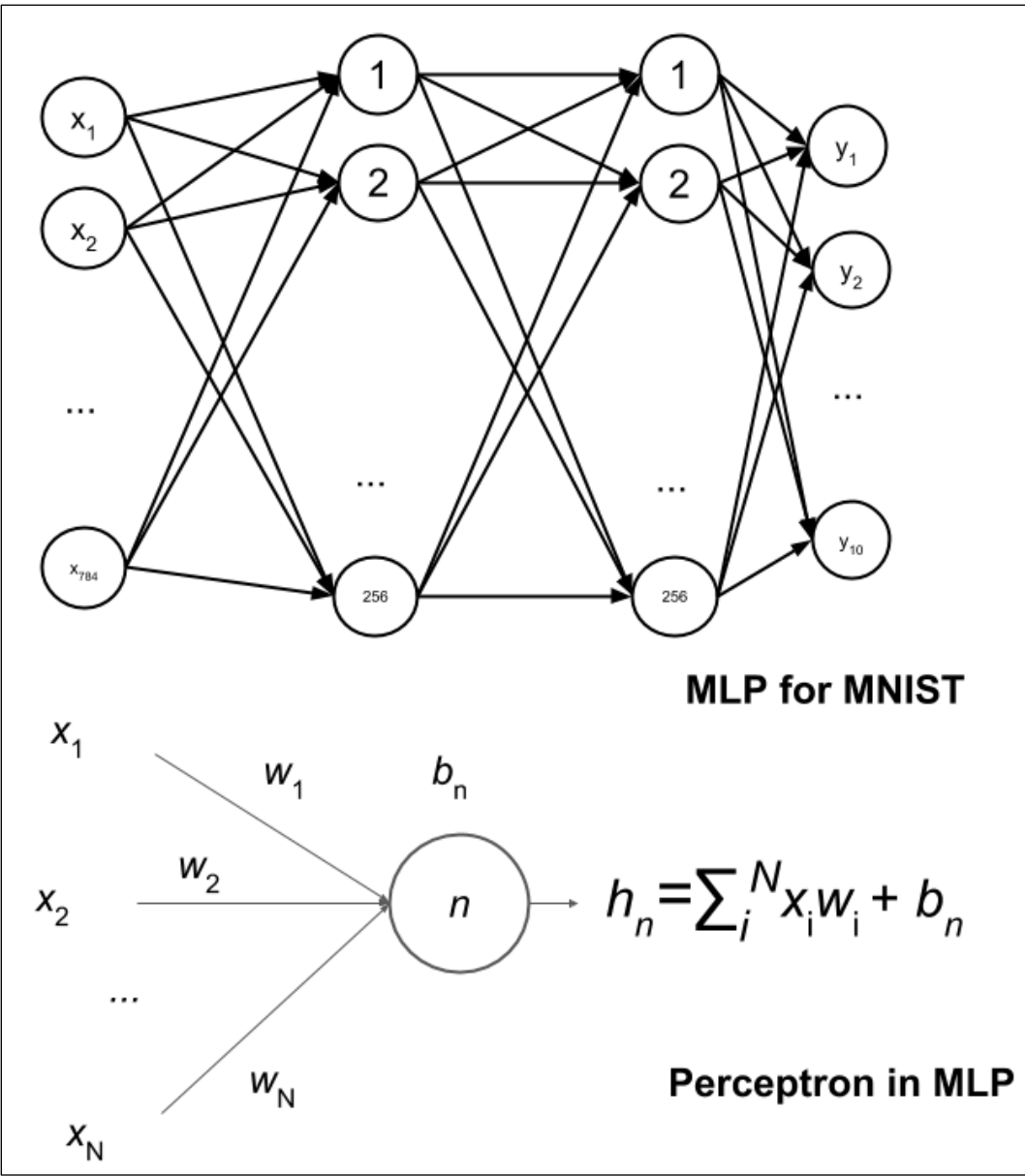
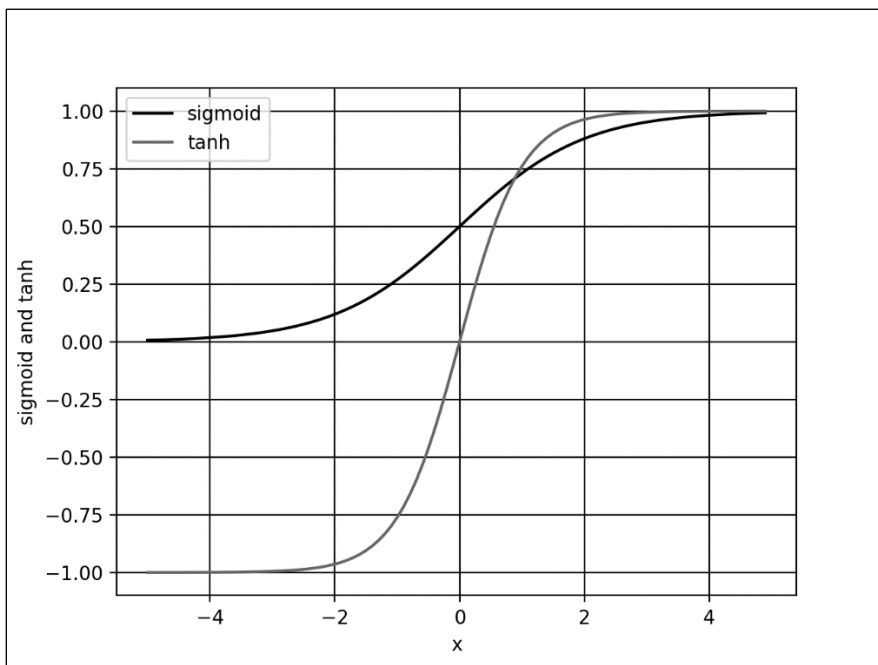
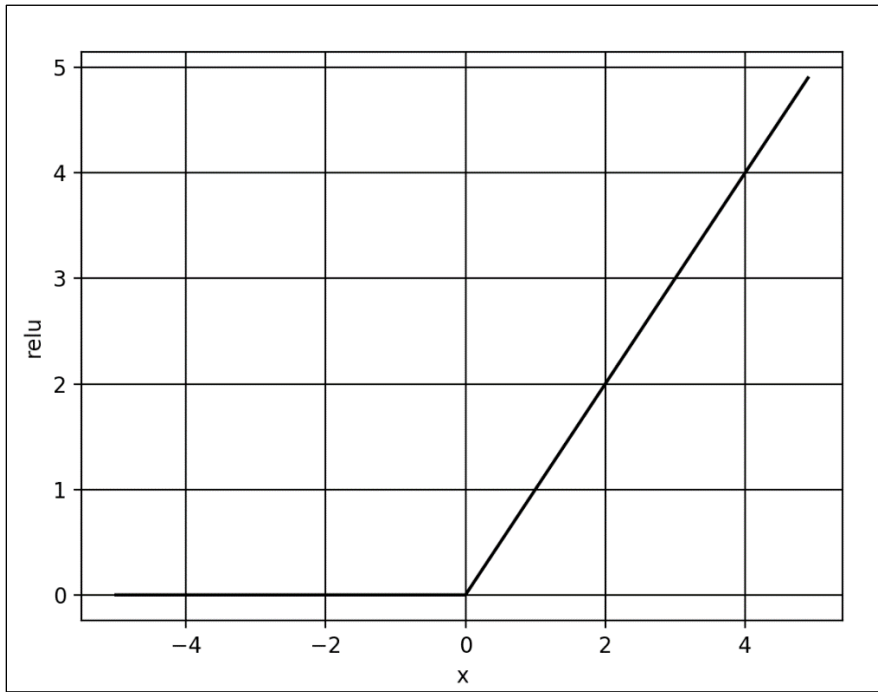

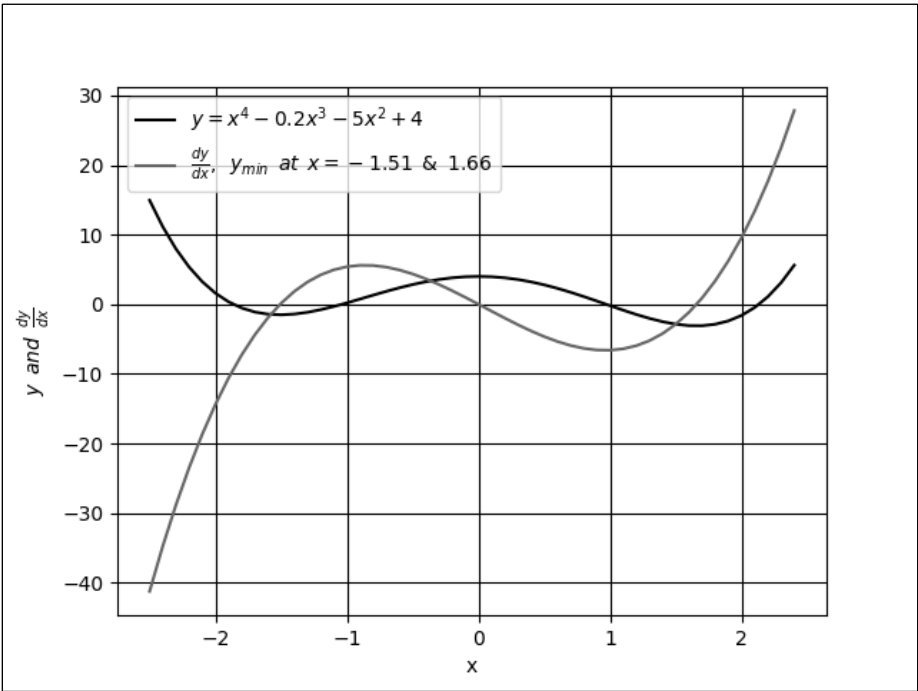
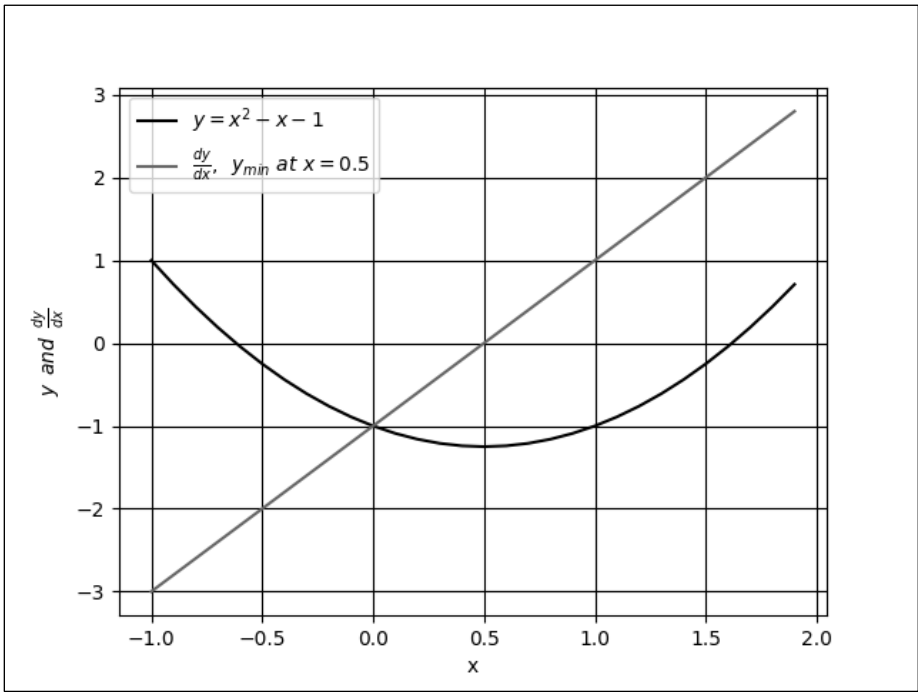

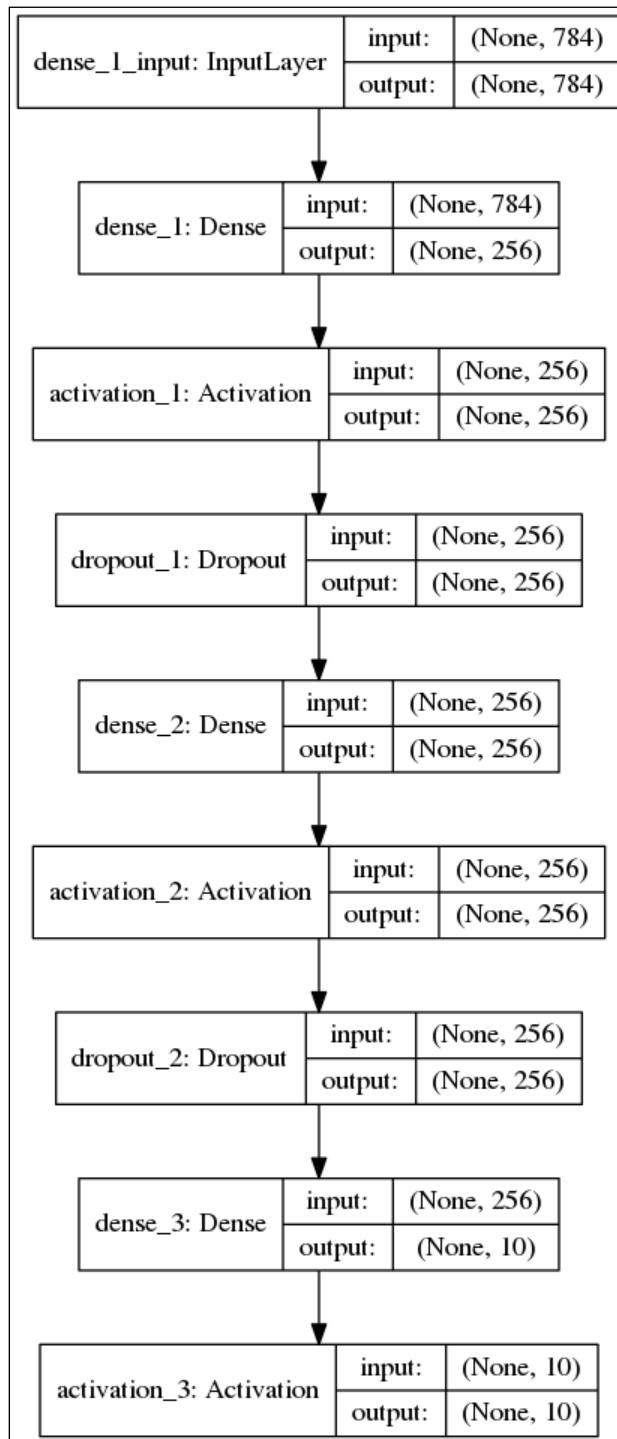

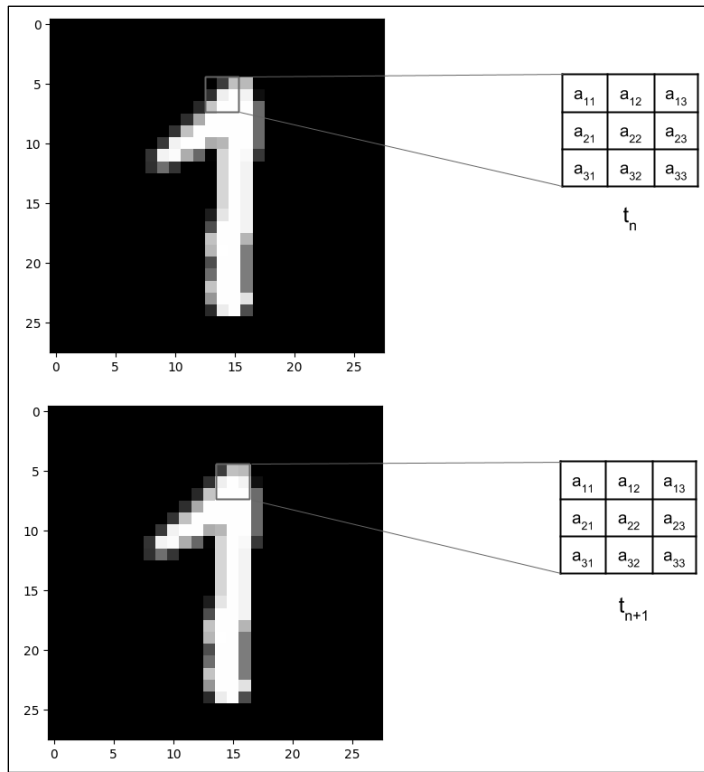
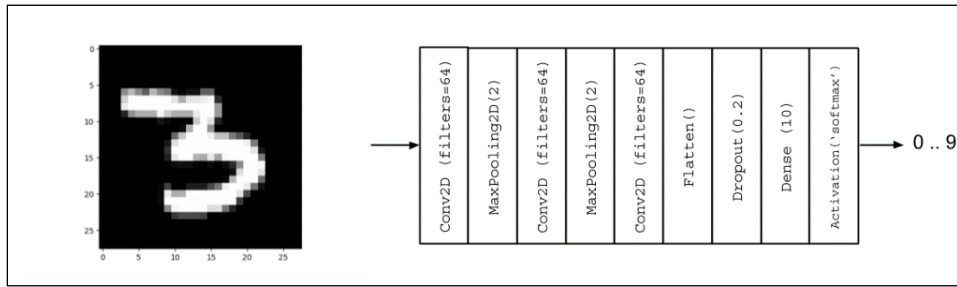

$$\begin{bmatrix} p_{11} & p_{12} & p_{13} & p_{14} & p_{15} \\ p_{21} & p_{22} & p_{23} & p_{24} & p_{25} \\ p_{31} & p_{32} & p_{33} & p_{34} & p_{35} \\ p_{41} & p_{42} & p_{43} & p_{44} & p_{45} \\ p_{51} & p_{52} & p_{53} & p_{54} & p_{55} \end{bmatrix} \otimes \begin{bmatrix} a_{11} & a_{12} & a_{13} \\ a_{21} & a_{22} & a_{23} \\ a_{31} & a_{32} & a_{33} \end{bmatrix} = \begin{bmatrix} f_{11} & f_{12} & f_{13} \\ f_{21} & f_{22} & f_{23} \\ f_{31} & f_{32} & f_{33} \end{bmatrix}$$

$$f_{11} = p_{11}a_{11} + p_{12}a_{12} + p_{13}a_{13} + p_{21}a_{21} + p_{22}a_{22} + p_{23}a_{23} + p_{31}a_{31} + p_{32}a_{32} + p_{33}a_{33}$$

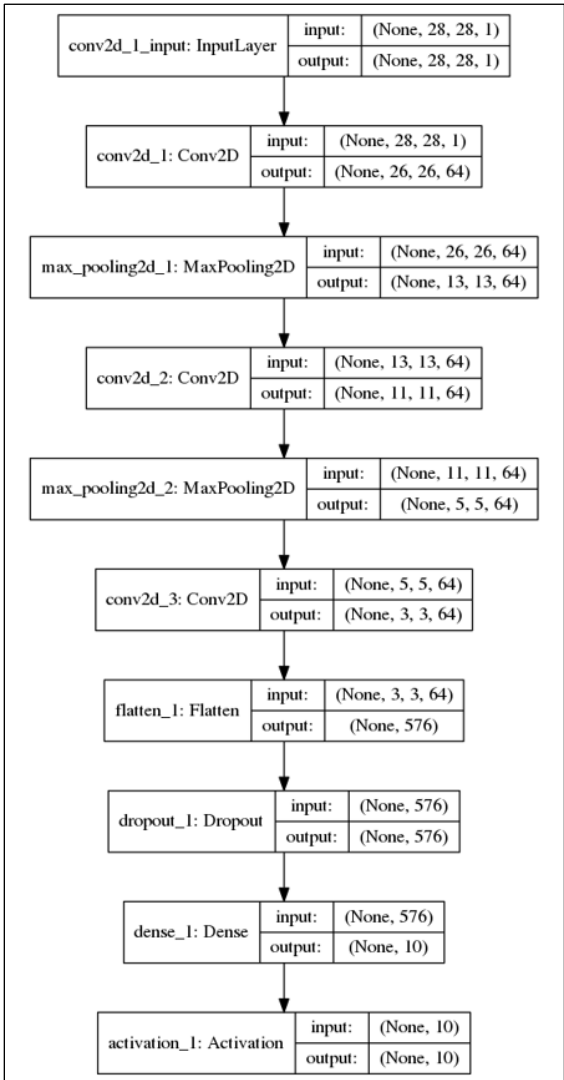
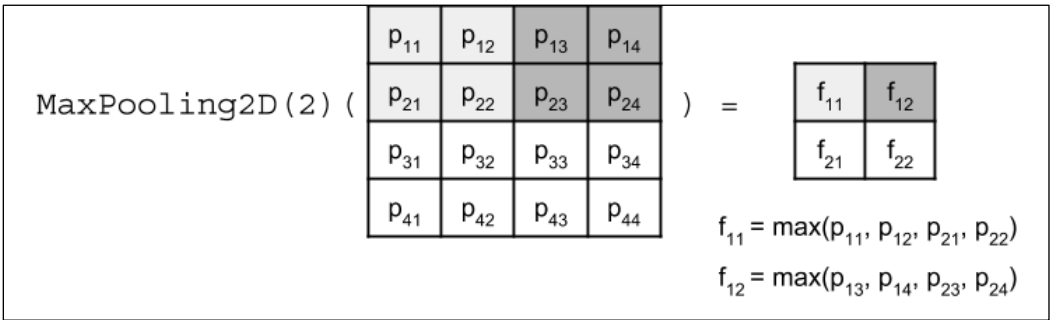

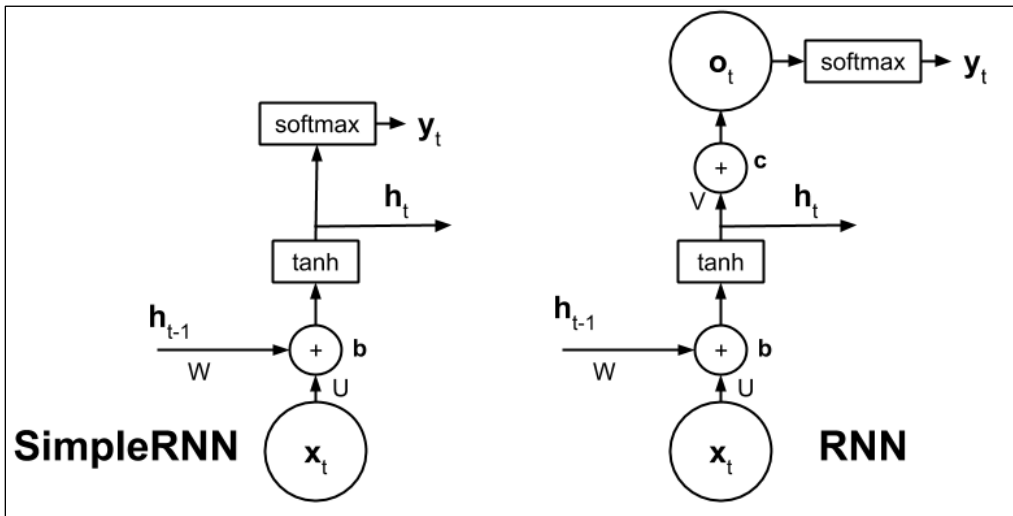
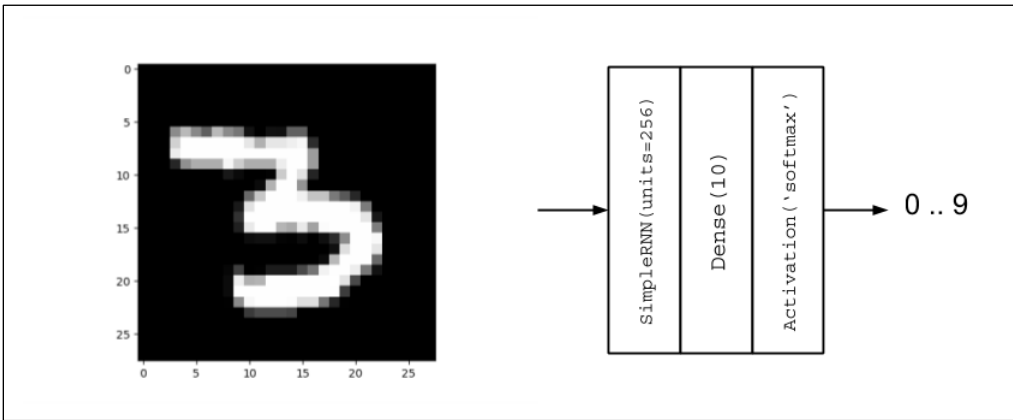

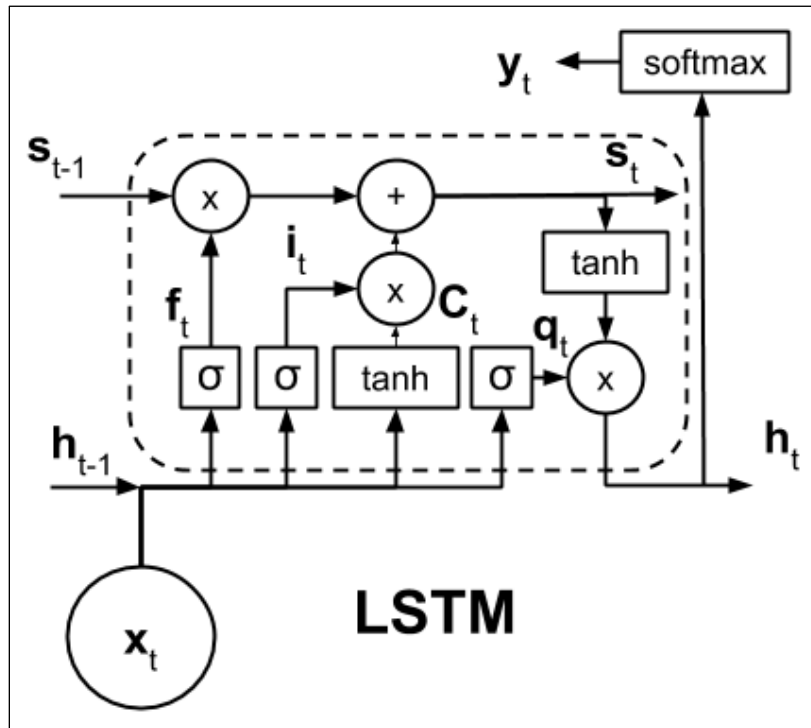
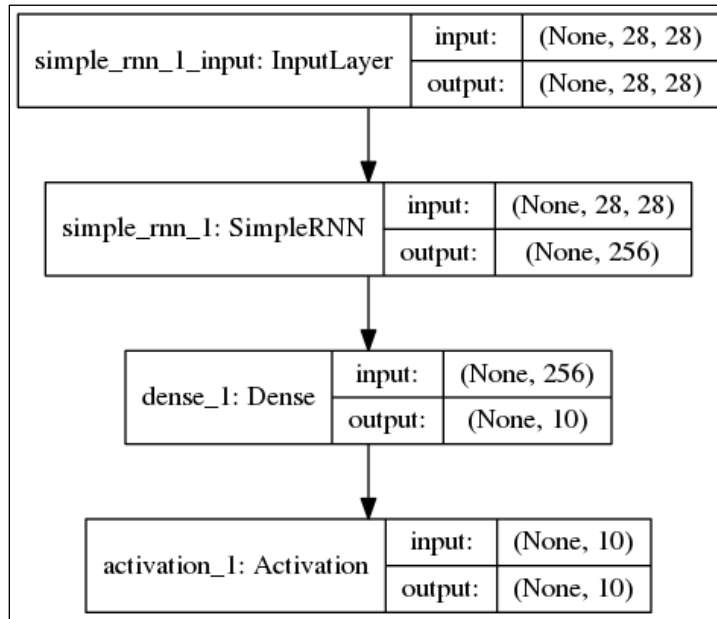

Chapter 2: Deep Neural Networks

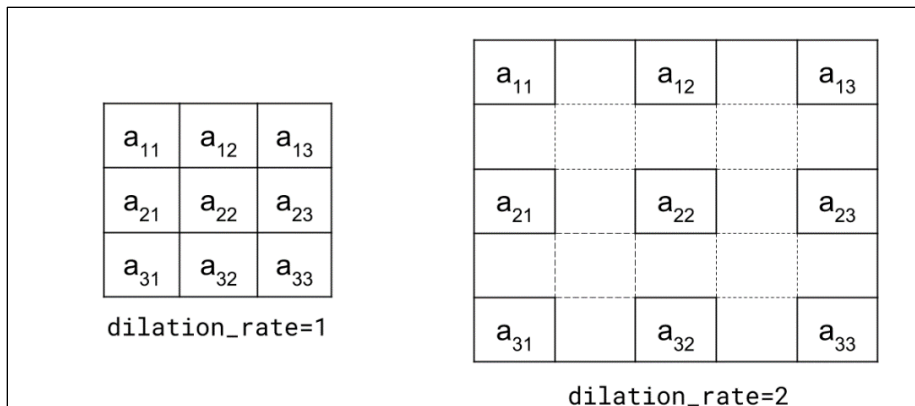
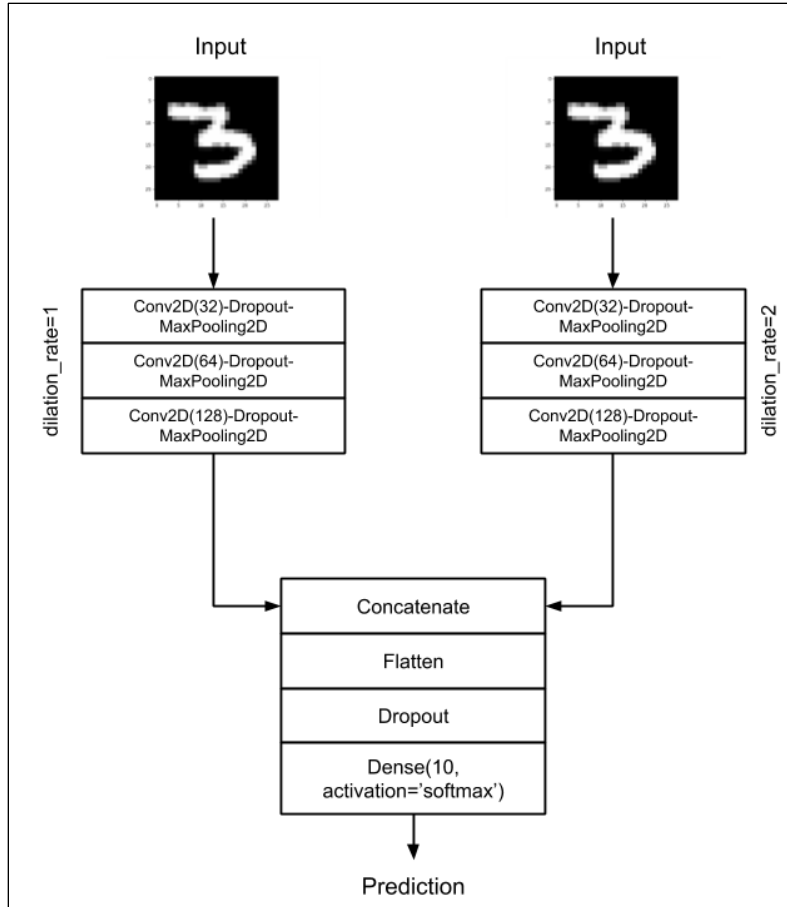

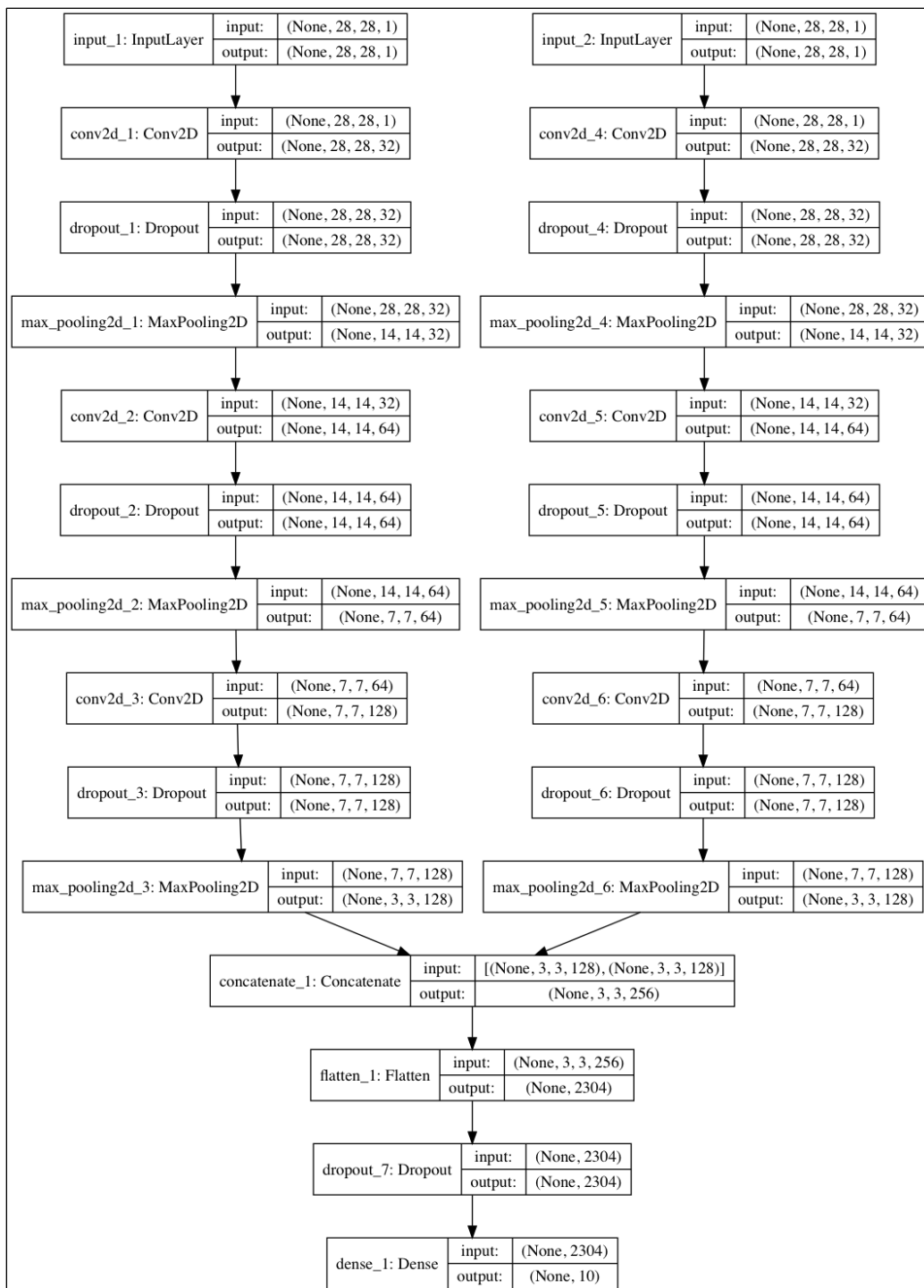

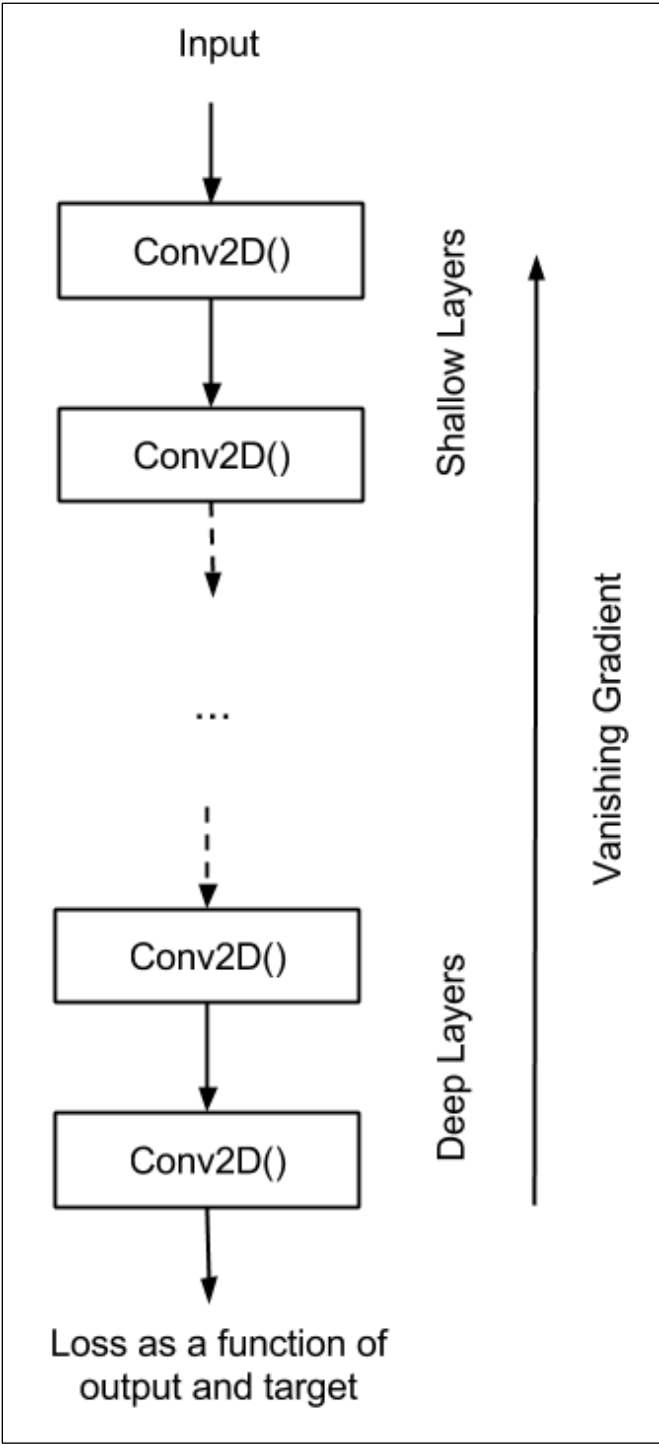

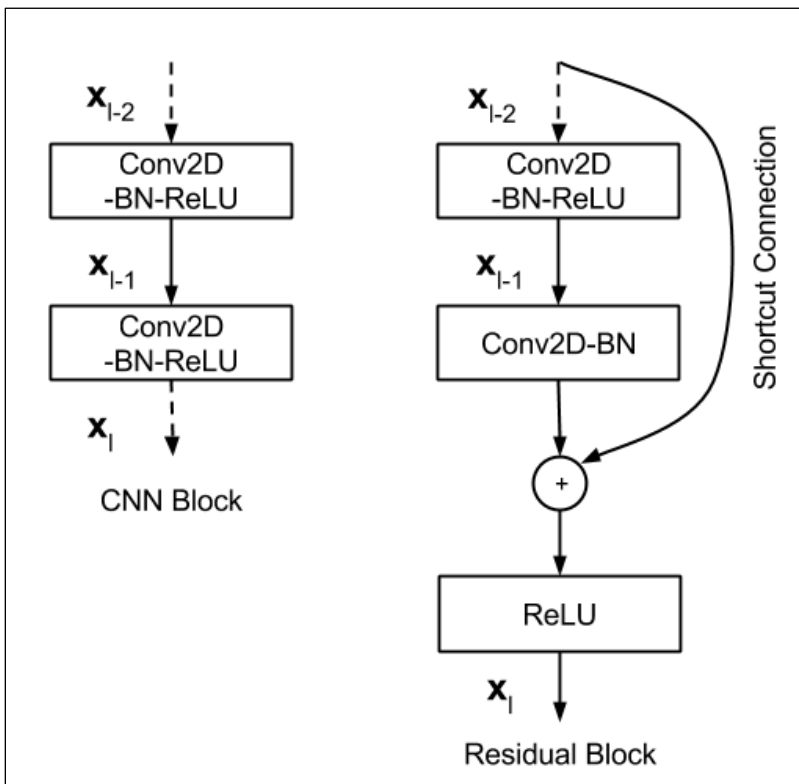
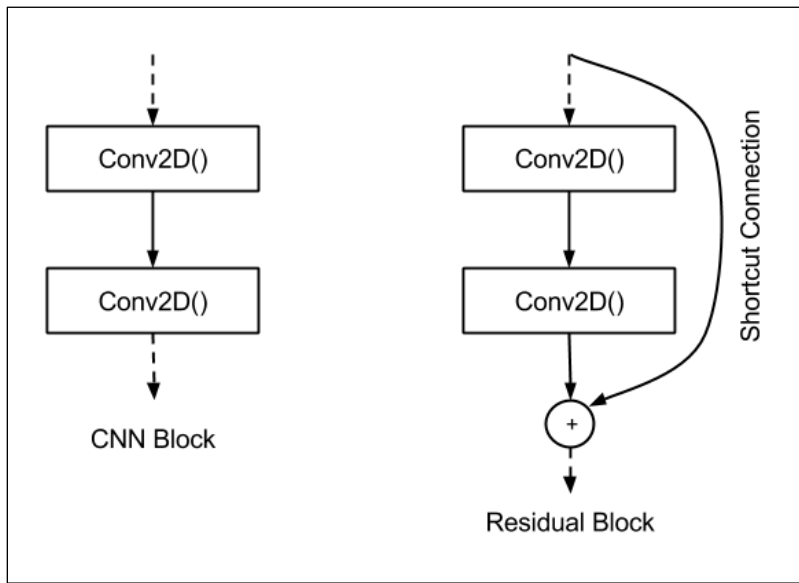



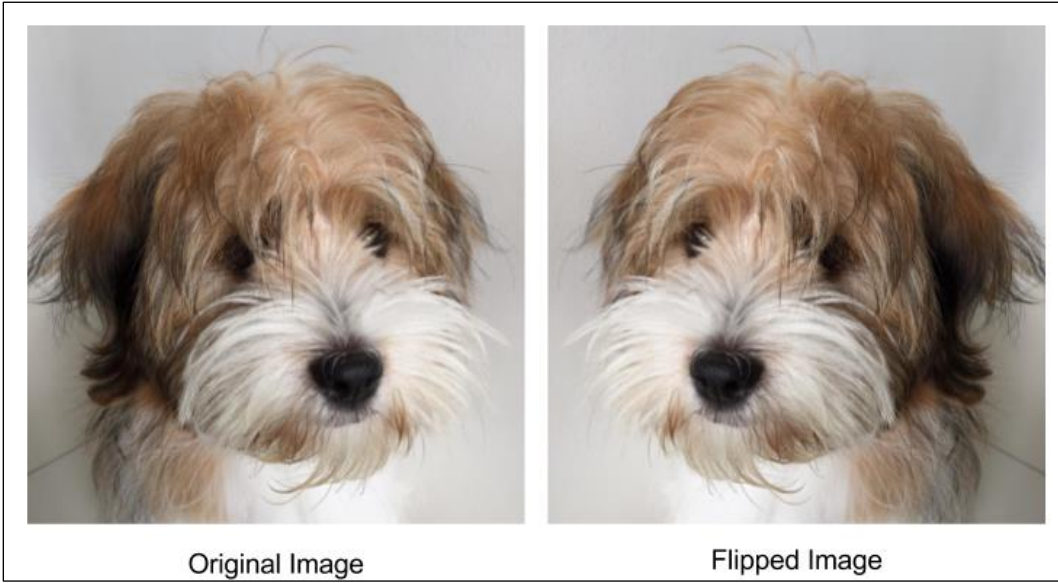
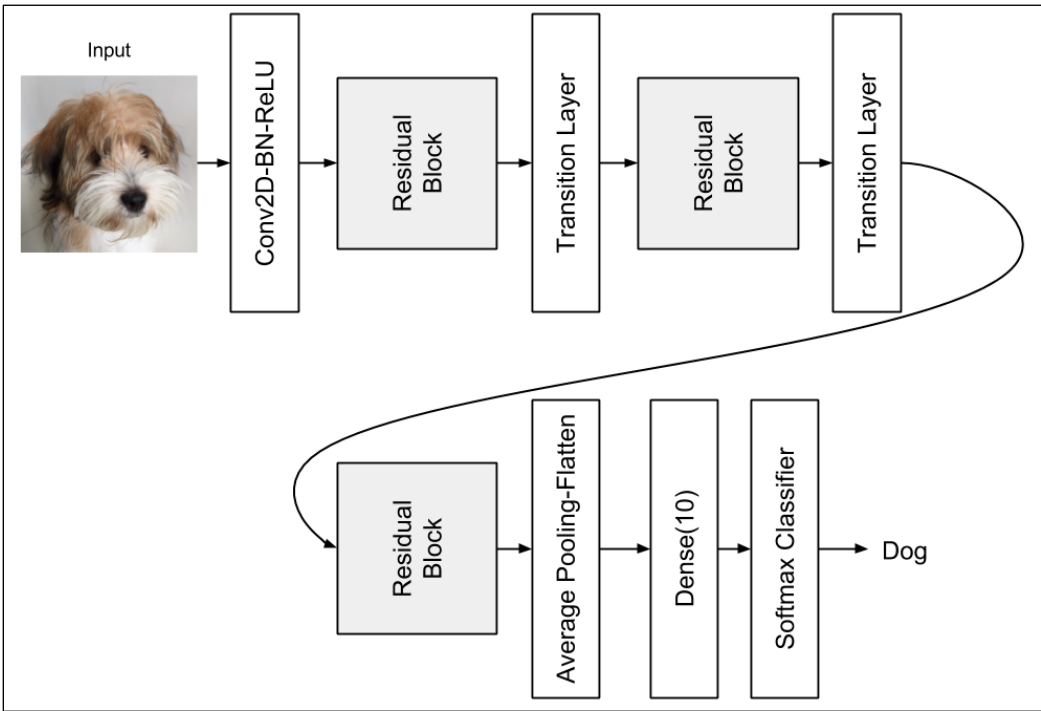

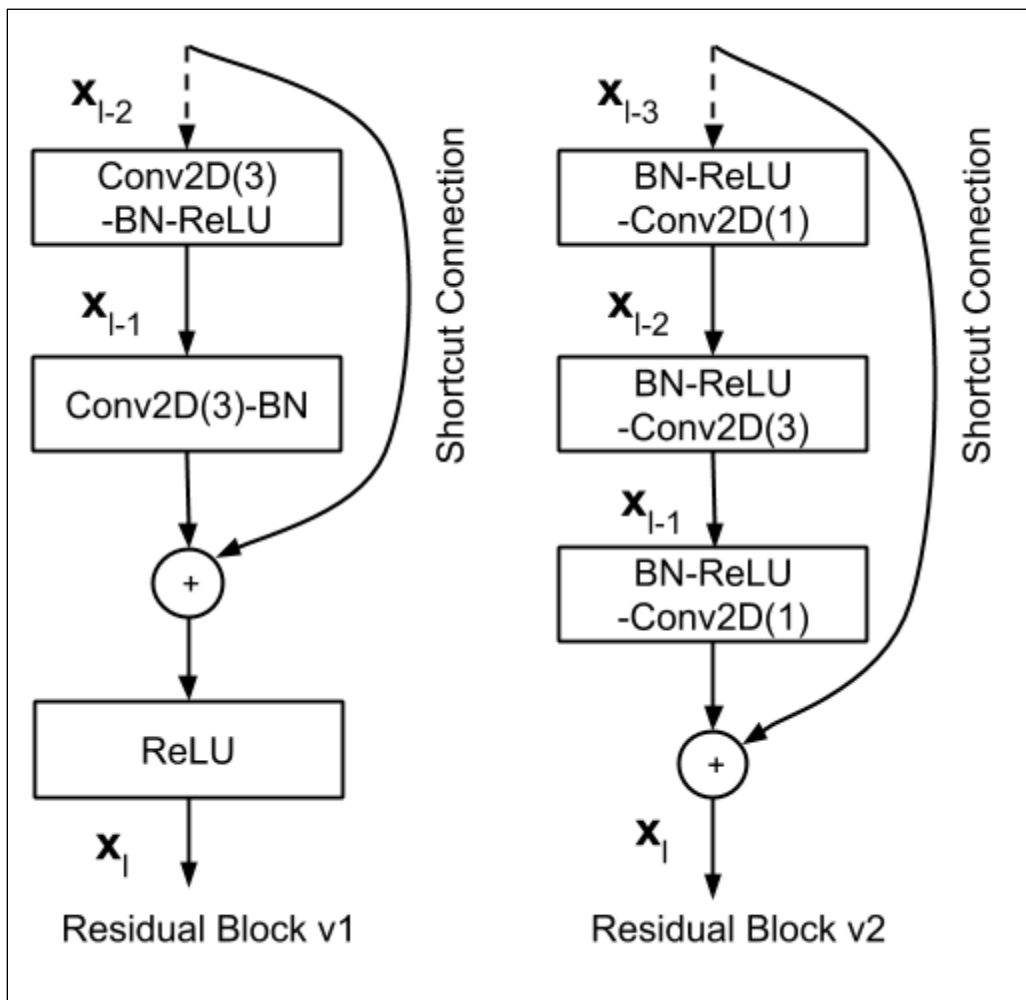

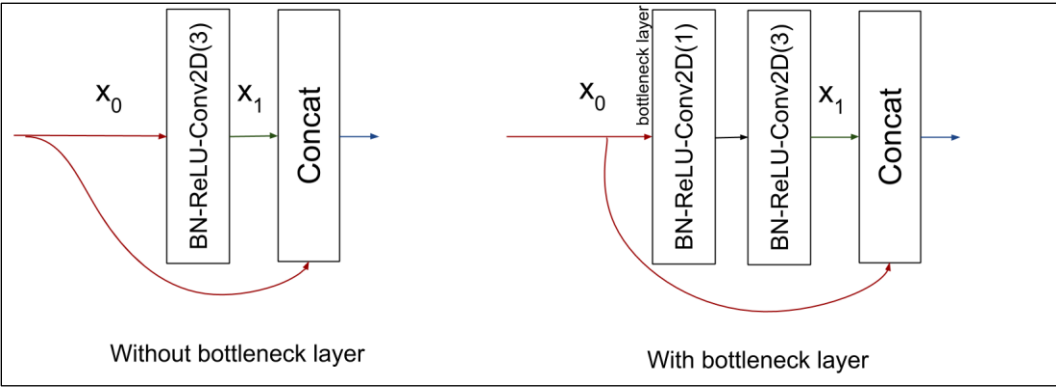
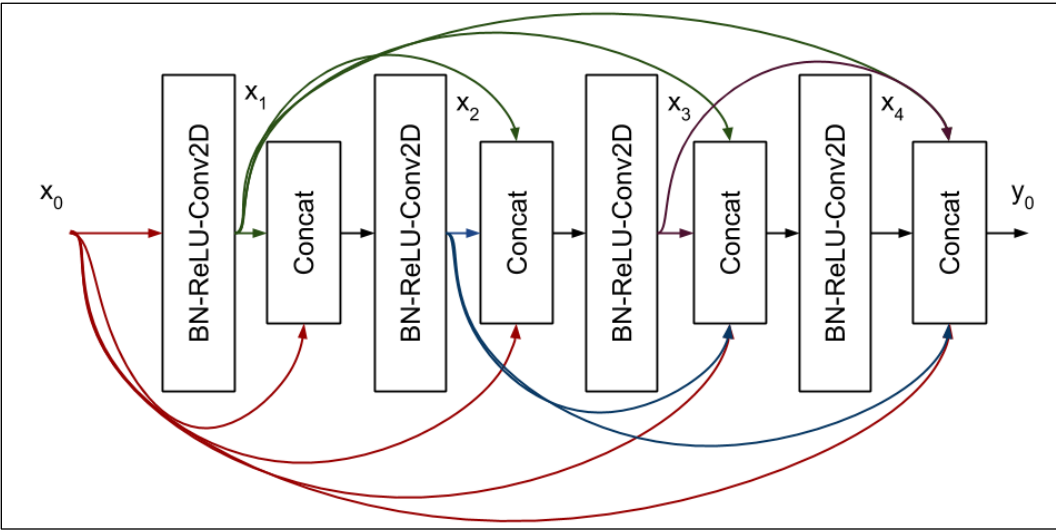

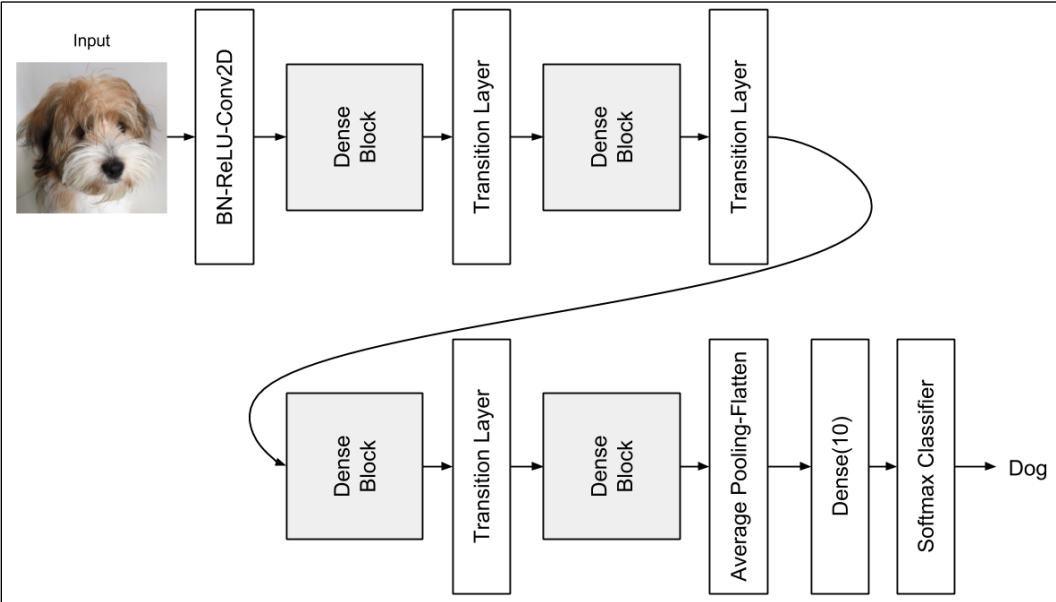
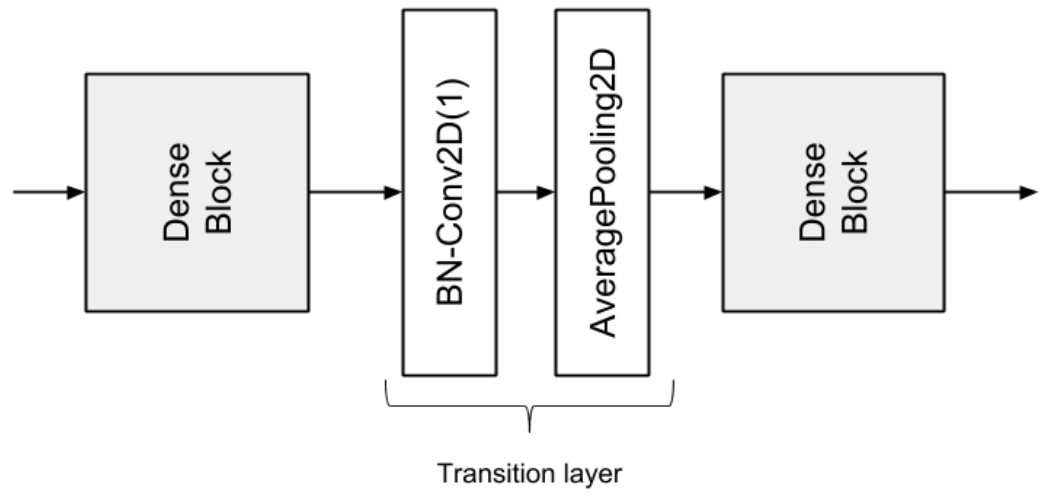

Chapter 3: Autoencoders

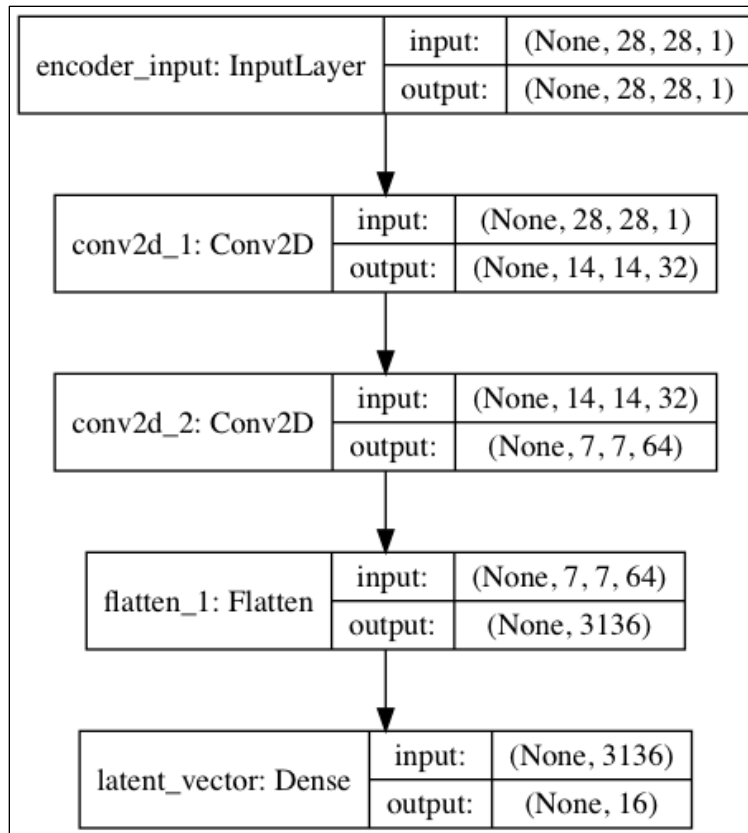
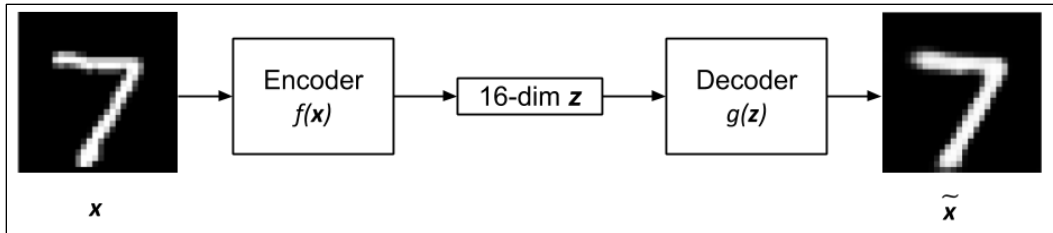
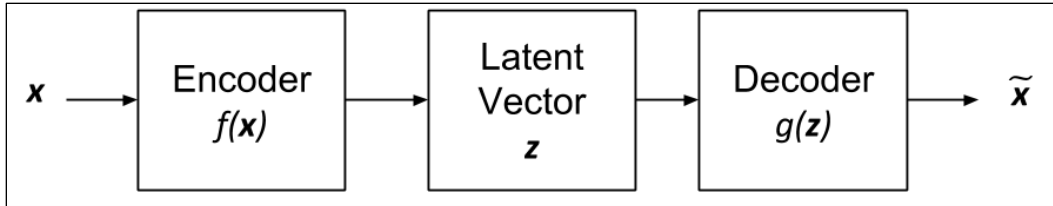

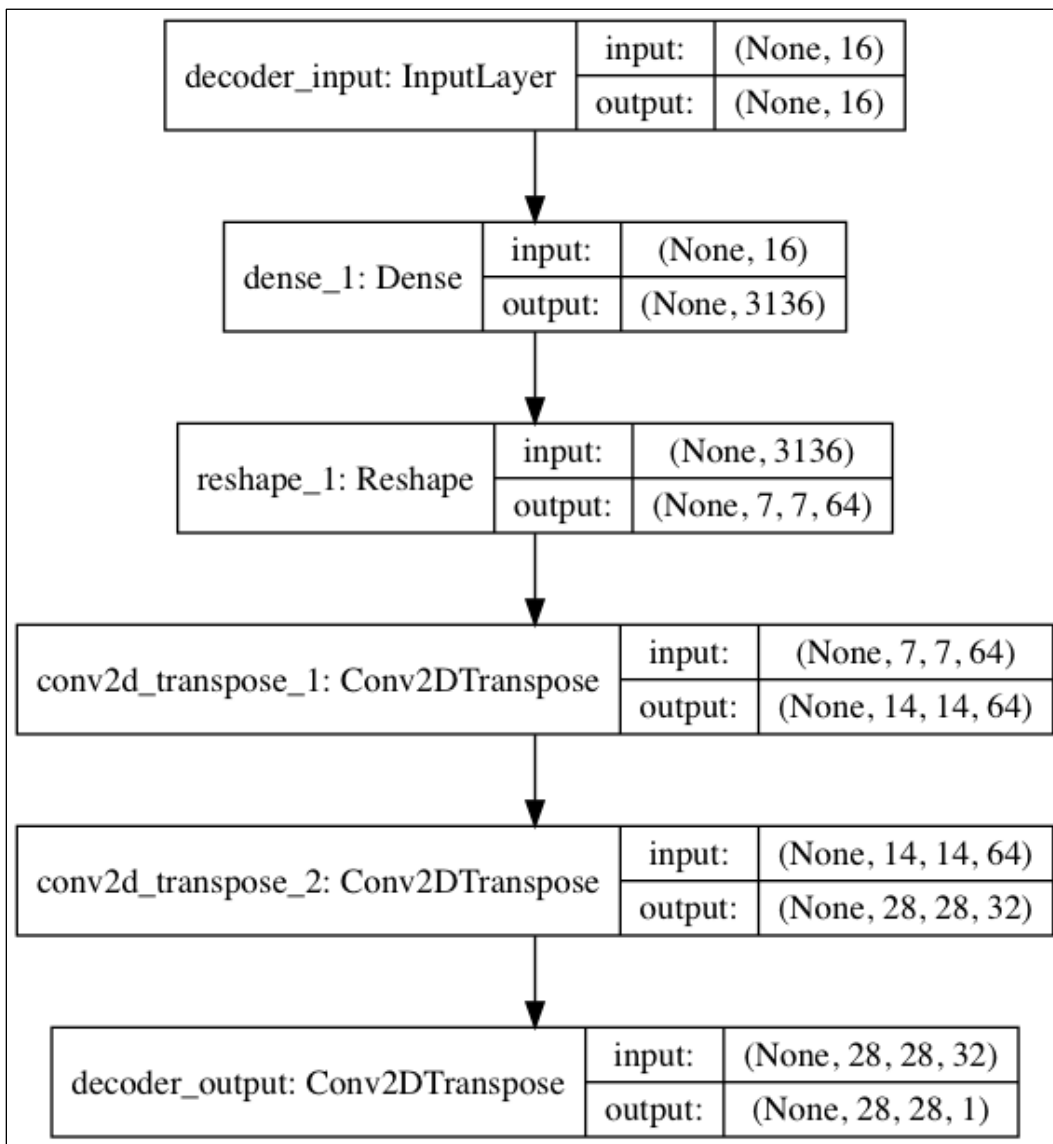

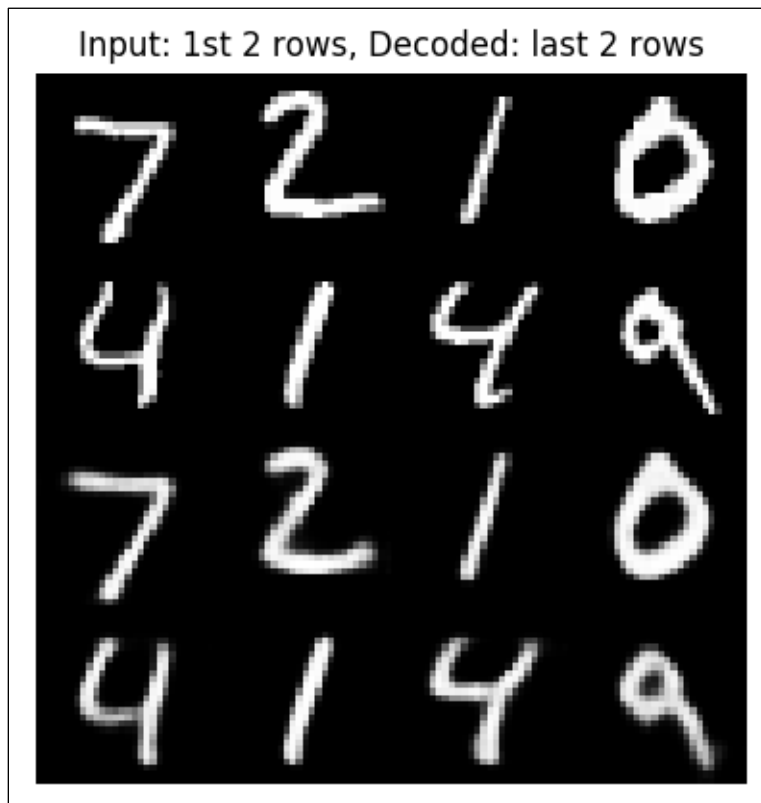
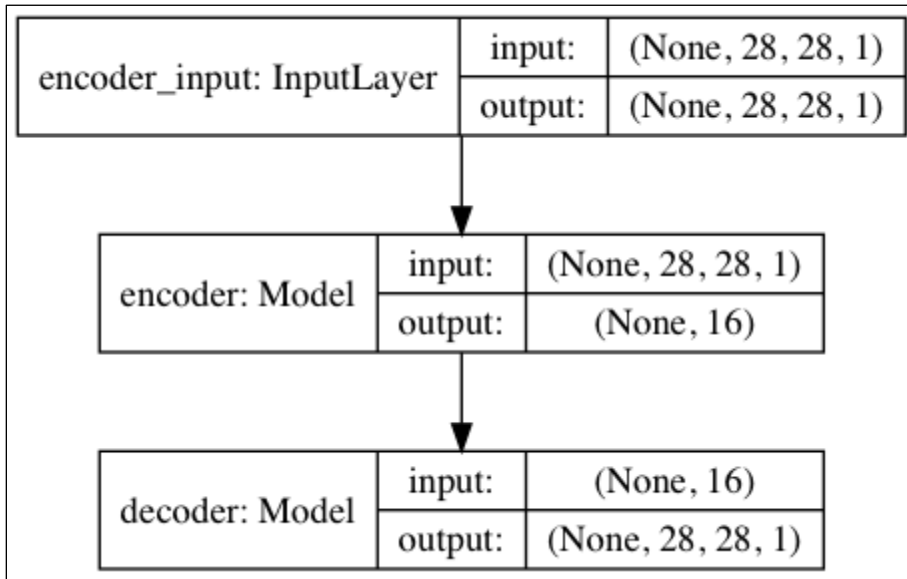

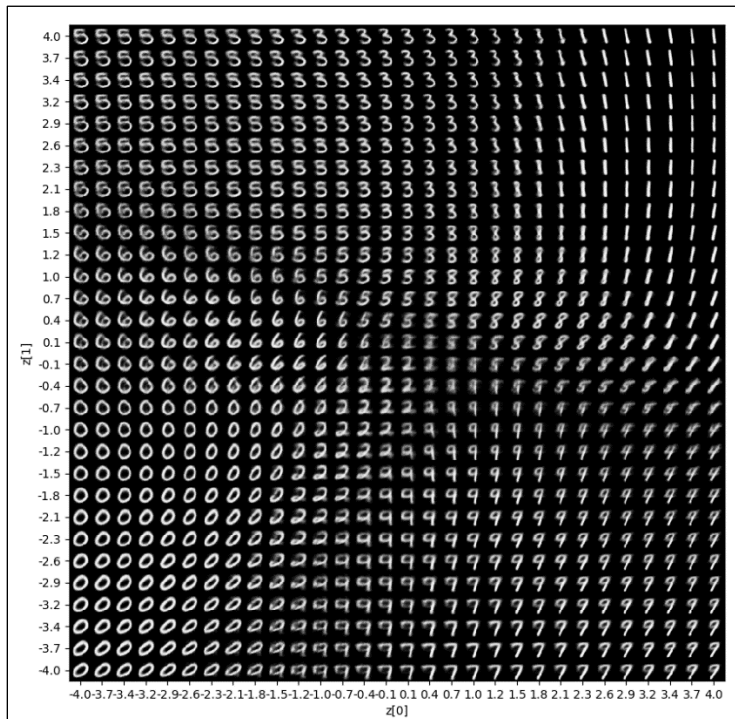
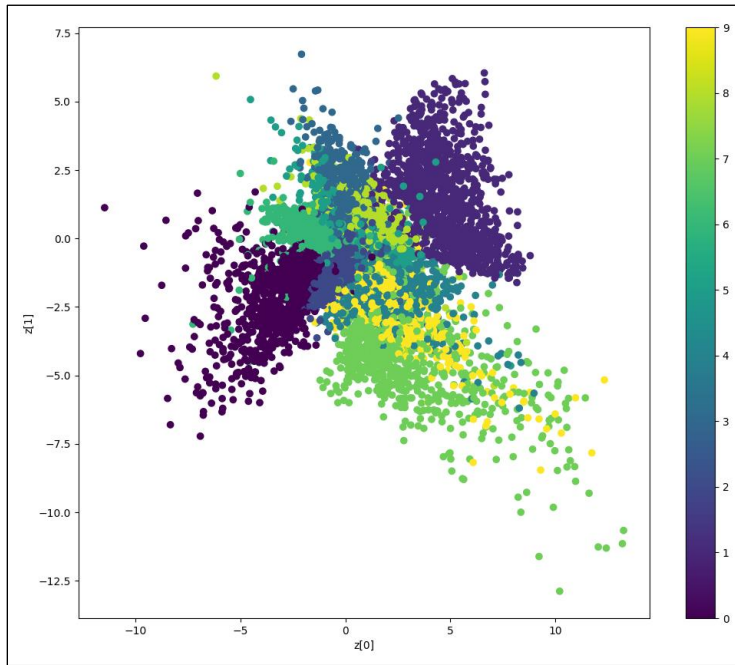

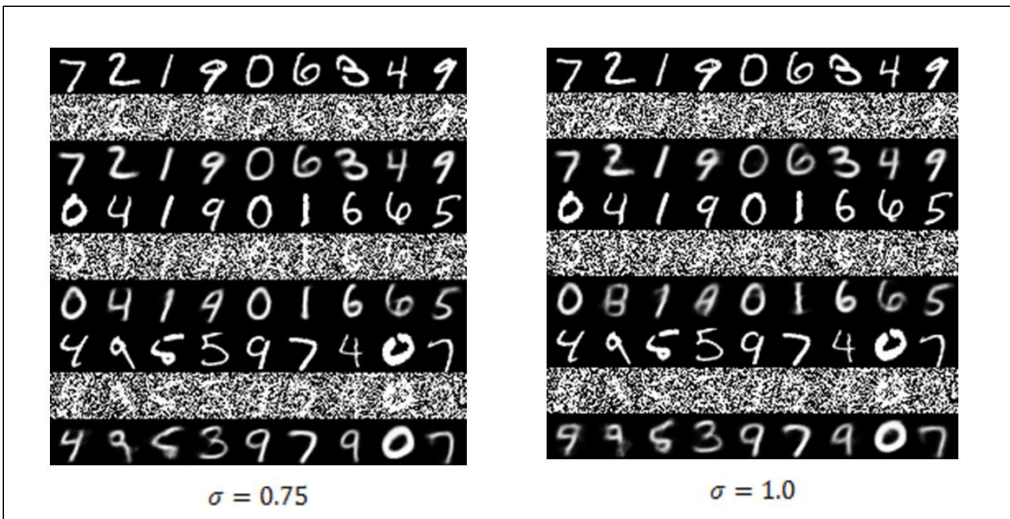
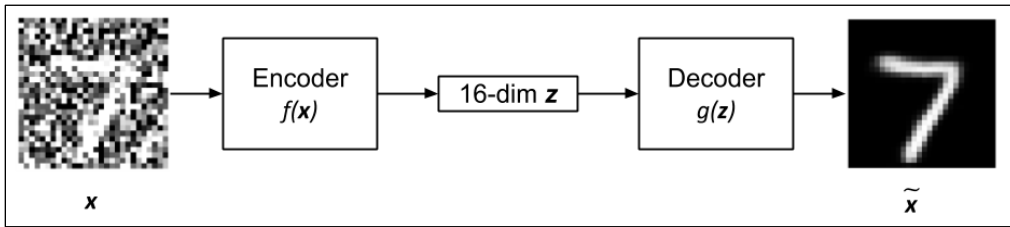
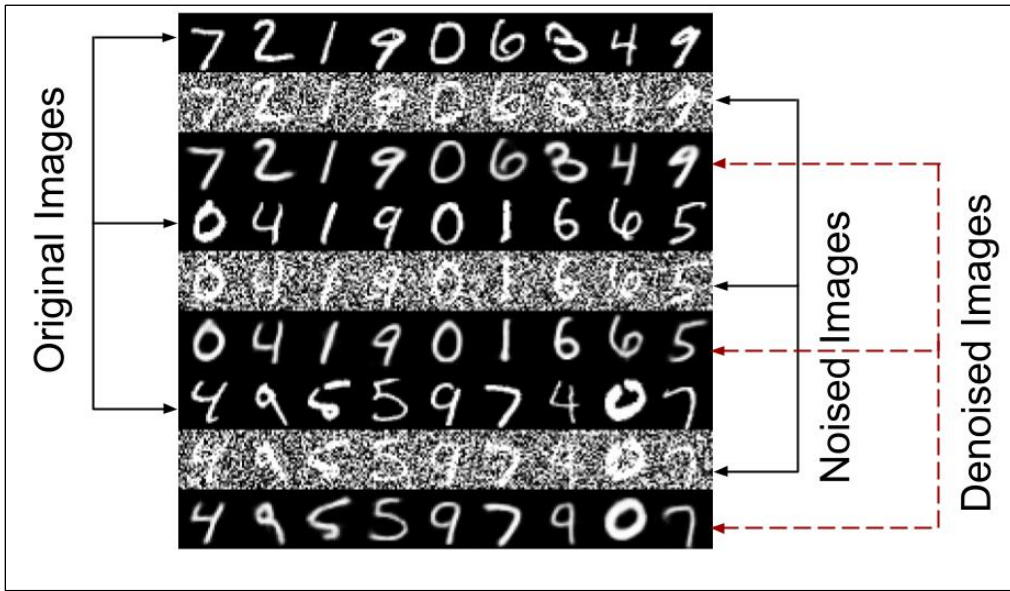

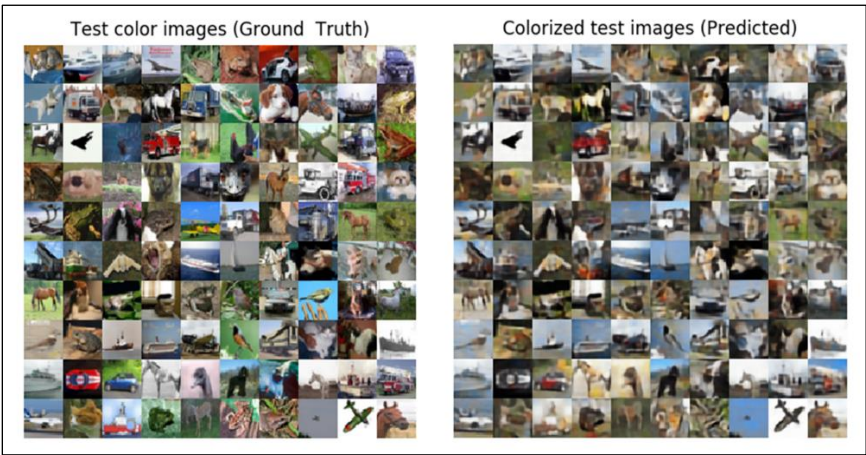
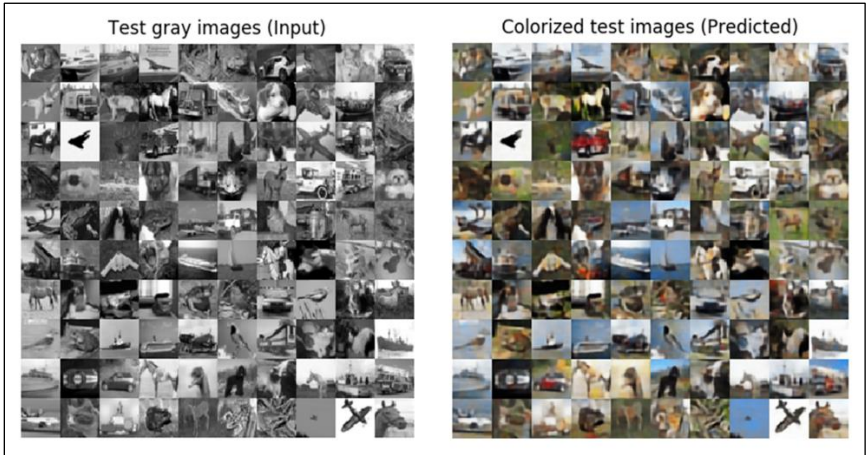

Chapter 4: Generative Adversarial Networks (GANs)

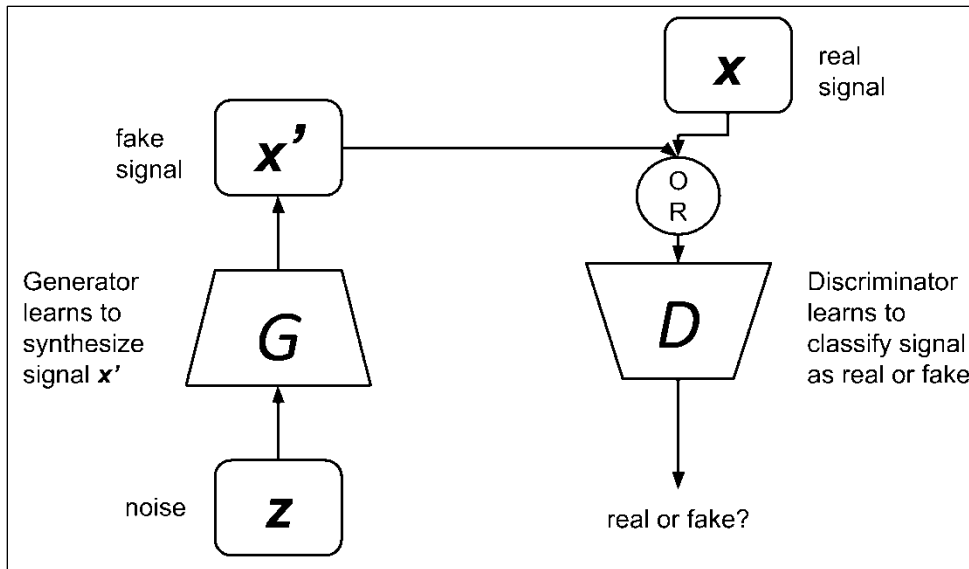
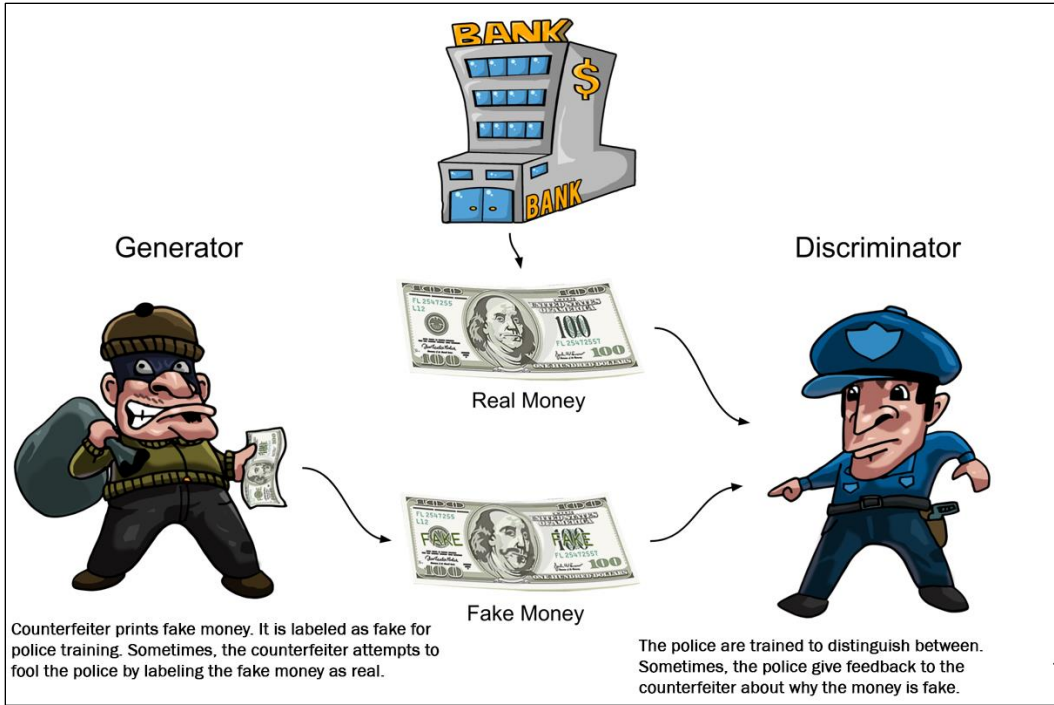

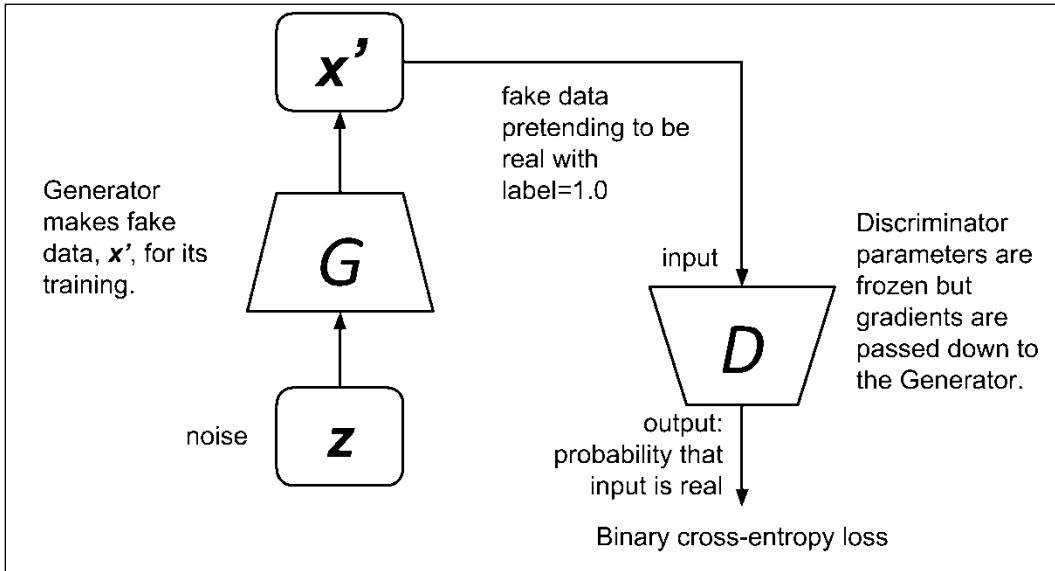
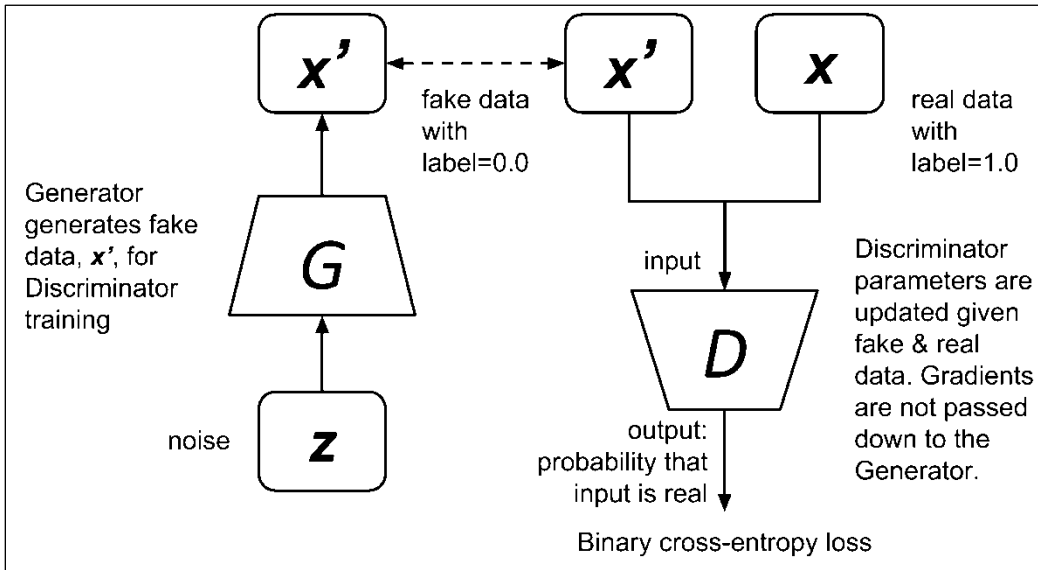

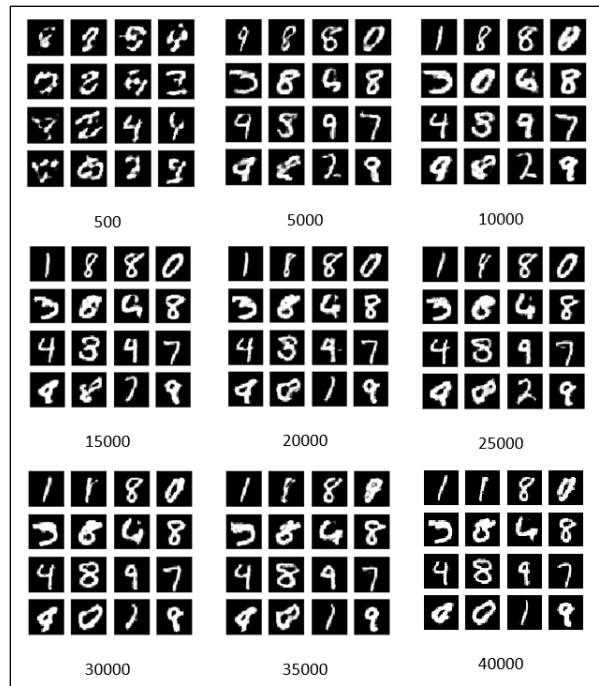
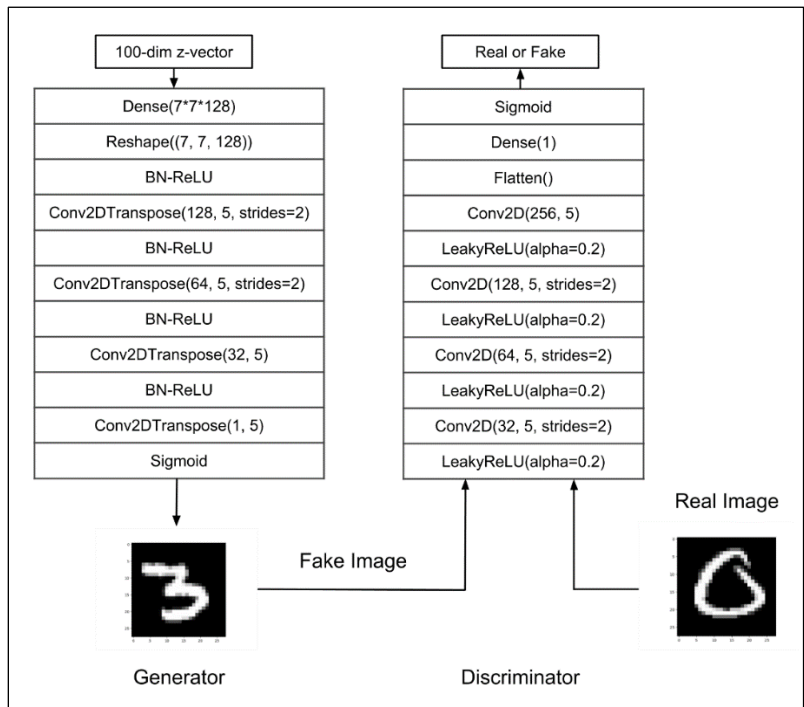

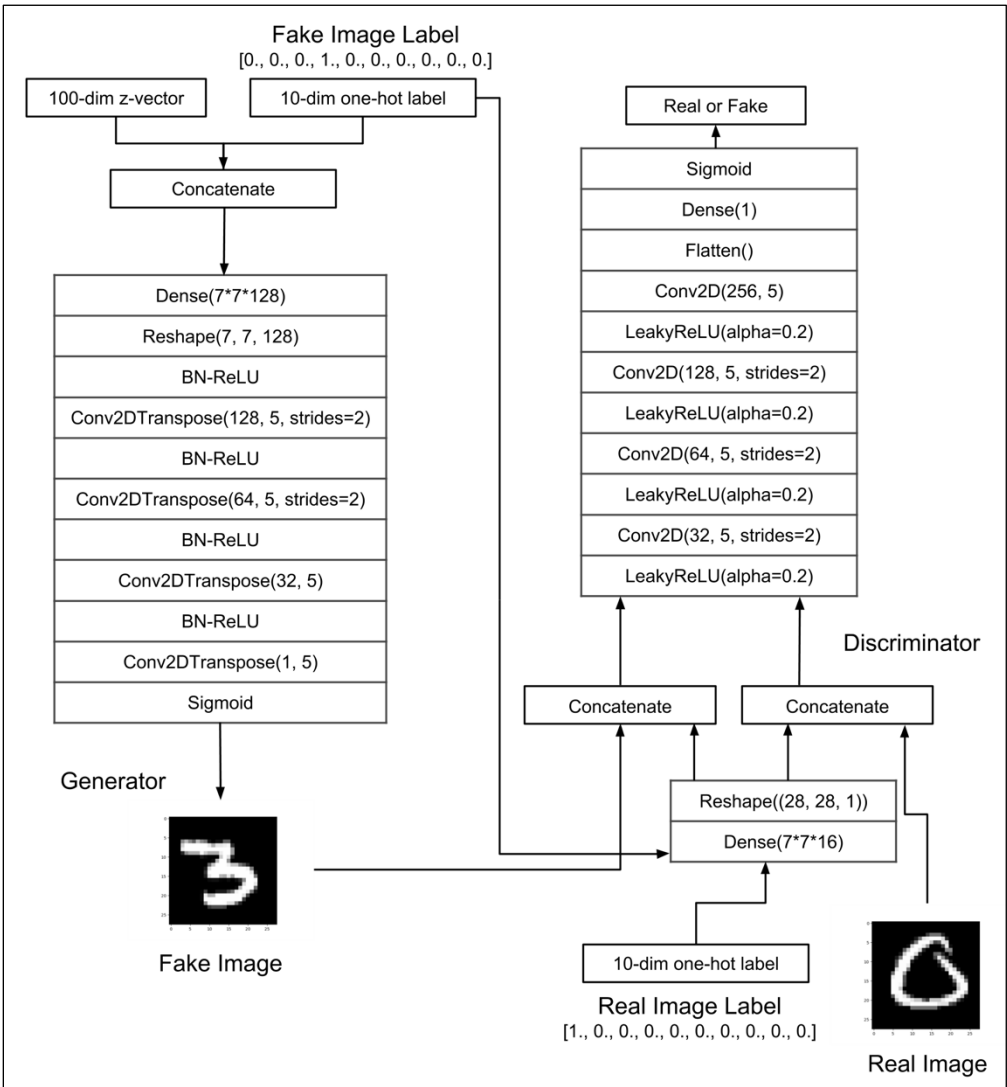

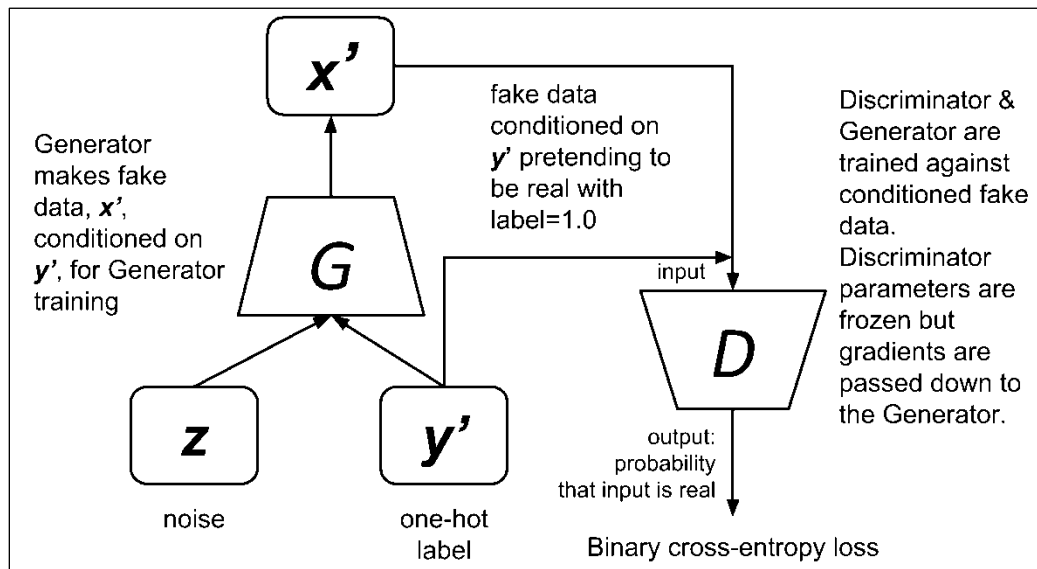
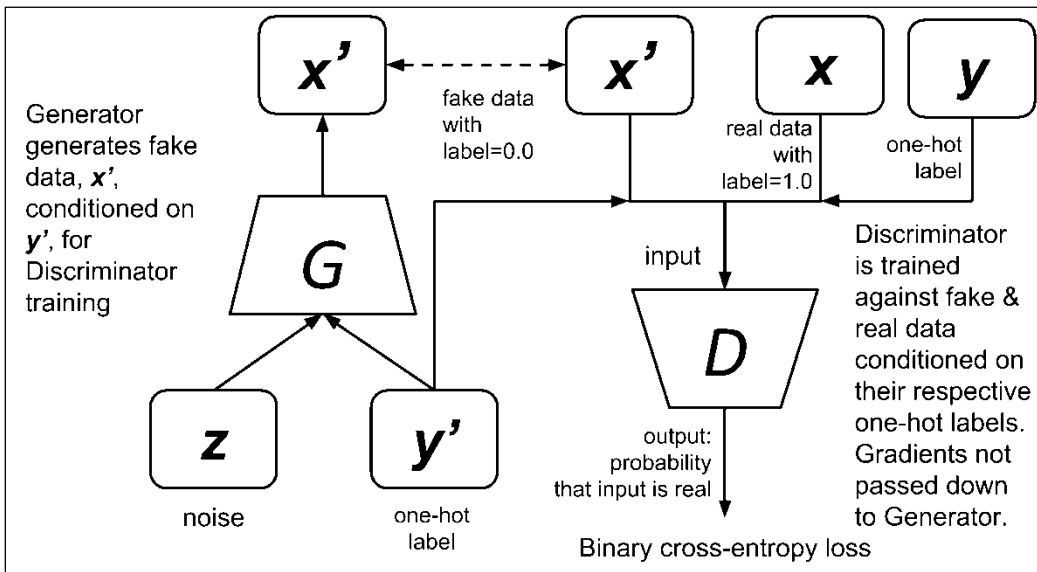



500

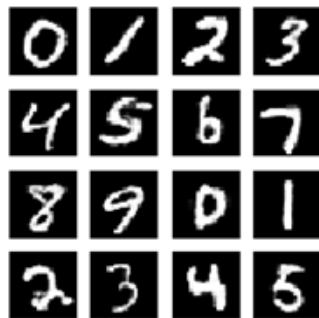

5000

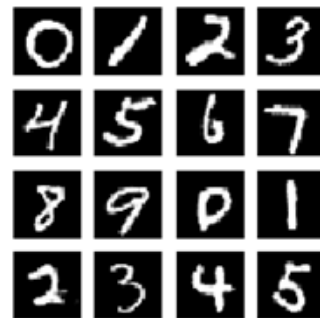

10000



15000



20000



25000



30000



35000



40000

Chapter 5: Improved GANs

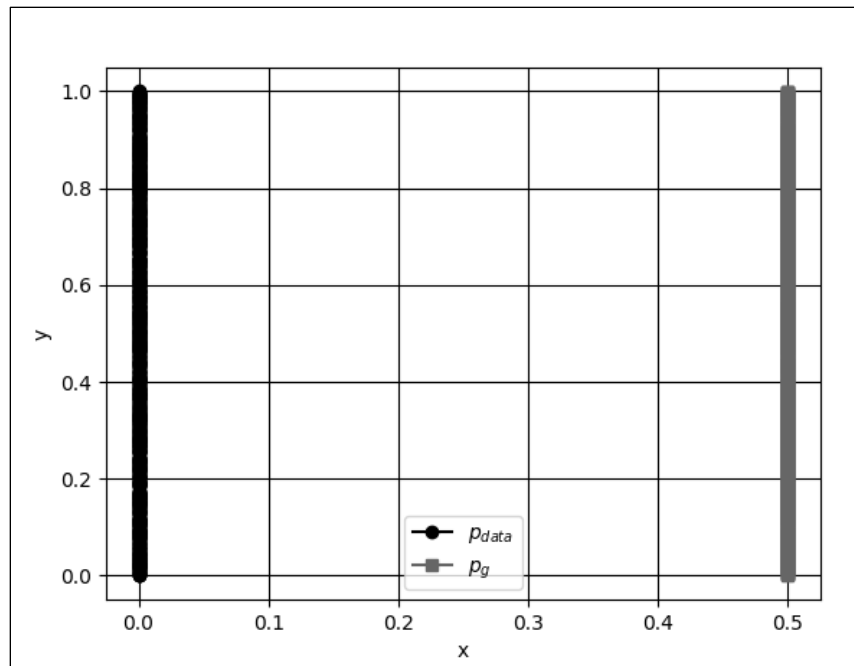
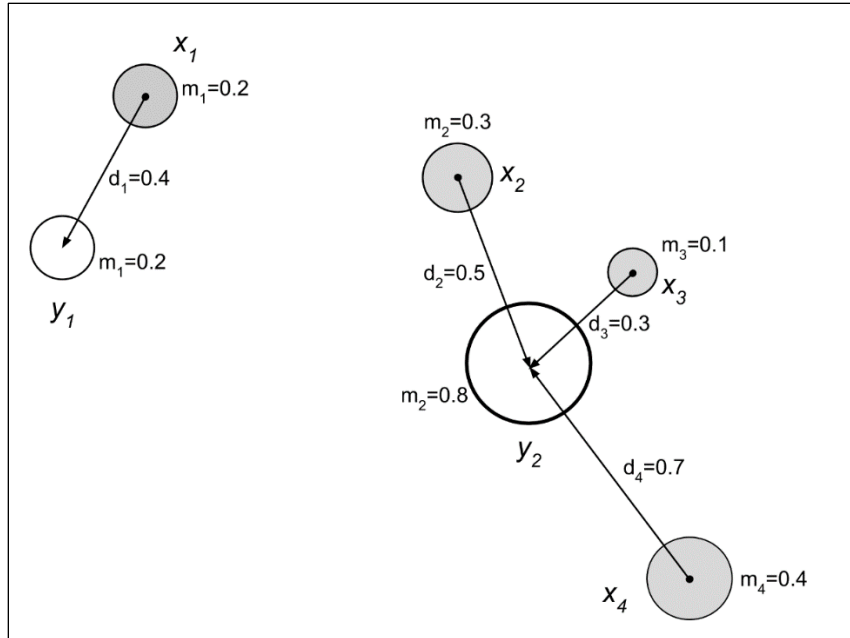

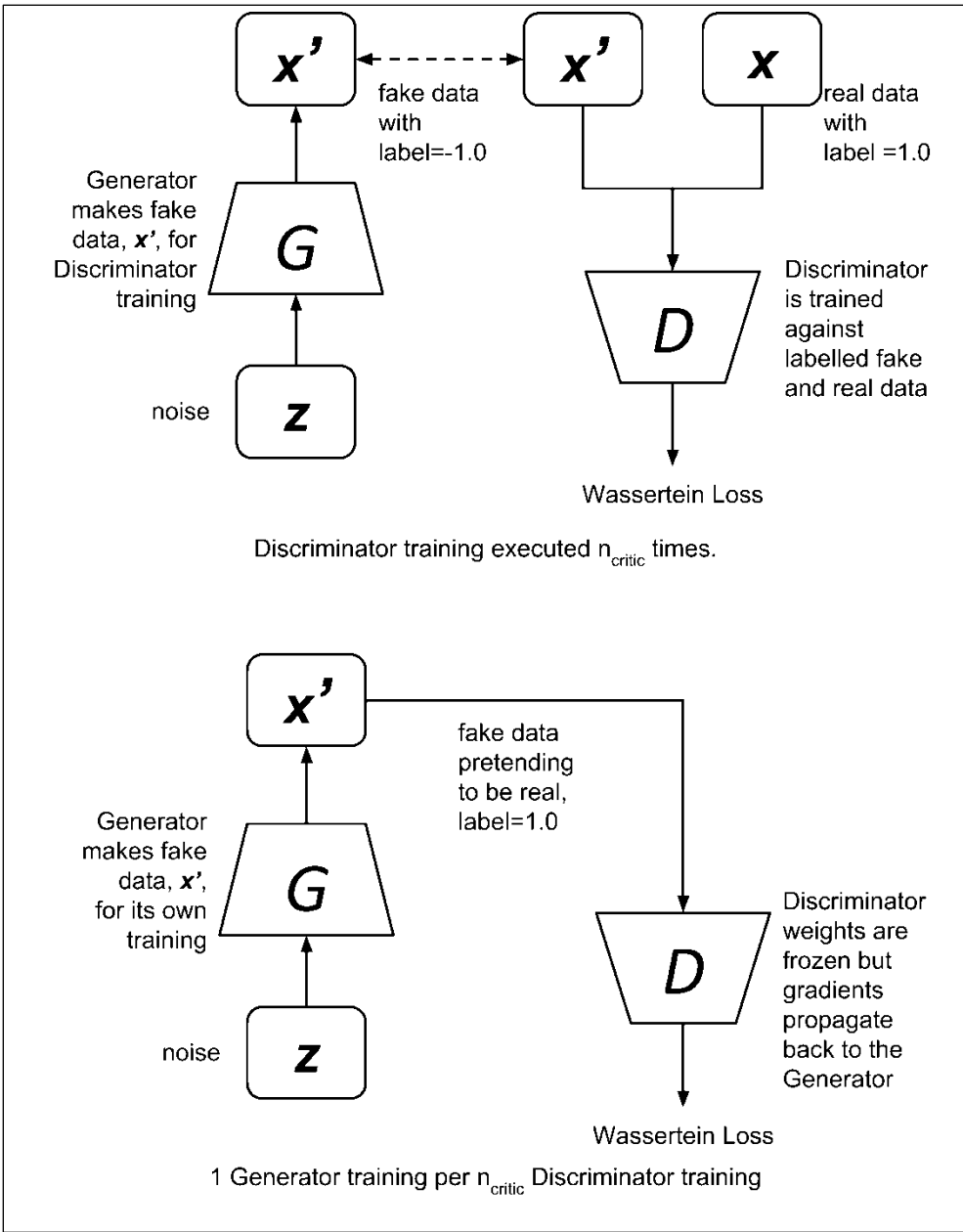



500

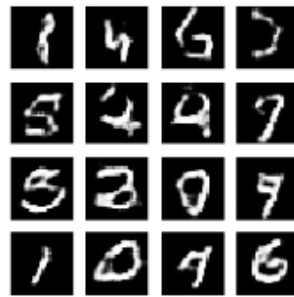

5000



10000



15000



20000



25000



30000



35000



40000

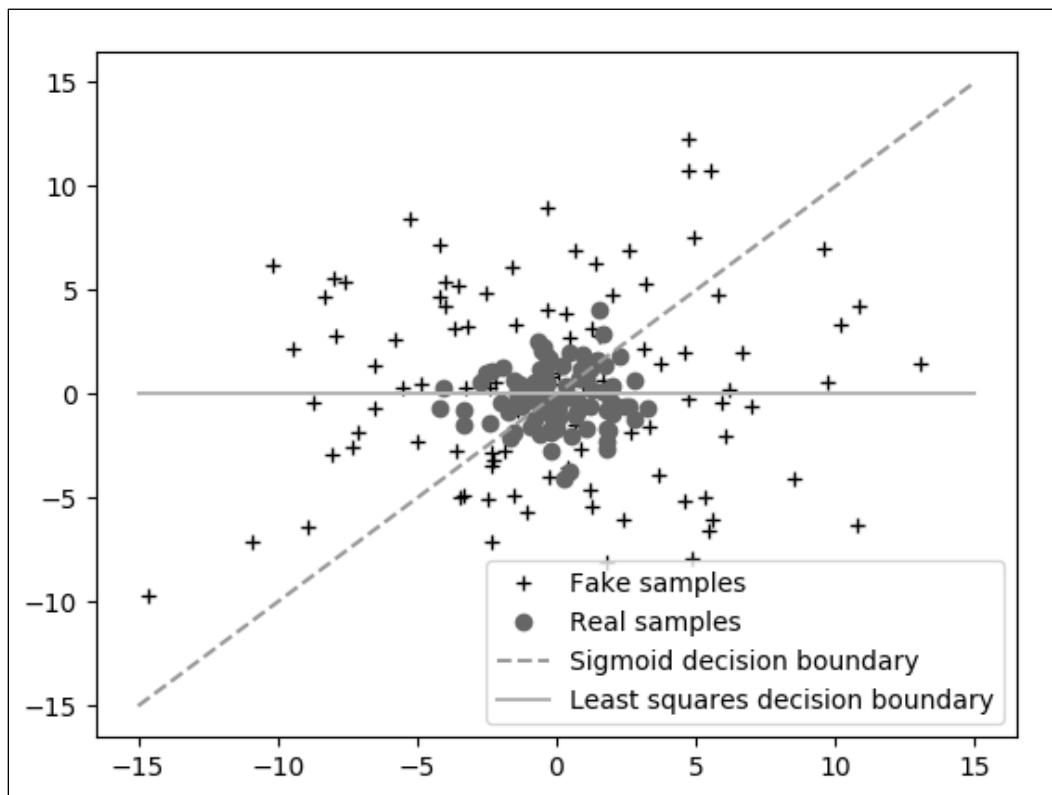
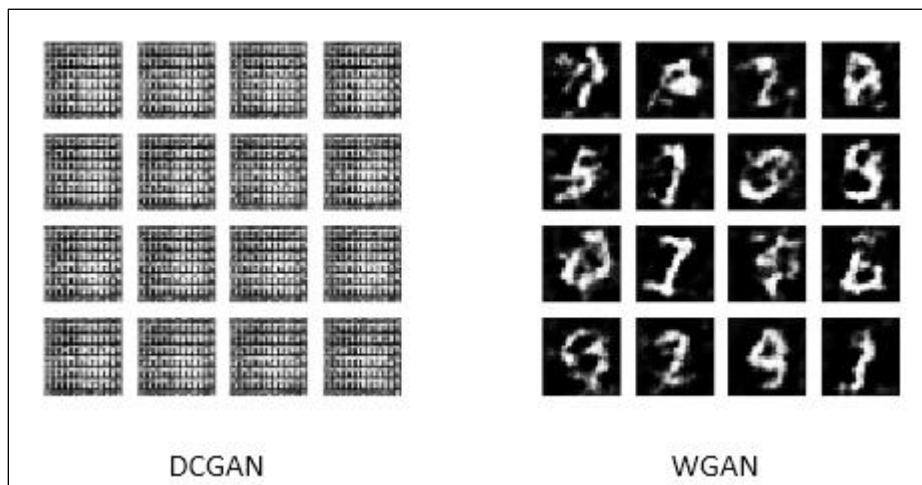



500

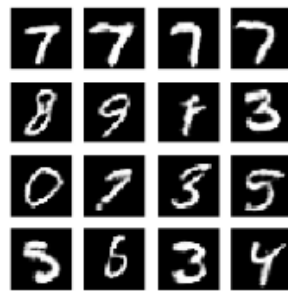

5000

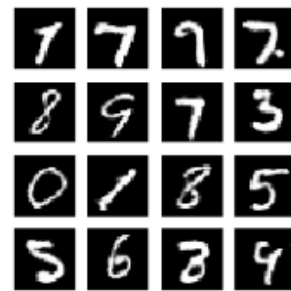

10000

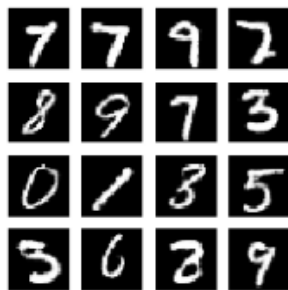

15000

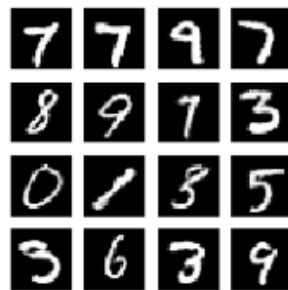

20000

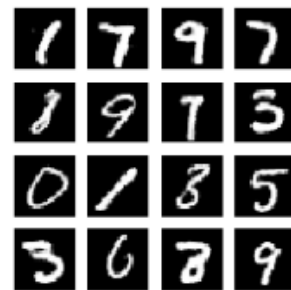

25000



30000

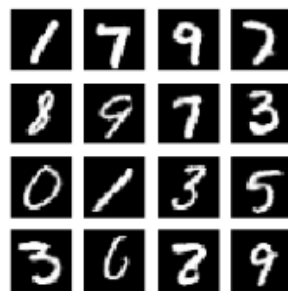

35000

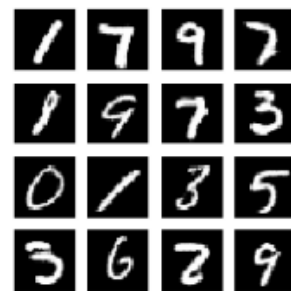

40000

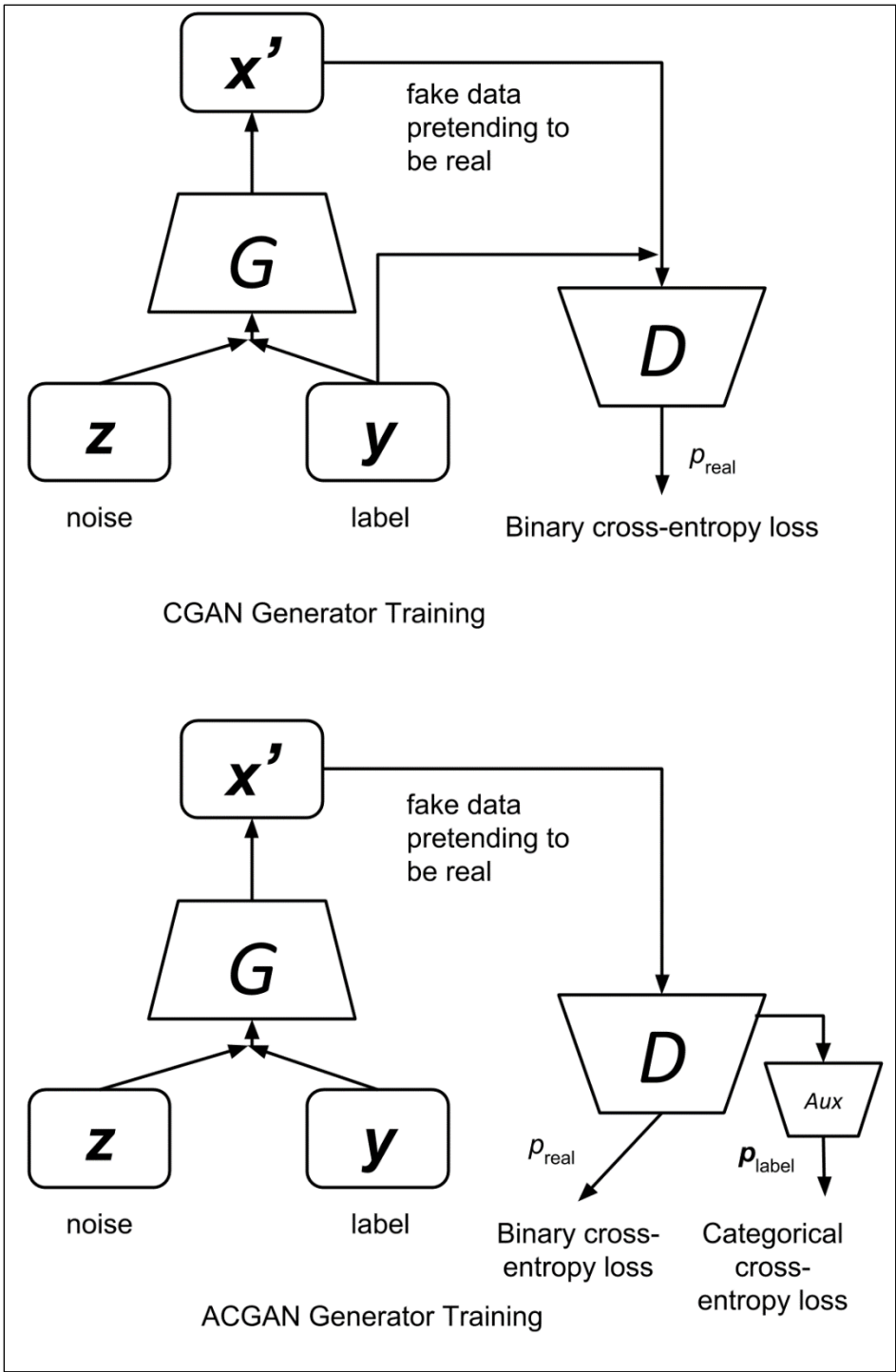

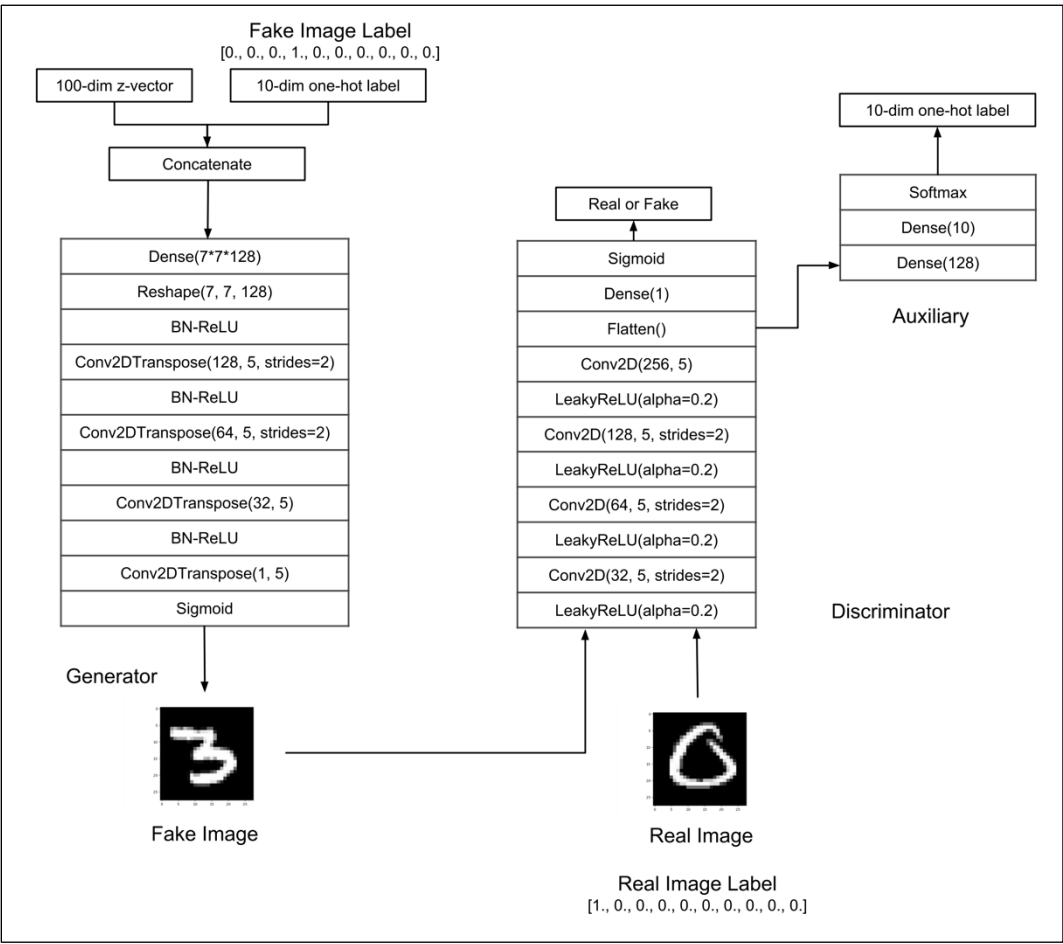



500



5000

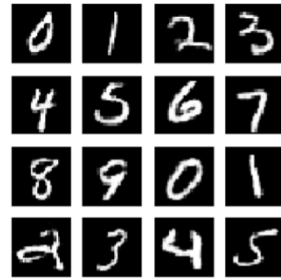

10000

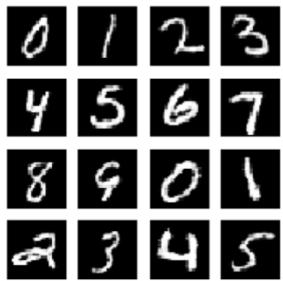

15000

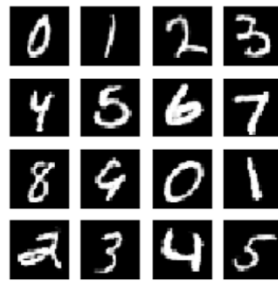

20000

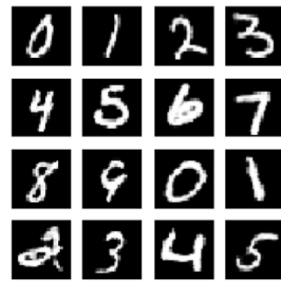

25000



30000

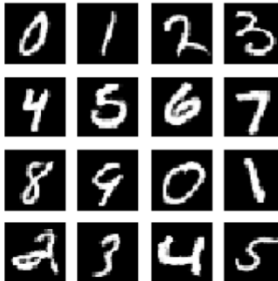

35000

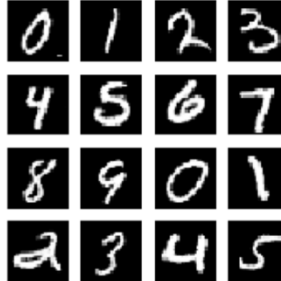

40000

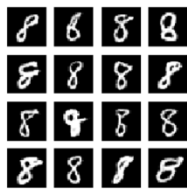
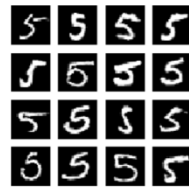
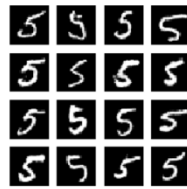
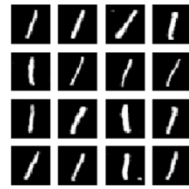
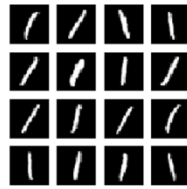

CGAN

ACGAN

CGAN

ACGAN

Chapter 6: Disentangled Representation GANs

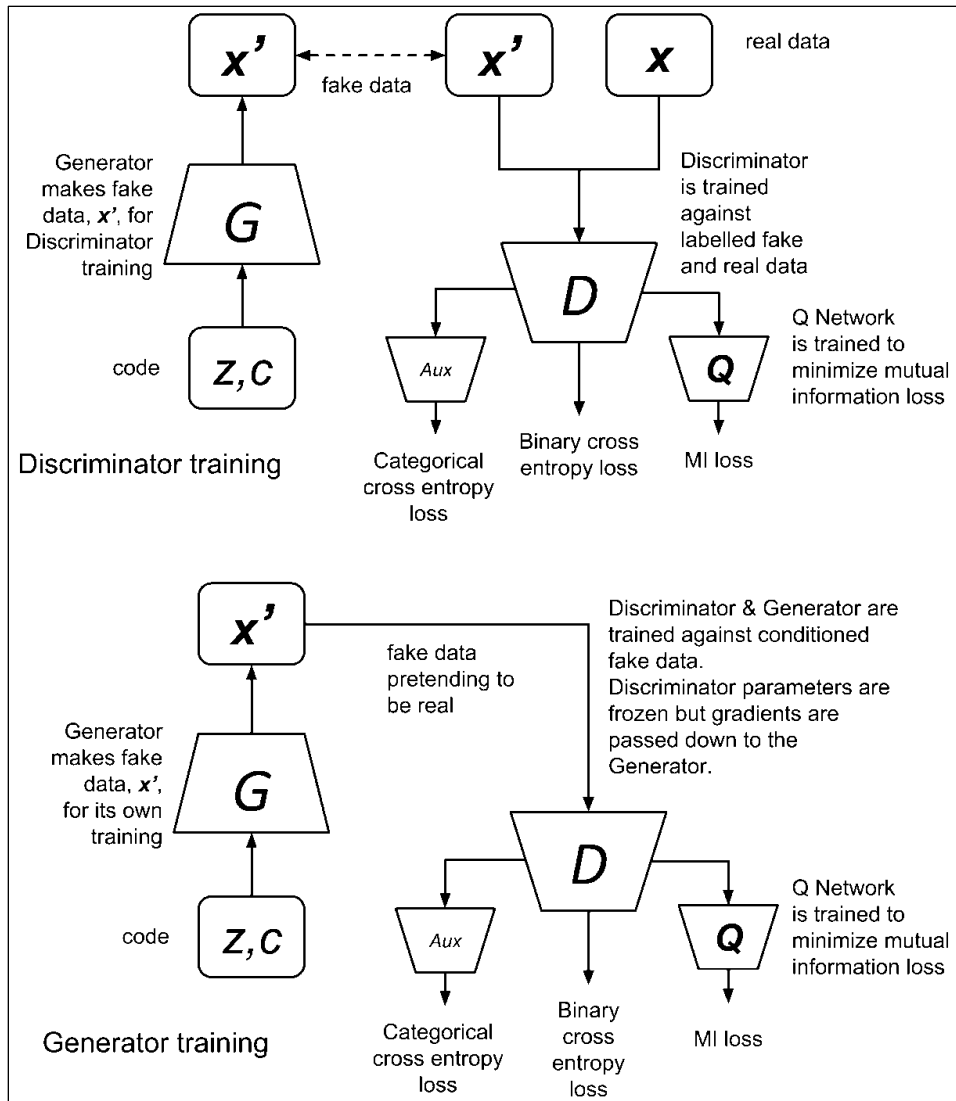
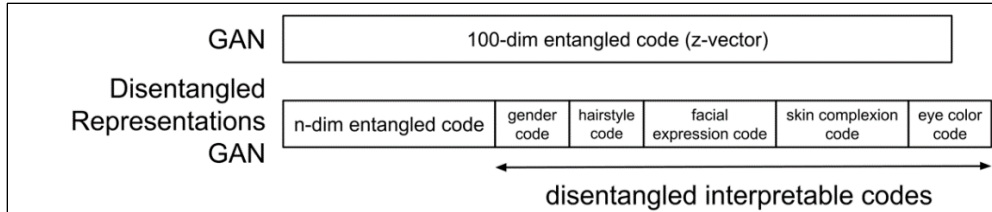

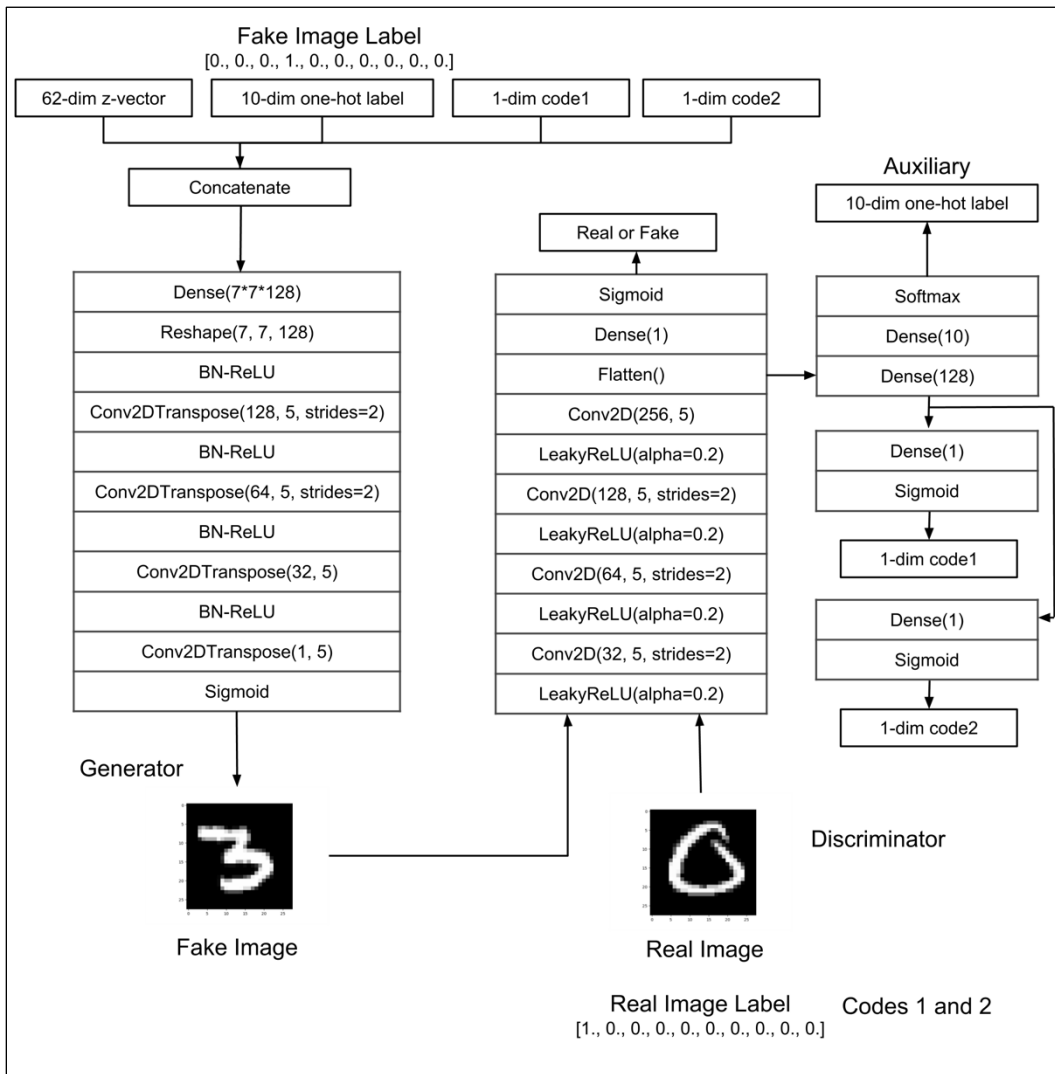
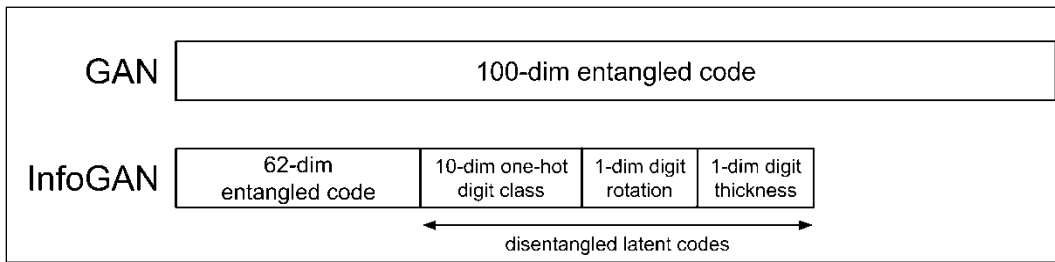

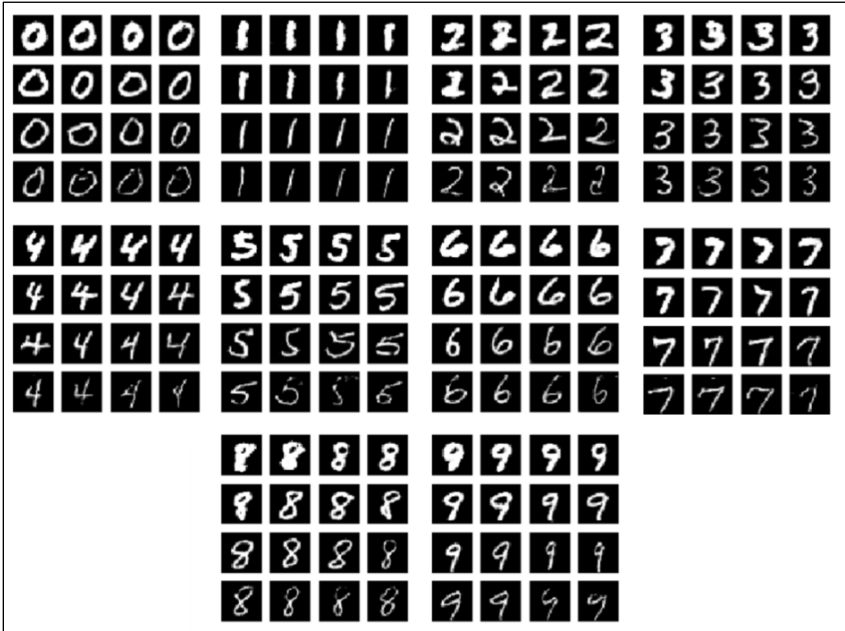
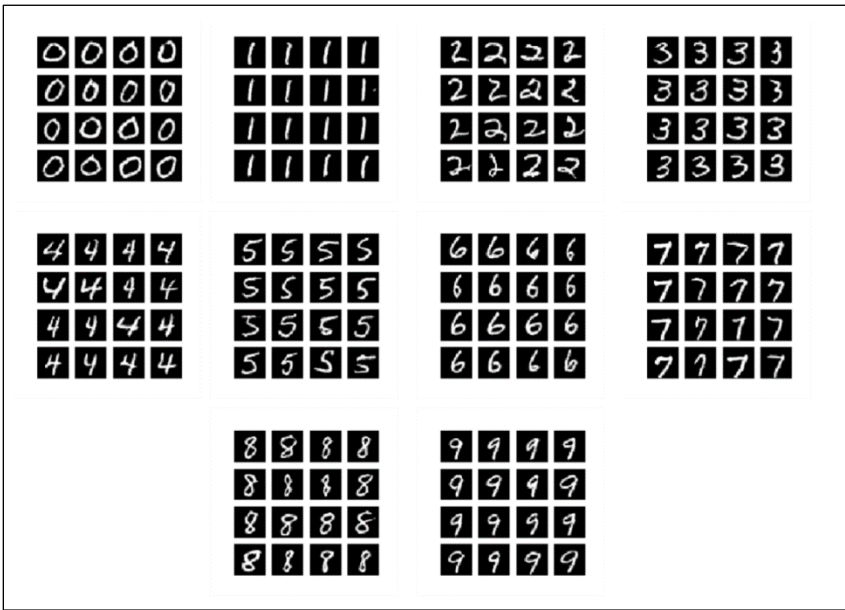

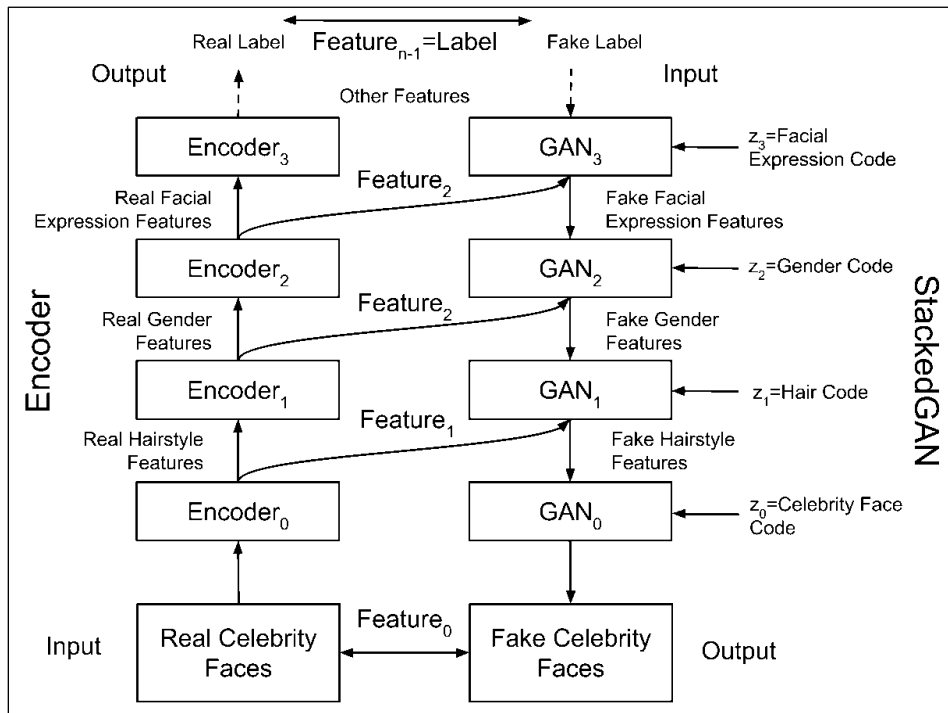
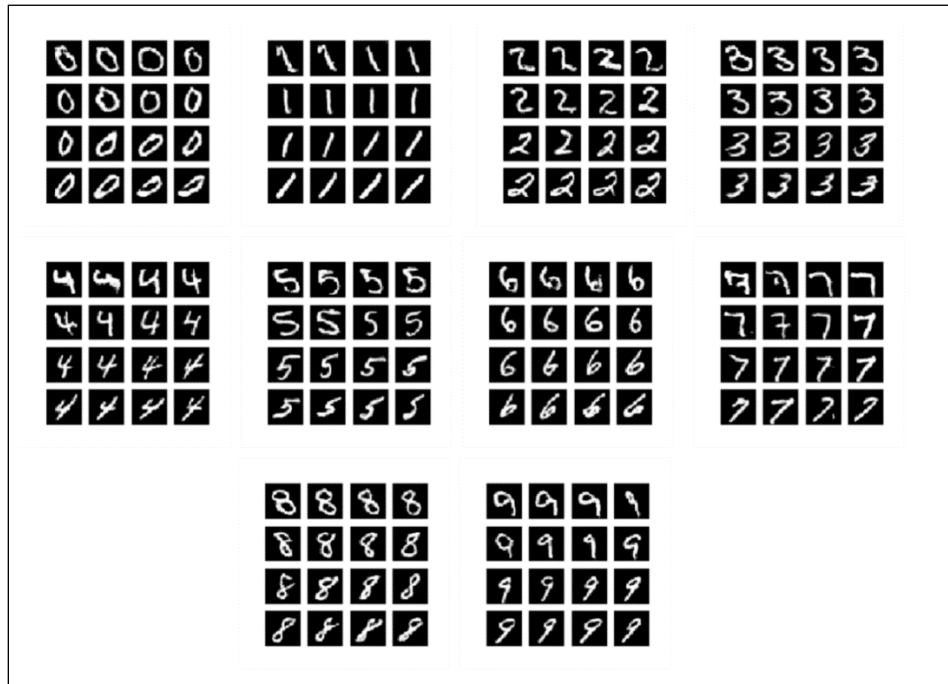

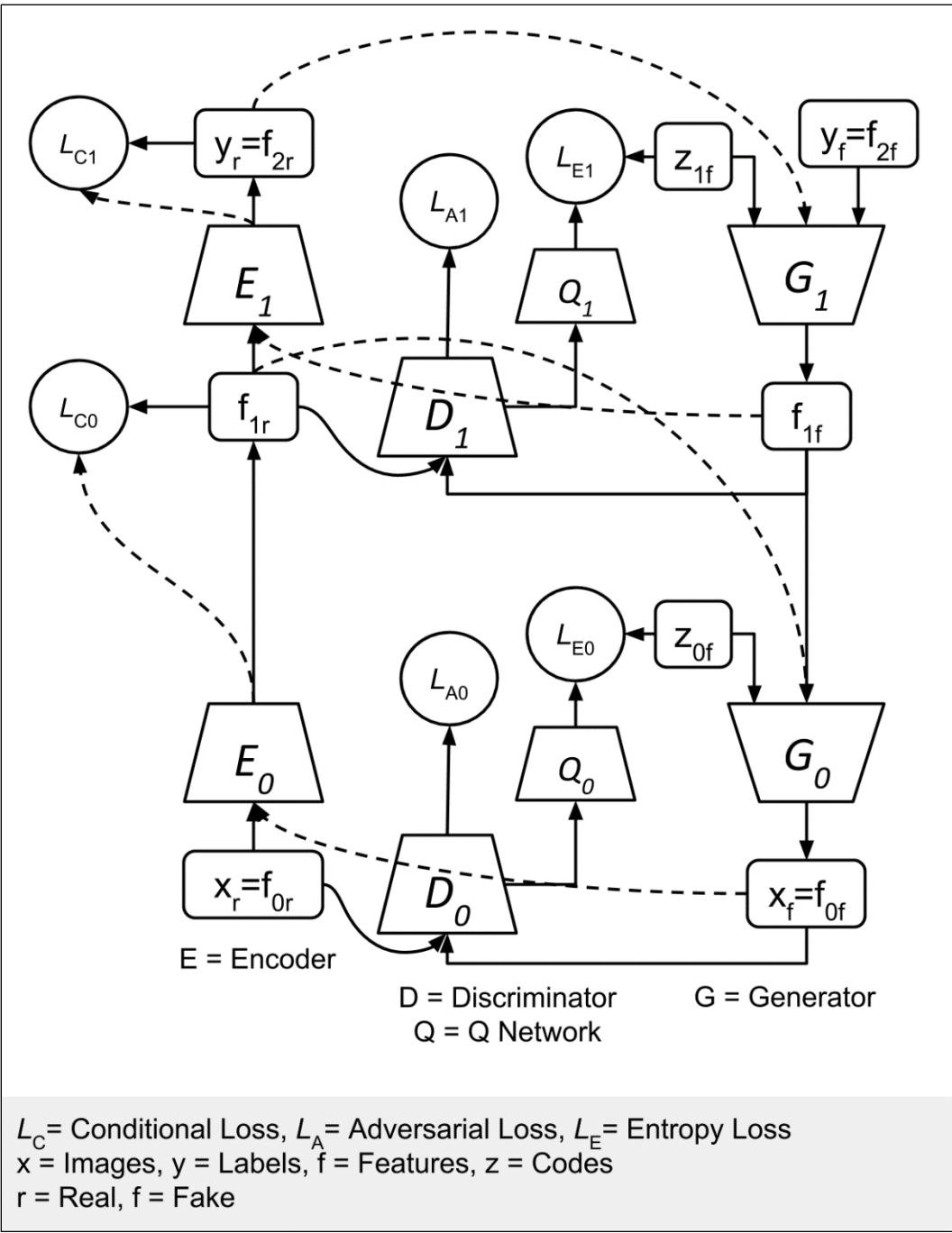

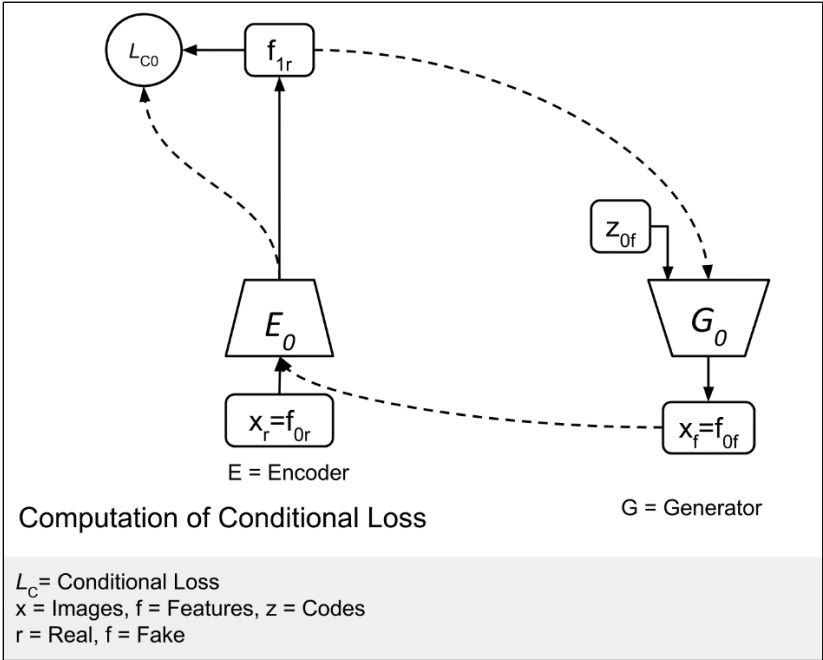
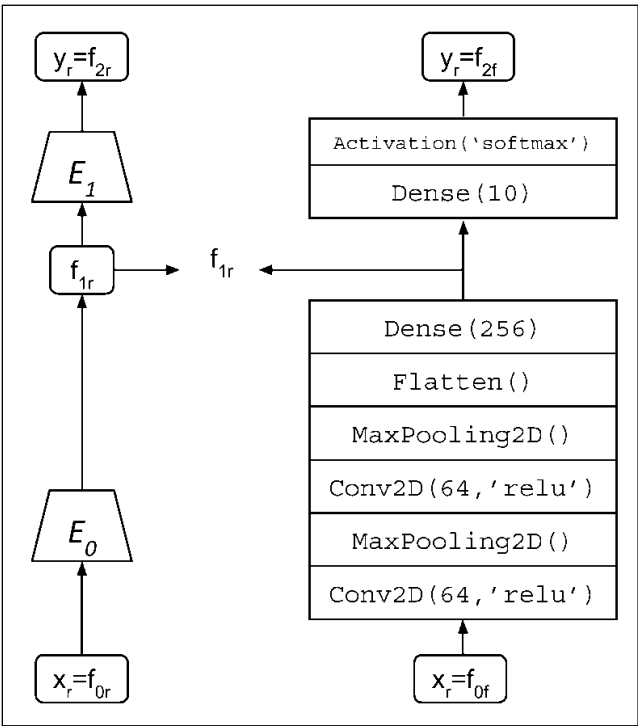

Computation of Entropy Loss

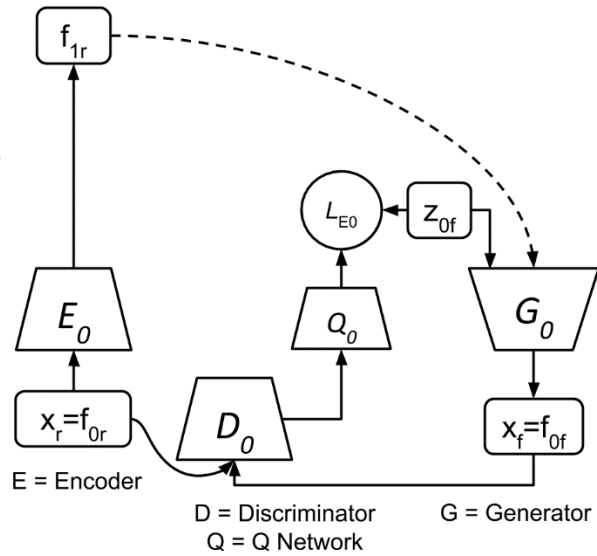

L_E = Entropy Loss
 x = Images, f = Features, z = Codes
 r = Real, f = Fake

Computation of Adversarial Loss

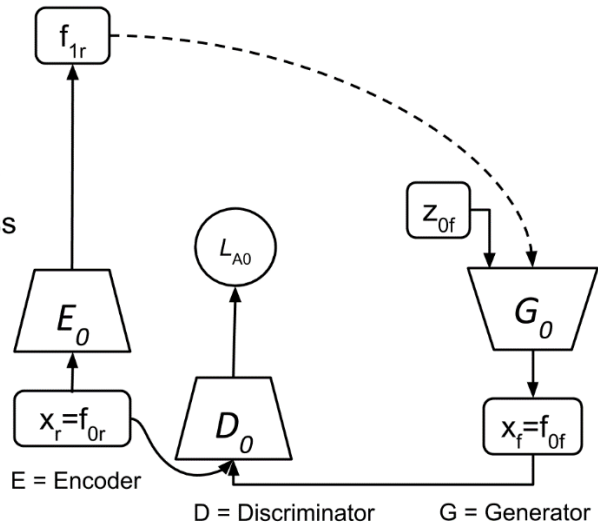

L_A = Adversarial Loss
 x = Images, f = Features, z = Codes
 r = Real, f = Fake

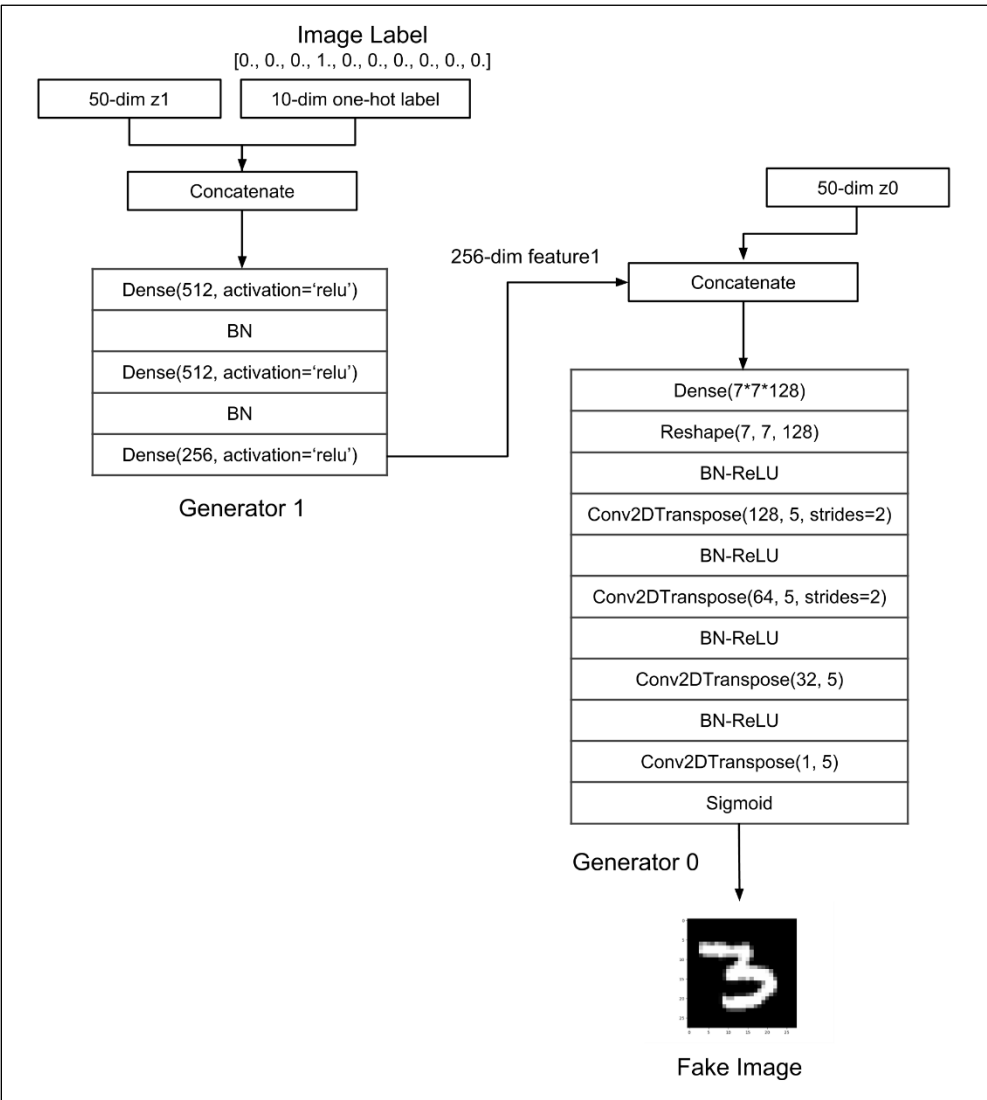

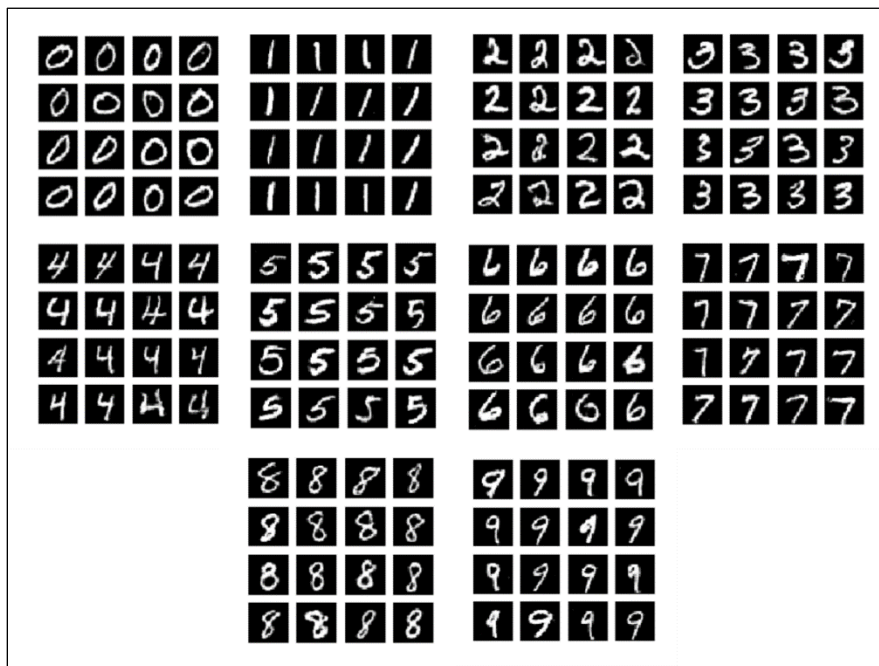
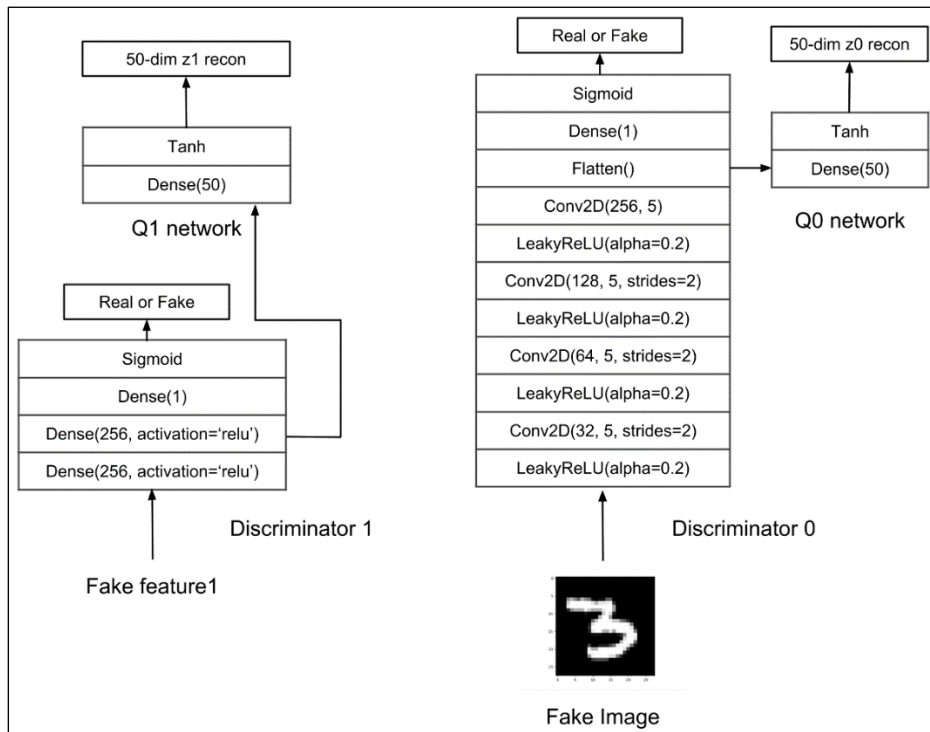

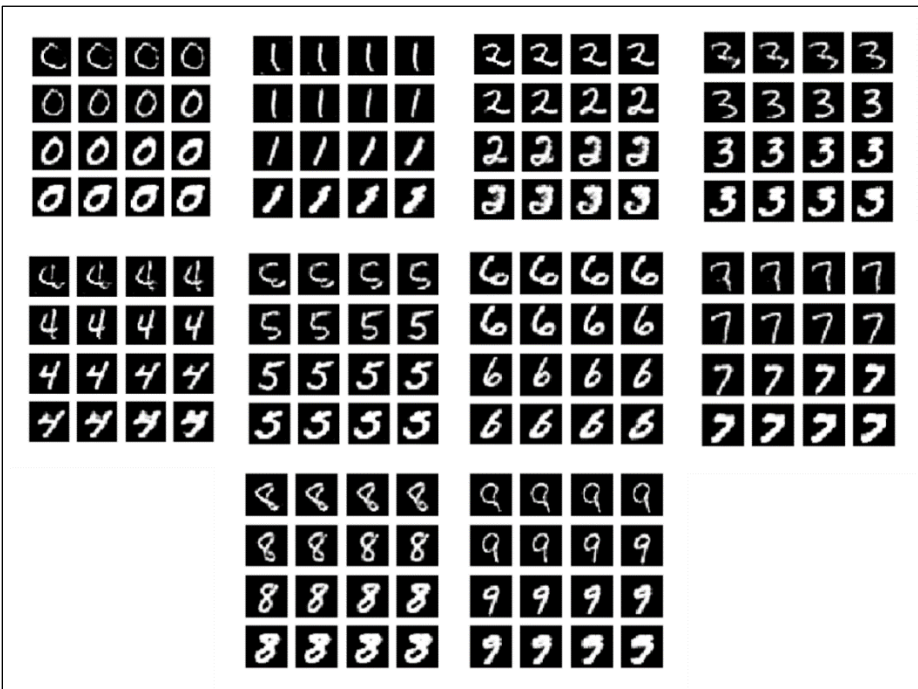
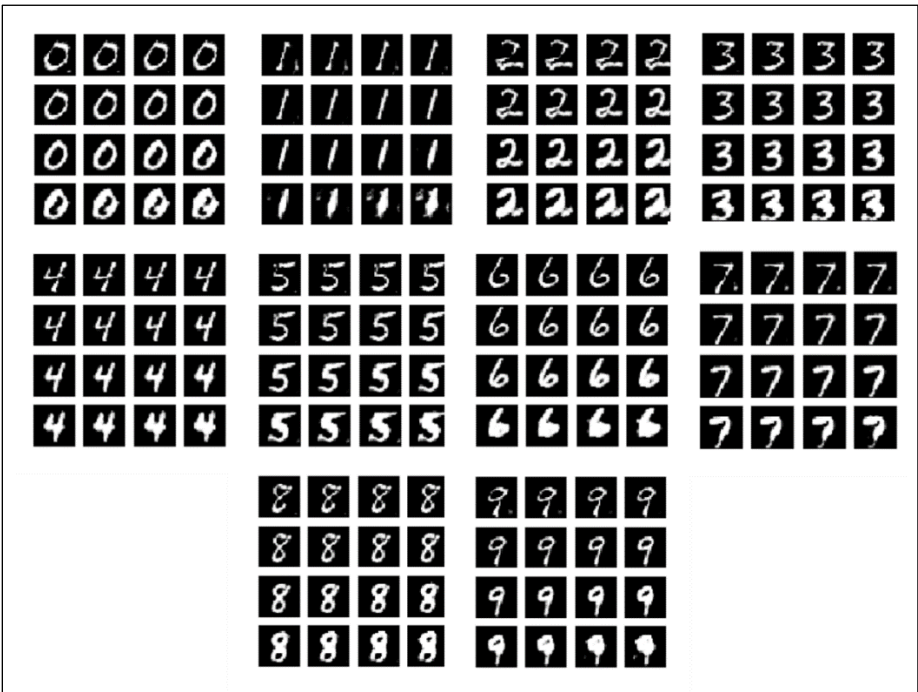

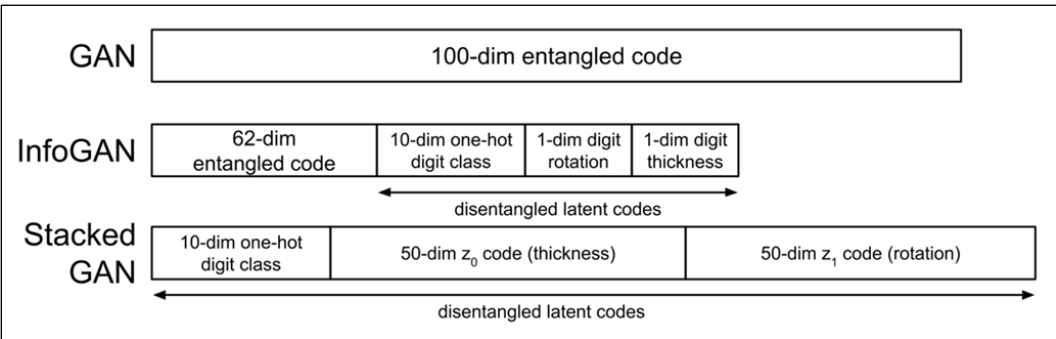

Chapter 7: Cross-Domain GANs



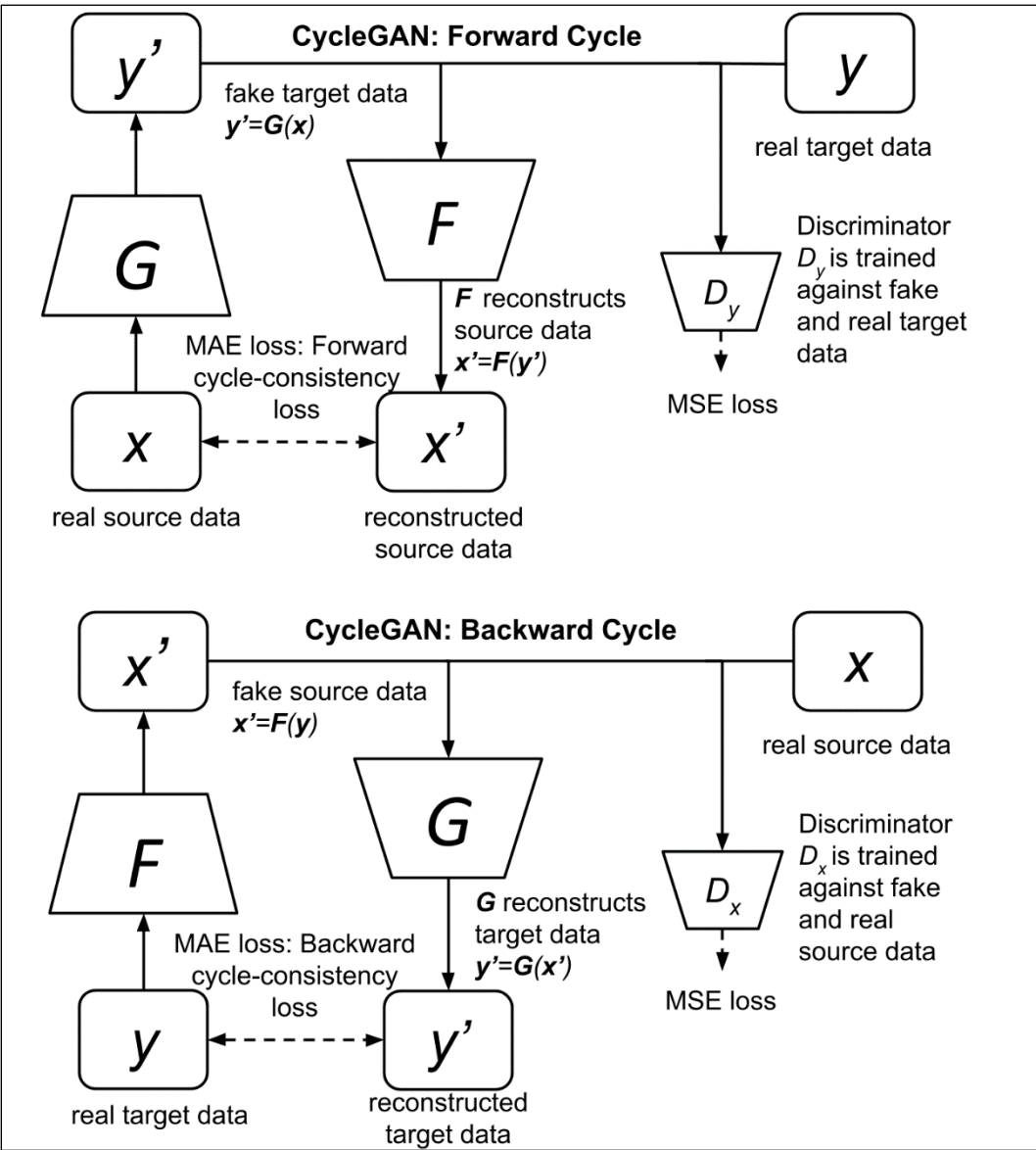

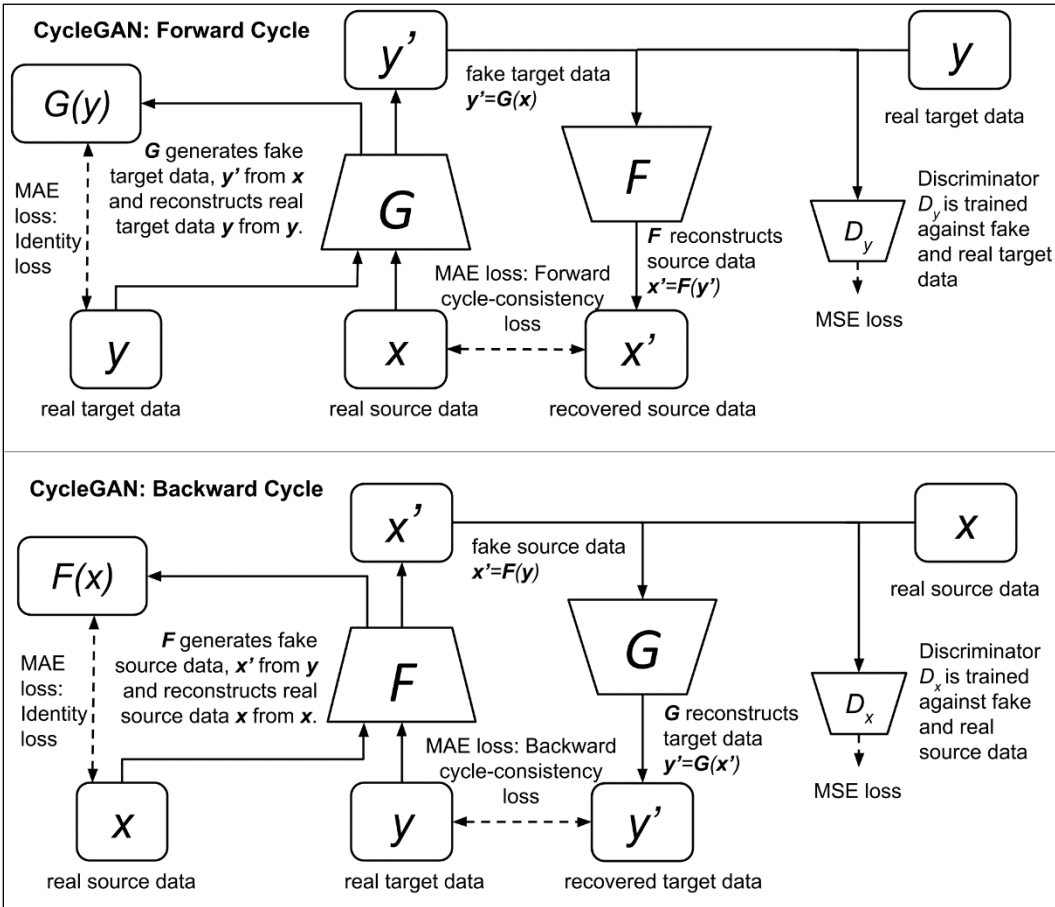

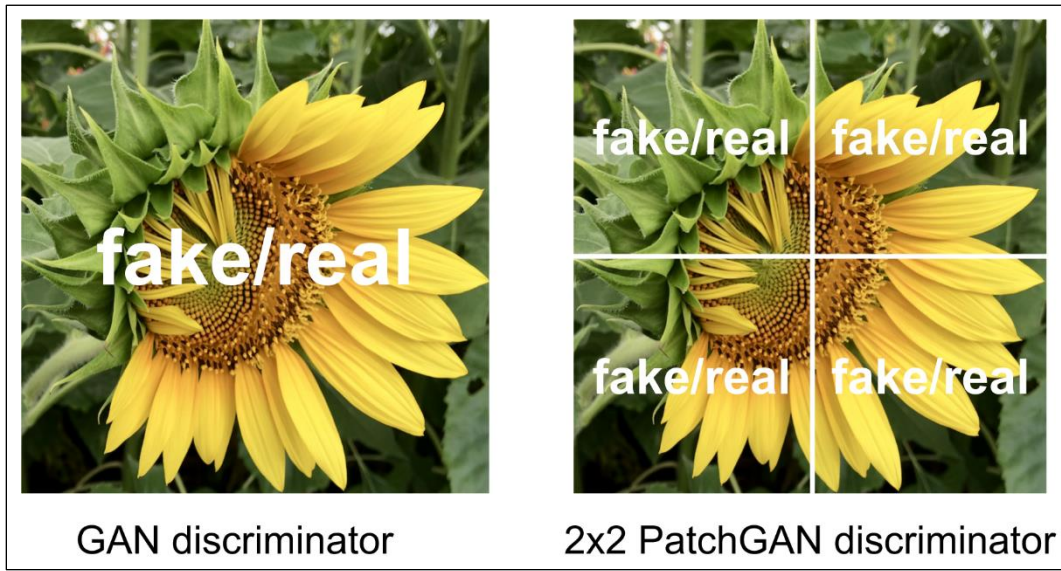
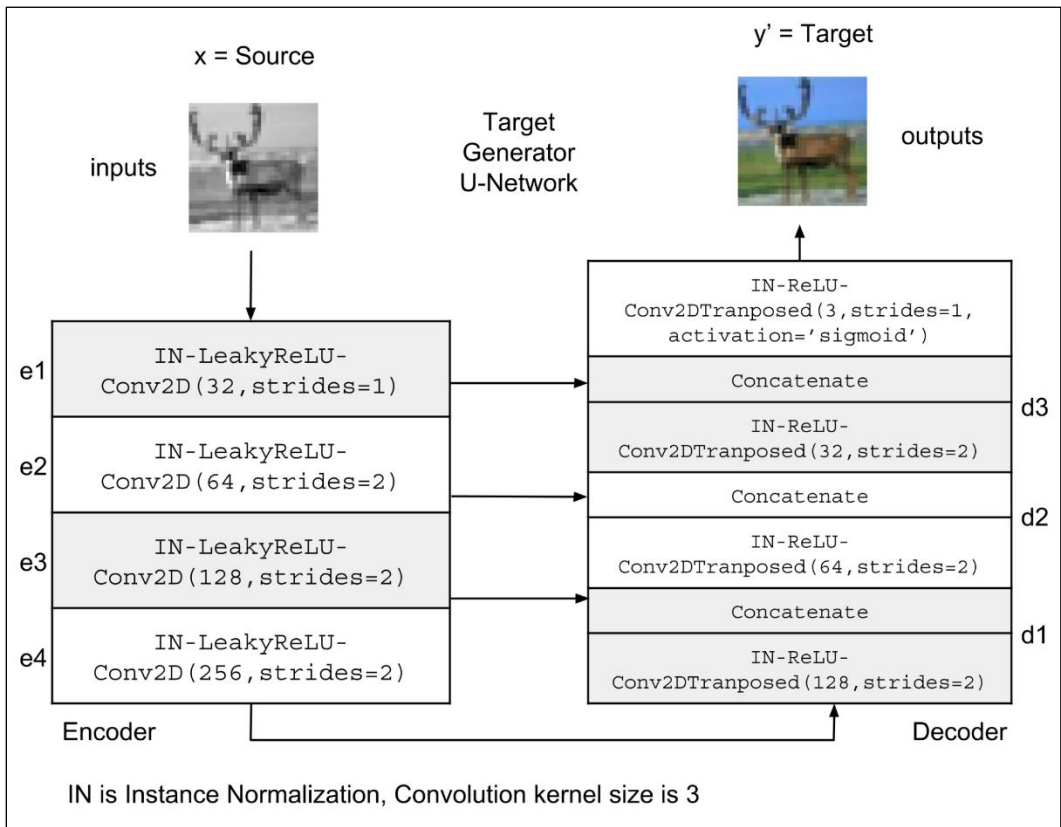

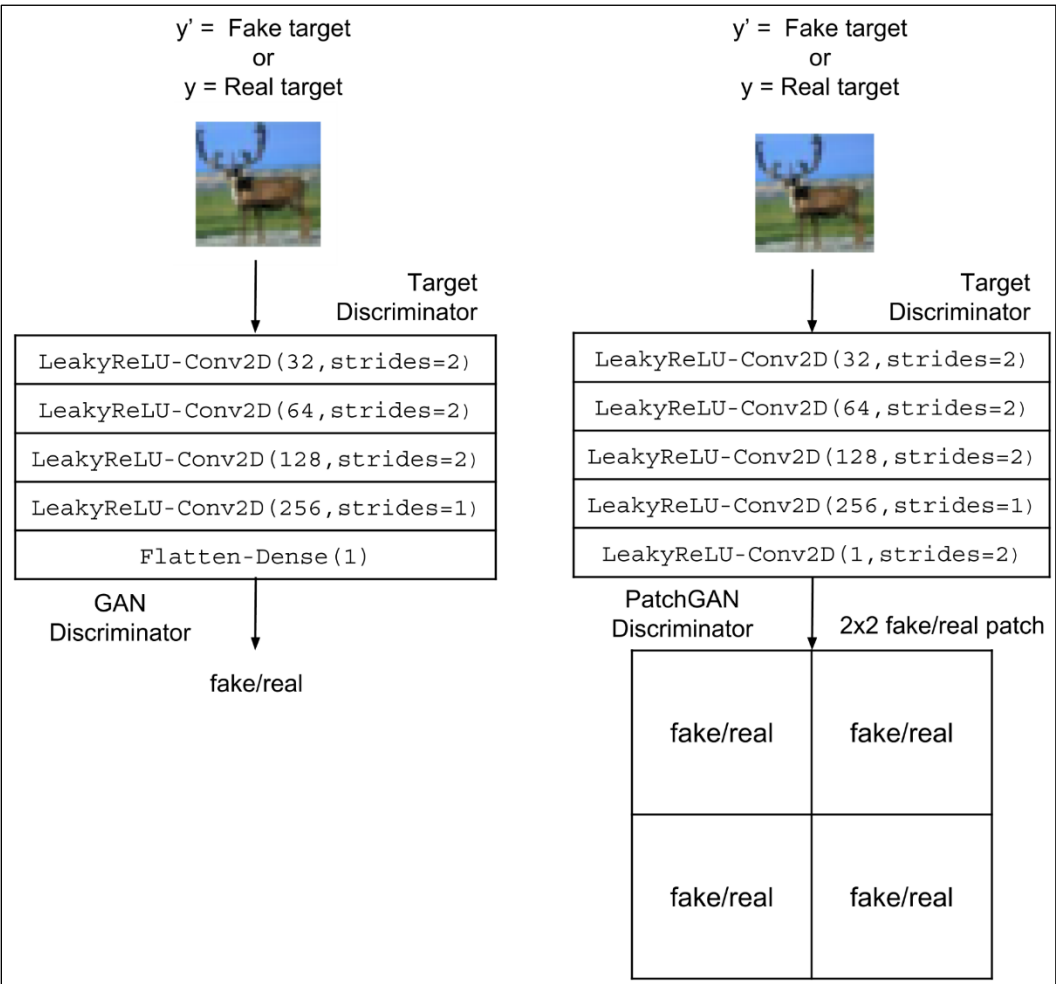

CIFAR10 test target images

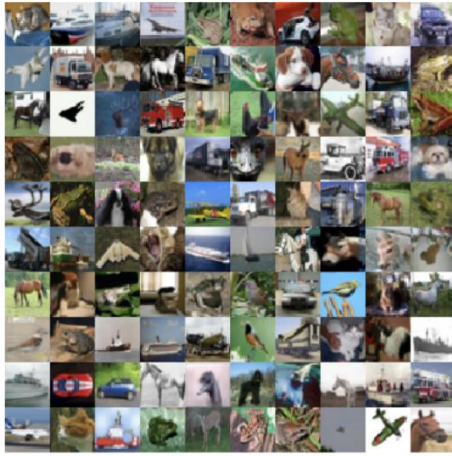

Ground Truth

Colorized test images (Predicted)

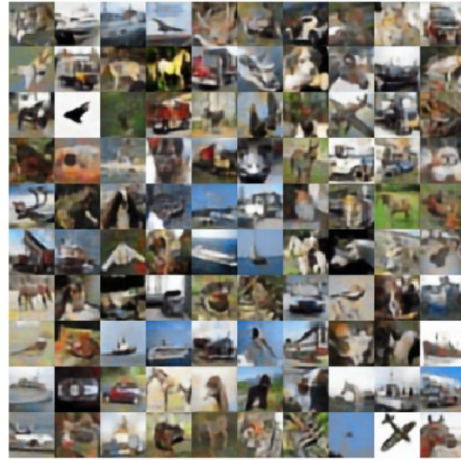

Colorization by AutoEncoder

CIFAR10 predicted target images. Step: 100,000 CIFAR10 predicted target images. Step: 100,000



Colorization by CycleGAN

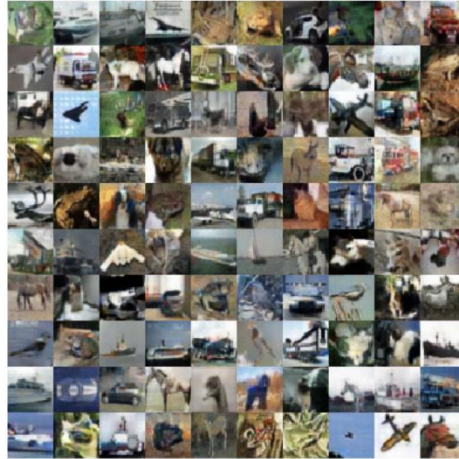

Colorization by CycleGAN w/ PatchGAN

CIFAR10 test source images



Ground Truth

CIFAR10 predicted source images. Step: 100,000



RGB to Grayscale by CycleGAN

CIFAR10 predicted source images. Step: 100,000



RGB to Grayscale by CycleGAN w/
PatchGAN

MNIST test source images



MNIST Digits

SVHN test target images

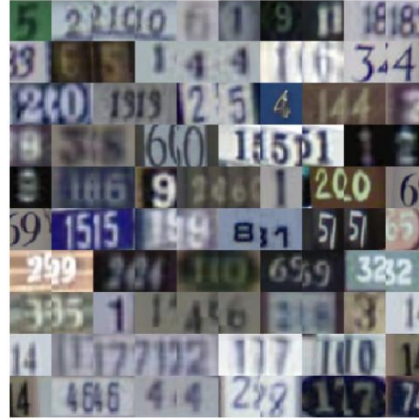

Street View House Number

MNIST test source images



MNIST Digits

SVHN predicted target images. Step: 100,000



MNIST in SVHN domain

SVHN predicted target images. Step: 100,000



MNIST in SVHN domain w/
PatchGAN

SVHN test target images



SVHN

MNIST predicted source images. Step: 100,000 MNIST predicted source images. Step: 100,000



SVHN in MNIST domain



SVHN in MNIST domain w/
PatchGAN

Test mnist source images



MNIST reconstructed source images.



MNIST to SVHN Forward Cycle

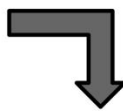

SVHN predicted target images.

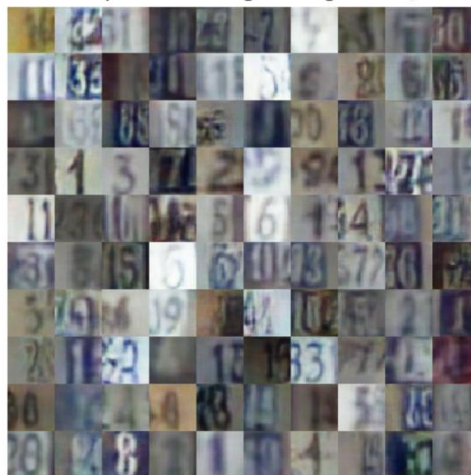

SVHN test target images



SVHN reconstructed target images.



SVHN to MNIST Backward Cycle



MNIST predicted source images.



Chapter 8: Variational Autoencoders (VAEs)

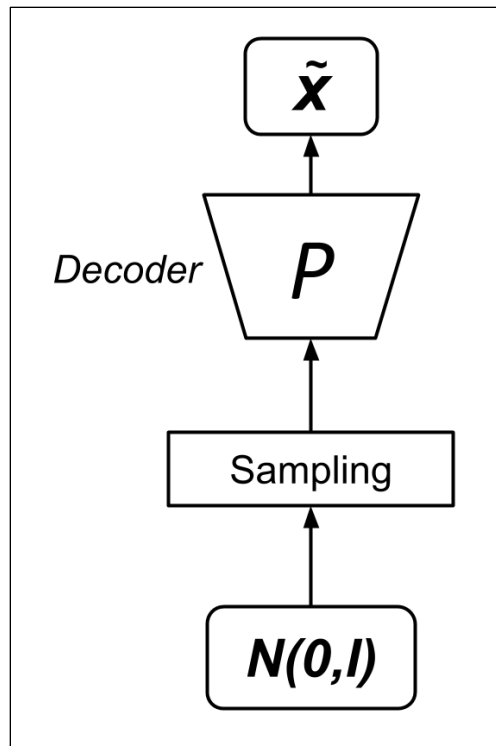
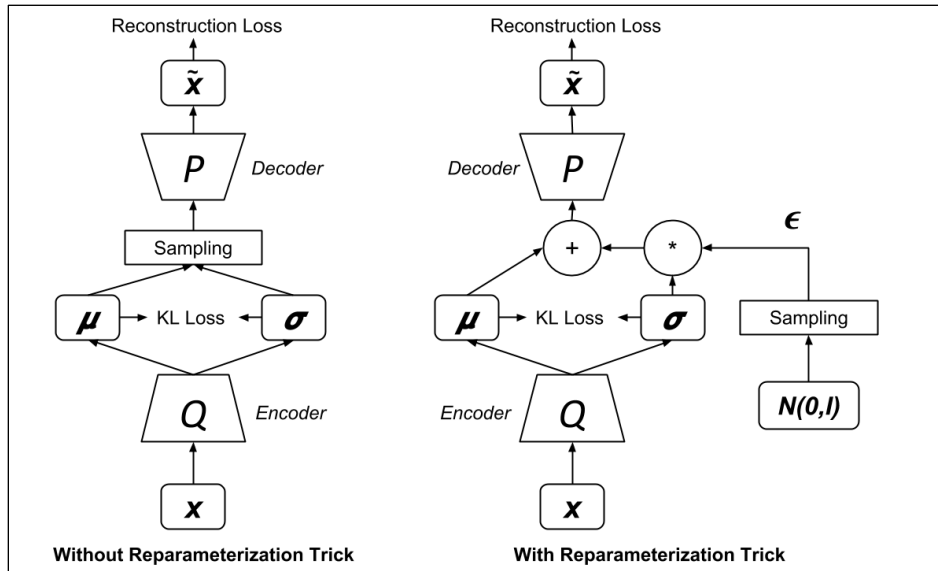

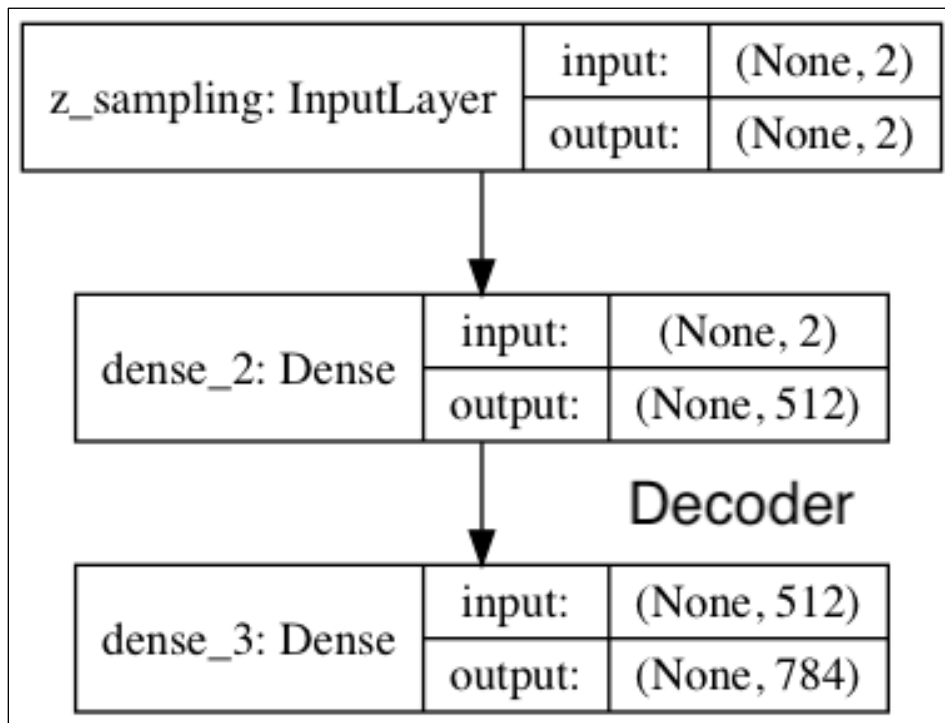
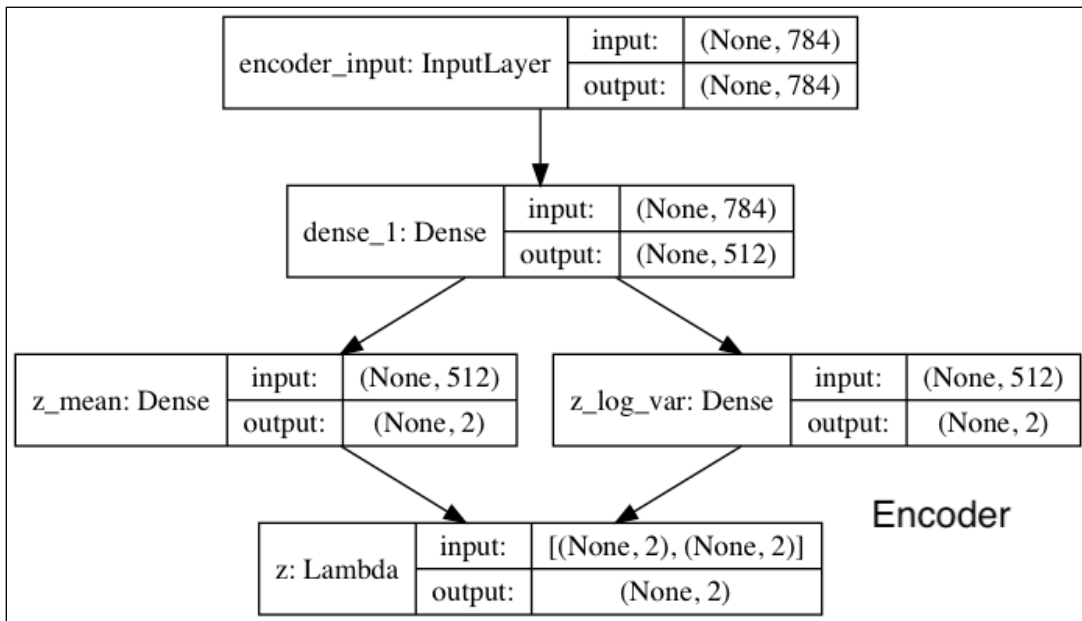

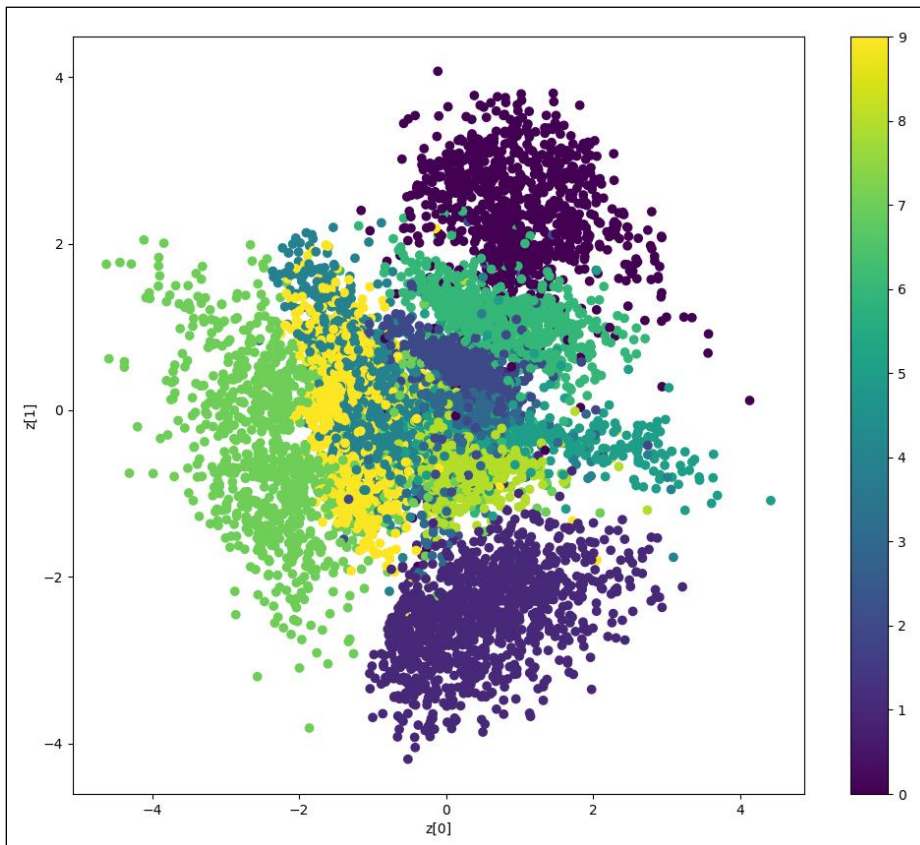
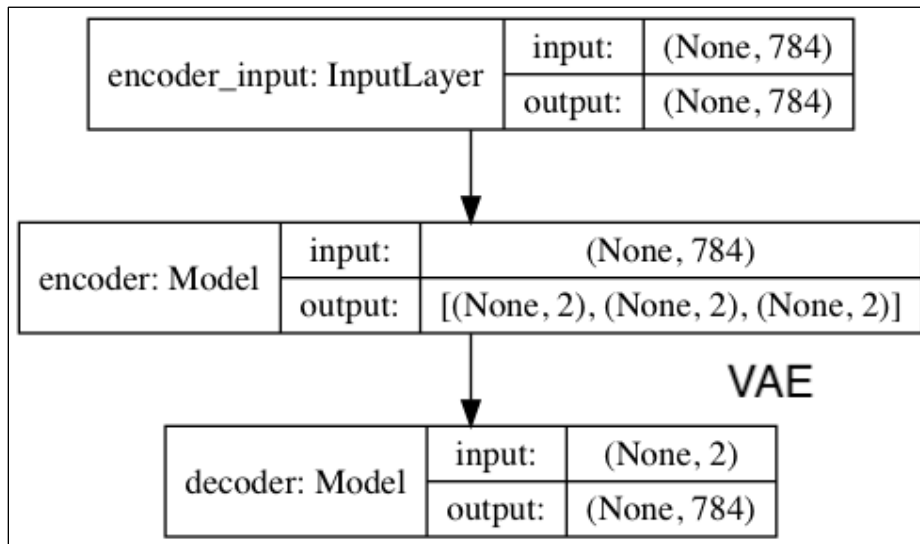

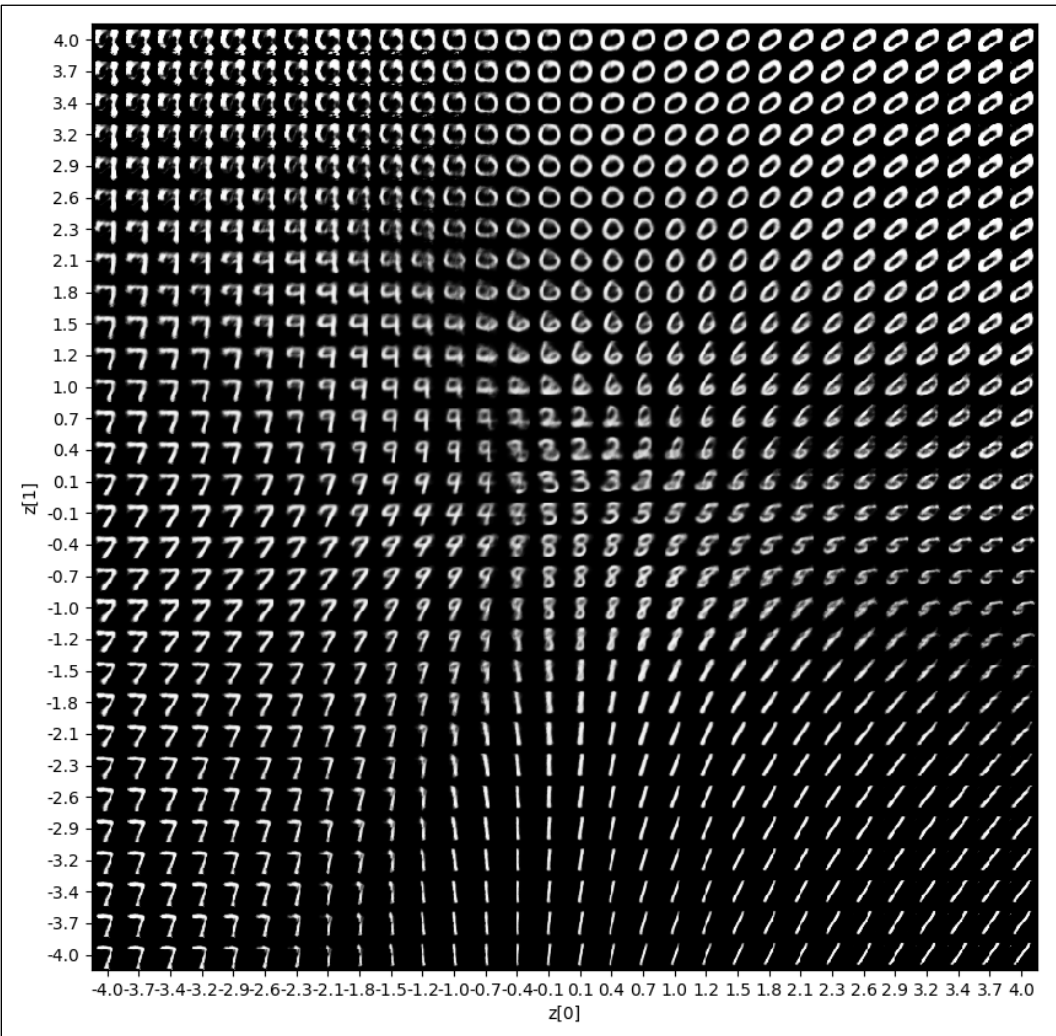

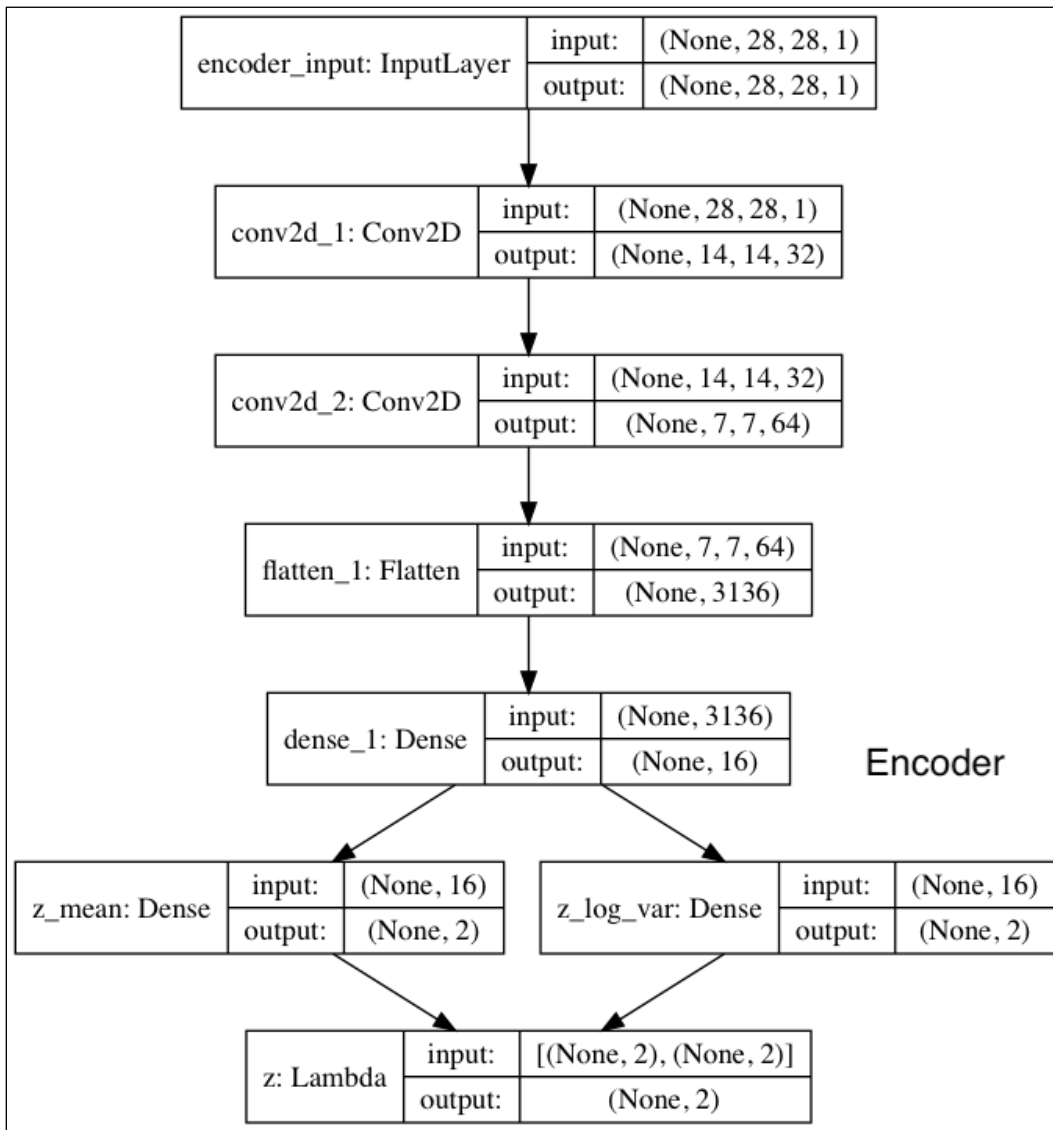

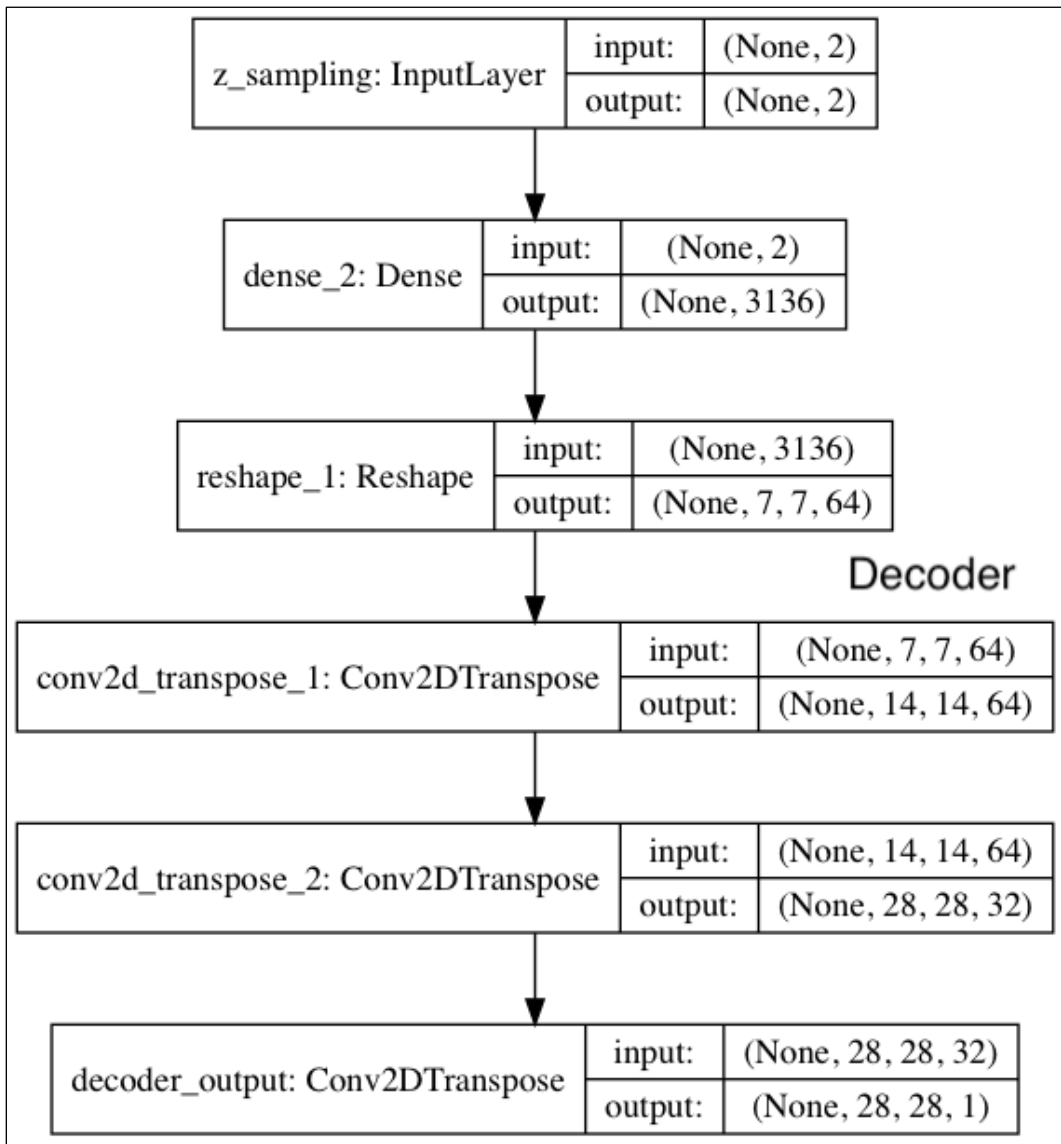

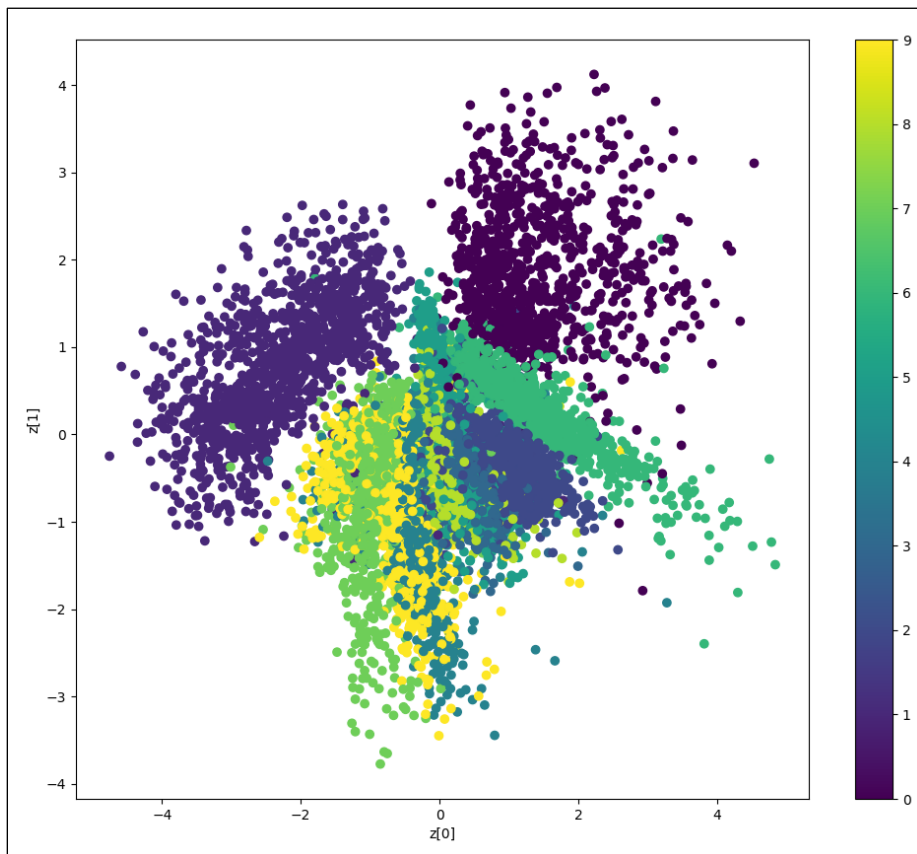
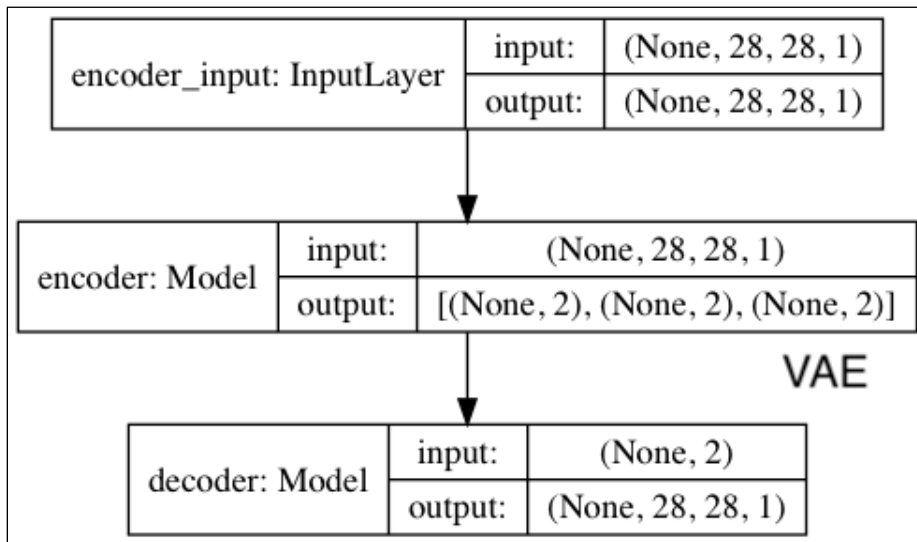

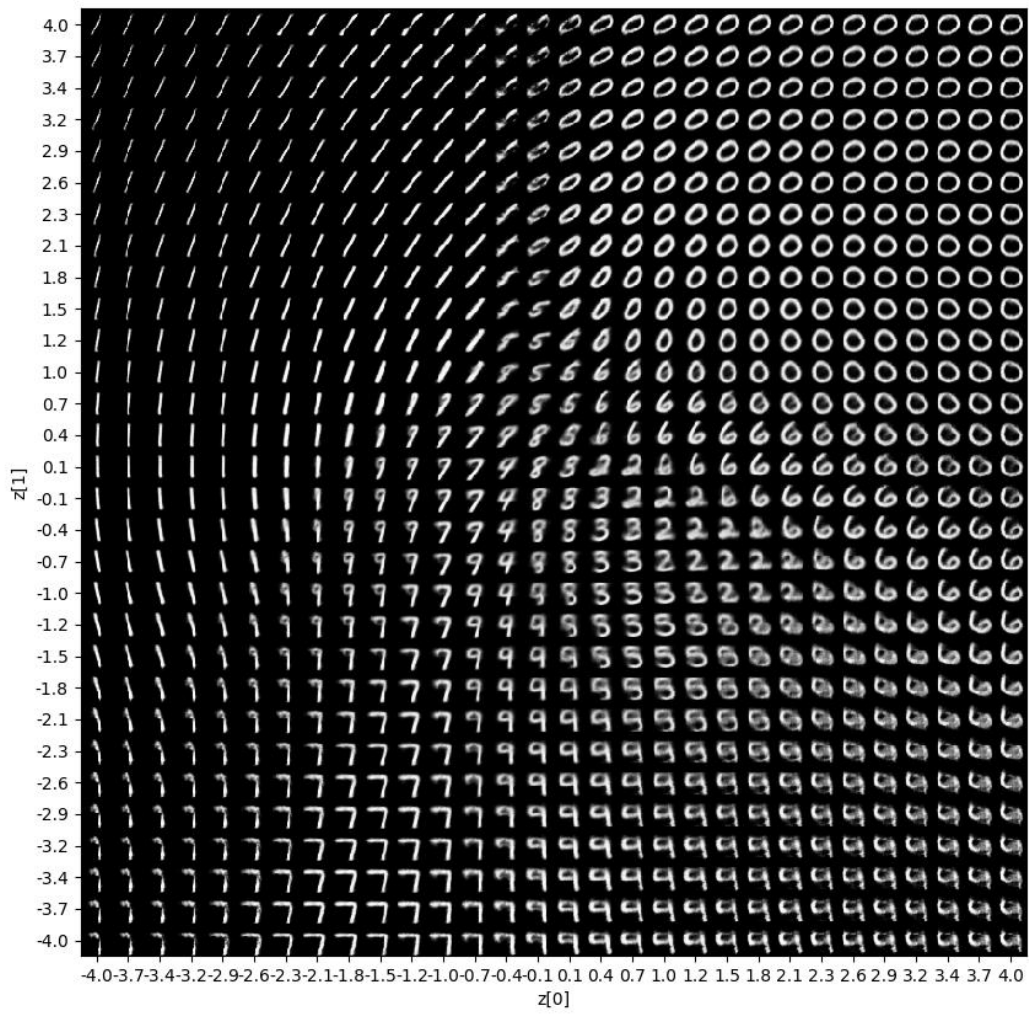

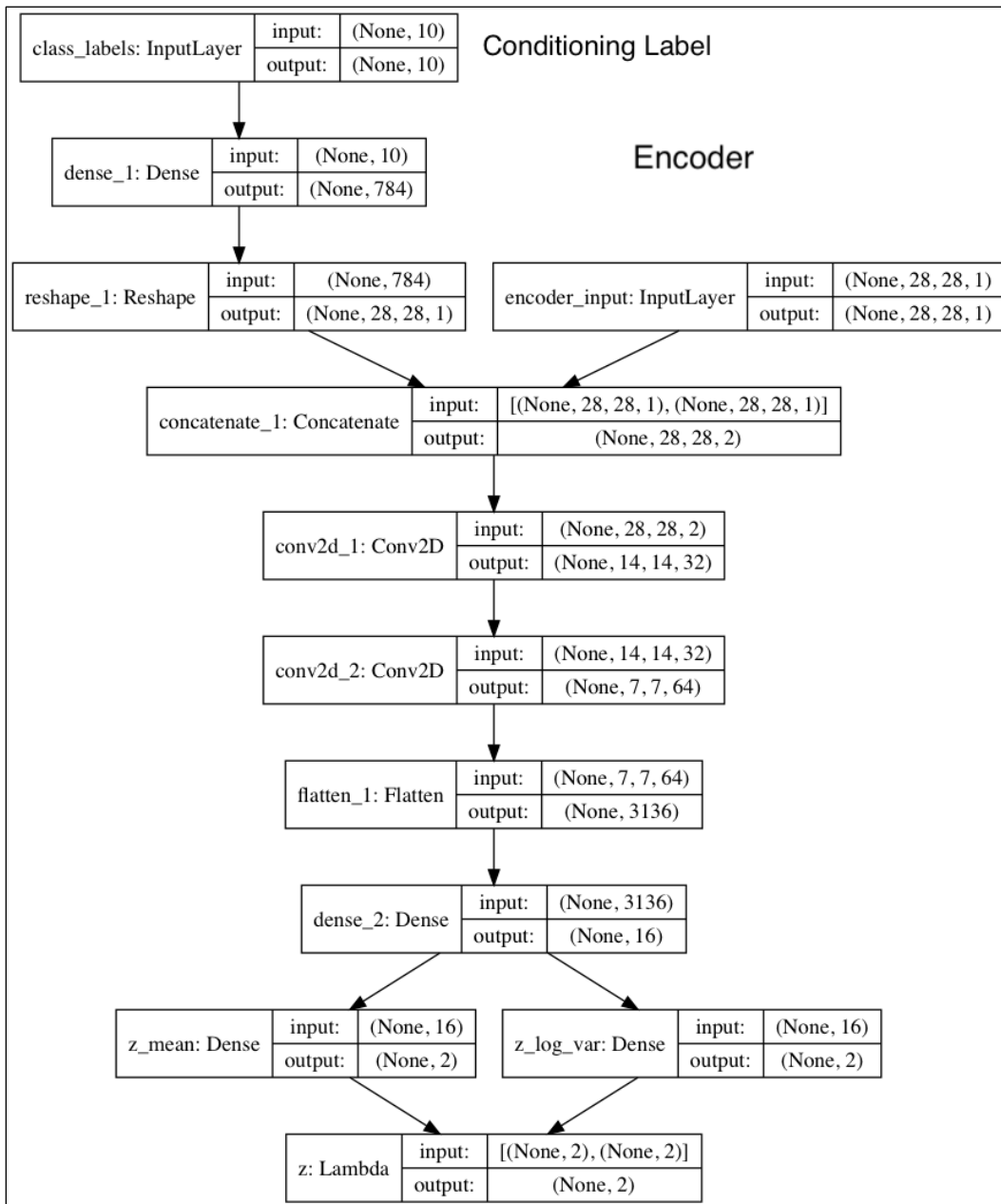

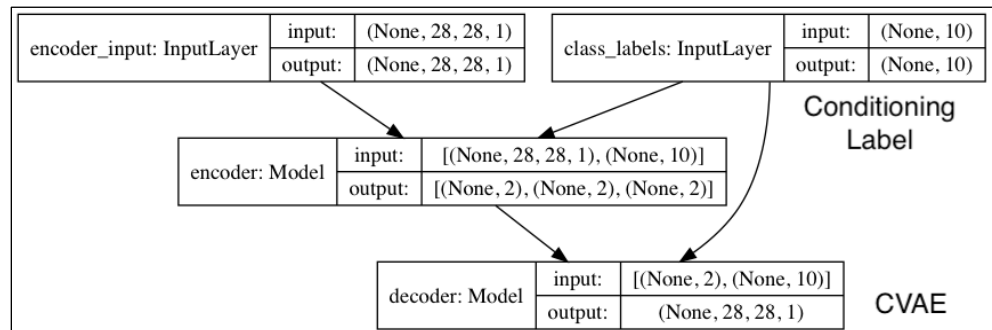
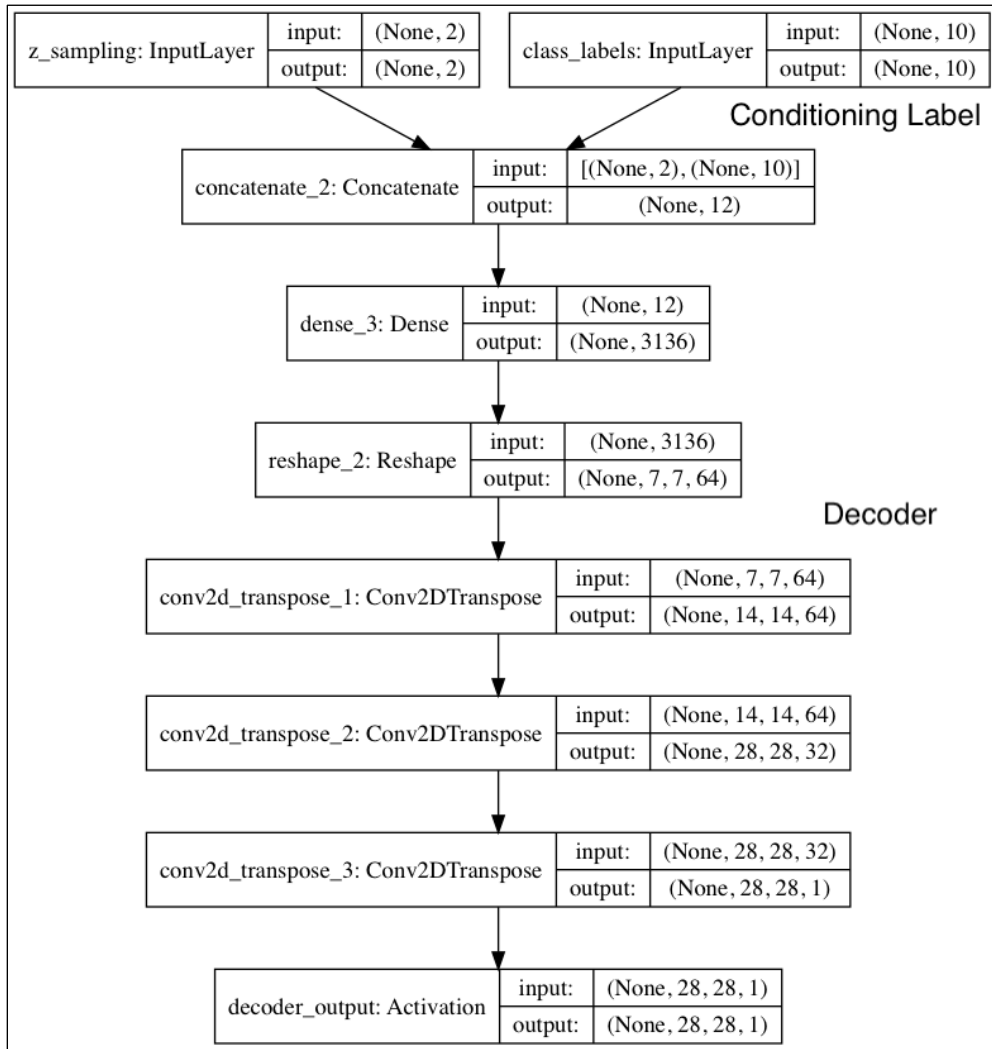

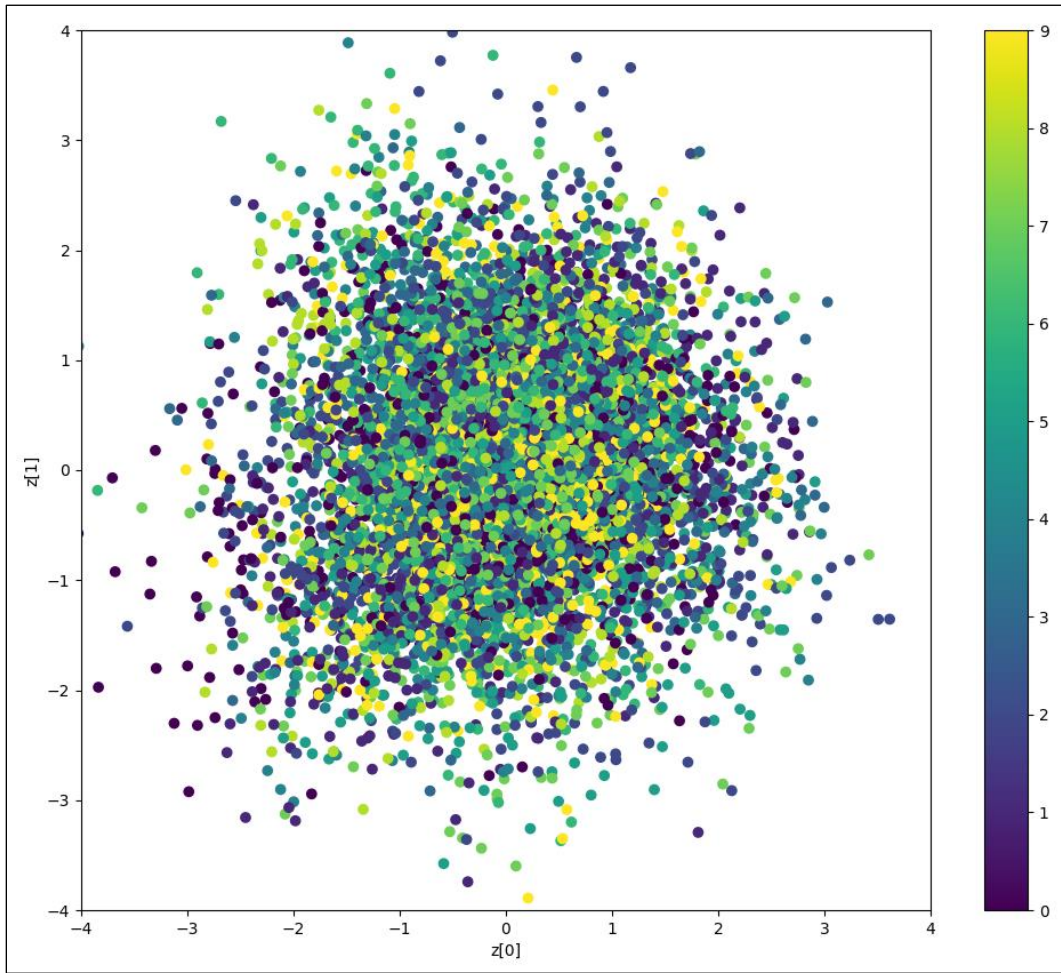

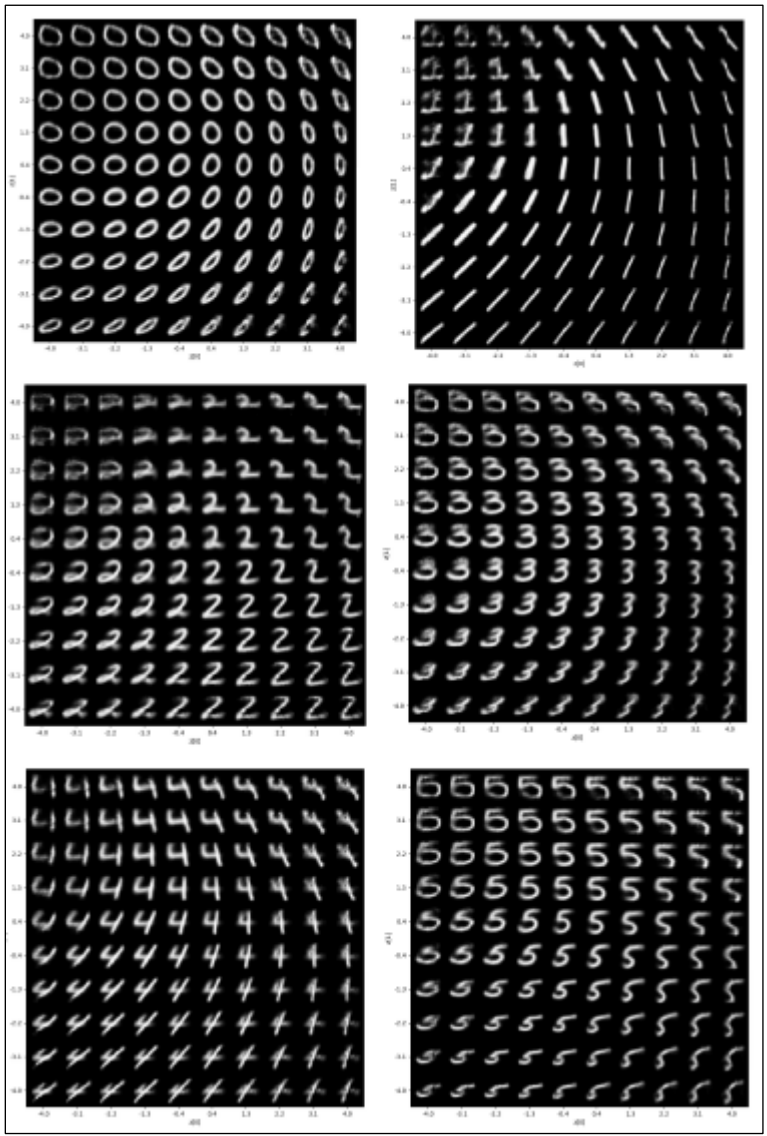

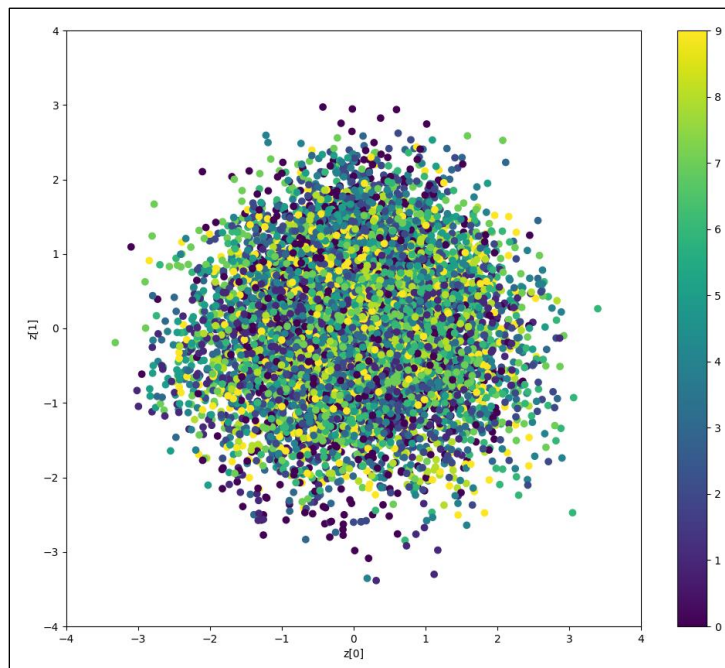
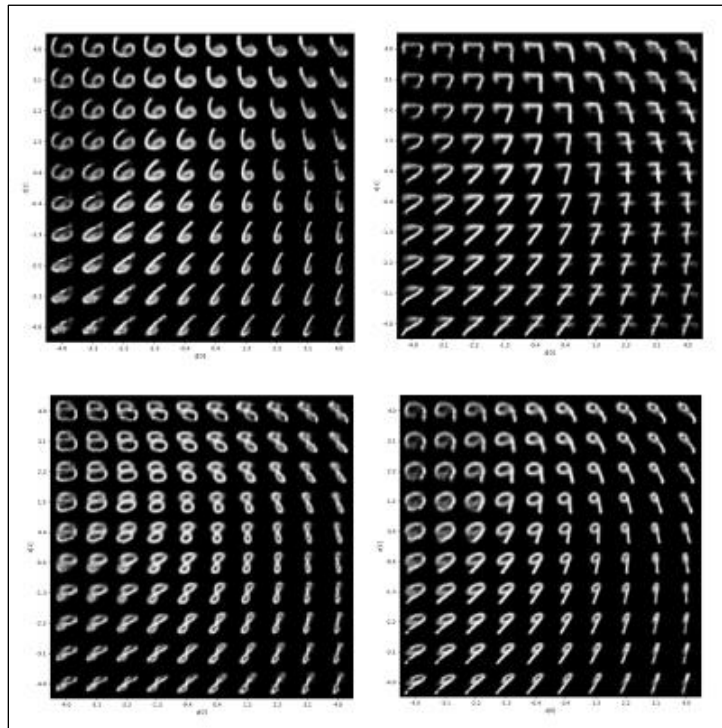

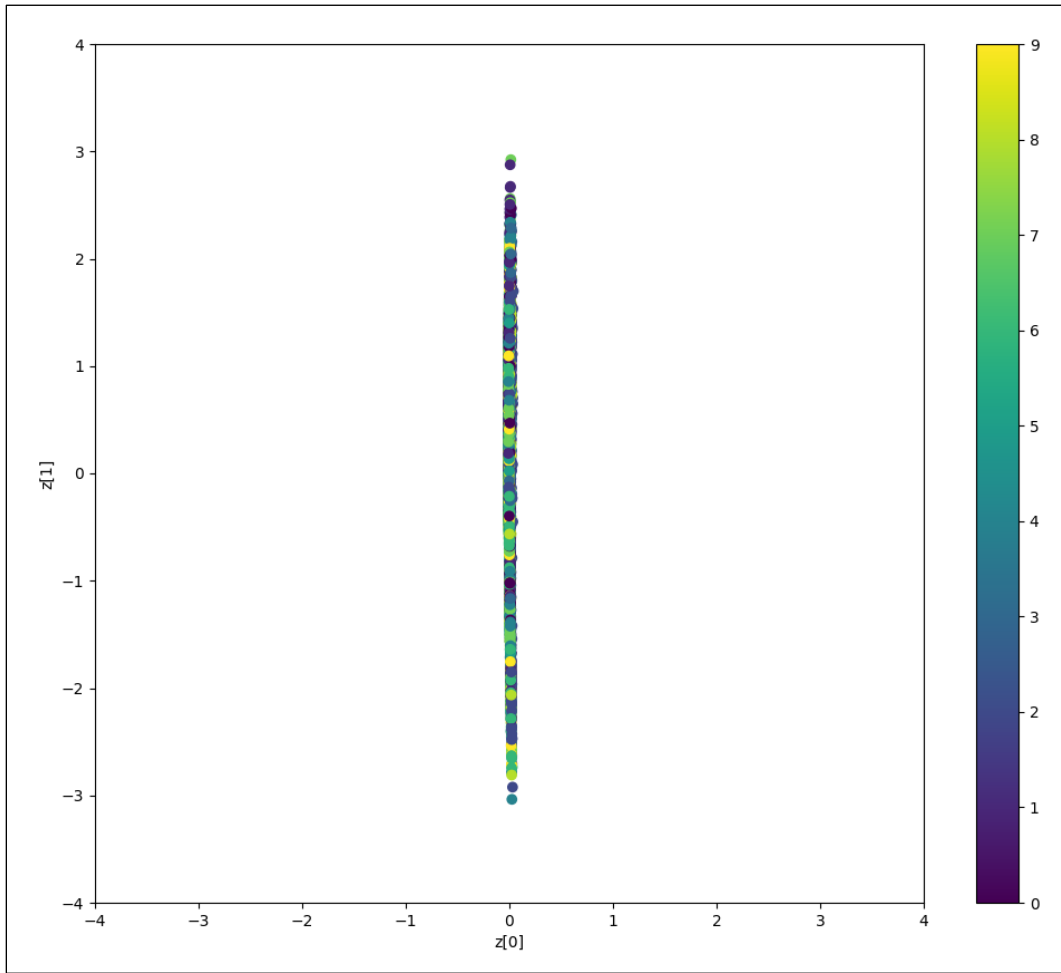

$\beta=1$

$\beta=7$

$\beta=10$

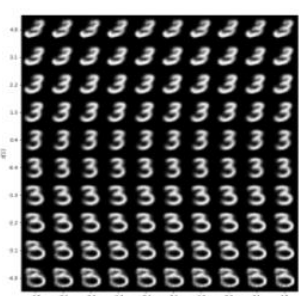
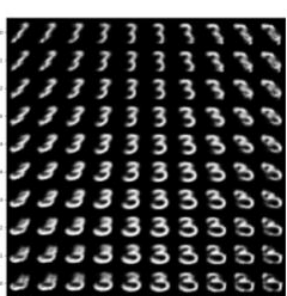
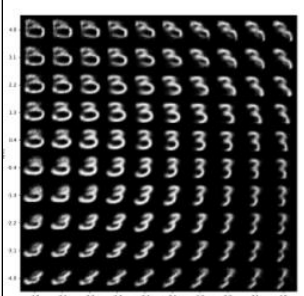
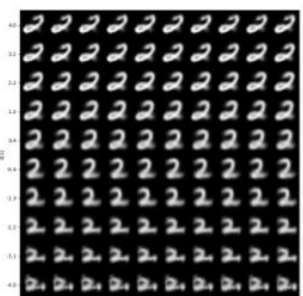
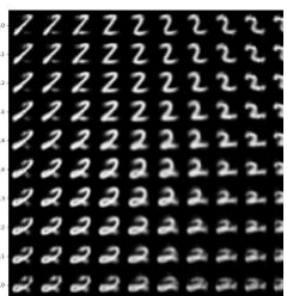
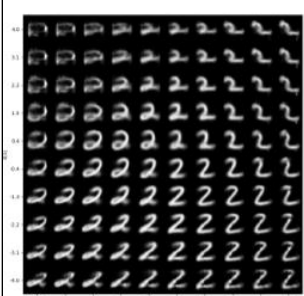
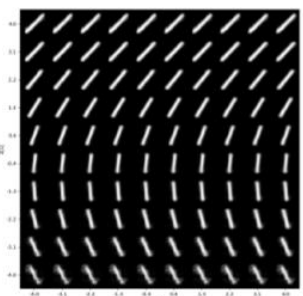
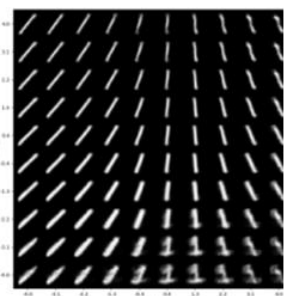
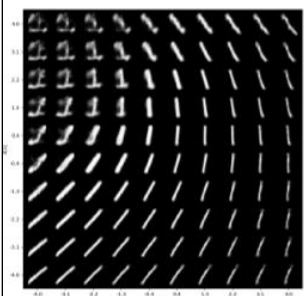
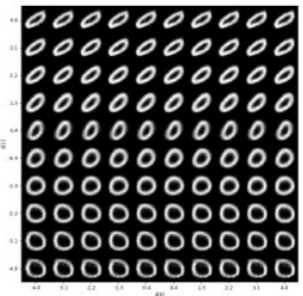
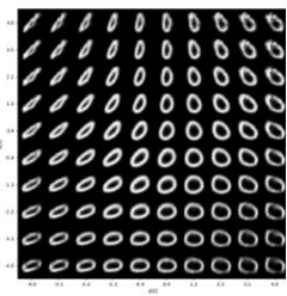
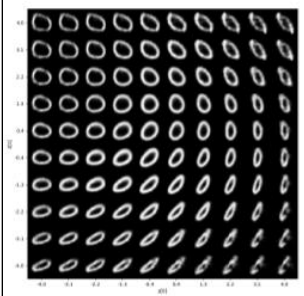

Chapter 9: Deep Reinforcement Learning

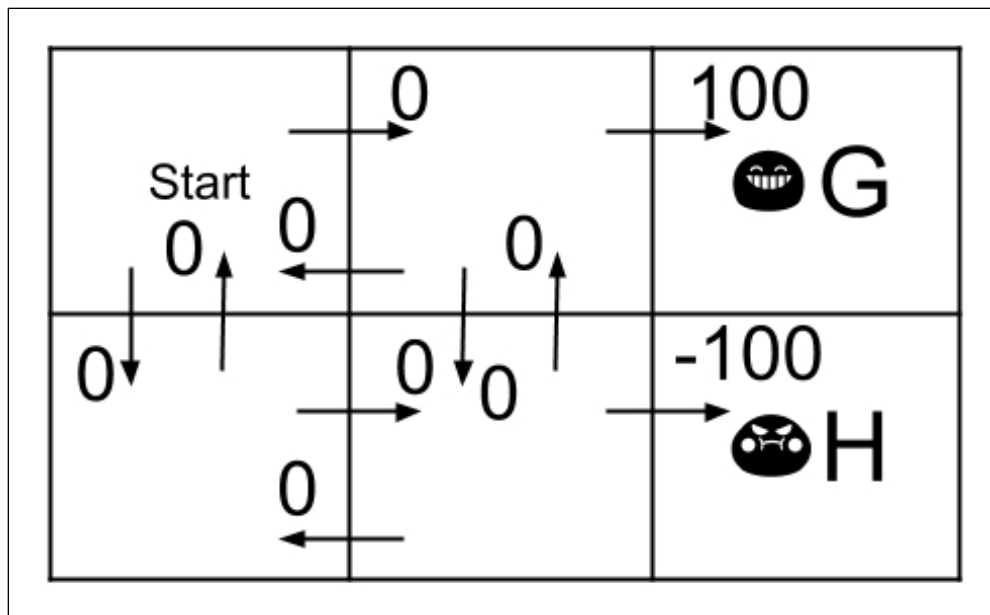
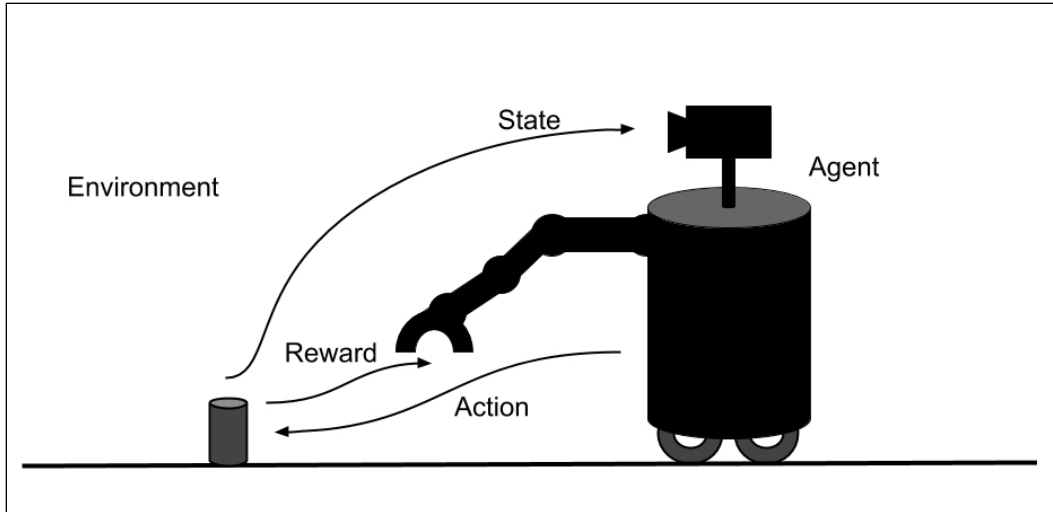

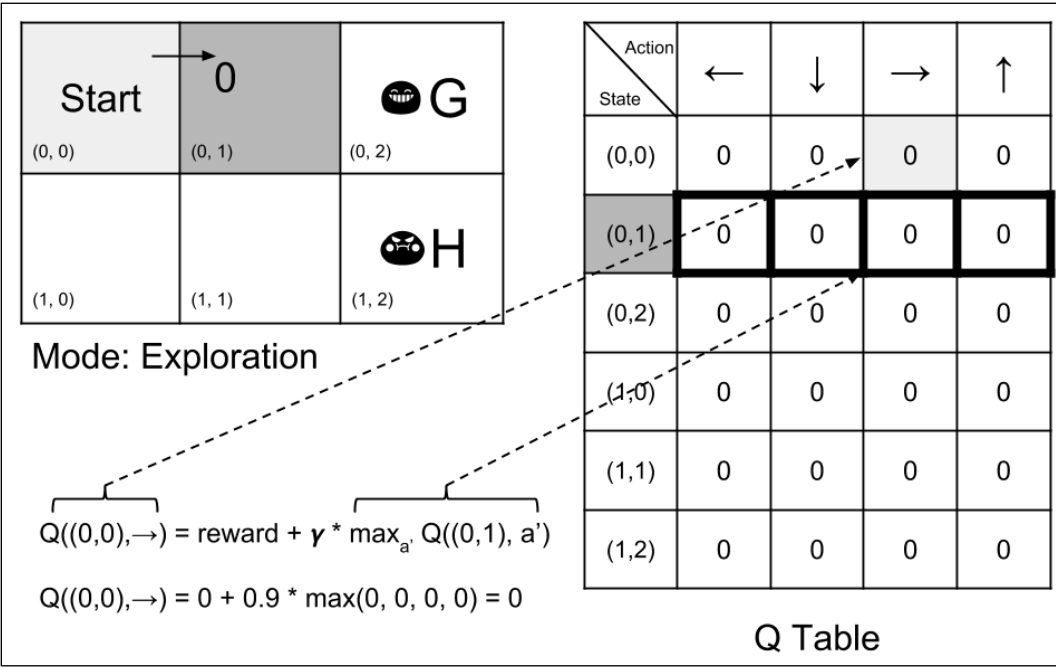

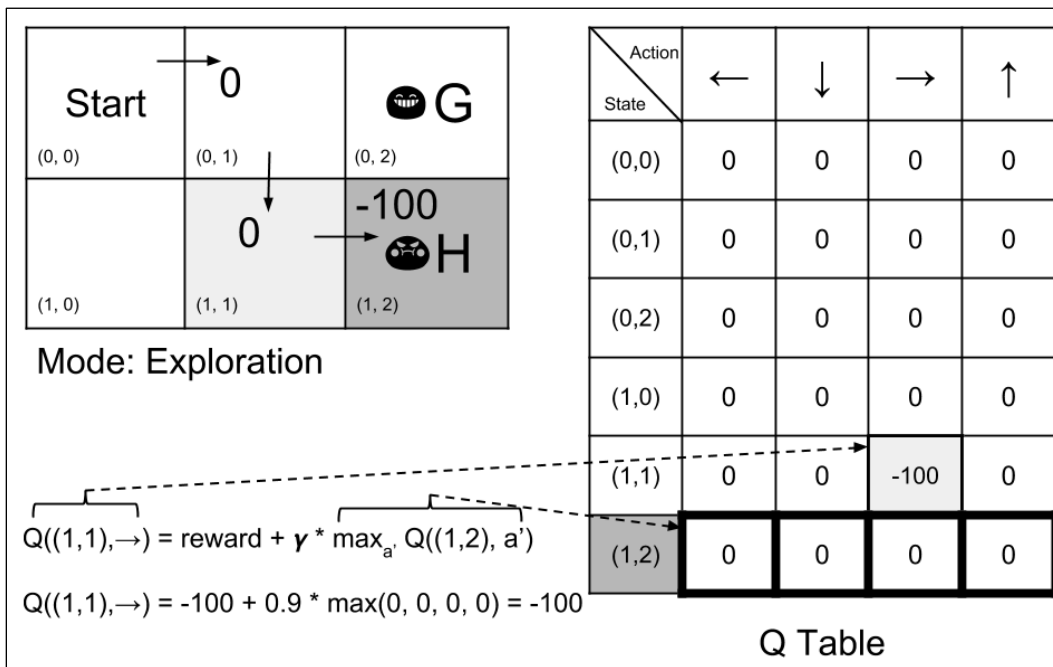
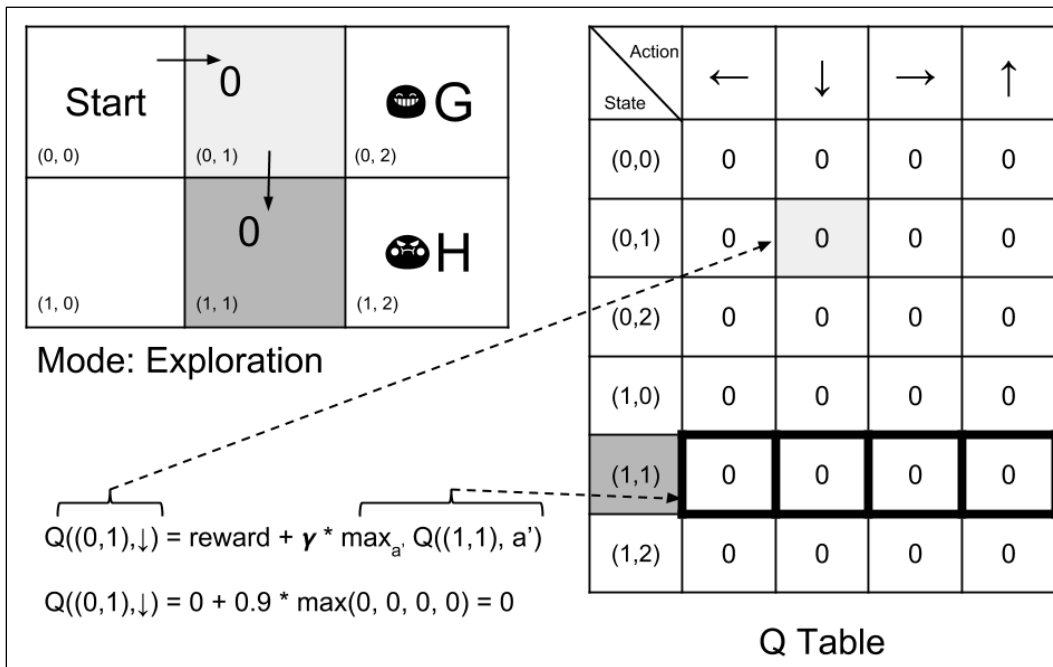

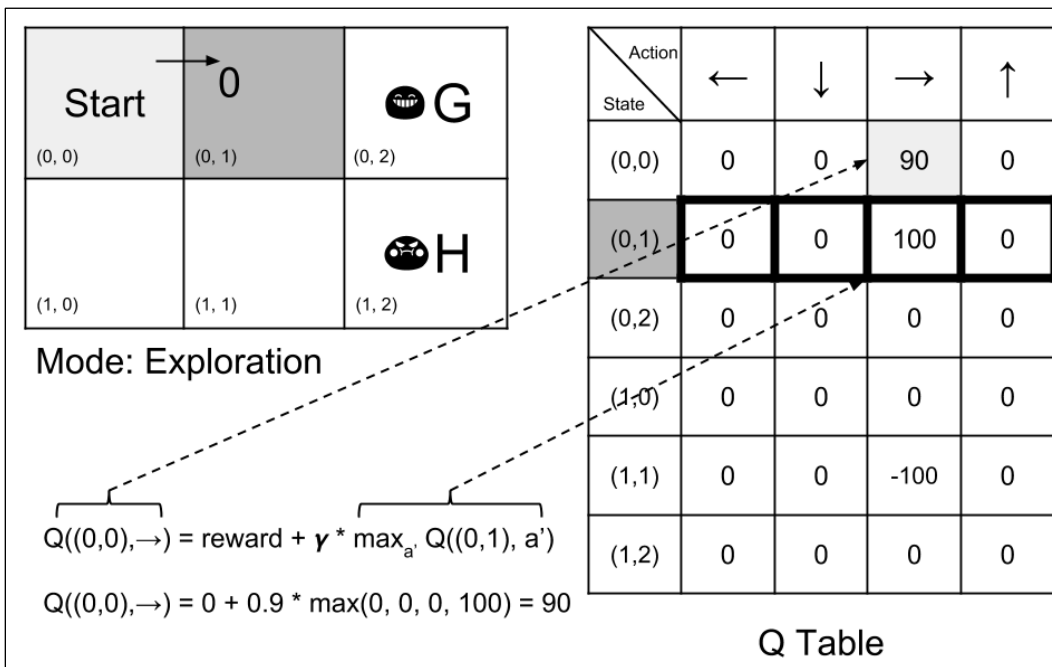
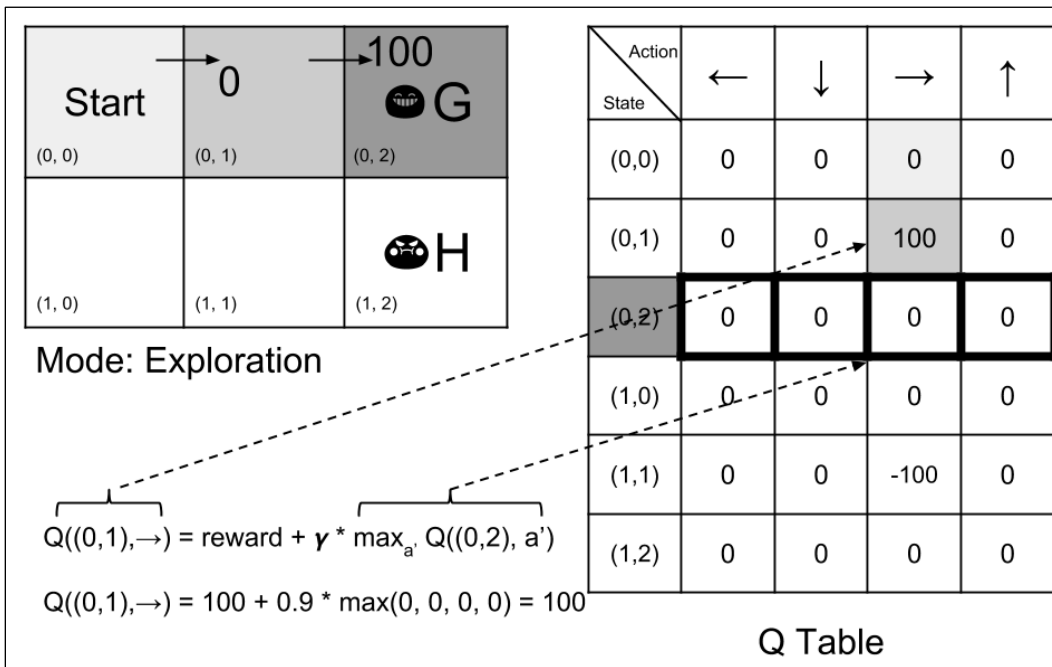

Start (0, 0)	→ 0 (0, 1)	→ 100 G (0, 2)
		H (1, 2)
(1, 0)	(1, 1)	(1, 2)

Mode: Exploitation

$\max_a Q((0,0),a') = 90 \rightarrow$ with $s'=(0,1)$

$\max_a Q((0,1),a') = 100 \rightarrow$ with $s'=(0,2)$ or Goal

Action \ State	←	↓	→	↑
(0,0)	0	0	90	0
(0,1)	0	0	100	0
(0,2)	0	0	0	0
(1,0)	0	0	0	0
(1,1)	0	0	-100	0
(1,2)	0	0	0	0

Q Table

Step 2 : Exploit (Right)

```

-----
|   |   | G |
-----
|   |   | H |
-----

```

Q-Table (Epsilon: 0.10)

```

[[ 81.    72.9   90.    81. ]
 [ 81.    81.   100.   90. ]
 [  0.     0.     0.     0. ]
 [ 72.9   72.9   81.    81. ]
 [ 72.9   81.  -100.   90. ]
 [  0.     0.     0.     0. ]]

```

-----EPISODE DONE-----

Start 90	100	⊙G 0
81	90	⊙H 0

(Right)

SFFF
 FHFH
 FFFH
 HFFG

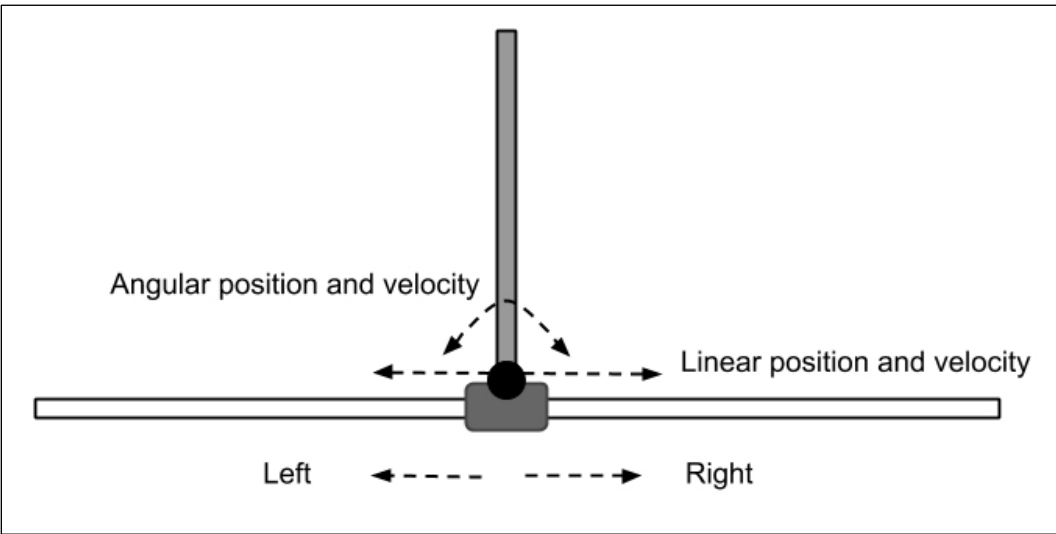
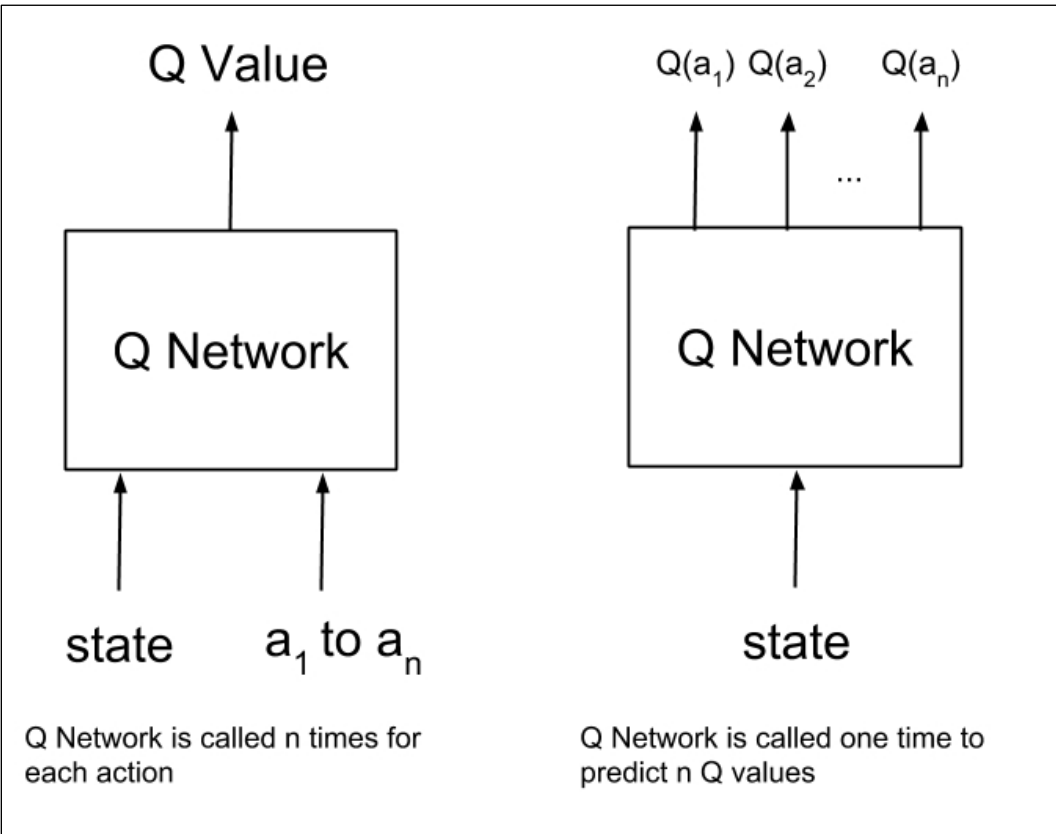

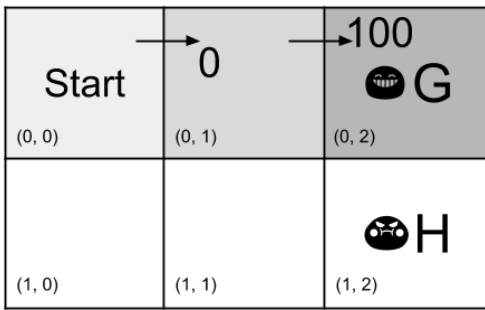

Mode: Exploitation

$\max_a Q((0,0),a') = 90 \rightarrow$ with $s'=(0,1)$

$\max_a Q((0,1),a') = 100 \rightarrow$ with $s'=(0,2)$ or Goal

Action \ State	←	↓	→	↑
(0,0)	0	0	90	0
(0,1)	0	0	100	0
(0,2)	0	0	0	0
(1,0)	0	0	0	0
(1,1)	0	0	-100	0
(1,2)	0	0	0	0

Q Table

Chapter 10: Policy Gradient Methods

